

# ULINE

FALL/WINTER 2023-2024

## SAFETY PRODUCTS

IN STOCK IN ALL 13 LOCATIONS

ORDER BY 6 PM FOR  
SAME DAY SHIPPING

1-800-295-5510  
uline.com



HEARING  
PROTECTION  
PAGES 694-695



MASKS  
PAGES 696-701



EYEWASH  
STATIONS  
PAGES 719-721



FIRST AID  
PAGES 722-725



SAFETY  
GLASSES  
PAGES 688-693



HIGH-VISIBILITY  
CLOTHING  
PAGES 712-718



GLOVES  
PAGES 670-687



FIRE PROTECTION  
PAGES 600-605



SAFETY  
BARRIERS  
PAGES 576-585





## ULINE ADVANTAGE

### SHIPS TODAY

Order by 6 PM for same day shipping.

### IN STOCK

Over 41,000 quality products in stock in all locations to help you run your business.

### SERVICE

Order your way, either online or with a customer service representative, 24 hours a day, 7 days a week!

**13 LOCATIONS ACROSS NORTH AMERICA MEAN FAST DELIVERY. GUARANTEED.**

## HIGH SECURITY SEALS



Lock your high-value cargo up tight.

- Absolute protection from tampering and theft.
- Sequentially numbered.

**TRUCK SEALS**  
Pages 276-278

SPECIFY COLOR: Yellow, Red, Orange, Blue, Green or White

MODEL NO.	COLOR	SIZE W x L	PRICE PER 50		
			1	3	6+
H-435	Specify	3/4 x 3 1/4"	\$79	\$69	\$59

## POLY BAGS



Protect parts and equipment from dirt, dust and moisture.

- 100% virgin, high clarity polyethylene film.
- Over 3,000 poly bag items always in stock.

**POLY BAGS**  
Pages 112-199

### 2 MIL INDUSTRIAL

MODEL NO.	OUTSIDE W x L	QTY./ CTN.	LBS./ CTN.	PRICE PER CARTON			
				1	5	10	20+
S-947	4 x 6"	1,000	3	\$18 per carton any quantity			
S-956	9 x 12"			\$44 per carton any quantity			

## BULK CARGO CONTAINERS



Transfer bulk products from one site to another.

- Easy to load/unload.
- Consolidate several small shipments.

**BOXES**  
Pages 4-85

ONE PALLET INCLUDED PER ORDER

MODEL NO.	INSIDE DIM. L x W x H	TEST	HOLDS MAX. WT.	PRICE EACH (MIN. 5)		
				5	25	100+
S-4480	48 x 40 x 36"	51 ECT DW	100 lbs.	\$25.90 each any qty.		

SHIPS VIA MOTOR FREIGHT

## PLASTIC PAILS



Safely store or ship your products in these durable pails.

- High-density polyethylene construction.

**PAILS**  
Pages 616-617

SPECIFY COLOR: Blue, Gray, Orange, White, Black, Yellow, Green, Red or Natural

MODEL NO.	CAPACITY	MIL	PRICE EACH (MIN. 5)		
			5	10	50+
S-9941	2 Gallon	65	\$4.25	\$3.95	\$3.60
S-7914*	5 Gallon	90	\$6.25 any quantity		

\*Also available in Purple



# ULINE CORRUGATED BOXES – 200 LB. TEST BEST SELLERS

MODEL NO.	INSIDE DIMENSIONS L x W x H	PRICE PER BOX (ANY BNDL. QTY.)	WT./BNDL.	BUNDLE/BALE QTY.
S-4040	4 x 4 x 4"	\$.30	3 lbs.	25 / 2500
S-4050	5 x 5 x 5"	.39	5 lbs.	25 / 1800
S-4060	6 x 4 x 4"	.35	4 lbs.	25 / 2000
S-4061	6 x 6 x 4"	.41	6 lbs.	25 / 1800
S-4062	6 x 6 x 6"	.42	7 lbs.	25 / 1800
S-4080	8 x 6 x 4"	.43	7 lbs.	25 / 1800
S-4082	8 x 8 x 4"	.61	9 lbs.	25 / 1000
S-4084	8 x 8 x 8"	.62	12 lbs.	25 / 900
S-4094	9 x 9 x 9"	.77	16 lbs.	25 / 600
S-4103	10 x 8 x 6"	.66	12 lbs.	25 / 900
S-4105	10 x 10 x 10"	.79	19 lbs.	25 / 500
S-4128	12 x 6 x 6"	.61	11 lbs.	25 / 900
S-4521	12 x 9 x 4"	.79	13 lbs.	25 / 750
S-4406	12 x 9 x 6"	.87	15 lbs.	25 / 750
S-4130	12 x 10 x 6"	.89	17 lbs.	25 / 500
S-4120	12 x 10 x 8"	.91	19 lbs.	25 / 500
S-4215	12 x 12 x 4"	.89	18 lbs.	25 / 500
S-4122	12 x 12 x 6"	.93	20 lbs.	25 / 500
S-4124	12 x 12 x 8"	1.00	23 lbs.	25 / 500
S-4126	12 x 12 x 10"	1.12	25 lbs.	25 / 500
S-4125	12 x 12 x 12"	1.03	27 lbs.	25 / 500
S-4233	14 x 10 x 6"	.91	18 lbs.	25 / 500
S-4144	14 x 10 x 10"	1.00	23 lbs.	25 / 500
S-4142	14 x 14 x 14"	1.62	38 lbs.	25 / 250
S-4318	15 x 15 x 15"	1.86	41 lbs.	25 / 250
S-4235	16 x 12 x 8"	1.22	25 lbs.	25 / 250
S-4160	16 x 12 x 10"	1.34	29 lbs.	25 / 250
S-4163	16 x 12 x 12"	1.42	31 lbs.	25 / 250
S-4393	16 x 16 x 8"	1.60	34 lbs.	25 / 250
S-4166	16 x 16 x 16"	2.04	47 lbs.	25 / 125
S-4187	18 x 12 x 6"	1.37	25 lbs.	25 / 250
S-4188	18 x 12 x 8"	1.41	28 lbs.	25 / 250
S-4189	18 x 12 x 10"	1.44	31 lbs.	25 / 250
S-4181	18 x 12 x 12"	1.48	33 lbs.	25 / 250
S-4183	18 x 14 x 12"	1.78	31 lbs.	20 / 240
S-4399	18 x 18 x 12"	2.21	38 lbs.	20 / 240
S-4185	18 x 18 x 18"	2.55	48 lbs.	20 / 120
S-4204	20 x 12 x 12"	1.69	29 lbs.	20 / 240
S-4542	20 x 14 x 6"	1.56	31 lbs.	25 / 250
S-4206	20 x 14 x 12"	1.94	33 lbs.	20 / 240
S-4200	20 x 16 x 14"	2.36	40 lbs.	20 / 240
S-4210	20 x 20 x 12"	2.58	34 lbs.	15 / 120
S-4201	20 x 20 x 20"	3.30	29 lbs.	10 / 120
S-4243	24 x 12 x 12"	1.84	32 lbs.	20 / 240
S-4218	24 x 16 x 16"	2.75	24 lbs.	10 / 120
S-4219	24 x 18 x 12"	2.70	23 lbs.	10 / 120
S-4340	24 x 18 x 18"	3.39	40 lbs.	15 / 120
S-4320	24 x 24 x 12"	3.44	30 lbs.	10 / 120
■S-4247	24 x 24 x 24"	4.85	42 lbs.	10 / 120
■S-4193	36 x 36 x 36"	10.53	46 lbs.	5 / 120



**OVER 1 BILLION BOXES  
SOLD EVERY YEAR!  
OVER 1,700 STOCK SIZES**

**ORDER BY 6 PM FOR  
SAME DAY SHIPPING**

SOLD IN BUNDLE QUANTITIES

■ SHIPS VIA MOTOR FREIGHT



# ULINE CORRUGATED BOXES

**ORDER BY 6 PM FOR  
SAME DAY SHIPPING**



**OVER 1,700 STOCK SIZES • 13 LOCATIONS • SHIPS FROM CLOSEST LOCATION FOR FASTER DELIVERY**

## THE ULINE ADVANTAGE

### 200 LB. TEST

Stop costly returns due to shipping damage.

- 200 lb. bursting test boxes are up to 30% stronger than 32 ECT boxes.
- Protect your shipment from every angle.

### UPS Experts Speak Out...

200 lb. test boxes handle up to 30% more weight than 32 ECT boxes.

### UPS GUIDELINES

SINGLE WALL BOX TYPE	WEIGHT LIMIT
32 ECT	30 LBS.
<b>200 LB. TEST</b>	<b>40 LBS.</b>

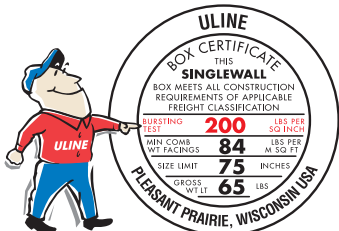

SOLD IN BUNDLE QUANTITIES

MODEL NO.	INSIDE DIM. L x W x H / VARIABLE DEPTH	PRICE PER BOX					BUNDLE/BALE QTY.	WT./BNDL.
		25	100	250	500	1,000+		
S-13287	3 x 3 x 3"	\$.35	\$.34	\$.33	\$.31	\$.29	25 / 3000	2 lbs.
S-16725	4 x 4 x 3"	.37	.35	.34	.33	.31	25 / 2500	3 lbs.
<b>S-4040</b>	<b>4 x 4 x 4"</b>	<b>.30</b>	<b>.30</b>	<b>.30</b>	<b>.30</b>	<b>.30</b>	<b>25 / 2500</b>	<b>3 lbs.</b>
<b>S-22101</b>	<b>4 x 4 x 4"</b>	<b>.23</b>	<b>.23</b>	<b>.23</b>	<b>.23</b>	<b>.23</b>	<b>25 / 2500</b>	<b>3 lbs.</b>
S-4575	4 x 4 x 4"	.43	.42	.41	.37	.35	25 / 2500	3 lbs.
S-19037	4 x 4 x 5"	.50	.44	.42	.39	.37	25 / 2500	4 lbs.
S-4881	4 x 4 x 6"	.51	.45	.43	.40	.38	25 / 1800	4 lbs.
S-4576	4 x 4 x 8"	.54	.50	.48	.43	.42	25 / 1200	5 lbs.
S-19812	4 x 4 x 9"	.66	.64	.60	.55	.54	25 / 1200	6 lbs.
S-11367	4 x 4 x 10"	.82	.75	.69	.65	.62	25 / 1200	6 lbs.
S-4481	4 x 4 x 12"	.96	.84	.77	.72	.69	25 / 1500	7 lbs.
S-16726	4 x 4 x 16"	1.04	.98	.90	.84	.75	25 / 1000	8 lbs.
S-4305	4 x 4 x 18"	1.12	1.04	.96	.92	.80	25 / 1000	9 lbs.
S-4833	4 x 4 x 20"	1.28	1.14	1.04	.99	.92	25 / 1000	10 lbs.
S-4380	4 x 4 x 24"	1.57	1.42	1.19	1.11	1.04	25 / 625	11 lbs.
S-4577	4 x 4 x 28"	1.70	1.50	1.38	1.24	1.17	25 / 500	12 lbs.
S-4578	4 x 4 x 30"	1.71	1.52	1.39	1.25	1.18	25 / 500	13 lbs.
S-19813	4 x 4 x 32"	1.75	1.54	1.42	1.28	1.19	25 / 500	15 lbs.
<b>S-4132</b>	<b>4 x 4 x 36"</b>	<b>1.16</b>	<b>1.16</b>	<b>1.16</b>	<b>1.16</b>	<b>1.16</b>	<b>25 / 500</b>	<b>16 lbs.</b>
S-19814	4 x 4 x 38"	1.85	1.69	1.52	1.38	1.32	25 / 500	17 lbs.
S-4511	4 x 4 x 40"	1.94	1.74	1.58	1.42	1.38	25 / 500	18 lbs.
S-22166	4 x 4 x 46"	2.20	1.99	1.81	1.63	1.58	25 / 625	20 lbs.
<b>S-4465</b>	<b>4 x 4 x 48"</b>	<b>1.62</b>	<b>1.62</b>	<b>1.62</b>	<b>1.62</b>	<b>1.62</b>	<b>25 / 625</b>	<b>21 lbs.</b>
S-4870	4 x 4 x 48 - 90"	4.05	3.74	3.53	3.30	3.13	25 / 625	39 lbs.
S-21584	4 x 4 x 50"	2.67	2.50	2.11	2.02	1.83	25 / 625	22 lbs.
S-4555	4 x 4 x 60"	3.14	2.95	2.50	2.38	2.16	25 / 500	28 lbs.
S-18236	4 x 4 x 72 - 132"	8.25	7.54	6.91	6.47	6.16	25 / 625	64 lbs.
S-4241	4 x 4 x 74"	3.77	3.42	3.14	2.95	2.76	10 / 500	12 lbs.
S-4579	5 x 5 x 3"	.43	.40	.39	.38	.34	25 / 1800	4 lbs.
S-4580	5 x 5 x 4"	.46	.43	.42	.41	.37	25 / 1800	4 lbs.
<b>S-4050</b>	<b>5 x 5 x 5"</b>	<b>.39</b>	<b>.39</b>	<b>.39</b>	<b>.39</b>	<b>.39</b>	<b>25 / 1800</b>	<b>5 lbs.</b>
<b>S-22102</b>	<b>5 x 5 x 5"</b>	<b>.32</b>	<b>.32</b>	<b>.32</b>	<b>.32</b>	<b>.32</b>	<b>25 / 1800</b>	<b>5 lbs.</b>
S-4948	5 x 5 x 5"	.65	.62	.60	.54	.45	25 / 1800	5 lbs.
S-21586	5 x 5 x 6"	.61	.58	.55	.52	.48	25 / 1500	6 lbs.
S-16727	5 x 5 x 8"	.75	.66	.64	.60	.56	25 / 1200	7 lbs.
S-4581	5 x 5 x 10"	.84	.77	.71	.69	.65	25 / 1200	8 lbs.
S-16728	5 x 5 x 12"	.93	.84	.80	.75	.66	25 / 1000	8 lbs.
S-23957	5 x 5 x 24"	1.59	1.44	1.22	1.15	1.08	25 / 500	14 lbs.
S-11368	5 x 5 x 36"	1.79	1.60	1.50	1.42	1.40	25 / 500	20 lbs.



MODEL NO.	INSIDE DIM. L x W x H / VARIABLE DEPTH	PRICE PER BOX					BUNDLE/BALE QTY.	WT./BNDL.	
		25	100	250	500	1,000+			
S-22167	5 x 5 x 40"		\$2.05	\$1.90	\$1.70	\$1.62	\$1.58	25 / 500	22 lbs.
S-19815	5 x 5 x 48"		2.60	2.48	2.08	2.01	1.90	25 / 400	26 lbs.
S-4242	5 x 5 x 50"		2.69	2.53	2.14	2.05	1.94	25 / 400	27 lbs.
S-13284	5 x 5 x 60"		3.74	3.42	2.99	2.79	2.59	20 / 400	24 lbs.
S-4244	6 x 3 x 3"		.44	.41	.39	.35	.34	25 / 2000	3 lbs.
S-20491	6 x 4 x 2"		.44	.41	.39	.35	.34	25 / 2000	3 lbs.
S-4582	6 x 4 x 3"		.45	.42	.41	.37	.35	25 / 1800	4 lbs.
S-4060	6 x 4 x 4"	200 LB. TEST	.35	.35	.35	.35	.35	25 / 2000	4 lbs.
S-22103	6 x 4 x 4"	32 ECT LIGHTWEIGHT	.31	.31	.31	.31	.31	25 / 2000	4 lbs.
S-22630	6 x 4 x 6"		.60	.55	.52	.49	.46	25 / 2000	5 lbs.
S-19038	6 x 4 x 8"		.71	.66	.62	.58	.55	25 / 1500	6 lbs.
S-23286	6 x 5 x 3"	32 ECT LIGHTWEIGHT	.45	.41	.37	.34	.33	25 / 2000	4 lbs.
S-4512	6 x 5 x 4"		.54	.45	.44	.42	.41	25 / 1800	5 lbs.
S-4704	6 x 5 x 5"		.60	.54	.45	.44	.43	25 / 1800	5 lbs.
S-4307	6 x 6 x 2"		.57	.51	.44	.43	.41	25 / 1500	5 lbs.
S-4780	6 x 6 x 3"		.58	.52	.45	.44	.42	25 / 2000	6 lbs.
S-4061	6 x 6 x 4"	200 LB. TEST	.41	.41	.41	.41	.41	25 / 1800	6 lbs.
S-22104	6 x 6 x 4"	32 ECT LIGHTWEIGHT	.33	.33	.33	.33	.33	25 / 1800	5 lbs.
S-18171	6 x 6 x 4"	WHITE	.90	.75	.66	.65	.61	25 / 1800	6 lbs.
S-4513	6 x 6 x 5"		.62	.60	.48	.46	.44	25 / 1500	7 lbs.
S-4062	6 x 6 x 6"	200 LB. TEST	.42	.42	.42	.42	.42	25 / 1800	7 lbs.
S-21014	6 x 6 x 6"	32 ECT LIGHTWEIGHT	.37	.37	.37	.37	.37	25 / 1800	6 lbs.
S-4428	6 x 6 x 6"	WHITE	.96	.84	.72	.69	.65	25 / 1800	7 lbs.
S-4876*	6 x 6 x 6"	275 LB. TEST	.98	.90	.77	.72	.69	25 / 1500	11 lbs.
S-18180*	6 x 6 x 6"	275 LB. TEST DW	1.32	1.22	1.11	1.04	1.01	15 / 675	7 lbs.
S-16729	6 x 6 x 7"		.71	.66	.61	.58	.55	25 / 1800	8 lbs.
S-4882	6 x 6 x 8"		.77	.71	.65	.61	.58	25 / 1200	8 lbs.
S-23948	6 x 6 x 9"	32 ECT LIGHTWEIGHT	.72	.65	.60	.54	.52	25 / 1500	8 lbs.
S-4834	6 x 6 x 10"		.92	.82	.75	.66	.62	25 / 1200	10 lbs.
S-4343	6 x 6 x 12"	GALLON JUG	.98	.86	.79	.70	.66	25 / 1000	11 lbs.
S-19832	6 x 6 x 14"		1.14	1.04	.96	.92	.82	25 / 750	12 lbs.
S-4133	6 x 6 x 18"		1.17	1.05	.99	.94	.84	25 / 750	14 lbs.
S-15026	6 x 6 x 20"		1.31	1.17	1.05	1.02	.94	25 / 500	15 lbs.
S-4332	6 x 6 x 24"		1.60	1.47	1.23	1.17	1.12	25 / 500	17 lbs.
S-4134	6 x 6 x 29"		1.97	1.74	1.61	1.44	1.38	25 / 500	20 lbs.
S-16699	6 x 6 x 30"		2.05	1.85	1.69	1.52	1.42	25 / 500	21 lbs.
S-21015	6 x 6 x 32"		2.13	1.92	1.74	1.58	1.49	25 / 500	22 lbs.
S-4135	6 x 6 x 36"		1.49	1.49	1.49	1.49	1.49	25 / 375	24 lbs.
S-19770*	6 x 6 x 36"	275 LB. TEST DW	4.36	4.00	3.72	3.52	3.32	15 / 225	24 lbs.
S-4583	6 x 6 x 38"		2.32	2.07	1.85	1.71	1.60	25 / 375	25 lbs.
S-4342	6 x 6 x 40"		2.44	2.18	1.98	1.84	1.71	25 / 375	27 lbs.
S-22631	6 x 6 x 42"		2.78	2.50	2.29	2.16	2.01	25 / 375	28 lbs.
S-4381	6 x 6 x 48"		2.14	2.14	2.14	2.14	2.14	25 / 375	31 lbs.
S-13285*	6 x 6 x 48"	275 LB. TEST DW	5.55	5.13	4.76	4.47	4.22	15 / 225	28 lbs.
S-4872	6 x 6 x 48 - 90"	TELESCOPIC	6.16	5.77	5.40	5.13	4.91	25 / 375	58 lbs.
S-19780*	6 x 6 x 48 - 90"	TELESCOPIC, 275 LB. TEST DW	12.57	11.71	10.93	10.31	9.90	15 / 225	59 lbs.
S-20480	6 x 6 x 50"		3.57	3.20	2.89	2.68	2.38	25 / 375	33 lbs.
S-14264	6 x 6 x 60"		4.20	3.75	3.36	3.13	2.76	15 / 480	22 lbs.
S-4136	6 x 6 x 62"		4.47	3.99	3.56	3.30	3.03	15 / 480	24 lbs.
S-4689	6 x 6 x 72"		5.55	5.12	4.68	4.37	4.15	15 / 480	29 lbs.
S-4973	6 x 6 x 72 - 132"	TELESCOPIC	12.02	11.01	10.07	9.42	8.94	15 / 480	52 lbs.
S-22632	7 x 4 x 3"		.53	.44	.42	.39	.35	25 / 2500	4 lbs.
S-4584	7 x 4 x 4"		.54	.45	.43	.40	.36	25 / 1800	4 lbs.
S-13286	7 x 5 x 3"		.58	.45	.44	.42	.41	25 / 1875	5 lbs.
S-4063	7 x 5 x 4"		.60	.46	.45	.43	.42	25 / 1800	5 lbs.
S-4344	7 x 5 x 5"	200 LB. TEST	.42	.42	.42	.42	.42	25 / 1500	6 lbs.
S-22605	7 x 5 x 5"	32 ECT LIGHTWEIGHT	.35	.35	.35	.35	.35	25 / 1800	5 lbs.
S-16700	7 x 6 x 4"		.72	.65	.62	.50	.46	25 / 1500	6 lbs.
S-22171	7 x 6 x 5"		.73	.66	.64	.53	.48	25 / 1500	7 lbs.
S-4974	7 x 6 x 6"		.75	.66	.65	.54	.50	25 / 1500	7 lbs.
S-4585	7 x 7 x 3"		.69	.62	.60	.52	.45	25 / 1200	7 lbs.
S-4690	7 x 7 x 4"		.71	.64	.61	.54	.46	25 / 1200	7 lbs.
S-4070	7 x 7 x 5"	200 LB. TEST	.75	.69	.62	.58	.54	25 / 900	8 lbs.
S-23287	7 x 7 x 5"	32 ECT LIGHTWEIGHT	.64	.58	.52	.49	.45	25 / 1200	7 lbs.



S-4063  
7 x 5 x 4"

**LARGER QUANTITIES  
CALL FOR QUOTE**



S-4343  
6 x 6 x 12"

**SEE RED AND SAVE  
ON POPULAR SIZES !**



S-16610  
4 x 3 x 2"  
INDESTRUCTO

**Kraft and White Indestructos,  
Hundreds of sizes in stock,  
pages 82-85.**

SOLD IN BUNDLE QUANTITIES  
\* 275 LB. TEST  
• 275 LB. TEST DOUBLE WALL (DW)

**MORE BOXES**  
➔





PACKING LIST ENVELOPES  
SEE PAGES 757-762

**LARGER QUANTITIES  
CALL FOR QUOTE**



S-4586  
7 x 7 x 6"

**OVER 1,700 BOX SIZES  
ALWAYS IN STOCK**



S-4592  
8 x 8 x 24"

MODEL NO.	INSIDE DIM. L x W x H	VARIABLE DEPTH	PRICE PER BOX					BUNDLE/BALE QTY.	WT./BNDL.
			25	100	250	500	1,000+		
S-4586	7 x 7 x 6"		\$.80	\$.71	\$.64	\$.61	\$.58	25 / 750	9 lbs.
S-4315	7 x 7 x 7"	200 LB. TEST	.58	.58	.58	.58	.58	25 / 900	10 lbs.
S-19039	7 x 7 x 7"	32 ECT LIGHTWEIGHT	.50	.50	.50	.50	.50	25 / 900	9 lbs.
S-18946	7 x 7 x 7"	WHITE	1.23	1.04	.93	.92	.85	25 / 900	10 lbs.
S-22120*	7 x 7 x 7"	275 LB. TEST DW	1.60	1.46	1.36	1.26	1.22	15 / 450	10 lbs.
S-4514	7 x 7 x 8"		.96	.82	.75	.69	.64	25 / 750	10 lbs.
S-21063	7 x 7 x 9"		.99	.86	.79	.71	.66	25 / 900	11 lbs.
S-4883	7 x 7 x 10"		1.02	.92	.80	.72	.69	25 / 900	12 lbs.
S-4387	7 x 7 x 12"		1.04	.96	.84	.77	.72	25 / 900	13 lbs.
S-18376	7 x 7 x 14"		1.17	1.05	.94	.90	.84	25 / 900	14 lbs.
S-23949	7 x 7 x 48"		3.67	3.31	3.01	2.85	2.64	25 / 375	37 lbs.
S-22628	8 x 3 x 3"		.53	.48	.46	.44	.42	25 / 2250	4 lbs.
S-4245	8 x 4 x 4"	200 LB. TEST	.41	.41	.41	.41	.41	25 / 1875	5 lbs.
S-22173	8 x 4 x 4"	32 ECT LIGHTWEIGHT	.35	.35	.35	.35	.35	25 / 1875	4 lbs.
S-23950	8 x 4 x 8"	32 ECT LIGHTWEIGHT	.72	.66	.64	.56	.53	25 / 1500	6 lbs.
S-20481	8 x 4 x 12"		1.11	1.04	.98	.90	.85	25 / 1125	10 lbs.
S-17997	8 x 4 x 46"	FOL, RIFLE BOX	3.52	3.21	3.09	2.96	2.85	15 / 360	18 lbs.
S-12650	8 x 4 x 52"	FOL, RIFLE BOX	3.14	3.14	3.14	3.14	3.14	15 / 480	21 lbs.
S-16701	8 x 5 x 3"		.69	.62	.58	.45	.44	25 / 1500	5 lbs.
S-4556	8 x 5 x 4"		.71	.64	.60	.46	.45	25 / 1000	7 lbs.
S-4308	8 x 5 x 5"		.72	.65	.62	.54	.46	25 / 1000	7 lbs.
S-15027	8 x 6 x 2"		.41	.41	.41	.41	.41	25 / 1800	6 lbs.
S-4705	8 x 6 x 3"		.71	.64	.60	.46	.45	25 / 1800	7 lbs.
S-4080	8 x 6 x 4"	200 LB. TEST	.43	.43	.43	.43	.43	25 / 1800	7 lbs.
S-19040	8 x 6 x 4"	32 ECT LIGHTWEIGHT	.39	.39	.39	.39	.39	25 / 1800	6 lbs.
S-15028	8 x 6 x 4"	WHITE	.99	.90	.77	.72	.69	25 / 1800	7 lbs.
S-4515	8 x 6 x 5"		.80	.71	.65	.60	.58	25 / 1125	8 lbs.
S-4081	8 x 6 x 6"	200 LB. TEST	.57	.57	.57	.57	.57	25 / 1200	8 lbs.
S-19041	8 x 6 x 6"	32 ECT LIGHTWEIGHT	.48	.48	.48	.48	.48	25 / 1200	7 lbs.
S-16702	8 x 6 x 8"		.87	.80	.77	.75	.72	25 / 900	10 lbs.
S-23951	8 x 6 x 10"	32 ECT LIGHTWEIGHT	.85	.79	.75	.72	.69	25 / 1125	9 lbs.
S-4588	8 x 7 x 7"		.92	.84	.82	.80	.77	25 / 900	11 lbs.
S-19042	8 x 8 x 2"		.72	.69	.66	.65	.62	25 / 1800	8 lbs.
S-4589	8 x 8 x 3"		.75	.71	.69	.66	.64	25 / 1000	8 lbs.
S-4082	8 x 8 x 4"	200 LB. TEST	.61	.61	.61	.61	.61	25 / 1000	9 lbs.
S-19043	8 x 8 x 4"	32 ECT LIGHTWEIGHT	.52	.52	.52	.52	.52	25 / 1200	8 lbs.
S-4345	8 x 8 x 5"	200 LB. TEST	.82	.77	.75	.72	.71	25 / 750	10 lbs.
S-23303	8 x 8 x 5"	32 ECT LIGHTWEIGHT	.68	.66	.64	.61	.60	25 / 900	9 lbs.
S-4083	8 x 8 x 6"	200 LB. TEST	.71	.71	.71	.71	.71	25 / 750	11 lbs.
S-19044	8 x 8 x 6"	32 ECT LIGHTWEIGHT	.60	.60	.60	.60	.60	25 / 900	9 lbs.
S-18947	8 x 8 x 6"	WHITE	1.25	1.05	.96	.94	.90	25 / 750	11 lbs.
S-4975	8 x 8 x 7"		1.02	.92	.84	.82	.77	25 / 900	12 lbs.
S-4084	8 x 8 x 8"	200 LB. TEST	.62	.62	.62	.62	.62	25 / 900	12 lbs.
S-18336	8 x 8 x 8"	32 ECT LIGHTWEIGHT	.53	.53	.53	.53	.53	25 / 900	10 lbs.
S-4706	8 x 8 x 8"	8,7,6,5,4"	1.23	1.04	.98	.96	.90	25 / 900	12 lbs.
S-4429	8 x 8 x 8"	WHITE	1.29	1.08	.99	.98	.92	25 / 900	12 lbs.
S-4591*	8 x 8 x 8"	275 LB. TEST	1.36	1.18	1.04	.99	.94	25 / 750	17 lbs.
S-4815*	8 x 8 x 8"	275 LB. TEST DW	1.85	1.70	1.60	1.49	1.42	15 / 450	12 lbs.
S-16703	8 x 8 x 9"		1.08	.99	.92	.90	.77	25 / 900	13 lbs.
S-4516	8 x 8 x 10"		1.17	1.04	.96	.94	.84	25 / 750	14 lbs.
S-19862	8 x 8 x 11"		1.19	1.05	.98	.94	.86	25 / 750	15 lbs.
S-4814	8 x 8 x 12"		1.24	1.06	.99	.96	.90	25 / 500	16 lbs.
S-4691	8 x 8 x 14"		1.29	1.12	1.04	.98	.92	25 / 500	17 lbs.
S-4333	8 x 8 x 17"		1.44	1.36	1.18	1.05	1.02	25 / 500	19 lbs.
S-20492	8 x 8 x 18"		1.50	1.40	1.24	1.12	1.05	25 / 500	20 lbs.
S-15029	8 x 8 x 20"		1.63	1.50	1.34	1.22	1.11	25 / 250	21 lbs.
S-4592	8 x 8 x 24"		2.16	1.97	1.79	1.65	1.52	25 / 250	24 lbs.
S-4923	8 x 8 x 30"		2.36	2.10	1.97	1.74	1.65	25 / 250	27 lbs.
S-4483	8 x 8 x 36"		2.54	2.26	2.07	1.88	1.79	25 / 250	32 lbs.
S-21008	8 x 8 x 38"		3.00	2.75	2.49	2.29	2.16	25 / 250	35 lbs.
S-4781	8 x 8 x 40"		3.32	3.02	2.73	2.54	2.38	20 / 240	27 lbs.
S-16704	8 x 8 x 42"		3.66	3.35	3.09	2.85	2.69	20 / 240	30 lbs.
S-4557	8 x 8 x 48"		2.84	2.84	2.84	2.84	2.84	20 / 240	38 lbs.
S-4921	8 x 8 x 48 - 90"	TELESCOPIC	8.63	8.13	7.60	7.20	6.88	20 / 240	76 lbs.

SOLD IN BUNDLE QUANTITIES

\* 275 LB. TEST

• 275 LB. TEST DOUBLE WALL (DW)

FOL = FULL OVERLAP



MODEL NO.	INSIDE DIM. L x W x H / VARIABLE DEPTH	PRICE PER BOX					BUNDLE/BALE QTY.	WT./BNDL.
		25	100	250	500	1,000+		
S-20429*	8 x 8 x 48 - 90" TELESCOPIC, 275 LB. TEST DW	\$17.51	\$16.41	\$15.25	\$14.38	\$13.65	15 / 225	77 lbs.
S-21009	8 x 8 x 50"	4.41	4.18	3.58	3.45	3.14	20 / 240	35 lbs.
S-4835	8 x 8 x 60"	5.18	4.91	4.21	4.05	3.67	15 / 360	32 lbs.
S-19863	8 x 8 x 72"	6.66	6.23	5.73	5.46	5.16	15 / 360	36 lbs.
S-18952	8 x 8 x 72 - 132" TELESCOPIC	15.97	14.61	13.40	12.52	11.92	15 / 240	74 lbs.
S-4850	9 x 4 x 3"	.61	.48	.45	.44	.43	25 / 1800	5 lbs.
S-15030	9 x 4 x 4"	.62	.54	.46	.45	.44	25 / 1800	5 lbs.
S-4593	9 x 5 x 3"	.62	.54	.48	.45	.44	25 / 1800	6 lbs.
S-16705	9 x 5 x 4"	.64	.55	.50	.46	.45	25 / 1800	6 lbs.
S-4092	9 x 5 x 5"	.67	.58	.53	.49	.48	25 / 1800	7 lbs.
S-11369	9 x 6 x 2"	.71	.65	.60	.54	.50	25 / 1800	7 lbs.
S-4949	9 x 6 x 3" 200 LB. TEST	.50	.50	.50	.50	.50	25 / 1800	7 lbs.
S-22174	9 x 6 x 3" 32 ECT LIGHTWEIGHT	.41	.41	.41	.41	.41	25 / 1800	6 lbs.
S-4484	9 x 6 x 4" 200 LB. TEST	.51	.51	.51	.51	.51	25 / 1500	7 lbs.
S-19864	9 x 6 x 4" 32 ECT LIGHTWEIGHT	.42	.42	.42	.42	.42	25 / 1800	6 lbs.
S-4707	9 x 6 x 5"	.77	.71	.64	.61	.58	25 / 1000	8 lbs.
S-4362	9 x 6 x 6" 200 LB. TEST	.57	.57	.57	.57	.57	25 / 750	9 lbs.
S-19865	9 x 6 x 6" 32 ECT LIGHTWEIGHT	.48	.48	.48	.48	.48	25 / 1200	8 lbs.
S-19866	9 x 6 x 7"	.90	.82	.72	.66	.64	25 / 900	10 lbs.
S-18383	9 x 6 x 9"	.98	.93	.80	.72	.69	25 / 900	11 lbs.
S-19100	9 x 7 x 3"	.75	.69	.62	.60	.56	25 / 1800	8 lbs.
S-4594	9 x 7 x 4" 200 LB. TEST	.77	.71	.64	.61	.58	25 / 1200	8 lbs.
S-22175	9 x 7 x 4" 32 ECT LIGHTWEIGHT	.64	.60	.54	.50	.48	25 / 1200	8 lbs.
S-4334	9 x 7 x 5" 200 LB. TEST	.80	.72	.65	.62	.60	25 / 900	9 lbs.
S-19867	9 x 7 x 5" 32 ECT LIGHTWEIGHT	.65	.61	.55	.52	.50	25 / 1200	8 lbs.
S-4976	9 x 7 x 6"	.84	.77	.69	.64	.61	25 / 900	10 lbs.
S-4485	9 x 7 x 7"	.94	.84	.77	.69	.65	25 / 750	11 lbs.
S-4836	9 x 8 x 4"	.80	.72	.65	.62	.60	25 / 1200	10 lbs.
S-4950	9 x 8 x 6"	.92	.82	.72	.69	.65	25 / 900	12 lbs.
S-16706	9 x 8 x 8"	1.02	.94	.87	.77	.71	25 / 900	13 lbs.
S-20493	9 x 9 x 3"	.87	.79	.69	.65	.62	25 / 900	11 lbs.
S-4595	9 x 9 x 4" 200 LB. TEST	.60	.60	.60	.60	.60	25 / 750	12 lbs.
S-21587	9 x 9 x 4" 32 ECT LIGHTWEIGHT	.51	.51	.51	.51	.51	25 / 900	10 lbs.
S-4093	9 x 9 x 5" 200 LB. TEST	.92	.82	.72	.69	.65	25 / 900	12 lbs.
S-22176	9 x 9 x 5" 32 ECT LIGHTWEIGHT	.79	.69	.61	.58	.55	25 / 900	10 lbs.
S-4309	9 x 9 x 6" 200 LB. TEST	.99	.94	.82	.75	.71	25 / 900	13 lbs.
S-21011	9 x 9 x 6" 32 ECT LIGHTWEIGHT	.84	.80	.66	.62	.60	25 / 900	11 lbs.
S-16515*	9 x 9 x 6 1/2" 275 LB. TEST DW	1.95	1.79	1.65	1.58	1.50	15 / 450	13 lbs.
S-4596	9 x 9 x 7"	1.04	.98	.92	.82	.75	25 / 600	14 lbs.
S-14265	9 x 9 x 8"	1.11	1.04	.96	.90	.80	25 / 600	14 lbs.
S-4094	9 x 9 x 9" 200 LB. TEST	.77	.77	.77	.77	.77	25 / 600	16 lbs.
S-19059	9 x 9 x 9" 32 ECT LIGHTWEIGHT	.62	.62	.62	.62	.62	25 / 600	14 lbs.
S-16454	9 x 9 x 9" WHITE	1.40	1.24	1.06	1.04	.99	25 / 600	16 lbs.
S-20408*	9 x 9 x 9" 275 LB. TEST DW	2.26	2.13	1.96	1.84	1.74	15 / 300	15 lbs.
S-16707	9 x 9 x 10"	1.28	1.17	.99	.94	.90	25 / 600	16 lbs.
S-4597	9 x 9 x 11"	1.40	1.29	1.05	1.02	.98	25 / 500	17 lbs.
S-19856	9 x 9 x 12"	1.44	1.36	1.11	1.04	1.02	25 / 500	18 lbs.
S-4816*	9 x 9 x 12 1/2" 275 LB. TEST DW	2.60	2.43	2.26	2.11	2.02	15 / 300	17 lbs.
S-4598	9 x 9 x 18"	1.79	1.61	1.42	1.34	1.23	25 / 250	22 lbs.
S-4599	9 x 9 x 30"	2.50	2.18	2.02	1.84	1.73	25 / 250	36 lbs.
S-21010	9 x 9 x 36"	2.68	2.44	2.22	2.11	1.97	25 / 250	38 lbs.
S-21585	9 x 9 x 48"	3.94	3.79	3.53	3.42	3.30	20 / 240	38 lbs.
S-4466	10 x 4 x 4" 200 LB. TEST	.51	.51	.51	.51	.51	25 / 1875	5 lbs.
S-22177	10 x 4 x 4" 32 ECT LIGHTWEIGHT	.42	.42	.42	.42	.42	25 / 1875	5 lbs.
S-20478	10 x 5 x 4"	.83	.75	.66	.62	.58	25 / 1800	7 lbs.
S-4486	10 x 5 x 5" 200 LB. TEST	.84	.77	.69	.64	.60	25 / 1500	8 lbs.
S-23302	10 x 5 x 5" 32 ECT LIGHTWEIGHT	.72	.66	.60	.54	.50	25 / 1800	6 lbs.
S-23288	10 x 6 x 2" 32 ECT LIGHTWEIGHT	.65	.60	.54	.50	.46	25 / 1800	6 lbs.
S-4600	10 x 6 x 3"	.80	.72	.64	.61	.56	25 / 1200	7 lbs.
S-4101	10 x 6 x 4" 200 LB. TEST	.55	.55	.55	.55	.55	25 / 1200	8 lbs.
S-19060	10 x 6 x 4" 32 ECT LIGHTWEIGHT	.48	.48	.48	.48	.48	25 / 1800	7 lbs.
S-4951	10 x 6 x 5"	.90	.80	.71	.65	.60	25 / 1200	8 lbs.
S-4102	10 x 6 x 6" 200 LB. TEST	.58	.58	.58	.58	.58	25 / 900	9 lbs.
S-19061	10 x 6 x 6" 32 ECT LIGHTWEIGHT	.50	.50	.50	.50	.50	25 / 1200	8 lbs.



S-4084  
8 x 8 x 8"

\$ .62 per box any bundle qty.

**ORDER BY 6 PM FOR  
SAME DAY SHIPPING**



S-4094  
9 x 9 x 9"

\$ .77 per box any bundle qty.

**SEE RED AND SAVE  
ON POPULAR SIZES !**



S-4599  
9 x 9 x 30"

SOLD IN BUNDLE QUANTITIES  
• 275 LB. TEST DOUBLE WALL (DW)

**MORE BOXES**  
→



**ORDER BY 6 PM FOR  
SAME DAY SHIPPING**



**S-4105**  
10 x 10 x 10"

**\$.79 per box any bundle qty.**



**S-4604**  
10 x 10 x 24"

MODEL NO.	INSIDE DIM. L x W x H / VARIABLE DEPTH	PRICE PER BOX					BUNDLE/BALE QTY.	WT./BNDL.
		25	100	250	500	1,000+		
S-12590	10 x 6 x 57 - 108" TELESCOPIC, SKI BOX	\$10.80	\$10.42	\$9.79	\$9.19	\$8.44	15 / 360	56 lbs.
S-23952	10 x 7 x 2" 32 ECT LIGHTWEIGHT	.73	.65	.60	.56	.54	25 / 1500	6 lbs.
S-16708	10 x 7 x 3"	.83	.75	.66	.65	.61	25 / 1200	8 lbs.
S-4708	10 x 7 x 4"	.90	.80	.71	.69	.62	25 / 750	8 lbs.
S-4752	10 x 7 x 5" 200 LB. TEST	.92	.82	.72	.71	.64	25 / 750	9 lbs.
S-22629	10 x 7 x 5" 32 ECT LIGHTWEIGHT	.77	.68	.61	.58	.55	25 / 1200	8 lbs.
S-4782	10 x 7 x 7" 200 LB. TEST	.96	.84	.77	.72	.69	25 / 750	11 lbs.
S-23304	10 x 7 x 7" 32 ECT LIGHTWEIGHT	.82	.72	.65	.61	.60	25 / 900	10 lbs.
S-21062	10 x 7 x 9"	1.05	.93	.85	.80	.75	25 / 900	13 lbs.
S-4601	10 x 8 x 2"	.84	.75	.69	.66	.64	25 / 1200	10 lbs.
S-4851	10 x 8 x 3"	.86	.77	.71	.66	.65	25 / 1200	11 lbs.
S-4310	10 x 8 x 4" 200 LB. TEST	.62	.62	.62	.62	.62	25 / 900	11 lbs.
S-21012	10 x 8 x 4" 32 ECT LIGHTWEIGHT	.53	.53	.53	.53	.53	25 / 1200	9 lbs.
S-4517	10 x 8 x 5" 200 LB. TEST	.94	.82	.75	.71	.66	25 / 900	11 lbs.
S-22178	10 x 8 x 5" 32 ECT LIGHTWEIGHT	.79	.69	.62	.60	.58	25 / 900	10 lbs.
S-4103	10 x 8 x 6" 200 LB. TEST	.66	.66	.66	.66	.66	25 / 900	12 lbs.
S-18337	10 x 8 x 6" 32 ECT LIGHTWEIGHT	.57	.57	.57	.57	.57	25 / 900	10 lbs.
S-14261	10 x 8 x 6" WHITE	1.34	1.12	1.04	.99	.93	25 / 900	12 lbs.
S-16709*	10 x 8 x 6" 275 LB. TEST	1.42	1.25	1.08	1.04	.99	25 / 750	17 lbs.
S-4518	10 x 8 x 7"	.98	.90	.80	.75	.71	25 / 500	13 lbs.
S-4104	10 x 8 x 8" 200 LB. TEST	.68	.68	.68	.68	.68	25 / 500	14 lbs.
S-19062	10 x 8 x 8" 32 ECT LIGHTWEIGHT	.59	.59	.59	.59	.59	25 / 900	12 lbs.
S-17994	10 x 8 x 8" 8,6,4"	1.34	1.12	1.04	1.02	.96	25 / 500	14 lbs.
S-23958*	10 x 8 x 8" 275 LB. TEST DW	2.07	1.90	1.79	1.65	1.59	15 / 450	14 lbs.
S-22638	10 x 8 x 9"	1.12	.94	.90	.79	.75	25 / 600	15 lbs.
S-16710	10 x 8 x 10"	1.17	.98	.94	.82	.77	25 / 600	16 lbs.
S-19101	10 x 8 x 12"	1.32	1.12	1.01	.98	.92	25 / 500	17 lbs.
S-16711	10 x 9 x 4"	1.01	.90	.82	.72	.66	25 / 900	12 lbs.
S-4977	10 x 9 x 6"	1.04	.96	.92	.80	.77	25 / 900	14 lbs.
S-19102	10 x 9 x 8"	1.32	1.17	1.01	.93	.92	25 / 500	16 lbs.
S-4519	10 x 9 x 9"	1.39	1.24	1.04	.98	.96	25 / 500	16 lbs.
S-4942	10 x 10 x 2"	.98	.93	.79	.69	.66	25 / 1200	12 lbs.
S-4311	10 x 10 x 3"	.99	.94	.80	.71	.69	25 / 500	13 lbs.
S-4346	10 x 10 x 4" 200 LB. TEST	.68	.68	.68	.68	.68	25 / 500	13 lbs.
S-20460	10 x 10 x 4" 32 ECT LIGHTWEIGHT	.57	.57	.57	.57	.57	25 / 900	11 lbs.
S-4106	10 x 10 x 5" 200 LB. TEST	1.04	.98	.90	.77	.72	25 / 500	14 lbs.
S-21588	10 x 10 x 5" 32 ECT LIGHTWEIGHT	.87	.83	.77	.64	.61	25 / 900	12 lbs.
S-4107	10 x 10 x 6" 200 LB. TEST	.71	.71	.71	.71	.71	25 / 500	15 lbs.
S-19857	10 x 10 x 6" 32 ECT LIGHTWEIGHT	.59	.59	.59	.59	.59	25 / 900	13 lbs.
S-20409*	10 x 10 x 6" 275 LB. TEST DW	2.14	1.97	1.84	1.73	1.63	15 / 450	15 lbs.
S-4558	10 x 10 x 7"	1.12	.99	.96	.82	.77	25 / 500	16 lbs.
S-4108	10 x 10 x 8" 200 LB. TEST	1.23	1.02	.98	.84	.80	25 / 500	17 lbs.
S-19858	10 x 10 x 8" 32 ECT LIGHTWEIGHT	1.04	.86	.83	.69	.65	25 / 600	14 lbs.
S-4978	10 x 10 x 9"	1.24	1.04	.99	.90	.82	25 / 500	18 lbs.
S-4105	10 x 10 x 10" 200 LB. TEST	.79	.79	.79	.79	.79	25 / 500	19 lbs.
S-18338	10 x 10 x 10" 32 ECT LIGHTWEIGHT	.63	.63	.63	.63	.63	25 / 600	16 lbs.
S-535	10 x 10 x 10" 10,8,6"	1.52	1.42	1.36	1.29	1.23	25 / 500	19 lbs.
S-4430	10 x 10 x 10" WHITE	1.50	1.39	1.17	1.08	1.04	25 / 500	19 lbs.
S-4603*	10 x 10 x 10" 275 LB. TEST	1.63	1.52	1.42	1.39	1.29	25 / 500	26 lbs.
S-4953*	10 x 10 x 10" 275 LB. TEST DW	2.68	2.51	2.32	2.17	2.07	15 / 300	18 lbs.
S-14266	10 x 10 x 12"	1.44	1.36	1.24	1.12	1.04	25 / 500	20 lbs.
S-4520	10 x 10 x 12" 12,10,8,6"	1.88	1.79	1.61	1.57	1.44	25 / 500	20 lbs.
S-16712	10 x 10 x 14"	1.62	1.46	1.38	1.34	1.32	25 / 500	23 lbs.
S-4246	10 x 10 x 15"	1.69	1.50	1.42	1.39	1.38	25 / 500	23 lbs.
S-21593	10 x 10 x 16"	1.74	1.54	1.46	1.42	1.39	25 / 500	25 lbs.
S-16713	10 x 10 x 18"	1.85	1.64	1.57	1.46	1.42	25 / 250	26 lbs.
S-11370	10 x 10 x 20"	1.97	1.74	1.64	1.52	1.44	25 / 250	28 lbs.
S-4604	10 x 10 x 24"	2.18	2.02	1.84	1.69	1.57	25 / 250	32 lbs.
S-14267	10 x 10 x 30"	2.61	2.40	2.21	2.05	1.92	25 / 250	36 lbs.
S-4605	10 x 10 x 36"	2.73	2.54	2.33	2.29	2.11	25 / 250	40 lbs.
S-4753	10 x 10 x 38"	2.95	2.76	2.59	2.44	2.33	25 / 250	42 lbs.
S-16714	10 x 10 x 40"	3.94	3.67	3.30	3.13	2.82	25 / 250	46 lbs.
S-4606	10 x 10 x 48"	4.86	4.59	4.01	3.82	3.55	20 / 240	47 lbs.
S-4919	10 x 10 x 48 - 90" TELESCOPIC	9.65	9.30	8.66	8.26	7.86	20 / 240	94 lbs.

SOLD IN BUNDLE QUANTITIES

\* 275 LB. TEST

• 275 LB. TEST DOUBLE WALL (DW)



MODEL NO.	INSIDE DIM. L x W x H / VARIABLE DEPTH	PRICE PER BOX					BUNDLE/BALE QTY.	WT./BNDL.	
		25	100	250	500	1,000+			
S-13288	10 x 10 x 60"		\$6.14	\$5.77	\$5.20	\$4.98	\$4.55	15 / 240	37 lbs.
■S-18384	10 x 10 x 72"		7.72	7.32	6.79	6.55	6.16	15 / 240	45 lbs.
■S-19781	10 x 10 x 72 - 132"	TELESCOPIC	20.03	18.35	16.78	15.63	14.91	15 / 240	93 lbs.
S-15031	11 x 6 x 4"		.87	.77	.69	.65	.61	25 / 1000	8 lbs.
S-16715	11 x 6 x 6"		.93	.84	.72	.66	.64	25 / 900	10 lbs.
S-23953	11 x 7 x 4"	32 ECT LIGHTWEIGHT	.77	.68	.64	.58	.55	25 / 1200	8 lbs.
S-13289	11 x 7 x 7"		.99	.92	.82	.75	.71	25 / 900	12 lbs.
S-21594	11 x 8 x 3"		.93	.83	.72	.66	.65	25 / 1000	10 lbs.
S-13290	11 x 8 x 4"		.94	.84	.75	.69	.66	25 / 900	11 lbs.
S-16716	11 x 8 x 5"		.96	.87	.77	.71	.66	25 / 900	12 lbs.
S-4607	11 x 8 x 6"		.98	.90	.80	.72	.69	25 / 900	13 lbs.
S-25347	11 x 8 x 7"	32 ECT LIGHTWEIGHT NEW	.90	.79	.70	.66	.65	25 / 900	11 lbs.
S-14268	11 x 8 x 8"		1.06	.99	.93	.87	.77	25 / 750	14 lbs.
S-23307	11 x 8 x 10"		1.19	1.11	.98	.93	.83	25 / 600	17 lbs.
S-24728	11 x 9 x 3"	32 ECT LIGHTWEIGHT	.87	.81	.72	.66	.64	25 / 900	10 lbs.
S-16717	11 x 9 x 6"		1.08	1.04	.94	.90	.84	25 / 750	14 lbs.
S-23965	11 x 9 x 8"	32 ECT LIGHTWEIGHT	1.12	.98	.86	.79	.76	25 / 900	13 lbs.
S-11371	11 x 9 x 9"		1.36	1.18	.99	.94	.92	25 / 500	17 lbs.
S-16718	11 x 11 x 3"		1.23	1.06	.93	.90	.82	25 / 500	15 lbs.
S-21003	11 x 11 x 4"		1.24	1.08	.94	.92	.83	25 / 500	16 lbs.
S-13291	11 x 11 x 5"		1.25	1.11	.96	.93	.84	25 / 500	16 lbs.
S-16719	11 x 11 x 6"		1.32	1.18	.99	.96	.90	25 / 500	18 lbs.
S-4608	11 x 11 x 7"		1.38	1.24	1.04	.99	.94	25 / 500	19 lbs.
S-19859	11 x 11 x 8"		1.40	1.28	1.11	1.04	.99	25 / 500	20 lbs.
S-4852	11 x 11 x 9"		1.44	1.34	1.17	1.06	1.04	25 / 500	21 lbs.
S-19098	11 x 11 x 10"		1.52	1.38	1.25	1.12	1.08	25 / 500	22 lbs.
S-4316	11 x 11 x 11"	200 LB. TEST	1.58	1.40	1.36	1.17	1.12	25 / 500	22 lbs.
S-20462	11 x 11 x 11"	32 ECT LIGHTWEIGHT	1.32	1.17	1.12	.98	.94	25 / 600	19 lbs.
S-21595	11 x 11 x 13"		1.71	1.52	1.47	1.28	1.23	25 / 500	25 lbs.
S-4559	11 1/4 x 8 3/4 x 2 3/4"		.64	.64	.64	.64	.64	25 / 500	10 lbs.
S-4954	11 1/4 x 8 3/4 x 4"		.99	.92	.82	.77	.69	25 / 500	12 lbs.
S-16455	11 1/4 x 8 3/4 x 4"	WHITE	1.15	1.04	1.01	.98	.90	25 / 500	12 lbs.
S-18385	11 1/4 x 8 3/4 x 5"		1.02	.94	.87	.82	.72	25 / 500	13 lbs.
S-4609	11 1/4 x 8 3/4 x 6"		1.04	.96	.92	.84	.77	25 / 500	14 lbs.
S-4420	11 1/4 x 8 3/4 x 6"	6,4,2" 200 LB. TEST	.77	.77	.77	.77	.77	25 / 500	14 lbs.
S-21599	11 1/4 x 8 3/4 x 6"	6,4,2" 32 ECT	.63	.63	.63	.63	.63	25 / 900	12 lbs.
S-14226*	11 1/4 x 8 3/4 x 6"	275 LB. TEST	1.44	1.36	1.23	1.12	1.06	25 / 750	21 lbs.
S-18181 •	11 1/4 x 8 3/4 x 6"	275 LB. TEST DW	2.04	1.90	1.74	1.64	1.58	15 / 450	13 lbs.
S-12591	11 1/4 x 8 3/4 x 8"		1.11	1.02	.96	.93	.84	25 / 500	16 lbs.
S-18948	11 1/4 x 8 3/4 x 8"	WHITE	1.39	1.24	1.15	1.08	1.04	25 / 500	16 lbs.
S-4610	11 1/4 x 8 3/4 x 9 1/2"		1.17	1.04	.99	.96	.90	25 / 500	17 lbs.
S-4109	11 1/4 x 8 3/4 x 10"	5 REAM BOX	1.38	1.18	1.04	.99	.94	25 / 500	18 lbs.
S-16720*	11 1/4 x 8 3/4 x 10"	275 LB. TEST	1.79	1.65	1.46	1.40	1.34	25 / 500	25 lbs.
S-4560	11 1/4 x 8 3/4 x 12"	200 LB. TEST	1.02	1.02	1.02	1.02	1.02	25 / 500	19 lbs.
S-19860	11 1/4 x 8 3/4 x 12"	32 ECT LIGHTWEIGHT	.82	.82	.82	.82	.82	25 / 600	16 lbs.
S-279	11 1/4 x 8 3/4 x 12"	12,10,8"	.99	.99	.99	.99	.99	25 / 500	19 lbs.
S-4783*	11 1/4 x 8 3/4 x 12"	275 LB. TEST	1.96	1.84	1.60	1.50	1.42	25 / 500	32 lbs.
S-20476	11 1/4 x 8 3/4 x 14"		1.49	1.39	1.29	1.24	1.14	25 / 500	22 lbs.
S-4111	11 1/4 x 8 3/4 x 4 3/4"	2 1/2 REAM BOX	1.01	.90	.84	.80	.72	25 / 500	13 lbs.
S-4112	11 1/4 x 8 3/4 x 8 3/4"	4 1/2 REAM BOX	1.12	1.04	.98	.94	.84	25 / 500	17 lbs.
S-16721	12 x 3 x 3"		.69	.64	.60	.56	.54	25 / 1800	5 lbs.
S-4116	12 x 4 x 4"	200 LB. TEST	.58	.58	.58	.58	.58	25 / 1500	7 lbs.
S-22606	12 x 4 x 4"	32 ECT LIGHTWEIGHT	.48	.48	.48	.48	.48	25 / 1500	6 lbs.
S-18237	12 x 4 x 48 - 90"	TELESCOPIC	8.84	8.55	8.02	7.45	6.88	25 / 250	80 lbs.
S-19099	12 x 5 x 4"		.90	.77	.69	.66	.62	25 / 1500	8 lbs.
S-16722	12 x 5 x 5"		.92	.80	.71	.66	.62	25 / 1000	8 lbs.
S-11372	12 x 6 x 2"		.86	.75	.66	.65	.60	25 / 1500	7 lbs.
S-16723	12 x 6 x 3"		.87	.77	.69	.66	.61	25 / 1250	8 lbs.
S-4127	12 x 6 x 4"	200 LB. TEST	.59	.59	.59	.59	.59	25 / 1000	9 lbs.
S-19861	12 x 6 x 4"	32 ECT LIGHTWEIGHT	.50	.50	.50	.50	.50	25 / 1200	8 lbs.
S-15032	12 x 6 x 5"		.93	.82	.72	.69	.64	25 / 1000	10 lbs.
S-4128	12 x 6 x 6"	200 LB. TEST	.61	.61	.61	.61	.61	25 / 900	11 lbs.
S-19063	12 x 6 x 6"	32 ECT LIGHTWEIGHT	.52	.52	.52	.52	.52	25 / 1200	9 lbs.
S-4709	12 x 6 x 6"	6,4,2"	1.24	1.04	.98	.94	.92	25 / 900	11 lbs.



S-14267  
10 x 10 x 30"

**LARGER QUANTITIES  
CALL FOR QUOTE**



**PRINTERS BOXES**

**BEST SELLERS**

- S-4559 11 1/4 x 8 3/4 x 2 3/4"
- S-4560 11 1/4 x 8 3/4 x 12"
- S-4173 17 1/4 x 11 1/4 x 6"
- S-4175 17 1/4 x 11 1/4 x 8"

**LARGEST STOCK  
BOX INVENTORY IN  
NORTH AMERICA**

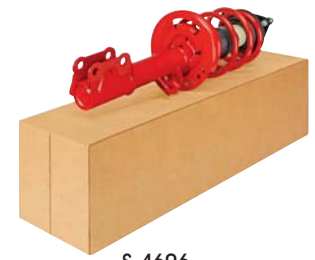

S-4606  
10 x 10 x 48"

- SOLD IN BUNDLE QUANTITIES
- \* 275 LB. TEST
- 275 LB. TEST DOUBLE WALL (DW)
- SHIPS VIA MOTOR FREIGHT

**MORE BOXES**  
→



S-4125  
12 x 12 x 12"  
CUBE BOX

\$1.03 per box any bundle qty.

**ORDER BY 6 PM FOR  
SAME DAY SHIPPING**



S-4122  
12 x 12 x 6"

\$.93 per box any bundle qty.

**LARGER QUANTITIES  
CALL FOR QUOTE**



S-4616  
12 x 12 x 14"

SOLD IN BUNDLE QUANTITIES

\* 275 LB. TEST

• 275 LB. TEST DOUBLE WALL (DW)

MODEL NO.	INSIDE DIM. L x W x H	VARIABLE DEPTH	PRICE PER BOX					BUNDLE/BALE QTY.	WT./BNDL.
			25	100	250	500	1,000+		
S-4784*	12 x 6 x 6"	275 LB. TEST	\$1.34	\$1.18	\$1.06	\$1.02	\$.96	25 / 500	19 lbs.
S-4710	12 x 6 x 8"		1.04	.96	.84	.77	.72	25 / 500	13 lbs.
S-12592	12 x 6 x 12"		1.36	1.23	1.05	1.02	.96	25 / 500	17 lbs.
S-22180	12 x 7 x 4"		.94	.83	.73	.69	.65	25 / 1000	10 lbs.
S-13293	12 x 7 x 5"		.96	.84	.75	.71	.66	25 / 900	11 lbs.
S-18386	12 x 7 x 7"		1.06	.99	.90	.80	.75	25 / 900	13 lbs.
S-23954	12 x 8 x 2"	32 ECT LIGHTWEIGHT	.82	.75	.64	.60	.56	25 / 1200	8 lbs.
S-16724	12 x 8 x 3"		.98	.90	.79	.71	.66	25 / 1000	11 lbs.
S-4117	12 x 8 x 4"	200 LB. TEST	.99	.92	.80	.72	.69	25 / 900	12 lbs.
S-21016	12 x 8 x 4"	32 ECT LIGHTWEIGHT	.84	.77	.66	.61	.58	25 / 1200	10 lbs.
S-4711	12 x 8 x 5"		1.04	.94	.82	.75	.71	25 / 900	13 lbs.
S-4121	12 x 8 x 6"	200 LB. TEST	.68	.68	.68	.68	.68	25 / 500	13 lbs.
S-19064	12 x 8 x 6"	32 ECT LIGHTWEIGHT	.59	.59	.59	.59	.59	25 / 900	12 lbs.
S-4979	12 x 8 x 7"		1.12	1.04	.94	.84	.80	25 / 900	15 lbs.
S-4129	12 x 8 x 8"	200 LB. TEST	.77	.77	.77	.77	.77	25 / 500	15 lbs.
S-19065	12 x 8 x 8"	32 ECT LIGHTWEIGHT	.62	.62	.62	.62	.62	25 / 900	13 lbs.
S-20486	12 x 8 x 8"	WHITE	1.31	1.18	1.08	1.04	.98	25 / 900	15 lbs.
S-22633	12 x 8 x 10"		1.28	1.19	1.01	.94	.90	25 / 500	17 lbs.
S-18387	12 x 8 x 12"		1.42	1.32	1.11	1.04	1.01	25 / 500	19 lbs.
S-4118	12 x 9 x 2"		.76	.76	.76	.76	.76	25 / 900	12 lbs.
S-4312	12 x 9 x 3"	200 LB. TEST	.77	.77	.77	.77	.77	25 / 750	12 lbs.
S-23289	12 x 9 x 3"	32 ECT LIGHTWEIGHT	.62	.62	.62	.62	.62	25 / 900	10 lbs.
S-4521	12 x 9 x 4"	200 LB. TEST	.79	.79	.79	.79	.79	25 / 750	13 lbs.
S-19066	12 x 9 x 4"	32 ECT LIGHTWEIGHT	.63	.63	.63	.63	.63	25 / 900	12 lbs.
S-14262	12 x 9 x 4"	WHITE	1.36	1.23	1.12	1.06	.99	25 / 750	13 lbs.
S-4487	12 x 9 x 5"	200 LB. TEST	1.17	1.04	.98	.94	.90	25 / 750	14 lbs.
S-22181	12 x 9 x 5"	32 ECT LIGHTWEIGHT	.98	.87	.83	.79	.73	25 / 900	12 lbs.
S-4406	12 x 9 x 6"	200 LB. TEST	.87	.87	.87	.87	.87	25 / 750	15 lbs.
S-18339	12 x 9 x 6"	32 ECT LIGHTWEIGHT	.71	.71	.71	.71	.71	25 / 900	12 lbs.
S-4421	12 x 9 x 6"	6,4,2"	1.33	1.11	1.05	1.01	.99	25 / 750	15 lbs.
S-19771 •	12 x 9 x 6"	275 LB. TEST DW	2.16	2.01	1.88	1.75	1.65	15 / 450	15 lbs.
S-4488	12 x 9 x 7"	200 LB. TEST	1.36	1.18	1.02	.96	.94	25 / 750	16 lbs.
S-22634	12 x 9 x 7"	32 ECT LIGHTWEIGHT	1.14	.99	.85	.82	.79	25 / 900	13 lbs.
S-4853	12 x 9 x 8"		1.38	1.23	1.04	.98	.96	25 / 500	17 lbs.
S-4335	12 x 9 x 9"	200 LB. TEST	.93	.93	.93	.93	.93	25 / 500	18 lbs.
S-19852	12 x 9 x 9"	32 ECT LIGHTWEIGHT	.78	.78	.78	.78	.78	25 / 600	15 lbs.
S-21534 •	12 x 9 x 9"	275 LB. TEST DW	2.48	2.32	2.11	2.01	1.91	15 / 300	18 lbs.
S-4612	12 x 9 x 10"		1.42	1.29	1.06	1.02	.99	25 / 500	20 lbs.
S-4884	12 x 9 x 12"	200 LB. TEST	1.49	1.38	1.12	1.05	1.04	25 / 500	21 lbs.
S-21017	12 x 9 x 12"	32 ECT LIGHTWEIGHT	1.24	1.14	.94	.90	.86	25 / 600	18 lbs.
S-4980	12 x 10 x 2"		1.18	1.05	.94	.92	.87	25 / 900	13 lbs.
S-4409	12 x 10 x 3"		1.19	1.06	.96	.93	.90	25 / 500	14 lbs.
S-4119	12 x 10 x 4"	200 LB. TEST	.87	.87	.87	.87	.87	25 / 500	15 lbs.
S-19853	12 x 10 x 4"	32 ECT LIGHTWEIGHT	.73	.73	.73	.73	.73	25 / 900	12 lbs.
S-4522	12 x 10 x 5"	200 LB. TEST	1.24	1.12	.99	.96	.92	25 / 500	16 lbs.
S-22635	12 x 10 x 5"	32 ECT LIGHTWEIGHT	1.04	.94	.84	.82	.79	25 / 900	13 lbs.
S-4130	12 x 10 x 6"	200 LB. TEST	.89	.89	.89	.89	.89	25 / 500	17 lbs.
S-18340	12 x 10 x 6"	32 ECT LIGHTWEIGHT	.76	.76	.76	.76	.76	25 / 900	14 lbs.
S-15033	12 x 10 x 6"	WHITE	1.58	1.40	1.22	1.12	1.06	25 / 500	17 lbs.
S-14227*	12 x 10 x 6"	275 LB. TEST	1.65	1.57	1.42	1.38	1.34	25 / 500	24 lbs.
S-4885	12 x 10 x 7"		1.36	1.23	1.04	.99	.96	25 / 500	18 lbs.
S-4120	12 x 10 x 8"	200 LB. TEST	.91	.91	.91	.91	.91	25 / 500	19 lbs.
S-18341	12 x 10 x 8"	32 ECT LIGHTWEIGHT	.78	.78	.78	.78	.78	25 / 600	15 lbs.
S-15034	12 x 10 x 8"	8,6,4"	1.49	1.38	1.22	1.06	1.04	25 / 500	19 lbs.
S-19777	12 x 10 x 8"	WHITE	1.70	1.50	1.32	1.19	1.15	25 / 500	19 lbs.
S-15035*	12 x 10 x 8"	275 LB. TEST	1.70	1.60	1.44	1.40	1.38	25 / 500	27 lbs.
S-4336	12 x 10 x 9"		1.42	1.29	1.06	1.02	.98	25 / 500	20 lbs.
S-4123	12 x 10 x 10"	200 LB. TEST	.94	.94	.94	.94	.94	25 / 500	21 lbs.
S-19067	12 x 10 x 10"	32 ECT LIGHTWEIGHT	.79	.79	.79	.79	.79	25 / 600	18 lbs.
S-18182 •	12 x 10 x 10"	275 LB. TEST DW	2.85	2.67	2.44	2.32	2.18	15 / 300	19 lbs.
S-12593	12 x 10 x 12"		1.49	1.38	1.12	1.05	1.04	25 / 500	22 lbs.
S-21564	12 x 10 x 14"		1.62	1.49	1.23	1.15	1.12	25 / 500	25 lbs.
S-22636	12 x 11 x 11"		1.70	1.54	1.36	1.19	1.14	25 / 600	24 lbs.
S-4561	12 x 12 x 2"		1.24	1.11	.99	.94	.92	25 / 500	16 lbs.



MODEL NO.	INSIDE DIM. L x W x H /	VARIABLE DEPTH	PRICE PER BOX					BUNDLE/BALE QTY.	WT./BNDL.
			25	100	250	500	1,000+		
S-4460	12 x 12 x 3"	200 LB. TEST	\$.88	\$.88	\$.88	\$.88	\$.88	25 / 500	17 lbs.
S-23290	12 x 12 x 3"	32 ECT LIGHTWEIGHT	.75	.75	.75	.75	.75	25 / 600	14 lbs.
S-4215	12 x 12 x 4"	200 LB. TEST	.89	.89	.89	.89	.89	25 / 500	18 lbs.
S-19068	12 x 12 x 4"	32 ECT LIGHTWEIGHT	.76	.76	.76	.76	.76	25 / 600	15 lbs.
S-19778	12 x 12 x 4"	WHITE	1.58	1.42	1.22	1.14	1.06	25 / 500	18 lbs.
S-23959*	12 x 12 x 4"	275 LB. TEST DW	2.53	2.36	2.20	2.05	1.97	15 / 300	18 lbs.
S-4489	12 x 12 x 5"	200 LB. TEST	1.29	1.17	1.04	.99	.96	25 / 500	19 lbs.
S-23301	12 x 12 x 5"	32 ECT LIGHTWEIGHT	1.08	.98	.86	.84	.82	25 / 600	16 lbs.
S-4122	12 x 12 x 6"	200 LB. TEST	.93	.93	.93	.93	.93	25 / 500	20 lbs.
S-18342	12 x 12 x 6"	32 ECT LIGHTWEIGHT	.78	.78	.78	.78	.78	25 / 600	17 lbs.
S-4341	12 x 12 x 6"	6,4,2"	1.52	1.40	1.23	1.08	1.05	25 / 500	20 lbs.
S-4932	12 x 12 x 6"	WHITE	1.64	1.49	1.25	1.18	1.11	25 / 500	20 lbs.
S-4770*	12 x 12 x 6"	275 LB. TEST	1.71	1.61	1.50	1.42	1.40	25 / 500	27 lbs.
S-14228*	12 x 12 x 6"	275 LB. TEST DW	2.69	2.51	2.33	2.17	2.07	15 / 300	19 lbs.
S-4613	12 x 12 x 7"	200 LB. TEST	1.42	1.36	1.12	1.06	1.04	25 / 500	21 lbs.
S-22637	12 x 12 x 7"	32 ECT LIGHTWEIGHT	1.19	1.14	.94	.90	.86	25 / 600	18 lbs.
S-4124	12 x 12 x 8"	200 LB. TEST	1.00	1.00	1.00	1.00	1.00	25 / 500	23 lbs.
S-18343	12 x 12 x 8"	32 ECT LIGHTWEIGHT	.87	.87	.87	.87	.87	25 / 600	18 lbs.
S-13294	12 x 12 x 8"	WHITE	1.84	1.65	1.42	1.38	1.29	25 / 500	23 lbs.
S-12594*	12 x 12 x 8"	275 LB. TEST DW	2.75	2.60	2.38	2.29	2.17	15 / 300	21 lbs.
S-4337	12 x 12 x 9"	200 LB. TEST	1.65	1.49	1.29	1.23	1.17	25 / 500	23 lbs.
S-21565	12 x 12 x 9"	32 ECT LIGHTWEIGHT	1.40	1.24	1.06	1.04	.99	25 / 600	20 lbs.
S-4126	12 x 12 x 10"	200 LB. TEST	1.12	1.12	1.12	1.12	1.12	25 / 500	25 lbs.
S-19069	12 x 12 x 10"	32 ECT LIGHTWEIGHT	.94	.94	.94	.94	.94	25 / 600	21 lbs.
S-16456	12 x 12 x 10"	WHITE	1.96	1.84	1.53	1.44	1.40	25 / 500	25 lbs.
S-15036*	12 x 12 x 10"	275 LB. TEST DW	2.95	2.73	2.51	2.38	2.26	15 / 300	23 lbs.
S-4981	12 x 12 x 11"		1.84	1.69	1.42	1.29	1.23	25 / 500	26 lbs.
S-4125	12 x 12 x 12"	200 LB. BEST SELLER	1.03	1.03	1.03	1.03	1.03	25 / 500	27 lbs.
S-18344	12 x 12 x 12"	32 ECT LIGHTWEIGHT	.89	.89	.89	.89	.89	25 / 600	22 lbs.
S-536	12 x 12 x 12"	12,10,8,6"	1.42	1.42	1.42	1.42	1.42	25 / 500	27 lbs.
S-4431	12 x 12 x 12"	WHITE	1.99	1.87	1.56	1.47	1.43	25 / 500	27 lbs.
S-4475*	12 x 12 x 12"	275 LB. TEST	2.10	1.98	1.82	1.71	1.66	25 / 500	38 lbs.
S-4712*	12 x 12 x 12"	275 LB. TEST DW	2.20	2.20	2.20	2.20	2.20	15 / 300	25 lbs.
S-18916	12 x 12 x 12"	500 LB. TEST DW	7.28	6.82	6.41	5.98	5.64	15 / 300	40 lbs.
S-20485	12 x 12 x 13"		1.98	1.79	1.63	1.60	1.46	25 / 300	28 lbs.
S-4616	12 x 12 x 14"		2.07	1.85	1.70	1.64	1.50	25 / 250	28 lbs.
S-4523	12 x 12 x 15"		2.10	1.88	1.71	1.65	1.52	25 / 250	29 lbs.
S-4524	12 x 12 x 16"		2.16	1.97	1.81	1.71	1.58	25 / 250	30 lbs.
S-18919*	12 x 12 x 16"	275 LB. TEST DW	3.75	3.52	3.20	3.03	2.92	15 / 150	30 lbs.
S-14269	12 x 12 x 18"		2.17	1.98	1.84	1.73	1.60	25 / 250	32 lbs.
S-4490	12 x 12 x 18"	18,16,14,12,10"	2.20	2.02	1.86	1.75	1.61	25 / 250	32 lbs.
S-16516*	12 x 12 x 18"	275 LB. TEST DW	3.95	3.69	3.35	3.20	3.03	15 / 150	31 lbs.
S-4467	12 x 12 x 20"		2.18	2.04	1.92	1.79	1.64	25 / 250	35 lbs.
S-4455	12 x 12 x 24"	2 CU. FT.	2.64	2.43	2.29	2.11	1.94	25 / 250	38 lbs.
S-4617	12 x 12 x 30"		3.14	2.91	2.73	2.59	2.33	15 / 240	27 lbs.
S-4491	12 x 12 x 36"	3 CU. FT.	3.66	3.35	3.14	3.00	2.73	15 / 240	31 lbs.
S-4618	12 x 12 x 40"		4.32	3.99	3.72	3.54	3.20	15 / 240	33 lbs.
S-4525	12 x 12 x 48"		3.49	3.49	3.49	3.49	3.49	15 / 240	37 lbs.
S-13295*	12 x 12 x 48"	275 LB. TEST DW	9.23	8.55	7.92	7.48	7.13	10 / 180	40 lbs.
S-4983	12 x 12 x 48 - 90"	TELESCOPIC	12.45	11.77	11.15	10.36	9.59	15 / 240	74 lbs.
S-4713	12 x 12 x 52"		5.24	4.92	4.68	4.36	4.01	15 / 240	40 lbs.
S-4692	12 x 12 x 60"		7.10	6.54	6.16	5.89	5.46	10 / 240	32 lbs.
S-4693	12 x 12 x 72"		7.86	7.31	6.97	6.77	6.07	10 / 240	37 lbs.
S-18238	12 x 12 x 72 - 132"	TELESCOPIC	24.00	22.00	20.00	19.00	18.00	15 / 240	113 lbs.
S-4935*	12 1/8 x 12 1/8 x 13 1/2"	275 LB. TEST DW	3.30	3.00	2.82	2.67	2.51	15 / 150	27 lbs.
S-19833	12 1/4 x 9 1/4 x 6"		1.28	1.17	.99	.94	.93	25 / 900	16 lbs.
S-4955	12 1/4 x 9 1/4 x 9"		1.40	1.25	1.04	.99	.98	25 / 500	18 lbs.
S-14270	12 1/4 x 9 1/4 x 12"		1.61	1.44	1.24	1.12	1.11	25 / 500	21 lbs.
S-558	12 1/4 x 9 1/4 x 12"	12,10,8,6"	1.79	1.64	1.46	1.37	1.34	25 / 500	21 lbs.
S-4754	12 1/2 x 12 1/2 x 6"	6,4,2"	1.81	1.69	1.49	1.40	1.38	25 / 500	21 lbs.
S-4562	12 1/2 x 12 1/2 x 12"	12,10,8,6"	2.10	1.88	1.71	1.65	1.52	25 / 250	28 lbs.
S-4936*	12 1/2 x 12 1/2 x 15"	275 LB. TEST DW	3.63	3.34	3.13	2.96	2.76	15 / 150	30 lbs.
S-4615	12 3/4 x 12 3/4 x 13 1/2"	8 PACK - 6 x 6 x 6"	2.11	1.92	1.73	1.71	1.58	25 / 250	30 lbs.
S-19087	13 x 3 x 3"		.75	.66	.62	.60	.56	25 / 1800	5 lbs.



S-4455  
12 x 12 x 24"  
TALL BOX

**ORDERS SHIP FROM  
NEAREST ULINE  
LOCATION**



S-4521  
12 x 9 x 4"

\$.79 per box any bundle qty.

**SEE RED AND SAVE  
ON POPULAR SIZES !**



S-4406  
12 x 9 x 6"

SOLD IN BUNDLE QUANTITIES  
\* 275 LB. TEST  
• 275 LB. TEST DOUBLE WALL (DW)  
■ SHIPS VIA MOTOR FREIGHT



S-18920  
14 x 10 x 10"  
275 LB. TEST DW

**OVER 1,700 BOX SIZES  
ALWAYS IN STOCK**

**CORRUGATED TRAYS**



Economical solution to transport light loads.

- Hold plants, cans, bottles and other miscellaneous items securely.
- Ship flat, easy to assemble.

200 LB. TEST

MODEL NO.	INSIDE DIM. L x W x H	PRICE EACH
S-13340	15 x 12 x 2"	\$.80
S-18333	15 x 12 x 4"	1.32



S-4407  
14 x 12 x 12"

SOLD IN BUNDLE QUANTITIES

- \* 275 LB. TEST
  - 275 LB. TEST DOUBLE WALL (DW)
- FOL = FULL OVERLAP

MODEL NO.	INSIDE DIM. L x W x H	VARIABLE DEPTH	PRICE PER BOX					BUNDLE/BALE QTY.	WT./BNDL.
			25	100	250	500	1,000+		
S-17999	13 x 3 x 30"	FOL, RACQUET BOX	\$3.10	\$2.76	\$2.67	\$2.59	\$2.44	25 / 375	26 lbs.
S-24051	13 x 5 x 5"	32 ECT LIGHTWEIGHT	.82	.71	.66	.62	.60	25 / 1000	8 lbs.
S-22645	13 x 6 x 9"		1.11	1.02	.93	.83	.79	25 / 750	14 lbs.
S-4924	13 x 7 x 7"		1.06	.99	.92	.82	.77	25 / 500	13 lbs.
S-22168	13 x 8 x 6"		1.14	1.02	.93	.85	.82	25 / 900	14 lbs.
S-19088	13 x 8 x 8"		1.28	1.11	.98	.94	.90	25 / 500	16 lbs.
S-18391	13 x 9 x 4"		1.32	1.17	1.01	.96	.93	25 / 900	14 lbs.
S-23955	13 x 9 x 5"	32 ECT LIGHTWEIGHT	1.08	.99	.92	.85	.79	25 / 900	12 lbs.
S-4817	13 x 9 x 6"		1.49	1.38	1.17	1.11	1.05	25 / 500	16 lbs.
S-14271	13 x 9 x 7"		1.50	1.39	1.18	1.12	1.06	25 / 500	17 lbs.
S-21053	13 x 9 x 8"		1.53	1.40	1.22	1.15	1.08	25 / 500	18 lbs.
S-11373	13 x 9 x 9"		1.57	1.42	1.24	1.17	1.11	25 / 500	18 lbs.
S-4837	13 x 9 x 11"		1.60	1.42	1.25	1.18	1.12	25 / 500	19 lbs.
S-4715	13 x 10 x 2"		1.18	1.05	.98	.94	.92	25 / 500	14 lbs.
S-24736	13 x 10 x 3"	32 ECT LIGHTWEIGHT	1.04	.94	.84	.82	.79	25 / 900	12 lbs.
S-4716	13 x 10 x 4"	200 LB. TEST	.89	.89	.89	.89	.89	25 / 500	16 lbs.
S-19834	13 x 10 x 4"	32 ECT LIGHTWEIGHT	.76	.76	.76	.76	.76	25 / 900	13 lbs.
S-4854	13 x 10 x 5"		1.34	1.18	1.04	.99	.96	25 / 500	17 lbs.
S-13296	13 x 10 x 6"	200 LB. TEST	1.38	1.24	1.08	1.04	1.02	25 / 500	17 lbs.
S-23310	13 x 10 x 6"	32 ECT LIGHTWEIGHT	1.12	1.01	.87	.84	.82	25 / 600	14 lbs.
S-4982	13 x 10 x 7"		1.40	1.25	1.12	1.06	1.04	25 / 500	18 lbs.
S-4838	13 x 10 x 8"		1.49	1.38	1.18	1.11	1.06	25 / 500	20 lbs.
S-22646	13 x 10 x 9"		1.59	1.44	1.27	1.18	1.14	25 / 600	21 lbs.
S-4785	13 x 10 x 10"	200 LB. TEST	1.65	1.50	1.36	1.25	1.18	25 / 500	22 lbs.
S-21571	13 x 10 x 10"	32 ECT LIGHTWEIGHT	1.40	1.25	1.14	1.05	1.01	25 / 600	18 lbs.
S-22169	13 x 10 x 12"		1.79	1.60	1.44	1.38	1.29	25 / 500	24 lbs.
S-19835	13 x 10 x 13"		1.85	1.65	1.52	1.42	1.36	25 / 500	25 lbs.
S-21064	13 x 10 x 15"		2.01	1.81	1.64	1.54	1.47	25 / 250	27 lbs.
S-21572	13 x 11 x 2"		1.32	1.18	1.02	.98	.92	25 / 900	15 lbs.
S-4131	13 x 11 x 5"		1.38	1.23	1.05	1.02	.96	25 / 500	18 lbs.
S-24052	13 x 11 x 6"	32 ECT LIGHTWEIGHT	1.18	1.07	.93	.86	.83	25 / 600	16 lbs.
S-4717	13 x 11 x 7"		1.42	1.34	1.08	1.04	.99	25 / 500	20 lbs.
S-23311	13 x 11 x 8"		1.52	1.42	1.19	1.12	1.07	25 / 600	21 lbs.
S-14272	13 x 11 x 9"		1.61	1.49	1.24	1.17	1.11	25 / 500	22 lbs.
S-4886	13 x 13 x 2"		1.42	1.31	1.11	1.04	1.02	25 / 500	18 lbs.
S-19090	13 x 13 x 3"		1.44	1.32	1.12	1.05	1.04	25 / 500	20 lbs.
S-4526	13 x 13 x 4"		.99	.99	.99	.99	.99	25 / 500	20 lbs.
S-4887	13 x 13 x 5"		1.50	1.38	1.18	1.11	1.05	25 / 500	21 lbs.
S-13297	13 x 13 x 6"		1.61	1.44	1.29	1.24	1.12	25 / 500	22 lbs.
S-4563	13 x 13 x 7"		1.70	1.52	1.40	1.36	1.24	25 / 500	24 lbs.
S-4984	13 x 13 x 8"		1.74	1.60	1.44	1.40	1.34	25 / 500	25 lbs.
S-19089	13 x 13 x 9"		1.81	1.64	1.50	1.44	1.38	25 / 500	27 lbs.
S-4694	13 x 13 x 10"	200 LB. TEST	1.88	1.70	1.57	1.50	1.40	25 / 500	28 lbs.
S-23291	13 x 13 x 10"	32 ECT LIGHTWEIGHT	1.59	1.42	1.31	1.26	1.18	25 / 600	23 lbs.
S-19836	13 x 13 x 12"		1.95	1.75	1.62	1.57	1.46	25 / 500	30 lbs.
S-4317	13 x 13 x 13"	200 LB. FITS 3 1/2 GAL.	1.41	1.41	1.41	1.41	1.41	25 / 500	31 lbs.
S-19070	13 x 13 x 13"	32 ECT LIGHTWEIGHT	1.18	1.18	1.18	1.18	1.18	25 / 600	27 lbs.
S-4444	13 x 13 x 13"	13,11,9,7"	2.33	1.96	1.79	1.73	1.69	25 / 500	31 lbs.
S-15037*	13 x 13 x 13"	275 LB. TEST DW	3.58	3.32	3.11	2.95	2.75	15 / 180	30 lbs.
S-11374	13 x 13 x 15"		2.43	2.17	1.97	1.81	1.73	25 / 250	32 lbs.
S-18392	13 x 13 x 17"		2.60	2.33	2.08	1.95	1.88	25 / 250	36 lbs.
S-4956	13 1/4 x 10 1/4 x 9"		1.61	1.44	1.29	1.23	1.17	25 / 500	20 lbs.
S-4895	13 1/4 x 10 1/4 x 12"	12,10,8,6"	1.96	1.74	1.61	1.57	1.44	25 / 300	24 lbs.
S-4388	13 1/2 x 13 1/2 x 7 1/2"		1.79	1.61	1.42	1.36	1.24	25 / 500	26 lbs.
S-13298	14 x 4 x 4"		.93	.82	.75	.69	.65	25 / 1250	7 lbs.
S-17998	14 x 4 x 42"	FOL, RIFLE BOX	4.72	4.37	4.15	3.89	3.67	15 / 240	24 lbs.
S-19782	14 x 4 x 52"	FOL, RIFLE BOX	5.66	5.20	4.97	4.66	4.39	15 / 240	30 lbs.
S-14223*	14 x 4 x 68"	FOL, SNOWBOARD BOX	11.37	10.67	9.96	9.00	8.66	10 / 240	37 lbs.
S-19085	14 x 6 x 2"		.98	.86	.79	.75	.66	25 / 1200	8 lbs.
S-4527	14 x 6 x 4"		.68	.68	.68	.68	.68	25 / 750	10 lbs.
S-4138	14 x 6 x 6"	200 LB. TEST	.68	.68	.68	.68	.68	25 / 500	11 lbs.
S-22607	14 x 6 x 6"	32 ECT LIGHTWEIGHT	.58	.58	.58	.58	.58	25 / 900	10 lbs.
S-23292	14 x 6 x 8"	32 ECT LIGHTWEIGHT	.90	.80	.72	.71	.69	25 / 900	11 lbs.
S-24053	14 x 7 x 5"	32 ECT LIGHTWEIGHT	.85	.76	.71	.68	.66	25 / 1200	10 lbs.



MODEL NO.	INSIDE DIM. L x W x H /	VARIABLE DEPTH	PRICE PER BOX					BUNDLE/BALE QTY.	WT./BNDL.
			25	100	250	500	1,000+		
S-4529	14 x 7 x 7"		\$1.18	\$1.05	\$.96	\$.94	\$.92	25 / 500	14 lbs.
S-16737	14 x 8 x 4"		1.04	.96	.87	.82	.75	25 / 900	13 lbs.
S-21004	14 x 8 x 5"		1.12	1.02	.92	.87	.85	25 / 900	14 lbs.
S-4137	14 x 8 x 6"	200 LB. TEST	1.17	1.04	.94	.92	.90	25 / 500	15 lbs.
S-21005	14 x 8 x 6"	32 ECT LIGHTWEIGHT	.98	.87	.80	.77	.75	25 / 900	13 lbs.
S-4139	14 x 8 x 8"	200 LB. TEST	1.29	1.12	.99	.96	.92	25 / 500	17 lbs.
S-21006	14 x 8 x 8"	32 ECT LIGHTWEIGHT	1.08	.94	.84	.82	.77	25 / 600	14 lbs.
S-16735	14 x 9 x 6"		1.32	1.15	1.01	.98	.93	25 / 500	16 lbs.
S-4985	14 x 9 x 9"	200 LB. TEST	1.42	1.29	1.08	1.04	1.01	25 / 500	20 lbs.
S-23312	14 x 9 x 9"	32 ECT LIGHTWEIGHT	1.19	1.08	.92	.87	.85	25 / 600	16 lbs.
S-13299	14 x 10 x 2"		1.29	1.15	.99	.96	.93	25 / 900	13 lbs.
S-21007	14 x 10 x 3"		1.34	1.19	1.01	.98	.94	25 / 900	15 lbs.
S-4492	14 x 10 x 4"	200 LB. TEST	1.38	1.23	1.02	.98	.94	25 / 500	16 lbs.
S-20461	14 x 10 x 4"	32 ECT LIGHTWEIGHT	1.14	1.04	.85	.83	.80	25 / 600	13 lbs.
S-4986	14 x 10 x 5"		1.42	1.25	1.05	1.04	.96	25 / 500	17 lbs.
S-4233	14 x 10 x 6"	200 LB. TEST	.91	.91	.91	.91	.91	25 / 500	18 lbs.
S-18345	14 x 10 x 6"	32 ECT LIGHTWEIGHT	.77	.77	.77	.77	.77	25 / 600	15 lbs.
S-21065	14 x 10 x 7"		1.44	1.29	1.08	1.04	.98	25 / 500	19 lbs.
S-4143	14 x 10 x 8"	200 LB. TEST	.93	.93	.93	.93	.93	25 / 500	20 lbs.
S-19849	14 x 10 x 8"	32 ECT LIGHTWEIGHT	.78	.78	.78	.78	.78	25 / 600	17 lbs.
S-4888	14 x 10 x 9"		1.50	1.39	1.12	1.05	1.04	25 / 500	22 lbs.
S-4144	14 x 10 x 10"	200 LB. TEST	1.00	1.00	1.00	1.00	1.00	25 / 500	23 lbs.
S-18346	14 x 10 x 10"	32 ECT LIGHTWEIGHT	.87	.87	.87	.87	.87	25 / 600	18 lbs.
S-537	14 x 10 x 10"	10,8,6,4"	1.81	1.69	1.50	1.44	1.40	25 / 500	23 lbs.
S-16457	14 x 10 x 10"	WHITE	1.84	1.64	1.50	1.38	1.32	25 / 500	23 lbs.
S-18920*	14 x 10 x 10"	275 LB. TEST DW	2.60	2.40	2.29	2.14	2.04	15 / 300	22 lbs.
S-22185	14 x 10 x 11"		1.65	1.57	1.37	1.29	1.24	25 / 500	24 lbs.
S-4149	14 x 10 x 12"	200 LB. TEST	1.74	1.65	1.44	1.40	1.38	25 / 500	25 lbs.
S-21596	14 x 10 x 12"	32 ECT LIGHTWEIGHT	1.47	1.40	1.22	1.17	1.15	25 / 600	21 lbs.
S-4620	14 x 11 x 3"		1.36	1.25	1.05	1.02	.96	25 / 500	16 lbs.
S-4145	14 x 11 x 6"		1.50	1.39	1.06	1.04	.98	25 / 500	20 lbs.
S-15047	14 x 11 x 8"		1.71	1.60	1.40	1.29	1.24	25 / 500	22 lbs.
S-24054	14 x 11 x 10"		1.79	1.63	1.47	1.37	1.29	25 / 600	25 lbs.
S-16736	14 x 11 x 11"		1.81	1.65	1.49	1.40	1.34	25 / 500	26 lbs.
S-16738	14 x 12 x 3"		1.38	1.28	1.06	1.04	.98	25 / 500	18 lbs.
S-4695	14 x 12 x 4"	200 LB. TEST	1.39	1.29	1.08	1.05	.99	25 / 500	19 lbs.
S-22649	14 x 12 x 4"	32 ECT LIGHTWEIGHT	1.18	1.11	.93	.90	.85	25 / 600	16 lbs.
S-24737	14 x 12 x 5"	32 ECT LIGHTWEIGHT	1.23	1.15	.99	.94	.89	25 / 600	17 lbs.
S-4987	14 x 12 x 6"	200 LB. TEST	1.52	1.40	1.24	1.17	1.06	25 / 500	22 lbs.
S-22186	14 x 12 x 6"	32 ECT LIGHTWEIGHT	1.26	1.18	1.04	.98	.92	25 / 600	19 lbs.
S-4423	14 x 12 x 6"	6,4,2"	1.03	1.03	1.03	1.03	1.03	25 / 500	22 lbs.
S-4530	14 x 12 x 8"	200 LB. TEST	1.22	1.22	1.22	1.22	1.22	25 / 500	23 lbs.
S-19854	14 x 12 x 8"	32 ECT LIGHTWEIGHT	1.03	1.03	1.03	1.03	1.03	25 / 600	20 lbs.
S-22187	14 x 12 x 9"		1.81	1.64	1.47	1.39	1.34	25 / 500	26 lbs.
S-4141	14 x 12 x 10"	200 LB. TEST	1.85	1.70	1.52	1.42	1.38	25 / 500	27 lbs.
S-21013	14 x 12 x 10"	32 ECT LIGHTWEIGHT	1.54	1.42	1.28	1.19	1.14	25 / 600	23 lbs.
S-15048*	14 x 12 x 10"	275 LB. TEST	2.61	2.40	2.16	1.97	1.88	25 / 500	39 lbs.
S-4407	14 x 12 x 12"	200 LB. TEST	2.07	1.85	1.70	1.57	1.44	25 / 250	29 lbs.
S-21597	14 x 12 x 12"	32 ECT LIGHTWEIGHT	1.73	1.54	1.42	1.32	1.22	25 / 300	25 lbs.
S-4424	14 x 12 x 12"	12,10,8,6"	2.36	2.14	1.94	1.79	1.69	25 / 250	29 lbs.
S-23305*	14 x 12 x 12"	275 LB. TEST DW	3.42	3.14	2.94	2.76	2.61	15 / 180	28 lbs.
S-20488	14 x 12 x 14"		2.22	2.01	1.84	1.69	1.57	25 / 300	32 lbs.
S-4410	14 x 14 x 2"		1.61	1.42	1.32	1.23	1.15	25 / 500	21 lbs.
S-16739	14 x 14 x 3"		1.62	1.42	1.34	1.24	1.17	25 / 500	22 lbs.
S-4943	14 x 14 x 4"	200 LB. TEST	1.65	1.44	1.36	1.25	1.18	25 / 500	23 lbs.
S-23306	14 x 14 x 4"	32 ECT LIGHTWEIGHT	1.39	1.22	1.14	1.05	.99	25 / 600	19 lbs.
S-4621	14 x 14 x 5"		1.71	1.50	1.39	1.34	1.24	25 / 500	24 lbs.
S-4140	14 x 14 x 6"	200 LB. TEST	1.22	1.22	1.22	1.22	1.22	25 / 500	26 lbs.
S-19071	14 x 14 x 6"	32 ECT LIGHTWEIGHT	1.03	1.03	1.03	1.03	1.03	25 / 600	23 lbs.
S-4531	14 x 14 x 6"	6,5,4,3"	2.04	1.81	1.65	1.49	1.42	25 / 250	26 lbs.
S-18183*	14 x 14 x 6"	275 LB. TEST DW	3.09	2.82	2.68	2.53	2.39	15 / 180	24 lbs.
S-4889	14 x 14 x 7"		1.97	1.73	1.61	1.42	1.39	25 / 500	28 lbs.
S-4146	14 x 14 x 8"	200 LB. TEST	1.35	1.35	1.35	1.35	1.35	25 / 500	29 lbs.
S-19855	14 x 14 x 8"	32 ECT LIGHTWEIGHT	1.12	1.12	1.12	1.12	1.12	25 / 600	24 lbs.



S-4317  
13 x 13 x 13"

\$1.41 per box any bundle qty.

**ORDER BY 6 PM FOR  
SAME DAY SHIPPING**



S-4785  
13 x 10 x 10"

**SEE RED AND SAVE  
ON POPULAR SIZES !**



S-4144  
14 x 10 x 10"

\$1.00 per box any bundle qty.

SOLD IN BUNDLE QUANTITIES  
\* 275 LB. TEST  
\* 275 LB. TEST DOUBLE WALL (DW)

**MORE BOXES**  
→



**SEE RED AND SAVE  
ON POPULAR SIZES !**



S-4153  
15 x 12 x 10"  
FILE BOX

\$1.40 per box any bundle qty.

**OVER 1,700 BOX SIZES  
ALWAYS IN STOCK**



S-13305  
15 x 15 x 24"

SOLD IN BUNDLE QUANTITIES

\* 275 LB. TEST

• 275 LB. TEST DOUBLE WALL (DW)

MODEL NO.	INSIDE DIM. L x W x H	VARIABLE DEPTH	PRICE PER BOX					BUNDLE/BALE QTY.	WT./BNDL.
			25	100	250	500	1,000+		
S-18921 •	14 x 14 x 8"	275 LB. TEST DW	\$3.32	\$3.03	\$2.90	\$2.71	\$2.59	15 / 180	28 lbs.
S-4347	14 x 14 x 9"		2.14	1.94	1.73	1.64	1.49	25 / 250	29 lbs.
<b>S-4147</b>	<b>14 x 14 x 10"</b>	<b>200 LB. TEST</b>	<b>1.48</b>	<b>1.48</b>	<b>1.48</b>	<b>1.48</b>	<b>1.48</b>	<b>25 / 500</b>	<b>31 lbs.</b>
<b>S-19072</b>	<b>14 x 14 x 10"</b>	<b>32 ECT LIGHTWEIGHT</b>	<b>1.24</b>	<b>1.24</b>	<b>1.24</b>	<b>1.24</b>	<b>1.24</b>	<b>25 / 600</b>	<b>27 lbs.</b>
S-14229 •	14 x 14 x 10"	275 LB. TEST DW	3.55	3.23	3.09	2.91	2.73	15 / 180	30 lbs.
S-4148	14 x 14 x 12"	200 LB. TEST	2.43	2.17	1.97	1.81	1.69	25 / 500	34 lbs.
S-20463	14 x 14 x 12"	32 ECT LIGHTWEIGHT	2.04	1.83	1.64	1.52	1.42	25 / 600	28 lbs.
S-21535 •	14 x 14 x 12"	275 LB. TEST DW	3.86	3.52	3.32	3.13	2.95	15 / 180	33 lbs.
<b>S-4142</b>	<b>14 x 14 x 14"</b>	<b>200 LB. TEST</b>	<b>1.62</b>	<b>1.62</b>	<b>1.62</b>	<b>1.62</b>	<b>1.62</b>	<b>25 / 250</b>	<b>38 lbs.</b>
<b>S-18347</b>	<b>14 x 14 x 14"</b>	<b>32 ECT LIGHTWEIGHT</b>	<b>1.39</b>	<b>1.39</b>	<b>1.39</b>	<b>1.39</b>	<b>1.39</b>	<b>25 / 300</b>	<b>30 lbs.</b>
S-538	14 x 14 x 14"	14,12,10,8"	2.69	2.44	2.26	2.14	2.02	25 / 250	38 lbs.
S-4432	14 x 14 x 14"	WHITE	2.96	2.67	2.43	2.18	2.11	25 / 250	38 lbs.
S-4718*	14 x 14 x 14"	275 LB. TEST	3.54	3.20	2.91	2.64	2.49	25 / 250	51 lbs.
<b>S-4786 •</b>	<b>14 x 14 x 14"</b>	<b>275 LB. TEST DW</b>	<b>2.93</b>	<b>2.93</b>	<b>2.93</b>	<b>2.93</b>	<b>2.93</b>	<b>15 / 90</b>	<b>35 lbs.</b>
S-13300	14 x 14 x 16"		2.50	2.30	2.07	1.96	1.85	25 / 250	37 lbs.
S-4855	14 x 14 x 18"		2.64	2.40	2.18	2.05	1.97	25 / 250	40 lbs.
S-4622	14 x 14 x 19"	FITS 6½ GAL.	2.73	2.49	2.29	2.11	2.04	20 / 240	32 lbs.
S-14273	14 x 14 x 20"		2.80	2.54	2.38	2.17	2.10	20 / 140	34 lbs.
S-4623	14 x 14 x 24"		3.11	2.80	2.59	2.44	2.36	15 / 150	28 lbs.
S-13301	14 x 14 x 30"		3.56	3.20	2.98	2.80	2.69	20 / 140	43 lbs.
S-4532	14 x 14 x 36"		4.07	3.66	3.35	3.19	3.02	15 / 150	37 lbs.
S-11375	14 x 14 x 40"		4.36	4.00	3.71	3.54	3.36	15 / 150	40 lbs.
S-12595	14 x 14 x 40 - 74"	TELESCOPIC	10.32	9.80	9.29	8.65	8.26	15 / 120	80 lbs.
S-12596	14 x 14 x 48"		5.05	4.72	4.49	4.18	4.00	10 / 150	29 lbs.
S-11252	14½ x 8¾ x 6"	6,4,2"	1.44	1.36	1.11	1.05	1.04	25 / 500	17 lbs.
S-521	14½ x 8¾ x 12"	12,10,8,6"	1.85	1.70	1.57	1.49	1.42	25 / 500	23 lbs.
S-24070	15 x 8 x 6"		1.19	1.07	.99	.94	.92	25 / 900	16 lbs.
S-15049	15 x 8 x 8"		1.36	1.23	1.04	.99	.93	25 / 500	17 lbs.
S-18390	15 x 9 x 8"		1.60	1.44	1.25	1.18	1.11	25 / 500	19 lbs.
S-23956	15 x 10 x 2"	32 ECT LIGHTWEIGHT	1.19	1.07	.98	.89	.84	25 / 900	12 lbs.
S-16743	15 x 10 x 4"		1.39	1.24	1.04	.99	.96	25 / 500	16 lbs.
S-4411	15 x 10 x 5"		1.42	1.32	1.08	1.04	.99	25 / 500	18 lbs.
S-4988	15 x 10 x 6"	200 LB. TEST	1.60	1.44	1.36	1.25	1.18	25 / 500	19 lbs.
S-23308	15 x 10 x 6"	32 ECT LIGHTWEIGHT	1.32	1.18	1.08	1.02	.95	25 / 600	16 lbs.
S-22201	15 x 10 x 7"		1.71	1.57	1.42	1.34	1.26	25 / 500	20 lbs.
S-4719	15 x 10 x 8"		1.81	1.65	1.49	1.40	1.34	25 / 500	21 lbs.
S-4890	15 x 10 x 10"	200 LB. TEST	1.88	1.71	1.57	1.44	1.39	25 / 500	24 lbs.
S-22202	15 x 10 x 10"	32 ECT LIGHTWEIGHT	1.58	1.42	1.31	1.22	1.17	25 / 600	20 lbs.
S-16744	15 x 10 x 12"		1.96	1.79	1.63	1.53	1.46	25 / 250	26 lbs.
S-4877	15 x 10 x 14"		2.04	1.88	1.70	1.61	1.57	25 / 250	28 lbs.
S-21600	15 x 11 x 4"		1.44	1.32	1.15	1.11	1.04	25 / 500	19 lbs.
S-24071	15 x 11 x 5"		1.59	1.47	1.28	1.24	1.17	25 / 600	20 lbs.
S-19084	15 x 11 x 6"		1.71	1.61	1.42	1.36	1.28	25 / 500	21 lbs.
S-4624	15 x 11 x 7"	200 LB. TEST	1.84	1.69	1.50	1.42	1.36	25 / 500	22 lbs.
S-21601	15 x 11 x 7"	32 ECT LIGHTWEIGHT	1.54	1.42	1.25	1.18	1.14	25 / 600	19 lbs.
S-13302	15 x 11 x 9"		1.92	1.71	1.58	1.49	1.40	25 / 500	23 lbs.
S-16745	15 x 11 x 11"		1.96	1.74	1.62	1.53	1.44	25 / 250	27 lbs.
S-351	15 x 11½ x 6"	6,5,4,3,2,1"	1.58	1.42	1.34	1.25	1.18	25 / 500	20 lbs.
S-20477	15 x 12 x 3"		1.49	1.38	1.24	1.22	1.11	25 / 500	19 lbs.
S-4625	15 x 12 x 4"		1.50	1.39	1.25	1.23	1.12	25 / 500	21 lbs.
S-21020	15 x 12 x 5"		1.64	1.53	1.39	1.32	1.23	25 / 500	22 lbs.
S-4234	15 x 12 x 6"	200 LB. TEST	1.81	1.65	1.49	1.40	1.34	25 / 250	23 lbs.
S-21602	15 x 12 x 6"	32 ECT LIGHTWEIGHT	1.52	1.40	1.24	1.17	1.12	25 / 600	19 lbs.
S-22668	15 x 12 x 7"		1.83	1.68	1.50	1.42	1.36	25 / 300	24 lbs.
S-4493	15 x 12 x 8"	200 LB. TEST	1.84	1.69	1.52	1.42	1.37	25 / 250	25 lbs.
S-22203	15 x 12 x 8"	32 ECT LIGHTWEIGHT	1.57	1.40	1.26	1.19	1.14	25 / 300	21 lbs.
<b>S-4153</b>	<b>15 x 12 x 10"</b>	<b>200 LB. FILE BOX</b>	<b>1.40</b>	<b>1.40</b>	<b>1.40</b>	<b>1.40</b>	<b>1.40</b>	<b>25 / 250</b>	<b>28 lbs.</b>
<b>S-20464</b>	<b>15 x 12 x 10"</b>	<b>32 ECT LIGHTWEIGHT</b>	<b>1.15</b>	<b>1.15</b>	<b>1.15</b>	<b>1.15</b>	<b>1.15</b>	<b>25 / 300</b>	<b>23 lbs.</b>
S-13303	15 x 12 x 10"	WHITE FILE BOX	2.38	2.18	2.11	2.02	1.96	25 / 250	28 lbs.
S-4989	15 x 12 x 12"	200 LB. TEST	2.04	1.79	1.65	1.61	1.50	25 / 250	29 lbs.
S-21603	15 x 12 x 12"	32 ECT LIGHTWEIGHT	1.71	1.49	1.40	1.36	1.25	25 / 300	25 lbs.
S-523	15 x 12 x 12"	12,10,8,6"	2.10	1.85	1.71	1.69	1.58	25 / 250	29 lbs.
S-21058	15 x 12 x 14"		2.32	2.08	1.91	1.74	1.63	25 / 250	33 lbs.
S-4839	15 x 13 x 7"		1.85	1.70	1.52	1.42	1.38	25 / 250	26 lbs.



MODEL NO.	INSIDE DIM. L x W x H	VARIABLE DEPTH	PRICE PER BOX					BUNDLE/BALE QTY.	WT./BNDL.
			25	100	250	500	1,000+		
S-23974	15 x 13 x 10"		\$2.06	\$1.83	\$1.69	\$1.61	\$1.52	25 / 300	30 lbs.
S-22204	15 x 13 x 12"		2.20	1.92	1.80	1.74	1.61	25 / 300	33 lbs.
S-16746	15 x 15 x 3"		1.65	1.49	1.39	1.28	1.22	25 / 300	25 lbs.
S-4626	15 x 15 x 4"		1.16	1.16	1.16	1.16	1.16	25 / 250	26 lbs.
S-13304	15 x 15 x 5"		1.73	1.61	1.42	1.38	1.28	25 / 250	27 lbs.
S-4533	15 x 15 x 6"	200 LB. TEST	1.84	1.69	1.50	1.42	1.36	25 / 250	28 lbs.
S-21604	15 x 15 x 6"	32 ECT LIGHTWEIGHT	1.54	1.42	1.25	1.18	1.14	25 / 300	25 lbs.
S-16747	15 x 15 x 7"		2.01	1.81	1.64	1.53	1.44	25 / 250	30 lbs.
S-4891	15 x 15 x 8"		2.07	1.88	1.70	1.58	1.49	25 / 250	31 lbs.
S-25345	15 x 15 x 9"	NEW	2.17	1.97	1.78	1.64	1.55	25 / 250	33 lbs.
S-4390	15 x 15 x 10"	200 LB. TEST	2.26	2.04	1.85	1.70	1.61	20 / 240	28 lbs.
S-19819	15 x 15 x 10"	32 ECT LIGHTWEIGHT	1.92	1.71	1.53	1.42	1.36	25 / 300	29 lbs.
S-22121 •	15 x 15 x 10"	275 LB. TEST DW	4.06	3.75	3.52	3.31	3.13	15 / 180	33 lbs.
S-4494	15 x 15 x 12"	200 LB. TEST	2.53	2.29	2.11	1.92	1.81	25 / 250	36 lbs.
S-22669	15 x 15 x 12"	32 ECT LIGHTWEIGHT	2.13	1.94	1.79	1.61	1.52	25 / 300	31 lbs.
S-4318	15 x 15 x 15"	200 LB. TEST	1.86	1.86	1.86	1.86	1.86	25 / 250	41 lbs.
S-19073	15 x 15 x 15"	32 ECT LIGHTWEIGHT	1.55	1.55	1.55	1.55	1.55	25 / 300	36 lbs.
S-4369	15 x 15 x 15"	15,13,11,9,7"	3.13	2.82	2.64	2.40	2.26	25 / 250	41 lbs.
S-15050 •	15 x 15 x 15"	275 LB. TEST DW	5.03	4.68	4.34	4.09	3.94	15 / 90	39 lbs.
S-4534	15 x 15 x 20"		3.32	3.02	2.76	2.59	2.36	25 / 125	47 lbs.
S-13305	15 x 15 x 24"		3.58	3.32	3.02	2.79	2.60	20 / 140	41 lbs.
S-4412	15 x 15 x 30"		3.88	3.55	3.30	3.02	2.80	15 / 120	37 lbs.
S-15051	15 x 15 x 36"		4.79	4.38	4.07	3.82	3.55	15 / 150	40 lbs.
■ S-4720	15 x 15 x 48"		5.49	5.14	4.86	4.56	4.36	10 / 120	32 lbs.
S-15052	16 x 4 x 4"		.96	.87	.80	.72	.69	25 / 1250	8 lbs.
S-16748	16 x 5 x 5"		1.02	.96	.87	.77	.72	25 / 1000	10 lbs.
S-4990	16 x 6 x 4"		1.04	.98	.90	.80	.75	25 / 750	11 lbs.
S-4348	16 x 6 x 6"		1.17	1.04	.98	.90	.80	25 / 750	13 lbs.
S-14274	16 x 8 x 4"		1.11	.99	.93	.87	.77	25 / 750	14 lbs.
S-4155	16 x 8 x 6"	200 LB. TEST	1.23	1.05	1.02	.92	.84	25 / 500	16 lbs.
S-22670	16 x 8 x 6"	32 ECT LIGHTWEIGHT	1.04	.89	.85	.77	.71	25 / 900	13 lbs.
S-4156	16 x 8 x 8"	200 LB. TEST	1.38	1.23	1.05	1.02	.94	25 / 500	18 lbs.
S-21021	16 x 8 x 8"	32 ECT LIGHTWEIGHT	1.14	1.04	.90	.85	.80	25 / 600	15 lbs.
S-23313	16 x 8 x 10"		1.52	1.38	1.18	1.15	1.04	25 / 600	21 lbs.
S-20489	16 x 8 x 12"		1.62	1.50	1.36	1.28	1.22	25 / 500	23 lbs.
S-4787	16 x 9 x 3"		1.36	1.18	1.04	.99	.92	25 / 500	17 lbs.
S-21059	16 x 9 x 9"		1.53	1.38	1.23	1.15	1.06	25 / 500	21 lbs.
S-4944	16 x 10 x 4"		1.40	1.25	1.04	1.01	.98	25 / 500	17 lbs.
S-21575	16 x 10 x 5"		1.42	1.29	1.06	1.04	1.01	25 / 500	19 lbs.
S-4157	16 x 10 x 6"	200 LB. TEST	.96	.96	.96	.96	.96	25 / 500	20 lbs.
S-20465	16 x 10 x 6"	32 ECT LIGHTWEIGHT	.80	.80	.80	.80	.80	25 / 600	16 lbs.
S-4161	16 x 10 x 8"	200 LB. TEST	1.58	1.42	1.29	1.18	1.05	25 / 500	22 lbs.
S-21022	16 x 10 x 8"	32 ECT LIGHTWEIGHT	1.32	1.18	1.08	.99	.90	25 / 600	19 lbs.
S-4391	16 x 10 x 10"	200 LB. TEST	1.70	1.50	1.39	1.29	1.18	25 / 250	25 lbs.
S-20466	16 x 10 x 10"	32 ECT LIGHTWEIGHT	1.42	1.25	1.15	1.08	.99	25 / 300	20 lbs.
S-21536 •	16 x 10 x 10"	275 LB. TEST DW	2.88	2.67	2.48	2.30	2.21	15 / 180	24 lbs.
S-12597	16 x 10 x 12"		1.98	1.84	1.65	1.58	1.50	25 / 250	27 lbs.
S-15053	16 x 10 x 16"		2.18	1.97	1.81	1.69	1.60	25 / 300	30 lbs.
S-4721	16 x 11 x 9"		1.71	1.52	1.40	1.34	1.23	25 / 250	25 lbs.
S-16749	16 x 11 x 10"		1.81	1.60	1.46	1.40	1.28	25 / 300	26 lbs.
S-20490	16 x 12 x 3"		1.65	1.53	1.40	1.25	1.22	25 / 450	20 lbs.
S-4363	16 x 12 x 4"	200 LB. TEST	1.16	1.16	1.16	1.16	1.16	25 / 375	21 lbs.
S-21023	16 x 12 x 4"	32 ECT LIGHTWEIGHT	.98	.98	.98	.98	.98	25 / 450	18 lbs.
S-23975	16 x 12 x 5"		1.70	1.57	1.42	1.28	1.24	25 / 450	22 lbs.
S-4969	16 x 12 x 6"	200 LB. TEST	1.18	1.18	1.18	1.18	1.18	25 / 300	23 lbs.
S-19820	16 x 12 x 6"	32 ECT LIGHTWEIGHT	.99	.99	.99	.99	.99	25 / 600	20 lbs.
S-4425	16 x 12 x 6"	6,4,2"	2.07	1.85	1.70	1.57	1.42	25 / 250	23 lbs.
S-23960 •	16 x 12 x 6"	275 LB. TEST DW	2.77	2.59	2.39	2.25	2.14	15 / 180	23 lbs.
S-16750	16 x 12 x 7"		1.74	1.58	1.44	1.32	1.25	25 / 300	25 lbs.
S-4235	16 x 12 x 8"	200 LB. TEST	1.22	1.22	1.22	1.22	1.22	25 / 250	25 lbs.
S-18348	16 x 12 x 8"	32 ECT LIGHTWEIGHT	1.03	1.03	1.03	1.03	1.03	25 / 300	21 lbs.
S-15054*	16 x 12 x 8"	275 LB. TEST	2.57	2.36	2.11	1.94	1.84	25 / 250	38 lbs.
S-22581 •	16 x 12 x 8"	275 LB. TEST DW	3.07	2.86	2.65	2.48	2.38	15 / 180	25 lbs.
S-14275	16 x 12 x 9"		1.98	1.84	1.61	1.44	1.39	25 / 250	27 lbs.



S-4412  
15 x 15 x 30"

**ORDER BY 6 PM FOR  
SAME DAY SHIPPING**

**CARTON SIZER**



H-101  
\$17

Reduce boxes to exact size required. Ruled for precise measuring. See page 31.

**LARGER QUANTITIES  
CALL FOR QUOTE**



S-15050  
15 x 15 x 15"  
275 LB. TEST DW

SOLD IN BUNDLE QUANTITIES  
\* 275 LB. TEST  
• 275 LB. TEST DOUBLE WALL (DW)  
■ SHIPS VIA MOTOR FREIGHT

**MORE BOXES**  
→



**38% STRONGER!**

**275# TEST BOXES**

**BEST SELLERS**

- S-4475 12 x 12 x 12"
- S-4635 18 x 12 x 12"
- S-4794 20 x 16 x 14"
- S-4801 24 x 18 x 12"

**LARGER QUANTITIES  
CALL FOR QUOTE**



S-4476

17 1/4 x 11 1/2 x 12" 12,10,8,6"  
DOUBLE REAM BOX

\$1.52 per box any bundle qty.

**OVER 1,700 BOX SIZES  
ALWAYS IN STOCK**



S-14224

18 x 6 x 45"  
FOL, GUITAR BOX

SOLD IN BUNDLE QUANTITIES

\* 275 LB. TEST

• 275 LB. TEST DOUBLE WALL (DW)

MODEL NO.	INSIDE DIM. L x W x H	VARIABLE DEPTH	PRICE PER BOX					BUNDLE/BALE QTY.	WT./BNDL.
			25	100	250	500	1,000+		
S-4160	16 x 12 x 10"	200 LB. TEST	\$1.34	\$1.34	\$1.34	\$1.34	\$1.34	25 / 250	29 lbs.
S-19074	16 x 12 x 10"	32 ECT LIGHTWEIGHT	1.12	1.12	1.12	1.12	1.12	25 / 300	25 lbs.
S-16517•	16 x 12 x 10"	275 LB. TEST DW	3.35	3.13	2.91	2.71	2.60	15 / 180	27 lbs.
S-22191	16 x 12 x 11"		2.16	1.99	1.74	1.57	1.46	25 / 300	30 lbs.
S-4163	16 x 12 x 12"	200 LB. TEST	1.42	1.42	1.42	1.42	1.42	25 / 250	31 lbs.
S-18349	16 x 12 x 12"	32 ECT LIGHTWEIGHT	1.19	1.19	1.19	1.19	1.19	25 / 300	25 lbs.
S-539	16 x 12 x 12"	12,10,8,6"	2.43	2.18	1.97	1.88	1.81	25 / 250	31 lbs.
S-20487	16 x 12 x 12"	WHITE	2.43	2.26	2.17	2.10	2.04	25 / 300	31 lbs.
S-13306*	16 x 12 x 12"	275 LB. TEST	3.03	2.75	2.50	2.29	2.11	25 / 250	45 lbs.
S-4788•	16 x 12 x 12"	275 LB. TEST DW	3.66	3.36	3.14	2.96	2.80	15 / 180	28 lbs.
S-21054	16 x 12 x 14"		2.39	2.16	1.97	1.81	1.70	25 / 250	34 lbs.
S-19821	16 x 12 x 16"		2.69	2.44	2.18	2.05	1.96	25 / 250	36 lbs.
S-22657	16 x 12 x 18"		2.82	2.54	2.32	2.18	2.08	25 / 250	39 lbs.
S-13307	16 x 13 x 13"	200 LB. TEST	2.38	2.11	1.92	1.73	1.65	25 / 250	33 lbs.
S-23314	16 x 13 x 13"	32 ECT LIGHTWEIGHT	1.98	1.79	1.61	1.46	1.39	25 / 300	29 lbs.
S-25348	16 x 14 x 3"	32 ECT LIGHTWEIGHT NEW	1.39	1.34	1.24	1.15	1.11	25 / 450	20 lbs.
S-4991	16 x 14 x 4"		1.79	1.64	1.49	1.39	1.34	25 / 300	24 lbs.
S-4892	16 x 14 x 6"	200 LB. TEST	1.92	1.71	1.57	1.42	1.38	25 / 250	27 lbs.
S-22205	16 x 14 x 6"	32 ECT LIGHTWEIGHT	1.61	1.42	1.31	1.19	1.16	25 / 300	24 lbs.
S-4564	16 x 14 x 8"	200 LB. TEST	1.96	1.74	1.61	1.49	1.42	25 / 250	30 lbs.
S-21607	16 x 14 x 8"	32 ECT LIGHTWEIGHT	1.63	1.47	1.36	1.24	1.18	25 / 300	26 lbs.
S-4392	16 x 14 x 10"	200 LB. TEST	2.33	2.11	1.92	1.74	1.65	25 / 250	34 lbs.
S-19822	16 x 14 x 10"	32 ECT LIGHTWEIGHT	1.95	1.79	1.60	1.47	1.40	25 / 300	28 lbs.
S-4151	16 x 14 x 12"	200 LB. TEST	2.44	2.18	1.98	1.84	1.71	25 / 250	36 lbs.
S-21608	16 x 14 x 12"	32 ECT LIGHTWEIGHT	2.05	1.85	1.65	1.54	1.44	25 / 300	30 lbs.
S-12598	16 x 14 x 14"		2.64	2.38	2.10	1.97	1.85	25 / 250	38 lbs.
S-22658	16 x 14 x 18"		3.11	2.80	2.49	2.32	2.20	25 / 125	44 lbs.
S-4856	16 x 16 x 3"		1.84	1.70	1.57	1.42	1.40	25 / 250	27 lbs.
S-4535	16 x 16 x 4"	200 LB. TEST	1.85	1.71	1.58	1.44	1.42	25 / 250	28 lbs.
S-21019	16 x 16 x 4"	32 ECT LIGHTWEIGHT	1.54	1.44	1.32	1.22	1.18	25 / 300	25 lbs.
S-15055	16 x 16 x 5"		1.97	1.79	1.69	1.60	1.49	25 / 300	30 lbs.
S-4536	16 x 16 x 6"	200 LB. TEST	1.44	1.44	1.44	1.44	1.44	25 / 250	31 lbs.
S-20467	16 x 16 x 6"	32 ECT LIGHTWEIGHT	1.22	1.22	1.22	1.22	1.22	25 / 300	27 lbs.
S-4495	16 x 16 x 6"	6,4,2"	2.18	2.02	1.88	1.74	1.61	25 / 250	31 lbs.
S-22122•	16 x 16 x 6"	275 LB. TEST DW	3.83	3.54	3.30	3.10	2.95	15 / 180	32 lbs.
S-21055	16 x 16 x 7"		2.22	2.07	1.92	1.81	1.64	25 / 250	34 lbs.
S-4393	16 x 16 x 8"	200 LB. TEST	1.60	1.60	1.60	1.60	1.60	25 / 250	34 lbs.
S-18350	16 x 16 x 8"	32 ECT LIGHTWEIGHT	1.34	1.34	1.34	1.34	1.34	25 / 300	29 lbs.
S-13308•	16 x 16 x 8"	275 LB. TEST DW	4.16	3.86	3.56	3.35	3.21	15 / 180	32 lbs.
S-4537	16 x 16 x 9"		2.54	2.29	2.10	1.94	1.79	25 / 250	35 lbs.
S-4164	16 x 16 x 10"	200 LB. TEST	1.75	1.75	1.75	1.75	1.75	25 / 250	36 lbs.
S-19075	16 x 16 x 10"	32 ECT LIGHTWEIGHT	1.45	1.45	1.45	1.45	1.45	25 / 300	33 lbs.
S-16518•	16 x 16 x 10"	275 LB. TEST DW	4.50	4.17	3.87	3.64	3.52	15 / 90	36 lbs.
S-4538	16 x 16 x 11"		2.80	2.53	2.30	2.14	1.97	25 / 250	37 lbs.
S-4165	16 x 16 x 12"	200 LB. TEST	2.07	2.07	2.07	2.07	2.07	25 / 250	41 lbs.
S-19823	16 x 16 x 12"	32 ECT LIGHTWEIGHT	1.73	1.73	1.73	1.73	1.73	25 / 300	34 lbs.
S-11253•	16 x 16 x 12"	275 LB. TEST DW	4.84	4.49	4.16	3.89	3.75	10 / 90	25 lbs.
S-21056	16 x 16 x 13"		3.03	2.73	2.48	2.29	2.14	25 / 150	43 lbs.
S-4893	16 x 16 x 14"		3.14	2.82	2.54	2.36	2.18	25 / 125	43 lbs.
S-4166	16 x 16 x 16"	200 LB. TEST	2.04	2.04	2.04	2.04	2.04	25 / 125	47 lbs.
S-18351	16 x 16 x 16"	32 ECT LIGHTWEIGHT	1.74	1.74	1.74	1.74	1.74	25 / 150	38 lbs.
S-4370	16 x 16 x 16"	16,14,12,10,8"	3.66	3.22	2.99	2.73	2.53	25 / 125	47 lbs.
S-4933	16 x 16 x 16"	WHITE	3.77	3.42	3.13	2.85	2.73	25 / 125	47 lbs.
S-4627*	16 x 16 x 16"	275 LB. TEST	4.16	3.69	3.46	3.19	3.10	25 / 125	66 lbs.
S-4774•	16 x 16 x 16"	275 LB. TEST DW	4.42	4.42	4.42	4.42	4.42	15 / 90	45 lbs.
S-18917	16 x 16 x 16"	500 LB. TEST DW	12.60	11.83	11.10	10.41	9.67	15 / 75	69 lbs.
S-21057	16 x 16 x 18"		3.58	3.25	3.09	2.92	2.67	25 / 150	50 lbs.
S-21537•	16 x 16 x 18"	275 LB. TEST DW	6.30	5.88	5.47	5.16	4.93	15 / 90	48 lbs.
S-4565	16 x 16 x 19"		3.71	3.35	3.14	3.00	2.73	25 / 125	50 lbs.
S-4628	16 x 16 x 20"		3.93	3.55	3.35	3.19	2.95	20 / 120	40 lbs.
S-23315•	16 x 16 x 20"	275 LB. TEST DW	6.66	6.22	5.78	5.46	5.22	15 / 90	50 lbs.
S-20483	16 x 16 x 22"		4.09	3.75	3.53	3.32	3.03	20 / 140	45 lbs.
S-16751	16 x 16 x 24"		4.22	3.94	3.67	3.41	3.14	15 / 120	35 lbs.
S-4629	16 x 16 x 26"		4.47	4.14	3.87	3.56	3.32	10 / 120	25 lbs.



MODEL NO.	INSIDE DIM. L x W x H /	VARIABLE DEPTH	PRICE PER BOX					BUNDLE/BALE QTY.	WT./BNDL.
			25	100	250	500	1,000+		
S-19081	16 x 16 x 30"	TELESCOPIC	\$4.86	\$4.50	\$4.22	\$3.93	\$3.63	15 / 150	40 lbs.
S-4894	16 x 16 x 36"		5.46	5.12	4.79	4.47	4.07	10 / 120	30 lbs.
S-11249	16 x 16 x 40 - 74"		11.26	10.57	10.02	9.30	8.64	10 / 120	59 lbs.
■S-16752	16 x 16 x 48"		6.44	6.02	5.76	5.32	4.92	10 / 120	37 lbs.
S-4992	17 x 6 x 6"		1.11	1.02	.96	.84	.77	25 / 750	14 lbs.
S-22206	17 x 7 x 7"		1.34	1.23	1.17	1.02	.94	25 / 750	16 lbs.
S-4630	17 x 9 x 9"		1.70	1.49	1.39	1.24	1.12	25 / 500	21 lbs.
S-19837	17 x 11 x 8"		1.73	1.62	1.47	1.38	1.28	25 / 500	25 lbs.
S-19082	17 x 12 x 6"		1.75	1.65	1.52	1.40	1.36	25 / 300	25 lbs.
S-23316	17 x 12 x 8"		1.85	1.73	1.59	1.47	1.38	25 / 300	27 lbs.
S-16753	17 x 12 x 10"	1.90	1.79	1.63	1.53	1.46	25 / 300	30 lbs.	
S-13309	17 x 12 x 12"	2.02	1.94	1.73	1.63	1.57	25 / 250	31 lbs.	
S-24745	17 x 13 x 3"	1.74	1.65	1.53	1.40	1.36	25 / 500	23 lbs.	
S-4755	17 x 13 x 5"	1.79	1.70	1.57	1.42	1.38	25 / 500	25 lbs.	
S-18388	17 x 13 x 7"	1.98	1.92	1.73	1.60	1.52	25 / 300	28 lbs.	
S-23976	17 x 13 x 9"	2.08	1.99	1.81	1.68	1.59	25 / 300	30 lbs.	
S-4723	17 x 13 x 13"	2.29	2.14	1.97	1.84	1.71	25 / 250	33 lbs.	
S-13310	17 x 14 x 5"	1.98	1.85	1.69	1.58	1.49	25 / 300	26 lbs.	
S-4791	17 x 14 x 9"	2.18	2.10	1.94	1.79	1.69	25 / 250	32 lbs.	
S-19083	17 x 14 x 10"	2.25	2.14	1.95	1.81	1.70	25 / 300	35 lbs.	
S-20484	17 x 14 x 14"	2.60	2.43	2.26	2.10	1.97	25 / 300	40 lbs.	
S-16754	17 x 17 x 4"	2.18	2.04	1.94	1.75	1.65	25 / 300	33 lbs.	
S-18389	17 x 17 x 6"	2.80	2.44	2.18	2.04	1.90	25 / 300	36 lbs.	
S-23317	17 x 17 x 7"	2.90	2.53	2.27	2.10	1.95	25 / 300	38 lbs.	
S-4395	17 x 17 x 8"	2.99	2.60	2.33	2.16	1.98	20 / 240	32 lbs.	
S-19838	17 x 17 x 9"	3.01	2.61	2.38	2.17	2.02	25 / 300	41 lbs.	
S-11376	17 x 17 x 10"	3.03	2.64	2.38	2.18	2.04	25 / 250	42 lbs.	
S-4857	17 x 17 x 12"	3.11	2.68	2.43	2.26	2.07	25 / 250	46 lbs.	
S-4445	17 x 17 x 14"	3.19	2.75	2.50	2.30	2.14	25 / 250	49 lbs.	
S-4172	17 x 17 x 17"	200 LB. TEST	3.63	3.21	2.95	2.68	2.53	25 / 150	53 lbs.
S-21018	17 x 17 x 17"	32 ECT LIGHTWEIGHT	3.02	2.71	2.49	2.22	2.11	25 / 150	44 lbs.
S-4446	17 x 17 x 17"	17,15,13,11"	3.72	3.36	3.14	2.91	2.69	25 / 150	53 lbs.
S-18163•	17 x 17 x 17"	275 LB. TEST DW	6.44	5.97	5.52	5.20	4.97	10 / 90	33 lbs.
S-4173	17 1/4 x 11 1/4 x 6"	DBL. REAM	1.79	1.58	1.42	1.36	1.23	25 / 500	23 lbs.
S-4756	17 1/4 x 11 1/4 x 7"	DBL. REAM	1.81	1.64	1.44	1.38	1.25	25 / 500	24 lbs.
S-4175	17 1/4 x 11 1/4 x 8"	200 LB. DBL. REAM	1.29	1.29	1.29	1.29	1.29	25 / 500	26 lbs.
S-19839	17 1/4 x 11 1/4 x 8"	32 ECT LIGHTWEIGHT	1.03	1.03	1.03	1.03	1.03	25 / 600	21 lbs.
S-13311*	17 1/4 x 11 1/4 x 8"	275 LB. TEST	2.32	2.11	2.02	1.88	1.73	25 / 250	36 lbs.
S-15046	17 1/4 x 11 1/4 x 9"	DBL. REAM	1.97	1.73	1.63	1.42	1.36	25 / 300	26 lbs.
S-4176	17 1/4 x 11 1/4 x 10"	DBL. REAM	2.04	1.81	1.69	1.50	1.39	25 / 250	28 lbs.
S-4858*	17 1/4 x 11 1/4 x 10"	275 LB. TEST	2.44	2.29	2.16	2.02	1.92	25 / 250	41 lbs.
S-4177	17 1/4 x 11 1/4 x 11 1/2"	DBL. REAM	2.10	1.85	1.70	1.57	1.42	25 / 250	30 lbs.
S-4789*	17 1/4 x 11 1/4 x 12"	275 LB. TEST	2.64	2.49	2.33	2.16	2.05	25 / 250	43 lbs.
S-4631	17 1/4 x 11 1/4 x 14 1/4"	DBL. REAM	2.50	2.26	2.04	1.88	1.73	20 / 240	24 lbs.
S-4426	17 1/4 x 11 1/2 x 6"	6,4,2"	2.04	1.81	1.69	1.50	1.39	25 / 250	23 lbs.
S-4476	17 1/4 x 11 1/2 x 12"	12,10,8,6" 200 LB. TEST	1.52	1.52	1.52	1.52	1.52	25 / 250	30 lbs.
S-21609	17 1/4 x 11 1/2 x 12"	12,10,8,6" 32 ECT	1.29	1.29	1.29	1.29	1.29	25 / 300	26 lbs.
S-4722	17 1/2 x 12 x 3"		1.92	1.73	1.58	1.49	1.40	25 / 500	21 lbs.
S-4539	17 1/2 x 14 1/4 x 12 1/2"		2.85	2.50	2.29	2.10	1.96	25 / 125	39 lbs.
S-14276	18 x 4 x 4"		.94	.90	.80	.71	.65	25 / 1000	9 lbs.
S-4154	18 x 6 x 4"		1.04	.96	.90	.80	.72	25 / 500	12 lbs.
S-4178	18 x 6 x 6"	200 LB. TEST	1.05	.98	.92	.82	.75	25 / 750	14 lbs.
S-22639	18 x 6 x 6"	32 ECT LIGHTWEIGHT	.89	.83	.77	.68	.64	25 / 900	11 lbs.
S-14224*	18 x 6 x 45"	FOL, GUITAR BOX	11.01	10.35	9.62	8.70	8.39	5 / 120	16 lbs.
S-23977	18 x 7 x 7"		1.39	1.24	1.18	1.04	.95	25 / 750	17 lbs.
S-18000*	18 x 7 x 52"	FOL, GUITAR BOX	12.54	11.80	11.01	9.98	9.57	5 / 120	21 lbs.
S-19840	18 x 8 x 4"		1.28	1.18	1.02	.99	.93	25 / 500	15 lbs.
S-4313	18 x 8 x 6"		1.36	1.23	1.05	1.02	.96	25 / 500	17 lbs.
S-4818	18 x 8 x 8"		1.60	1.42	1.25	1.17	1.11	25 / 500	19 lbs.
S-4632	18 x 9 x 9"		1.79	1.61	1.42	1.34	1.23	25 / 250	22 lbs.
S-4724	18 x 10 x 4"		1.50	1.38	1.24	1.08	.99	25 / 500	18 lbs.
S-4179	18 x 10 x 6"	200 LB. TEST	1.64	1.42	1.34	1.18	1.06	25 / 500	21 lbs.
S-22640	18 x 10 x 6"	32 ECT LIGHTWEIGHT	1.39	1.19	1.12	.99	.90	25 / 600	17 lbs.
S-4182	18 x 10 x 8"		1.79	1.61	1.42	1.34	1.23	25 / 250	22 lbs.



S-16751  
16 x 16 x 24"  
TALL BOX

**SEE RED AND SAVE ON POPULAR SIZES !**



S-4818  
18 x 8 x 8"

**ORDER BY 6 PM FOR SAME DAY SHIPPING**



S-16752  
16 x 16 x 48"

SOLD IN BUNDLE QUANTITIES  
\* 275 LB. TEST  
• 275 LB. TEST DOUBLE WALL (DW)  
FOL = FULL OVERLAP  
■ SHIPS VIA MOTOR FREIGHT

**MORE BOXES**  
→



S-4638  
18 x 18 x 36"

**OVER 1,700 BOX SIZES  
ALWAYS IN STOCK**



**18 x 18 x 18"  
CUBE BOXES**

- S-4185 200 lb. Test
- S-18356 32 ECT
- S-4371 Multi-depth
- S-11262 White
- S-4730 275 lb. Test
- S-4731 275 lb. Test DW

**SEE RED AND SAVE  
ON POPULAR SIZES !**



S-12601  
20 x 4 x 4"  
LONG BOX

SOLD IN BUNDLE QUANTITIES

\* 275 LB. TEST

• 275 LB. TEST DOUBLE WALL (DW)

MODEL NO.	INSIDE DIM. L x W x H	VARIABLE DEPTH	PRICE PER BOX					BUNDLE/BALE QTY.	WT./BNDL.
			25	100	250	500	1,000+		
S-4496	18 x 10 x 10"	200 LB. TEST	\$1.96	\$1.81	\$1.70	\$1.61	\$1.49	25 / 250	25 lbs.
S-22641	18 x 10 x 10"	32 ECT LIGHTWEIGHT	1.64	1.52	1.42	1.36	1.25	25 / 300	21 lbs.
S-23324	18 x 10 x 12"		2.05	1.91	1.76	1.65	1.54	25 / 300	29 lbs.
S-4920	18 x 12 x 2"		1.69	1.62	1.49	1.38	1.32	25 / 250	20 lbs.
S-19080	18 x 12 x 3"		1.70	1.63	1.50	1.39	1.34	25 / 450	21 lbs.
S-4859	18 x 12 x 4"	200 LB. TEST	1.71	1.64	1.52	1.40	1.36	25 / 250	22 lbs.
S-22585	18 x 12 x 4"	32 ECT LIGHTWEIGHT	1.44	1.39	1.27	1.18	1.14	25 / 450	19 lbs.
S-4633	18 x 12 x 5"		1.84	1.73	1.61	1.49	1.40	25 / 250	23 lbs.
S-4187	18 x 12 x 6"	200 LB. TEST	1.37	1.37	1.37	1.37	1.37	25 / 250	25 lbs.
S-18352	18 x 12 x 6"	32 ECT LIGHTWEIGHT	1.16	1.16	1.16	1.16	1.16	25 / 300	21 lbs.
S-4427	18 x 12 x 6"	6,4,2"	2.18	1.97	1.81	1.69	1.57	25 / 250	25 lbs.
S-12599	18 x 12 x 6"	WHITE	2.40	2.16	2.02	1.92	1.73	25 / 250	25 lbs.
S-19772*	18 x 12 x 6"	275 LB. TEST DW	3.00	2.79	2.60	2.48	2.38	15 / 180	25 lbs.
S-4993	18 x 12 x 7"		1.92	1.79	1.65	1.57	1.46	25 / 250	27 lbs.
S-4188	18 x 12 x 8"	200 LB. BOOK BOX	1.41	1.41	1.41	1.41	1.41	25 / 250	28 lbs.
S-19076	18 x 12 x 8"	32 ECT LIGHTWEIGHT	1.18	1.18	1.18	1.18	1.18	25 / 300	24 lbs.
S-18949	18 x 12 x 8"	WHITE	2.43	2.21	2.11	2.04	1.95	25 / 250	28 lbs.
S-4896*	18 x 12 x 8"	275 LB. TEST DW	3.22	3.00	2.79	2.61	2.53	15 / 180	25 lbs.
S-4497	18 x 12 x 9"	200 LB. TEST	1.97	1.84	1.71	1.64	1.50	25 / 250	29 lbs.
S-23325	18 x 12 x 9"	32 ECT LIGHTWEIGHT	1.65	1.54	1.44	1.39	1.26	25 / 300	24 lbs.
S-4189	18 x 12 x 10"	200 LB. TEST	1.44	1.44	1.44	1.44	1.44	25 / 250	31 lbs.
S-19842	18 x 12 x 10"	32 ECT LIGHTWEIGHT	1.22	1.22	1.22	1.22	1.22	25 / 300	25 lbs.
S-14230*	18 x 12 x 10"	275 LB. TEST DW	3.56	3.32	3.10	2.90	2.75	15 / 180	28 lbs.
S-4181	18 x 12 x 12"	200 LB. TEST	1.48	1.48	1.48	1.48	1.48	25 / 250	33 lbs.
S-18353	18 x 12 x 12"	32 ECT LIGHTWEIGHT	1.24	1.24	1.24	1.24	1.24	25 / 300	27 lbs.
S-540	18 x 12 x 12"	12,10,8,6"	2.32	2.17	2.07	2.02	1.96	25 / 250	33 lbs.
S-4634	18 x 12 x 12"	WHITE	2.44	2.30	2.18	2.16	2.10	25 / 250	33 lbs.
S-4635*	18 x 12 x 12"	275 LB. TEST	2.80	2.66	2.50	2.33	2.18	25 / 250	47 lbs.
S-4725*	18 x 12 x 12"	275 LB. TEST DW	2.86	2.86	2.86	2.86	2.86	15 / 180	29 lbs.
S-4237	18 x 12 x 14"	200 LB. TEST	2.29	2.14	1.97	1.84	1.71	25 / 250	35 lbs.
S-21552	18 x 12 x 14"	32 ECT LIGHTWEIGHT	1.92	1.81	1.64	1.54	1.44	25 / 300	30 lbs.
S-4897	18 x 12 x 16"		2.49	2.32	2.14	1.98	1.88	25 / 250	38 lbs.
S-4898	18 x 12 x 18"		2.69	2.50	2.36	2.26	2.14	25 / 125	40 lbs.
S-23980	18 x 12 x 20"		2.88	2.67	2.51	2.39	2.28	25 / 125	44 lbs.
S-19843	18 x 13 x 5"		1.91	1.79	1.63	1.52	1.42	25 / 300	26 lbs.
S-13312	18 x 13 x 12"		2.26	2.10	1.94	1.81	1.70	25 / 250	34 lbs.
S-25349	18 x 14 x 3"	32 ECT LIGHTWEIGHT NEW	1.45	1.40	1.28	1.20	1.15	25 / 300	21 lbs.
S-4757	18 x 14 x 4"	200 LB. TEST	1.70	1.61	1.49	1.40	1.36	25 / 250	24 lbs.
S-22642	18 x 14 x 4"	32 ECT LIGHTWEIGHT	1.47	1.42	1.29	1.22	1.16	25 / 300	22 lbs.
S-4726	18 x 14 x 6"	200 LB. TEST	1.84	1.73	1.61	1.49	1.40	25 / 250	29 lbs.
S-20468	18 x 14 x 6"	32 ECT LIGHTWEIGHT	1.53	1.46	1.34	1.24	1.17	25 / 300	25 lbs.
S-4397	18 x 14 x 8"	200 LB. TEST	1.52	1.52	1.52	1.52	1.52	20 / 240	27 lbs.
S-21024	18 x 14 x 8"	32 ECT LIGHTWEIGHT	1.28	1.28	1.28	1.28	1.28	25 / 300	27 lbs.
S-4540	18 x 14 x 10"	200 LB. TEST	2.33	2.21	2.02	1.95	1.79	25 / 250	34 lbs.
S-19844	18 x 14 x 10"	32 ECT LIGHTWEIGHT	1.95	1.88	1.69	1.62	1.50	25 / 300	29 lbs.
S-18922*	18 x 14 x 10"	275 LB. TEST DW	4.17	3.87	3.56	3.36	3.22	15 / 180	34 lbs.
S-4183	18 x 14 x 12"	200 LB. TEST	1.78	1.78	1.78	1.78	1.78	20 / 240	31 lbs.
S-18354	18 x 14 x 12"	32 ECT LIGHTWEIGHT	1.46	1.46	1.46	1.46	1.46	25 / 300	31 lbs.
S-13313*	18 x 14 x 12"	275 LB. TEST DW	4.50	4.17	3.87	3.66	3.52	15 / 180	35 lbs.
S-4191	18 x 14 x 14"	200 LB. TEST	2.68	2.49	2.33	2.18	2.11	20 / 240	32 lbs.
S-19845	18 x 14 x 14"	32 ECT LIGHTWEIGHT	2.25	2.07	1.95	1.85	1.79	25 / 300	34 lbs.
S-14231*	18 x 14 x 14"	275 LB. TEST DW	5.03	4.68	4.32	4.07	3.88	15 / 90	40 lbs.
S-22643	18 x 14 x 18"		3.14	2.92	2.77	2.65	2.53	25 / 125	47 lbs.
S-559	18 x 14 1/2 x 12"	12,10,8,6"	2.76	2.60	2.40	2.26	2.14	25 / 250	41 lbs.
S-23981	18 x 15 x 15"		2.86	2.69	2.54	2.39	2.27	25 / 150	45 lbs.
S-4727	18 x 16 x 2"		2.02	1.91	1.71	1.62	1.57	25 / 250	27 lbs.
S-4820	18 x 16 x 4"		2.05	1.92	1.73	1.64	1.58	25 / 250	30 lbs.
S-4566	18 x 16 x 6"	200 LB. TEST	2.10	1.96	1.81	1.70	1.64	25 / 250	33 lbs.
S-23322	18 x 16 x 6"	32 ECT LIGHTWEIGHT	1.76	1.64	1.52	1.42	1.39	25 / 300	28 lbs.
S-4792	18 x 16 x 8"		2.38	2.16	2.02	1.88	1.74	25 / 250	37 lbs.
S-4184	18 x 16 x 10"	200 LB. TEST	2.73	2.44	2.26	2.11	1.96	20 / 240	33 lbs.
S-22644	18 x 16 x 10"	32 ECT LIGHTWEIGHT	2.29	2.06	1.90	1.79	1.64	25 / 300	33 lbs.
S-4728	18 x 16 x 12"	200 LB. TEST	2.79	2.59	2.40	2.18	2.04	25 / 250	43 lbs.
S-21546	18 x 16 x 12"	32 ECT LIGHTWEIGHT	2.36	2.18	2.04	1.85	1.71	25 / 300	37 lbs.



MODEL NO.	INSIDE DIM. L x W x H	VARIABLE DEPTH	PRICE PER BOX					BUNDLE/BALE QTY.	WT./BNDL.
			25	100	250	500	1,000+		
S-4238	18 x 16 x 14"	200 LB. TEST	\$2.82	\$2.68	\$2.53	\$2.38	\$2.26	25 / 250	45 lbs.
S-20469	18 x 16 x 14"	32 ECT LIGHTWEIGHT	2.39	2.22	2.11	1.98	1.91	25 / 300	39 lbs.
S-21538•	18 x 16 x 14"	275 LB. TEST DW	5.70	5.29	4.90	4.61	4.39	15 / 90	45 lbs.
S-12600	18 x 16 x 16"		3.03	2.90	2.73	2.59	2.40	20 / 140	38 lbs.
S-20479	18 x 18 x 2"		2.44	2.29	2.18	2.02	1.94	25 / 300	33 lbs.
S-22170	18 x 18 x 3"		2.48	2.30	2.21	2.04	1.95	25 / 300	35 lbs.
S-4541	18 x 18 x 4"	200 LB. TEST	2.49	2.32	2.22	2.05	1.95	25 / 250	36 lbs.
S-22586	18 x 18 x 4"	32 ECT LIGHTWEIGHT	2.08	1.95	1.86	1.73	1.61	25 / 300	30 lbs.
S-21027	18 x 18 x 5"		2.57	2.40	2.34	2.14	1.96	25 / 250	38 lbs.
S-4398	18 x 18 x 6"	200 LB. TEST	1.85	1.85	1.85	1.85	1.85	20 / 240	32 lbs.
S-20470	18 x 18 x 6"	32 ECT LIGHTWEIGHT	1.55	1.55	1.55	1.55	1.55	25 / 300	33 lbs.
S-4793	18 x 18 x 6"	6,4,2"	2.96	2.73	2.59	2.44	2.29	20 / 240	32 lbs.
S-19773•	18 x 18 x 6"	275 LB. TEST DW	4.84	4.55	4.20	3.97	3.77	15 / 180	38 lbs.
S-22661	18 x 18 x 7"		2.72	2.57	2.43	2.29	2.11	25 / 300	41 lbs.
S-4239	18 x 18 x 8"	200 LB. TEST	2.82	2.68	2.53	2.38	2.26	25 / 250	43 lbs.
S-21556	18 x 18 x 8"	32 ECT LIGHTWEIGHT	2.38	2.25	2.11	2.01	1.91	25 / 300	36 lbs.
S-14232•	18 x 18 x 8"	275 LB. TEST DW	5.24	4.90	4.55	4.27	4.09	15 / 90	41 lbs.
S-4468	18 x 18 x 10"	200 LB. TEST	2.99	2.75	2.60	2.43	2.30	20 / 240	37 lbs.
S-21025	18 x 18 x 10"	32 ECT LIGHTWEIGHT	2.51	2.32	2.18	2.04	1.92	25 / 300	39 lbs.
S-20410•	18 x 18 x 10"	275 LB. TEST DW	5.54	5.18	4.79	4.49	4.32	15 / 90	44 lbs.
S-4399	18 x 18 x 12"	200 LB. TEST	2.21	2.21	2.21	2.21	2.21	20 / 240	38 lbs.
S-18355	18 x 18 x 12"	32 ECT LIGHTWEIGHT	1.85	1.85	1.85	1.85	1.85	25 / 300	40 lbs.
S-4636	18 x 18 x 12"	12,10,8,6"	3.54	3.32	3.13	2.99	2.76	20 / 120	38 lbs.
S-4771*	18 x 18 x 12"	275 LB. TEST	4.05	3.71	3.54	3.36	3.21	25 / 125	63 lbs.
S-4968•	18 x 18 x 12"	275 LB. TEST DW	4.28	4.28	4.28	4.28	4.28	10 / 90	30 lbs.
S-4729	18 x 18 x 14"		3.22	2.96	2.79	2.59	2.43	20 / 240	42 lbs.
S-13314	18 x 18 x 15"		3.35	3.02	2.90	2.67	2.51	20 / 140	41 lbs.
S-4456	18 x 18 x 16"	200 LB. 3 CU. FT.	2.40	2.40	2.40	2.40	2.40	20 / 120	48 lbs.
S-21026	18 x 18 x 16"	32 ECT LIGHTWEIGHT	2.02	2.02	2.02	2.02	2.02	20 / 140	38 lbs.
S-18923•	18 x 18 x 16"	275 LB. TEST DW	6.46	6.07	5.62	5.24	4.90	10 / 90	36 lbs.
S-4185	18 x 18 x 18"	200 LB. TEST	2.55	2.55	2.55	2.55	2.55	20 / 120	48 lbs.
S-18356	18 x 18 x 18"	32 ECT LIGHTWEIGHT	2.13	2.13	2.13	2.13	2.13	20 / 140	38 lbs.
S-4371	18 x 18 x 18"	18,16,14,12,10"	2.84	2.84	2.84	2.84	2.84	20 / 120	48 lbs.
S-11262	18 x 18 x 18"	WHITE	4.63	4.22	4.05	3.83	3.63	20 / 120	48 lbs.
S-4730*	18 x 18 x 18"	275 LB. TEST	5.26	4.72	4.49	4.14	3.89	10 / 120	32 lbs.
S-4731•	18 x 18 x 18"	275 LB. TEST DW	4.89	4.89	4.89	4.89	4.89	10 / 90	36 lbs.
S-4637	18 x 18 x 20"		3.89	3.58	3.49	3.14	2.96	15 / 120	36 lbs.
S-4338	18 x 18 x 24"	200 LB. 4½ CU. FT.	3.05	3.05	3.05	3.05	3.05	15 / 120	41 lbs.
S-21557	18 x 18 x 24"	32 ECT LIGHTWEIGHT	2.57	2.57	2.57	2.57	2.57	15 / 150	35 lbs.
S-11254•	18 x 18 x 24"	275 LB. TEST DW	8.19	7.32	6.94	6.37	6.07	10 / 90	42 lbs.
S-4758	18 x 18 x 28"		4.66	4.38	4.16	3.99	3.66	10 / 120	28 lbs.
S-4676	18 x 18 x 28"	350 LB. TEST DW	9.74	9.30	8.89	8.46	8.04	5 / 75	23 lbs.
■S-15045	18 x 18 x 30"		5.23	4.83	4.61	4.36	4.00	15 / 150	45 lbs.
■S-22662	18 x 18 x 34"		5.95	5.33	5.20	4.83	4.41	10 / 150	34 lbs.
■S-4638	18 x 18 x 36"		6.18	5.54	5.40	5.02	4.59	10 / 120	35 lbs.
■S-20428	18 x 18 x 40 - 74"	TELESCOPIC	13.07	12.26	11.61	10.80	10.02	10 / 150	64 lbs.
■S-11377	18 x 18 x 48"		6.97	6.24	6.10	5.60	5.18	10 / 120	42 lbs.
S-13315	18½ x 12½ x 7"		1.97	1.81	1.70	1.63	1.50	25 / 250	27 lbs.
S-4759	18½ x 12½ x 9"		2.04	1.88	1.74	1.69	1.57	20 / 240	24 lbs.
S-4760	18½ x 12½ x 12"		2.17	2.07	1.98	1.96	1.69	20 / 240	27 lbs.
S-4696	18½ x 18½ x 9"		2.99	2.76	2.60	2.43	2.32	20 / 240	37 lbs.
S-16757	19 x 6 x 4"		1.12	1.02	.98	.92	.80	25 / 1000	12 lbs.
S-4761	19 x 12 x 3"		1.73	1.64	1.57	1.42	1.34	25 / 500	24 lbs.
S-4899	19 x 12 x 4"		1.74	1.65	1.58	1.42	1.36	25 / 250	25 lbs.
S-19846	19 x 12 x 7"		1.97	1.84	1.71	1.61	1.49	25 / 300	28 lbs.
S-23982	19 x 13 x 4"		1.83	1.71	1.61	1.49	1.39	25 / 450	26 lbs.
S-20482	19 x 13 x 6"		2.04	1.91	1.79	1.64	1.53	25 / 300	28 lbs.
S-22663	19 x 13 x 8"		2.25	2.10	1.96	1.83	1.69	25 / 300	31 lbs.
S-22192	19 x 13 x 10"		2.44	2.29	2.14	1.99	1.84	25 / 300	34 lbs.
S-22596	19 x 13 x 12"	12,10,8,6"	2.76	2.61	2.43	2.26	2.14	25 / 300	37 lbs.
S-16760	19 x 13 x 13"		2.64	2.40	2.26	2.07	1.95	25 / 250	38 lbs.
S-4860	19 x 19 x 19"		4.14	3.77	3.67	3.34	3.13	10 / 120	27 lbs.
S-12601	20 x 4 x 4"		.99	.94	.82	.75	.71	25 / 1000	9 lbs.
S-4498	20 x 5 x 5"		1.11	1.02	.93	.85	.75	25 / 1000	12 lbs.



## FLAT BOXES

### 4 POPULAR SIZES

- S-4082 8 x 8 x 4"
- S-4122 12 x 12 x 6"
- S-4542 20 x 14 x 6"
- S-4450 24 x 24 x 4"

**ORDER BY 6 PM FOR  
SAME DAY SHIPPING**



S-4898  
18 x 12 x 18"

**LARGER QUANTITIES  
CALL FOR QUOTE**



S-4189  
18 x 12 x 10"

- SOLD IN BUNDLE QUANTITIES
- \* 275 LB. TEST
- 275 LB. TEST DOUBLE WALL (DW)
- SHIPS VIA MOTOR FREIGHT



S-4201  
20 x 20 x 20"

\$3.30 per box any bundle qty.

**IN STOCK. SHIPS  
FROM 13 LOCATIONS.**



S-4364  
20 x 20 x 10"

**LARGER QUANTITIES  
CALL FOR QUOTE**



S-4922  
20 x 8 x 50"

\$9.71 per box any bundle qty.

SOLD IN BUNDLE QUANTITIES  
 \* 275 LB. TEST  
 • 275 LB. TEST DOUBLE WALL (DW)  
 FOL = FULL OVERLAP  
 ■ SHIPS VIA MOTOR FREIGHT

MODEL NO.	INSIDE DIM. L x W x H / VARIABLE DEPTH	PRICE PER BOX					BUNDLE/BALE QTY.	WT./BNDL.	
		25	100	250	500	1,000+			
S-4639	20 x 6 x 6"		\$1.24	\$1.12	\$1.04	\$ .98	\$ .90	25 / 500	15 lbs.
S-23983	20 x 8 x 3"		1.32	1.23	1.17	1.04	.99	25 / 500	15 lbs.
S-18362	20 x 8 x 4"		1.36	1.25	1.18	1.04	1.01	25 / 500	16 lbs.
S-16758	20 x 8 x 6"		1.42	1.32	1.17	1.08	1.04	25 / 375	18 lbs.
S-4499	20 x 8 x 8"	200 LB. TEST	1.00	1.00	1.00	1.00	1.00	25 / 250	21 lbs.
S-22193	20 x 8 x 8"	32 ECT LIGHTWEIGHT	.86	.86	.86	.86	.86	25 / 450	18 lbs.
S-4922*	20 x 8 x 50"	FOL, GUITAR BOX	9.71	9.71	9.71	9.71	9.71	5 / 120	21 lbs.
■S-14225*	20 x 8 x 60"	FOL, KEYBOARD BOX	16.27	14.91	13.83	12.78	12.19	5 / 120	26 lbs.
S-23986	20 x 9 x 9"		1.80	1.63	1.49	1.38	1.25	25 / 300	25 lbs.
S-4840	20 x 10 x 4"		1.40	1.34	1.24	1.11	1.04	25 / 375	20 lbs.
S-4640	20 x 10 x 6"		1.42	1.38	1.29	1.17	1.06	25 / 250	23 lbs.
S-4469	20 x 10 x 8"	200 LB. TEST	1.58	1.49	1.40	1.29	1.23	20 / 200	20 lbs.
S-22650	20 x 10 x 8"	32 ECT LIGHTWEIGHT	1.31	1.25	1.18	1.08	1.04	25 / 300	21 lbs.
S-4458	20 x 10 x 10"	200 LB. TEST	1.94	1.79	1.69	1.52	1.42	25 / 250	27 lbs.
S-21558	20 x 10 x 10"	32 ECT LIGHTWEIGHT	1.62	1.49	1.42	1.28	1.19	25 / 300	24 lbs.
S-23961*	20 x 10 x 10"	275 LB. TEST DW	3.44	3.20	2.99	2.79	2.67	15 / 180	27 lbs.
S-4900	20 x 10 x 12"		2.11	1.97	1.85	1.69	1.60	25 / 250	30 lbs.
S-19079	20 x 12 x 3"		1.75	1.65	1.58	1.42	1.36	25 / 450	23 lbs.
S-4945	20 x 12 x 4"		1.79	1.69	1.60	1.44	1.38	25 / 450	24 lbs.
S-4349	20 x 12 x 6"	200 LB. TEST	1.98	1.84	1.73	1.64	1.44	25 / 250	26 lbs.
S-22194	20 x 12 x 6"	32 ECT LIGHTWEIGHT	1.65	1.57	1.44	1.39	1.22	25 / 300	23 lbs.
S-21539*	20 x 12 x 6"	275 LB. TEST DW	3.32	3.09	2.88	2.69	2.57	15 / 180	26 lbs.
S-22195	20 x 12 x 7"		2.01	1.85	1.75	1.65	1.47	25 / 300	28 lbs.
S-4195	20 x 12 x 8"	200 LB. TEST	2.04	1.88	1.79	1.69	1.50	20 / 240	24 lbs.
S-22587	20 x 12 x 8"	32 ECT LIGHTWEIGHT	1.71	1.59	1.49	1.42	1.26	25 / 300	24 lbs.
S-4203	20 x 12 x 10"	200 LB. TEST	2.26	2.07	1.94	1.79	1.65	20 / 240	26 lbs.
S-23293	20 x 12 x 10"	32 ECT LIGHTWEIGHT	1.90	1.74	1.62	1.49	1.39	25 / 300	27 lbs.
S-4204	20 x 12 x 12"	200 LB. TEST	1.69	1.69	1.69	1.69	1.69	20 / 240	29 lbs.
S-19847	20 x 12 x 12"	32 ECT LIGHTWEIGHT	1.42	1.42	1.42	1.42	1.42	25 / 300	29 lbs.
S-12602	20 x 12 x 12"	12,10,8,6"	2.69	2.51	2.38	2.17	2.05	20 / 240	29 lbs.
S-12603*	20 x 12 x 12"	275 LB. TEST DW	4.59	4.17	3.77	3.46	3.21	15 / 180	35 lbs.
S-19848	20 x 12 x 16"		2.85	2.68	2.53	2.40	2.25	20 / 240	33 lbs.
S-21067	20 x 12 x 20"		3.32	3.11	2.95	2.82	2.64	20 / 140	38 lbs.
S-4567	20 x 13 x 10"		2.40	2.18	2.07	1.92	1.74	25 / 250	34 lbs.
S-23987	20 x 13 x 13"		2.71	2.48	2.34	2.18	1.98	25 / 300	40 lbs.
S-16761	20 x 14 x 3"		1.97	1.84	1.70	1.60	1.50	25 / 300	27 lbs.
S-4994	20 x 14 x 4"		1.98	1.85	1.71	1.61	1.52	25 / 250	28 lbs.
S-25334	20 x 14 x 5"	NEW	2.09	1.96	1.81	1.70	1.61	25 / 250	30 lbs.
S-4542	20 x 14 x 6"	200 LB. TEST	1.56	1.56	1.56	1.56	1.56	25 / 250	31 lbs.
S-21040	20 x 14 x 6"	32 ECT LIGHTWEIGHT	1.31	1.31	1.31	1.31	1.31	25 / 300	27 lbs.
S-22123*	20 x 14 x 6"	275 LB. TEST DW	3.88	3.58	3.35	3.14	3.00	15 / 180	31 lbs.
S-4732	20 x 14 x 8"	200 LB. TEST	2.33	2.17	2.04	1.94	1.73	25 / 250	34 lbs.
S-22196	20 x 14 x 8"	32 ECT LIGHTWEIGHT	1.96	1.81	1.71	1.62	1.44	25 / 300	29 lbs.
S-22582*	20 x 14 x 8"	275 LB. TEST DW	4.18	3.89	3.63	3.41	3.25	15 / 180	33 lbs.
S-4196	20 x 14 x 10"	200 LB. TEST	2.54	2.33	2.18	2.07	1.85	20 / 240	30 lbs.
S-21041	20 x 14 x 10"	32 ECT LIGHTWEIGHT	2.13	1.95	1.85	1.71	1.54	25 / 300	32 lbs.
S-22124*	20 x 14 x 10"	275 LB. TEST DW	4.49	4.18	3.88	3.66	3.52	15 / 180	36 lbs.
S-4206	20 x 14 x 12"	200 LB. TEST	1.94	1.94	1.94	1.94	1.94	20 / 240	33 lbs.
S-20471	20 x 14 x 12"	32 ECT LIGHTWEIGHT	1.62	1.62	1.62	1.62	1.62	25 / 300	34 lbs.
S-19774*	20 x 14 x 12"	275 LB. TEST DW	4.84	4.51	4.18	3.94	3.77	15 / 180	39 lbs.
S-4207	20 x 14 x 14"	200 LB. TEST	3.00	2.75	2.60	2.40	2.18	20 / 240	35 lbs.
S-21042	20 x 14 x 14"	32 ECT LIGHTWEIGHT	2.53	2.32	2.18	2.02	1.85	25 / 300	37 lbs.
S-4641	20 x 14 x 14"	14,12,10,8"	3.56	3.32	3.14	3.00	2.79	15 / 240	25 lbs.
S-18164*	20 x 14 x 14"	275 LB. TEST DW	5.20	4.84	4.50	4.21	4.07	15 / 90	40 lbs.
S-16759	20 x 14 x 16"		3.19	3.00	2.80	2.71	2.51	20 / 140	37 lbs.
S-4901	20 x 14 x 18"		3.41	3.19	3.00	2.90	2.68	20 / 120	40 lbs.
S-21562	20 x 14 x 20"		3.61	3.40	3.19	3.09	2.85	20 / 140	42 lbs.
S-13316	20 x 15 x 6"		2.59	2.40	2.26	2.10	1.98	25 / 250	32 lbs.
S-23988	20 x 15 x 8"		2.64	2.46	2.29	2.16	2.02	25 / 300	36 lbs.
S-15038	20 x 15 x 9"		2.67	2.49	2.32	2.18	2.05	25 / 300	37 lbs.
S-11378	20 x 15 x 10"		2.69	2.51	2.36	2.26	2.10	20 / 240	32 lbs.
S-4926	20 x 15 x 12"		2.90	2.67	2.50	2.32	2.17	25 / 250	42 lbs.
S-4642	20 x 15 x 15"	200 LB. TEST	2.36	2.36	2.36	2.36	2.36	20 / 240	40 lbs.
S-21559	20 x 15 x 15"	32 ECT LIGHTWEIGHT	1.97	1.97	1.97	1.97	1.97	25 / 300	40 lbs.

MODEL NO.	INSIDE DIM. L x W x H /	VARIABLE DEPTH	PRICE PER BOX					BUNDLE/BALE QTY.	WT./BNDL.
			25	100	250	500	1,000+		
S-4821	20 x 16 x 4"		\$2.53	\$2.36	\$2.18	\$2.05	\$1.94	25 / 250	33 lbs.
S-4902	20 x 16 x 6"	200 LB. TEST	2.61	2.44	2.30	2.14	2.02	25 / 250	36 lbs.
S-22651	20 x 16 x 6"	32 ECT LIGHTWEIGHT	2.20	2.06	1.94	1.80	1.70	25 / 300	30 lbs.
S-4643	20 x 16 x 8"	200 LB. TEST	2.69	2.53	2.36	2.18	2.07	25 / 250	39 lbs.
S-21547	20 x 16 x 8"	32 ECT LIGHTWEIGHT	2.26	2.11	1.97	1.84	1.73	25 / 300	33 lbs.
S-23962*	20 x 16 x 8"	275 LB. TEST DW	4.74	4.43	4.10	3.86	3.71	15 / 180	38 lbs.
S-22197	20 x 16 x 9"		2.76	2.60	2.42	2.32	2.20	25 / 300	41 lbs.
S-4644	20 x 16 x 10"	200 LB. TEST	2.82	2.68	2.50	2.43	2.33	20 / 240	34 lbs.
S-22198	20 x 16 x 10"	32 ECT LIGHTWEIGHT	2.38	2.25	2.10	2.05	1.96	25 / 300	36 lbs.
S-21043*	20 x 16 x 10"	275 LB. TEST DW	5.12	4.76	4.47	4.16	4.00	15 / 180	41 lbs.
S-4339	20 x 16 x 12"	200 LB. TEST	2.99	2.73	2.59	2.49	2.36	25 / 250	45 lbs.
S-21560	20 x 16 x 12"	32 ECT LIGHTWEIGHT	2.51	2.30	2.18	2.08	1.97	25 / 300	39 lbs.
S-21540*	20 x 16 x 12"	275 LB. TEST DW	5.50	5.12	4.79	4.47	4.32	15 / 90	44 lbs.
S-4200	20 x 16 x 14"	200 LB. TEST	2.36	2.36	2.36	2.36	2.36	20 / 240	40 lbs.
S-18357	20 x 16 x 14"	32 ECT LIGHTWEIGHT	1.96	1.96	1.96	1.96	1.96	25 / 300	40 lbs.
S-4861	20 x 16 x 14"	14,12,10,8"	2.67	2.67	2.67	2.67	2.67	20 / 240	40 lbs.
S-4794*	20 x 16 x 14"	275 LB. TEST	4.38	4.09	3.79	3.55	3.43	15 / 120	36 lbs.
S-13317*	20 x 16 x 14"	275 LB. TEST DW	5.88	5.49	5.10	4.79	4.60	15 / 90	45 lbs.
S-4645	20 x 16 x 16"	200 LB. TEST	3.58	3.43	3.22	3.13	2.91	15 / 150	31 lbs.
S-21044	20 x 16 x 16"	32 ECT LIGHTWEIGHT	3.00	2.89	2.72	2.60	2.43	25 / 150	44 lbs.
S-4995*	20 x 16 x 16"	275 LB. TEST DW	6.25	5.84	5.43	5.10	4.91	10 / 90	32 lbs.
S-22652	20 x 16 x 18"		3.82	3.64	3.42	3.32	3.10	20 / 140	45 lbs.
S-23993	20 x 16 x 20"		4.04	3.84	3.61	3.52	3.26	20 / 140	47 lbs.
S-19093	20 x 18 x 4"		2.57	2.40	2.26	2.11	2.01	25 / 250	39 lbs.
S-4903	20 x 18 x 6"		2.67	2.51	2.36	2.18	2.10	25 / 250	41 lbs.
S-22199	20 x 18 x 8"		2.96	2.78	2.60	2.43	2.30	25 / 300	45 lbs.
S-12604	20 x 18 x 10"		3.25	3.03	2.85	2.68	2.50	20 / 240	37 lbs.
S-4227	20 x 18 x 12"	2 1/2 CU. FT.	3.52	3.30	3.03	2.88	2.67	10 / 150	21 lbs.
S-19841	20 x 18 x 14"		3.82	3.56	3.34	3.17	2.96	15 / 150	33 lbs.
S-4795	20 x 18 x 16"		4.05	3.77	3.54	3.34	3.11	10 / 150	24 lbs.
S-14286	20 x 18 x 18"		4.20	3.94	3.71	3.53	3.22	15 / 150	36 lbs.
S-4646	20 x 18 x 22"		4.72	4.39	4.07	3.83	3.52	10 / 120	27 lbs.
S-4647	20 x 20 x 2"		2.98	2.76	2.68	2.48	2.36	20 / 240	33 lbs.
S-23994	20 x 20 x 3"		3.00	2.78	2.71	2.50	2.38	25 / 300	42 lbs.
S-4301	20 x 20 x 4"	200 LB. GARMENT BOX	2.26	2.26	2.26	2.26	2.26	10 / 240	18 lbs.
S-22588	20 x 20 x 4"	32 ECT LIGHTWEIGHT	1.89	1.89	1.89	1.89	1.89	25 / 300	36 lbs.
S-4500	20 x 20 x 6"	200 LB. TEST	2.28	2.28	2.28	2.28	2.28	15 / 240	28 lbs.
S-20472	20 x 20 x 6"	32 ECT LIGHTWEIGHT	1.92	1.92	1.92	1.92	1.92	25 / 300	39 lbs.
S-22583*	20 x 20 x 6"	275 LB. TEST DW	5.67	5.30	4.91	4.56	4.28	15 / 180	46 lbs.
S-19094	20 x 20 x 7"		3.10	2.91	2.73	2.59	2.44	15 / 150	30 lbs.
S-4470	20 x 20 x 8"	200 LB. TEST	3.13	2.95	2.76	2.61	2.49	15 / 150	31 lbs.
S-22200	20 x 20 x 8"	32 ECT LIGHTWEIGHT	2.62	2.49	2.32	2.20	2.08	25 / 150	43 lbs.
S-21045*	20 x 20 x 8"	275 LB. TEST DW	6.10	5.70	5.26	4.90	4.61	10 / 90	33 lbs.
S-4364	20 x 20 x 10"	200 LB. TEST	3.21	3.03	2.90	2.69	2.60	15 / 150	32 lbs.
S-21046	20 x 20 x 10"	32 ECT LIGHTWEIGHT	2.71	2.55	2.40	2.25	2.18	25 / 150	46 lbs.
S-18165*	20 x 20 x 10"	275 LB. TEST DW	6.54	6.09	5.64	5.23	4.93	10 / 90	33 lbs.
S-14287	20 x 20 x 11"		3.35	3.14	3.00	2.79	2.69	15 / 150	33 lbs.
S-4210	20 x 20 x 12"	200 LB. TEST	2.58	2.58	2.58	2.58	2.58	15 / 120	34 lbs.
S-18358	20 x 20 x 12"	32 ECT LIGHTWEIGHT	2.20	2.20	2.20	2.20	2.20	20 / 140	38 lbs.
S-4543	20 x 20 x 12"	12,10,8,6"	4.32	4.05	3.86	3.69	3.32	15 / 120	34 lbs.
S-4996*	20 x 20 x 12"	275 LB. TEST DW	6.97	6.30	5.93	5.46	5.16	10 / 90	36 lbs.
S-4350	20 x 20 x 14"	200 LB. TEST	4.22	4.01	3.83	3.67	3.30	25 / 150	61 lbs.
S-22653	20 x 20 x 14"	32 ECT LIGHTWEIGHT	3.55	3.36	3.21	3.09	2.76	20 / 140	40 lbs.
S-4862	20 x 20 x 15"		4.36	4.07	3.86	3.69	3.32	20 / 120	50 lbs.
S-4568	20 x 20 x 16"		4.47	4.14	3.87	3.71	3.32	20 / 120	51 lbs.
S-13318*	20 x 20 x 16"	275 LB. TEST DW	7.82	7.23	6.74	6.30	6.12	10 / 90	40 lbs.
S-4158	20 x 20 x 18"	4.2 CU. FT.	4.49	4.16	3.89	3.72	3.34	10 / 120	28 lbs.
S-4201	20 x 20 x 20"	200 LB. TEST	3.30	3.30	3.30	3.30	3.30	10 / 120	29 lbs.
S-18359	20 x 20 x 20"	32 ECT LIGHTWEIGHT	2.76	2.76	2.76	2.76	2.76	10 / 150	24 lbs.
S-11247	20 x 20 x 20"	20,18,16,14,12"	5.26	4.84	4.51	4.21	3.87	10 / 120	29 lbs.
S-4372	20 x 20 x 20"	20,10,8,6"	5.26	4.84	4.51	4.21	3.87	10 / 120	29 lbs.
S-4934	20 x 20 x 20"	WHITE	5.46	5.07	4.83	4.49	4.14	10 / 120	29 lbs.
S-4697*	20 x 20 x 20"	275 LB. TEST	6.12	5.72	5.39	5.03	4.79	10 / 120	42 lbs.
S-18983*	20 x 20 x 20"	20,18,16,14,12,10* 275 LB. TEST	6.25	5.91	5.54	5.20	4.80	10 / 120	42 lbs.



S-4646  
20 x 18 x 22"

**ORDER BY 6 PM FOR  
SAME DAY SHIPPING**



S-4207  
20 x 14 x 14"

**OVER 1,700 BOX SIZES  
ALWAYS IN STOCK**



S-14286  
20 x 18 x 18"

SOLD IN BUNDLE QUANTITIES  
\* 275 LB. TEST  
• 275 LB. TEST DOUBLE WALL (DW)





S-4552  
24 x 5 x 18"  
FOL SIDE LOADER

\$1.86 per box any bundle qty.

OVER 1,700 BOX SIZES  
ALWAYS IN STOCK



S-19850  
22 x 12 x 6"

SEE RED AND SAVE  
ON POPULAR SIZES !



S-4841  
22 x 16 x 16"

MODEL NO.	INSIDE DIM. L x W x H	VARIABLE DEPTH	PRICE PER BOX					BUNDLE/BALE QTY.	WT./BNDL.
			25	100	250	500	1,000+		
■S-4733	20 x 20 x 20"	275 LB. TEST DW	\$6.12	\$6.12	\$6.12	\$6.12	\$6.12	10 / 90	45 lbs.
■S-18918	20 x 20 x 20"	500 LB. TEST DW	19.35	18.17	17.11	16.06	15.02	10 / 70	71 lbs.
■S-11379	20 x 20 x 24"		5.20	4.84	4.50	4.20	3.83	10 / 120	31 lbs.
■S-21533	20 x 20 x 24"	275 LB. TEST DW	9.51	8.81	8.19	7.66	7.44	10 / 90	51 lbs.
■S-4544	20 x 20 x 25"	MAX. POSTAL SIZE	5.32	4.92	4.60	4.32	3.89	10 / 120	33 lbs.
■S-4212	20 x 20 x 26"		5.54	5.13	4.83	4.48	4.05	10 / 120	34 lbs.
■S-16740	20 x 20 x 28"		5.84	5.40	5.07	4.70	4.26	10 / 140	35 lbs.
■S-20494	20 x 20 x 30"		6.08	5.64	5.28	4.91	4.45	10 / 150	36 lbs.
■S-4569	20 x 20 x 36"		6.94	6.56	5.66	5.43	4.84	10 / 120	39 lbs.
■S-19048	20 x 20 x 40"		7.73	7.40	6.44	6.13	5.54	10 / 150	44 lbs.
■S-11250	20 x 20 x 40 - 74"	TELESCOPIC	14.87	13.98	13.21	12.28	11.39	10 / 120	77 lbs.
■S-4822	20 x 20 x 48"		8.44	8.03	6.98	6.66	6.07	10 / 120	47 lbs.
S-4314	21 x 10 x 10"		2.07	1.81	1.65	1.50	1.39	25 / 250	28 lbs.
S-4648	21 x 12 x 12"		2.61	2.40	2.26	2.10	1.92	20 / 240	25 lbs.
S-19049	21 x 13 x 13"		2.92	2.69	2.54	2.38	2.17	20 / 240	33 lbs.
S-11380	21 x 14 x 10"		2.75	2.51	2.32	2.14	1.98	20 / 240	30 lbs.
S-4365	21 x 14 x 14"		3.13	2.99	2.79	2.64	2.44	20 / 120	35 lbs.
S-16741	21 x 15 x 15"		3.30	3.03	2.92	2.69	2.50	20 / 140	39 lbs.
■S-14288	21 x 21 x 21"		5.24	4.84	4.51	4.21	3.87	15 / 150	46 lbs.
S-15962	21 3/8 x 15 5/8 x 6 3/8"	GARMENT BOX	2.75	2.59	2.40	2.29	2.10	25 / 250	35 lbs.
S-15963	21 3/8 x 15 5/8 x 9 1/2"	GARMENT BOX	2.98	2.75	2.60	2.40	2.29	20 / 240	33 lbs.
S-15964	21 3/8 x 15 5/8 x 12 5/8"	GARMENT BOX	3.34	3.10	2.95	2.73	2.54	20 / 140	36 lbs.
S-4937	22 x 6 x 6"		1.34	1.23	1.06	1.04	.94	25 / 500	19 lbs.
S-22654	22 x 8 x 8"		1.64	1.49	1.34	1.23	1.16	25 / 450	23 lbs.
S-4649	22 x 10 x 4"		1.39	1.25	1.08	1.04	.98	25 / 250	20 lbs.
S-13319	22 x 10 x 6"		1.73	1.52	1.42	1.28	1.17	25 / 375	23 lbs.
S-4650	22 x 10 x 9"		2.07	1.81	1.65	1.50	1.39	20 / 240	22 lbs.
S-25346	22 x 10 x 10"	NEW	2.18	1.91	1.74	1.58	1.46	25 / 250	30 lbs.
S-24069	22 x 12 x 4"		1.85	1.75	1.64	1.53	1.42	25 / 450	26 lbs.
S-19850	22 x 12 x 6"		2.08	1.96	1.84	1.71	1.60	25 / 300	29 lbs.
S-21050	22 x 12 x 8"		2.22	2.08	1.96	1.85	1.73	25 / 300	32 lbs.
S-4863	22 x 12 x 10"		2.36	2.18	2.07	1.96	1.84	20 / 240	27 lbs.
S-4159	22 x 12 x 12"		2.54	2.40	2.26	2.11	1.98	20 / 240	29 lbs.
S-24072	22 x 13 x 8"		2.38	2.22	2.07	1.97	1.84	25 / 300	34 lbs.
S-20496	22 x 14 x 4"		2.18	2.07	1.94	1.83	1.69	25 / 300	30 lbs.
S-4796	22 x 14 x 6"		2.44	2.30	2.14	2.02	1.88	20 / 240	26 lbs.
S-12605	22 x 14 x 8"		2.53	2.36	2.18	2.07	1.96	20 / 240	28 lbs.
S-13320	22 x 14 x 10"		2.61	2.43	2.30	2.14	2.01	20 / 240	30 lbs.
S-4221	22 x 14 x 12"	200 LB. TEST	1.92	1.92	1.92	1.92	1.92	20 / 240	34 lbs.
S-19851	22 x 14 x 12"	32 ECT LIGHTWEIGHT	1.60	1.60	1.60	1.60	1.60	25 / 300	35 lbs.
S-18166	22 x 14 x 12"	275 LB. TEST DW	5.16	4.79	4.47	4.16	4.01	15 / 90	39 lbs.
S-4734	22 x 14 x 14"		3.11	2.85	2.73	2.50	2.33	20 / 240	38 lbs.
S-22207	22 x 15 x 10"		2.85	2.62	2.50	2.30	2.17	25 / 300	43 lbs.
S-24073	22 x 15 x 12"		3.07	2.83	2.69	2.49	2.33	25 / 150	46 lbs.
S-13321	22 x 15 x 15"		3.34	3.13	2.99	2.73	2.54	20 / 140	39 lbs.
S-22584	22 x 15 x 15"	275 LB. TEST DW	6.09	5.62	5.25	4.91	4.73	15 / 90	49 lbs.
S-21047	22 x 16 x 4"		2.57	2.39	2.26	2.13	1.95	25 / 300	35 lbs.
S-20497	22 x 16 x 6"		2.64	2.48	2.33	2.16	1.97	25 / 300	39 lbs.
S-18361	22 x 16 x 8"		2.76	2.57	2.43	2.25	2.08	20 / 240	33 lbs.
S-13322	22 x 16 x 10"		3.09	2.80	2.69	2.44	2.30	20 / 240	35 lbs.
S-18363	22 x 16 x 12"		3.21	2.99	2.82	2.60	2.43	20 / 140	39 lbs.
S-19050	22 x 16 x 14"		3.36	3.14	2.98	2.75	2.57	20 / 140	42 lbs.
S-4841	22 x 16 x 16"	200 LB. TEST	3.53	3.32	3.11	2.91	2.69	15 / 120	34 lbs.
S-21549	22 x 16 x 16"	32 ECT LIGHTWEIGHT	2.96	2.77	2.59	2.43	2.26	20 / 140	37 lbs.
S-4471	22 x 17 x 12"	200 LB. TEST	2.31	2.31	2.31	2.31	2.31	10 / 120	20 lbs.
S-21550	22 x 17 x 12"	32 ECT LIGHTWEIGHT	1.94	1.94	1.94	1.94	1.94	25 / 150	43 lbs.
S-21048	22 x 18 x 4"		2.61	2.49	2.33	2.21	2.07	25 / 300	41 lbs.
S-4735	22 x 18 x 6"		2.68	2.53	2.38	2.26	2.11	20 / 240	35 lbs.
S-15039	22 x 18 x 8"		2.96	2.76	2.64	2.50	2.38	20 / 140	37 lbs.
S-18364	22 x 18 x 10"		3.30	3.09	2.88	2.69	2.51	20 / 140	41 lbs.
S-4997	22 x 18 x 12"		3.52	3.32	3.09	2.90	2.68	15 / 120	34 lbs.
S-24074	22 x 18 x 14"		3.86	3.63	3.40	3.21	3.01	20 / 140	47 lbs.
S-4797	22 x 18 x 16"	200 LB. TEST	4.06	3.79	3.55	3.35	3.12	15 / 120	37 lbs.
S-21049	22 x 18 x 16"	32 ECT LIGHTWEIGHT	3.40	3.17	2.98	2.80	2.60	20 / 140	42 lbs.

SOLD IN BUNDLE QUANTITIES

• 275 LB. TEST DOUBLE WALL (DW)

■ SHIPS VIA MOTOR FREIGHT

MODEL NO.	INSIDE DIM. L x W x H	VARIABLE DEPTH	PRICE PER BOX					BUNDLE/BALE QTY.	WT./BNDL.
			25	100	250	500	1,000+		
S-16458	22 x 18 x 16"	275 LB. TEST DW	\$7.40	\$6.87	\$6.35	\$5.95	\$5.79	10 / 90	39 lbs.
S-20495	22 x 18 x 18"		4.41	4.14	3.89	3.66	3.41	15 / 150	39 lbs.
S-23335	22 x 20 x 6"		3.32	3.07	2.83	2.65	2.50	20 / 240	40 lbs.
S-15040	22 x 20 x 10"		3.66	3.36	3.14	2.96	2.75	15 / 150	33 lbs.
S-16742	22 x 20 x 14"		4.36	4.07	3.86	3.63	3.33	15 / 150	39 lbs.
S-19051	22 x 20 x 20"		4.80	4.47	4.17	3.83	3.63	15 / 150	46 lbs.
S-12606	22 x 22 x 4"		3.35	3.09	2.82	2.67	2.49	10 / 240	20 lbs.
S-4413	22 x 22 x 6"		3.58	3.32	3.03	2.85	2.67	15 / 120	33 lbs.
S-4651	22 x 22 x 8"		3.74	3.41	3.21	2.99	2.80	15 / 120	35 lbs.
S-4763	22 x 22 x 10"		4.14	3.75	3.54	3.21	3.02	15 / 120	38 lbs.
S-4736	22 x 22 x 12"	200 LB. TEST	4.32	3.98	3.71	3.49	3.22	10 / 120	26 lbs.
S-21551	22 x 22 x 12"	32 ECT LIGHTWEIGHT	3.63	3.34	3.12	2.92	2.72	20 / 140	46 lbs.
S-20411	22 x 22 x 12"	275 LB. TEST DW	8.15	7.37	6.94	6.36	6.05	10 / 90	43 lbs.
S-14289	22 x 22 x 14"		4.47	4.14	3.86	3.56	3.35	15 / 150	42 lbs.
S-4501	22 x 22 x 16"		4.63	4.34	4.05	3.75	3.54	10 / 120	30 lbs.
S-22116	22 x 22 x 16"	275 LB. TEST DW	9.09	8.23	7.73	7.10	6.74	10 / 90	48 lbs.
S-12607	22 x 22 x 18"		4.93	4.63	4.34	4.01	3.74	10 / 150	31 lbs.
S-4826	22 x 22 x 20"		5.26	4.91	4.59	4.21	3.98	10 / 120	33 lbs.
S-4319	22 x 22 x 22"	200 LB. 6 CU. FT.	3.93	3.93	3.93	3.93	3.93	10 / 120	34 lbs.
S-20473	22 x 22 x 22"	32 ECT LIGHTWEIGHT	3.30	3.30	3.30	3.30	3.30	15 / 150	43 lbs.
S-4447	22 x 22 x 22"	22,20,18,16"	6.24	5.77	5.50	5.12	4.83	10 / 120	34 lbs.
S-4798	22 x 22 x 22"	275 LB. TEST DW	9.74	9.09	8.64	8.07	7.60	10 / 90	53 lbs.
S-21561	22 x 22 x 24"		6.52	6.05	5.73	5.35	5.03	10 / 140	37 lbs.
S-13323	22 x 22 x 30"		7.11	6.76	6.37	6.16	5.71	10 / 120	39 lbs.
S-4652	22 x 22 x 36"		7.72	7.32	6.93	6.56	6.16	10 / 120	45 lbs.
S-22172	22 x 22 x 40 - 74"	TELESCOPIC	17.25	16.40	15.60	14.79	14.03	10 / 120	80 lbs.
S-4213	23 x 16 x 18 5/8"		3.99	3.67	3.43	3.19	3.02	15 / 120	37 lbs.
S-4231	23 x 17 x 12"		3.30	3.09	2.85	2.68	2.54	10 / 120	21 lbs.
S-20542	23 x 23 x 23"		6.20	5.77	5.43	5.03	4.70	10 / 150	38 lbs.
S-4472	24 x 4 x 4"		1.12	1.04	.98	.94	.84	25 / 500	11 lbs.
S-4552	24 x 5 x 18"	FOL	1.86	1.86	1.86	1.86	1.86	25 / 250	36 lbs.
S-4998	24 x 5 x 24"	FOL	3.30	3.02	2.79	2.61	2.49	10 / 140	18 lbs.
S-14290	24 x 6 x 4"		1.34	1.18	1.11	1.04	.94	25 / 500	14 lbs.
S-4240	24 x 6 x 6"	200 LB. TEST	.91	.91	.91	.91	.91	25 / 500	17 lbs.
S-19871	24 x 6 x 6"	32 ECT LIGHTWEIGHT	.77	.77	.77	.77	.77	25 / 600	14 lbs.
S-18924	24 x 6 x 6"	275 LB. TEST DW	2.69	2.50	2.33	2.18	2.04	15 / 360	17 lbs.
S-4904	24 x 6 x 8"		1.40	1.34	1.24	1.11	1.04	25 / 375	20 lbs.
S-18319*	24 x 6 x 18"	FOL, 275 LB. TEST	5.61	5.07	4.58	4.20	3.93	10 / 140	23 lbs.
S-20535	24 x 8 x 4"		1.46	1.38	1.28	1.17	1.06	25 / 500	18 lbs.
S-12608	24 x 8 x 6"		1.49	1.39	1.29	1.18	1.08	25 / 375	20 lbs.
S-4502	24 x 8 x 8"	200 LB. TEST	1.73	1.58	1.44	1.39	1.25	25 / 375	24 lbs.
S-21028	24 x 8 x 8"	32 ECT LIGHTWEIGHT	1.46	1.32	1.22	1.15	1.05	25 / 450	20 lbs.
S-14259	24 x 8 x 57 - 108"	TELESCOPIC, FOL SURFBOARD	40.00	39.00	37.00	34.00	32.00	5 / 75	38 lbs.
S-4737	24 x 9 x 6"		1.69	1.49	1.38	1.25	1.18	25 / 250	24 lbs.
S-11381	24 x 9 x 9"		1.81	1.65	1.57	1.42	1.38	25 / 250	27 lbs.
S-12609	24 x 10 x 4"		1.63	1.44	1.36	1.24	1.17	25 / 250	22 lbs.
S-4842	24 x 10 x 6"		1.74	1.61	1.49	1.39	1.34	25 / 250	25 lbs.
S-4545	24 x 10 x 8"		1.95	1.81	1.69	1.58	1.49	25 / 250	28 lbs.
S-4414	24 x 10 x 10"	200 LB. TEST	2.07	1.96	1.84	1.64	1.58	25 / 250	32 lbs.
S-23332	24 x 10 x 10"	32 ECT LIGHTWEIGHT	1.74	1.64	1.54	1.39	1.31	25 / 300	26 lbs.
S-23294	24 x 10 x 10"	275 LB. TEST DW	3.82	3.44	3.25	2.98	2.82	15 / 180	31 lbs.
S-19052	24 x 10 x 12"		2.33	2.21	2.11	1.94	1.70	25 / 250	35 lbs.
S-23333	24 x 12 x 3"		1.91	1.70	1.60	1.48	1.38	25 / 375	25 lbs.
S-13324	24 x 12 x 4"		1.92	1.71	1.61	1.49	1.39	25 / 375	26 lbs.
S-22664	24 x 12 x 5"		1.95	1.76	1.63	1.50	1.40	25 / 450	29 lbs.
S-4415	24 x 12 x 6"	200 LB. TEST	1.97	1.81	1.65	1.52	1.42	20 / 240	24 lbs.
S-21548	24 x 12 x 6"	32 ECT LIGHTWEIGHT	1.64	1.52	1.40	1.28	1.18	25 / 300	25 lbs.
S-4473	24 x 12 x 6"	6,4,2"	2.33	2.17	2.04	1.88	1.73	20 / 240	24 lbs.
S-4653	24 x 12 x 8"	200 LB. TEST	2.40	2.29	2.14	1.96	1.79	25 / 250	32 lbs.
S-21553	24 x 12 x 8"	32 ECT LIGHTWEIGHT	2.04	1.92	1.81	1.63	1.49	25 / 300	28 lbs.
S-21029	24 x 12 x 8"	275 LB. TEST DW	4.39	4.09	3.79	3.45	3.13	15 / 180	32 lbs.
S-4570	24 x 12 x 10"		2.50	2.30	2.20	2.10	1.95	25 / 250	36 lbs.
S-4243	24 x 12 x 12"	200 LB. TEST	1.84	1.84	1.84	1.84	1.84	20 / 240	32 lbs.
S-18360	24 x 12 x 12"	32 ECT LIGHTWEIGHT	1.51	1.51	1.51	1.51	1.51	25 / 300	32 lbs.



## ROLLING TOOL SEAT

### FREE OFFER

Free upon request with any Uline order of \$750 or more.

**ORDER BY 6 PM FOR SAME DAY SHIPPING**



S-4240  
24 x 6 x 6"

\$.91 per box any bundle qty.

**LARGER QUANTITIES CALL FOR QUOTE**



S-4159  
22 x 12 x 12"

SOLD IN BUNDLE QUANTITIES  
 \* 275 LB. TEST  
 • 275 LB. TEST DOUBLE WALL (DW)  
 FOL = FULL OVERLAP  
 ■ SHIPS VIA MOTOR FREIGHT



S-14233  
24 x 24 x 36"  
275 LB. TEST DW

**OVER 1,700 BOX SIZES  
ALWAYS IN STOCK**



S-4505  
24 x 24 x 6"

**ORDER BY 6 PM FOR  
SAME DAY SHIPPING**



S-4750  
24 x 20 x 46"  
WARDROBE 51 ECT DW

**MOVING BOXES,  
PAGES 62-69**

MODEL NO.	INSIDE DIM. L x W x H	VARIABLE DEPTH	PRICE PER BOX					BUNDLE/BALE QTY.	WT./BNDL.
			25	100	250	500	1,000+		
S-367	24 x 12 x 12"	12,10,8,6"	\$2.80	\$2.67	\$2.49	\$2.40	\$2.32	25 / 250	40 lbs.
S-4764	24 x 12 x 12"	WHITE	3.14	2.96	2.80	2.64	2.44	25 / 250	40 lbs.
S-4772*	24 x 12 x 12"	275 LB. TEST	3.32	3.19	3.02	2.95	2.68	25 / 250	56 lbs.
S-4843*	24 x 12 x 12"	275 LB. TEST DW	3.25	3.25	3.25	3.25	3.25	15 / 180	37 lbs.
S-19053	24 x 12 x 16"		3.42	3.11	2.99	2.88	2.69	25 / 125	46 lbs.
S-19872	24 x 12 x 18"		3.55	3.21	3.11	2.98	2.77	20 / 140	40 lbs.
S-4114	24 x 12 x 24"	4 CU. FT.	4.56	4.16	4.00	3.72	3.49	10 / 120	23 lbs.
S-12610	24 x 13 x 31"	31,26" SUITCASE BOX	4.98	4.68	4.38	4.09	3.87	10 / 150	29 lbs.
S-4546	24 x 14 x 4"		2.17	1.98	1.88	1.74	1.65	25 / 250	31 lbs.
S-4905	24 x 14 x 6"		2.49	2.29	2.14	2.02	1.88	25 / 250	35 lbs.
S-4503	24 x 14 x 8"	200 LB. TEST	2.73	2.54	2.38	2.18	2.10	20 / 240	30 lbs.
S-22665	24 x 14 x 8"	32 ECT LIGHTWEIGHT	2.29	2.13	1.99	1.84	1.76	25 / 300	31 lbs.
S-4738	24 x 14 x 10"	200 LB. TEST	2.90	2.69	2.53	2.32	2.16	20 / 240	33 lbs.
S-23334	24 x 14 x 10"	32 ECT LIGHTWEIGHT	2.43	2.27	2.13	1.95	1.81	25 / 300	34 lbs.
S-4217	24 x 14 x 12"	200 LB. TEST	3.03	2.80	2.67	2.44	2.26	20 / 240	36 lbs.
S-21030	24 x 14 x 12"	32 ECT LIGHTWEIGHT	2.55	2.36	2.22	2.05	1.91	25 / 300	38 lbs.
S-4654	24 x 14 x 14"	200 LB. TEST	2.53	2.53	2.53	2.53	2.53	15 / 150	31 lbs.
S-21554	24 x 14 x 14"	32 ECT LIGHTWEIGHT	2.11	2.11	2.11	2.11	2.11	25 / 150	41 lbs.
S-16459*	24 x 14 x 14"	275 LB. TEST DW	5.86	5.28	5.02	4.58	4.34	10 / 90	30 lbs.
S-22666	24 x 14 x 16"		3.68	3.41	3.17	2.96	2.78	20 / 140	42 lbs.
S-4655	24 x 14 x 18"		3.93	3.63	3.36	3.14	2.90	10 / 120	24 lbs.
S-19816	24 x 14 x 20"		4.15	3.86	3.57	3.34	3.03	15 / 150	36 lbs.
S-4957	24 x 15 x 10"	FILE BOX	3.00	2.80	2.70	2.50	2.30	15 / 240	29 lbs.
S-16755	24 x 15 x 12"		3.30	3.03	2.91	2.68	2.53	20 / 140	38 lbs.
S-14277	24 x 15 x 15"		3.56	3.32	3.14	2.96	2.73	20 / 140	41 lbs.
S-4547	24 x 16 x 4"		2.21	2.04	1.96	1.79	1.71	25 / 250	36 lbs.
S-4504	24 x 16 x 6"	200 LB. TEST	2.76	2.59	2.49	2.26	2.14	20 / 240	32 lbs.
S-22208	24 x 16 x 6"	32 ECT LIGHTWEIGHT	2.32	2.18	2.08	1.91	1.80	25 / 300	34 lbs.
S-4799	24 x 16 x 8"		2.36	2.36	2.36	2.36	2.36	20 / 240	33 lbs.
S-18925*	24 x 16 x 8"	275 LB. TEST DW	5.56	5.19	4.83	4.51	4.21	15 / 180	42 lbs.
S-4800	24 x 16 x 10"		3.19	2.98	2.90	2.68	2.53	15 / 240	30 lbs.
S-4162	24 x 16 x 12"	200 LB. TEST	2.53	2.53	2.53	2.53	2.53	15 / 150	31 lbs.
S-20474	24 x 16 x 12"	32 ECT LIGHTWEIGHT	2.11	2.11	2.11	2.11	2.11	25 / 150	42 lbs.
S-4765	24 x 16 x 12"	12,10,8,6"	2.70	2.70	2.70	2.70	2.70	15 / 150	31 lbs.
S-20412*	24 x 16 x 12"	275 LB. TEST DW	6.35	5.82	5.46	5.07	4.76	10 / 90	33 lbs.
S-19817	24 x 16 x 13"		3.56	3.30	3.14	2.98	2.72	15 / 150	32 lbs.
S-4656	24 x 16 x 14"		3.66	3.36	3.21	3.02	2.76	15 / 150	33 lbs.
S-4218	24 x 16 x 16"	200 LB. TEST	2.75	2.75	2.75	2.75	2.75	10 / 120	24 lbs.
S-21031	24 x 16 x 16"	32 ECT LIGHTWEIGHT	2.28	2.28	2.28	2.28	2.28	20 / 140	39 lbs.
S-15041*	24 x 16 x 16"	275 LB. TEST DW	6.98	6.31	5.97	5.49	5.18	10 / 90	36 lbs.
S-19054	24 x 16 x 18"		4.22	3.93	3.66	3.41	3.13	15 / 150	37 lbs.
S-22655	24 x 16 x 20"		4.55	4.21	3.94	3.66	3.36	15 / 150	39 lbs.
S-4999	24 x 16 x 24"		5.18	4.80	4.49	4.18	3.87	10 / 150	30 lbs.
S-16762	24 x 17 x 3"		2.96	2.76	2.59	2.39	2.18	25 / 300	38 lbs.
S-16756	24 x 17 x 12"		3.63	3.34	3.19	3.00	2.73	15 / 150	32 lbs.
S-4657	24 x 17 x 15"		3.98	3.66	3.41	3.19	2.91	15 / 150	35 lbs.
S-23991	24 x 18 x 3"		2.99	2.77	2.59	2.39	2.14	25 / 300	41 lbs.
S-4827	24 x 18 x 4"		2.04	2.04	2.04	2.04	2.04	20 / 240	34 lbs.
S-4416	24 x 18 x 6"	200 LB. TEST	2.85	2.61	2.53	2.29	2.17	20 / 240	37 lbs.
S-21555	24 x 18 x 6"	32 ECT LIGHTWEIGHT	2.38	2.18	2.11	1.92	1.83	25 / 300	39 lbs.
S-21032*	24 x 18 x 6"	275 LB. TEST DW	5.54	5.01	4.70	4.34	4.09	15 / 180	44 lbs.
S-10655	24 x 18 x 8"		3.32	3.03	2.91	2.67	2.49	20 / 240	40 lbs.
S-4658	24 x 18 x 10"		3.67	3.34	3.10	2.91	2.75	10 / 120	21 lbs.
S-23963*	24 x 18 x 10"	275 LB. TEST DW	6.54	5.91	5.61	5.13	4.90	10 / 90	34 lbs.
S-4219	24 x 18 x 12"	200 LB. 3 CU. FT.	2.70	2.70	2.70	2.70	2.70	10 / 120	23 lbs.
S-19818	24 x 18 x 12"	32 ECT LIGHTWEIGHT	2.26	2.26	2.26	2.26	2.26	20 / 140	38 lbs.
S-4802	24 x 18 x 12"	12,10,8,6"	4.21	3.93	3.69	3.49	3.19	10 / 120	23 lbs.
S-4801*	24 x 18 x 12"	275 LB. TEST	4.67	4.48	4.20	4.04	3.79	15 / 120	45 lbs.
S-11255*	24 x 18 x 12"	275 LB. TEST DW	6.88	6.18	5.86	5.36	5.07	10 / 90	35 lbs.
S-4906	24 x 18 x 14"		4.20	3.88	3.63	3.41	3.13	15 / 120	36 lbs.
S-23992	24 x 18 x 15"		4.34	4.00	3.74	3.52	3.23	15 / 150	37 lbs.
S-4698	24 x 18 x 16"	200 LB. TEST	4.48	4.14	3.86	3.63	3.32	15 / 120	38 lbs.
S-23330	24 x 18 x 16"	32 ECT LIGHTWEIGHT	3.76	3.47	3.23	3.03	2.79	20 / 140	42 lbs.
S-4340	24 x 18 x 18"	200 LB. 4 1/2 CU. FT.	3.39	3.39	3.39	3.39	3.39	15 / 120	40 lbs.

SOLD IN BUNDLE QUANTITIES

\* 275 LB. TEST

• 275 LB. TEST DOUBLE WALL (DW)



MODEL NO.	INSIDE DIM. L x W x H	VARIABLE DEPTH	PRICE PER BOX					BUNDLE/BALE QTY.	WT./BNDL.
			25	100	250	500	1,000+		
S-19077	24 x 18 x 18"	32 ECT LIGHTWEIGHT	\$2.84	\$2.84	\$2.84	\$2.84	\$2.84	15 / 150	35 lbs.
S-12651	24 x 18 x 18"	18,16,14,12,10"	5.86	5.23	4.93	4.38	4.07	15 / 120	40 lbs.
S-12652*	24 x 18 x 18"	275 LB. TEST	6.16	5.93	5.50	5.24	4.92	10 / 120	40 lbs.
S-4958•	24 x 18 x 18"	275 LB. TEST DW	8.19	7.32	6.94	6.37	6.07	10 / 90	42 lbs.
S-15042	24 x 18 x 20"		5.10	4.70	4.39	4.15	3.74	15 / 150	42 lbs.
■S-4960	24 x 18 x 24"		5.61	5.20	4.86	4.56	4.15	10 / 150	32 lbs.
■S-16460•	24 x 18 x 24"	275 LB. TEST DW	9.52	8.54	8.06	7.40	7.01	10 / 90	49 lbs.
■S-21563	24 x 18 x 36"		7.17	6.68	6.23	5.86	5.32	10 / 140	41 lbs.
S-16763	24 x 20 x 4"		3.42	3.21	3.01	2.79	2.54	20 / 240	39 lbs.
S-4448	24 x 20 x 6"		3.52	3.32	3.10	2.85	2.59	10 / 240	20 lbs.
S-13325	24 x 20 x 8"		4.06	3.75	3.53	3.22	3.00	20 / 140	43 lbs.
S-4907	24 x 20 x 10"		4.47	4.15	3.87	3.56	3.34	10 / 120	24 lbs.
S-4220	24 x 20 x 12"		4.72	4.47	4.14	3.83	3.55	10 / 120	26 lbs.
S-4865•	24 x 20 x 12"	275 LB. TEST DW	7.61	6.88	6.48	5.91	5.61	10 / 90	39 lbs.
S-4864	24 x 20 x 14"		4.91	4.59	4.27	3.99	3.67	10 / 120	28 lbs.
S-4739	24 x 20 x 16"		5.10	4.70	4.47	4.14	3.75	10 / 120	29 lbs.
S-4803	24 x 20 x 18"		5.24	4.86	4.59	4.27	3.89	10 / 120	30 lbs.
■S-4222	24 x 20 x 20"	200 LB. 5½ CU. FT.	5.44	5.03	4.70	4.39	4.01	10 / 120	32 lbs.
■S-22589	24 x 20 x 20"	32 ECT LIGHTWEIGHT	4.58	4.22	3.95	3.68	3.36	15 / 150	39 lbs.
■S-13326•	24 x 20 x 20"	275 LB. TEST DW	9.55	8.64	8.18	7.50	7.13	10 / 90	48 lbs.
■S-22209	24 x 20 x 24"		5.62	5.24	4.90	4.70	4.18	10 / 150	35 lbs.
■S-4777	24 x 20 x 34"	WARDROBE 51 ECT DW	15.32	13.72	12.03	10.88	9.74	5 / 80	29 lbs.
■S-4750	24 x 20 x 46"	WARDROBE 51 ECT DW	21.13	19.20	17.20	15.56	13.82	5 / 80	39 lbs.
■S-18044	24 x 22 x 60"	WARDROBE 51 ECT DW	30.92	29.47	28.19	27.02	26.18	5 / 80	49 lbs.
S-4450	24 x 24 x 4"		2.70	2.70	2.70	2.70	2.70	10 / 240	22 lbs.
S-4505	24 x 24 x 6"	200 LB. 2 CU. FT.	3.99	3.66	3.41	3.19	3.02	10 / 120	26 lbs.
S-22656	24 x 24 x 6"	32 ECT LIGHTWEIGHT	3.34	3.09	2.86	2.67	2.54	20 / 140	43 lbs.
S-18926•	24 x 24 x 6"	275 LB. TEST DW	7.86	7.12	6.75	6.14	5.86	10 / 90	42 lbs.
S-4548	24 x 24 x 7"		4.18	3.87	3.63	3.42	3.22	10 / 120	27 lbs.
S-11382	24 x 24 x 8"		4.34	4.01	3.72	3.53	3.34	10 / 120	28 lbs.
S-22591•	24 x 24 x 8"	275 LB. TEST DW	8.35	7.55	7.14	6.52	6.20	10 / 90	44 lbs.
S-4908	24 x 24 x 10"		4.50	4.18	3.89	3.66	3.43	10 / 120	30 lbs.
S-4320	24 x 24 x 12"	200 LB. 4 CU. FT.	3.44	3.44	3.44	3.44	3.44	10 / 120	30 lbs.
■S-22210	24 x 24 x 12"	32 ECT LIGHTWEIGHT	2.87	2.87	2.87	2.87	2.87	15 / 150	39 lbs.
S-4449	24 x 24 x 12"	12,10,8,6"	5.10	4.68	4.39	4.14	3.83	10 / 120	30 lbs.
■S-4910•	24 x 24 x 12"	275 LB. TEST DW	9.31	8.44	7.94	7.28	6.91	10 / 90	48 lbs.
■S-10656	24 x 24 x 14"		5.32	4.92	4.63	4.34	3.99	10 / 120	33 lbs.
■S-23295•	24 x 24 x 14"	275 LB. TEST DW	10.10	9.34	8.98	8.34	8.02	10 / 90	52 lbs.
■S-4223	24 x 24 x 16"	200 LB. TEST	5.60	5.18	4.84	4.51	4.16	10 / 120	35 lbs.
■S-23331	24 x 24 x 16"	32 ECT LIGHTWEIGHT	4.70	4.36	4.09	3.79	3.49	15 / 150	42 lbs.
■S-22117•	24 x 24 x 16"	275 LB. TEST DW	10.87	10.25	10.00	9.39	9.10	10 / 90	55 lbs.
■S-4474	24 x 24 x 18"	6 CU. FT.	5.87	5.44	5.10	4.72	4.38	10 / 120	36 lbs.
■S-10657•	24 x 24 x 18"	275 LB. TEST DW	11.39	10.75	10.48	9.84	9.55	10 / 90	56 lbs.
■S-4571	24 x 24 x 20"		6.05	5.71	5.32	5.12	4.56	10 / 120	37 lbs.
■S-20413•	24 x 24 x 20"	275 LB. TEST DW	11.93	11.25	10.96	10.30	9.99	10 / 90	61 lbs.
■S-19824	24 x 24 x 22"		6.39	6.07	5.65	5.43	4.84	10 / 150	40 lbs.
■S-4247	24 x 24 x 24"	200 LB. 8 CU. FT.	4.85	4.85	4.85	4.85	4.85	10 / 120	42 lbs.
■S-19078	24 x 24 x 24"	32 ECT LIGHTWEIGHT	4.04	4.04	4.04	4.04	4.04	15 / 150	53 lbs.
S-4115	24 x 24 x 24"	24,22,20,18,16"	6.98	6.44	6.20	5.60	5.40	15 / 120	60 lbs.
■S-11263	24 x 24 x 24"	WHITE	7.20	6.79	6.55	6.20	5.84	10 / 120	42 lbs.
■S-4773*	24 x 24 x 24"	275 LB. TEST	8.82	8.17	7.53	7.14	6.82	10 / 120	60 lbs.
■S-4776*	24 x 24 x 24"	24,22,20,18,16,14" 275 LB. TEST	9.04	8.42	7.76	7.40	7.12	10 / 120	60 lbs.
■S-4740•	24 x 24 x 24"	275 LB. TEST DW	7.52	7.52	7.52	7.52	7.52	10 / 90	63 lbs.
■S-20991	24 x 24 x 24"	500 LB. TEST DW	27.80	26.12	24.47	22.87	21.53	10 / 70	101 lbs.
■S-13331	24 x 24 x 24"	1,100 LB. TEST TW	35.00	34.00	33.00	31.00	29.00	5 / 30	68 lbs.
■S-20538	24 x 24 x 26"		8.38	7.70	7.22	6.71	6.12	10 / 150	43 lbs.
■S-19825	24 x 24 x 28"		8.69	8.02	7.51	6.97	6.36	10 / 120	45 lbs.
■S-4572	24 x 24 x 30"		9.01	8.29	7.81	7.23	6.61	10 / 120	47 lbs.
■S-21038•	24 x 24 x 30"	275 LB. TEST DW	13.55	12.65	12.31	11.56	11.16	5 / 90	37 lbs.
■S-4659	24 x 24 x 36"		9.21	8.58	8.02	7.48	6.87	5 / 120	25 lbs.
■S-14233•	24 x 24 x 36"	275 LB. TEST DW	13.86	13.02	12.63	11.92	11.58	5 / 90	40 lbs.
■S-14278	24 x 24 x 40 - 74"	TELESCOPIC	19.08	18.14	17.25	16.33	15.52	10 / 120	88 lbs.
■S-4549	24 x 24 x 48"		10.07	9.41	8.81	8.23	7.51	10 / 120	60 lbs.
■S-18927•	24 x 24 x 48"	275 LB. TEST DW	18.15	17.13	16.21	15.38	14.79	5 / 90	49 lbs.



S-4549  
24 x 24 x 48"  
TALL BOX

**LARGER QUANTITIES  
CALL FOR QUOTE**



S-4655  
24 x 14 x 18"

**SEE RED AND SAVE  
ON POPULAR SIZES !**



S-4740  
24 x 24 x 24"  
275 LB. TEST DW

\$7.52 per box any bundle qty.

SOLD IN BUNDLE QUANTITIES  
\* 275 LB. TEST  
• 275 LB. TEST DOUBLE WALL (DW)  
■ SHIPS VIA MOTOR FREIGHT



S-22182  
26 x 26 x 36"

**ORDER BY 6 PM FOR  
SAME DAY SHIPPING**



S-4930  
26 x 26 x 26"  
275 LB. TEST DW

**OVER 1,700 BOX SIZES  
ALWAYS IN STOCK**



S-14282  
26 x 20 x 12"

MODEL NO.	INSIDE DIM. L x W x H	VARIABLE DEPTH	PRICE PER BOX					BUNDLE/BALE QTY.	WT./BNDL.
			25	100	250	500	1,000+		
S-4661	25 x 16 x 16"		\$4.01	\$3.74	\$3.53	\$3.30	\$3.00	10 / 120	24 lbs.
■S-15043	25 x 25 x 12"		5.64	5.20	4.86	4.59	4.22	15 / 150	48 lbs.
■S-4911	25 x 25 x 20"		6.44	6.09	5.70	5.44	4.84	10 / 120	40 lbs.
■S-4699	25 x 25 x 25"		6.51	6.31	6.20	5.94	5.49	10 / 120	45 lbs.
■S-22118*	25 x 25 x 25"	275 LB. TEST DW	13.07	12.22	11.88	11.15	10.77	5 / 90	36 lbs.
S-22696	26 x 4 x 4"		1.27	1.18	1.12	1.07	.98	25 / 625	12 lbs.
S-4938	26 x 6 x 6"		1.44	1.38	1.25	1.12	1.06	25 / 500	18 lbs.
S-12653	26 x 6 x 20"	FOL	3.67	3.42	3.14	2.98	2.76	10 / 140	18 lbs.
S-14279	26 x 8 x 8"		1.84	1.69	1.57	1.42	1.36	25 / 375	25 lbs.
S-19826	26 x 10 x 4"		1.85	1.70	1.58	1.44	1.38	25 / 375	24 lbs.
S-4844	26 x 10 x 10"		2.61	2.43	2.26	2.10	1.94	25 / 250	33 lbs.
S-22697	26 x 12 x 10"		3.02	2.82	2.60	2.43	2.25	25 / 300	39 lbs.
S-4506	26 x 12 x 12"	200 LB. TEST	3.10	2.95	2.72	2.53	2.40	20 / 240	33 lbs.
S-21589	26 x 12 x 12"	32 ECT LIGHTWEIGHT	2.59	2.49	2.29	2.11	2.04	25 / 300	35 lbs.
S-22592*	26 x 12 x 12"	275 LB. TEST DW	5.03	4.51	4.28	3.90	3.71	15 / 180	40 lbs.
S-4662	26 x 13 x 8"		3.09	2.94	2.71	2.51	2.39	20 / 240	32 lbs.
S-21590	26 x 14 x 10"		3.13	3.00	2.90	2.69	2.51	25 / 250	44 lbs.
S-21060	26 x 14 x 12"		3.40	3.23	3.13	2.91	2.71	20 / 240	38 lbs.
S-4959	26 x 14 x 14"		3.55	3.42	3.30	3.02	2.82	15 / 150	30 lbs.
S-4303	26 x 15 x 5"		3.52	3.32	3.19	2.99	2.69	20 / 240	32 lbs.
S-4550	26 x 15 x 7"		4.00	3.75	3.66	3.52	3.09	20 / 240	32 lbs.
S-4804	26 x 15 x 12"		4.22	3.93	3.72	3.55	3.14	20 / 240	40 lbs.
S-12654	26 x 16 x 10"		4.06	3.71	3.41	3.22	2.95	20 / 240	38 lbs.
S-23989	26 x 16 x 12"		4.24	3.94	3.74	3.56	3.17	20 / 140	43 lbs.
S-4663	26 x 16 x 14"		4.39	4.05	3.77	3.66	3.21	15 / 120	35 lbs.
S-18368	26 x 16 x 16"		4.51	4.18	3.89	3.69	3.36	15 / 150	36 lbs.
S-4741	26 x 16 x 19"		4.63	4.34	4.01	3.74	3.54	10 / 120	28 lbs.
S-18369	26 x 17 x 5"		3.53	3.32	3.14	2.96	2.69	25 / 300	43 lbs.
S-16780	26 x 18 x 10"		4.11	3.77	3.54	3.32	3.01	15 / 150	34 lbs.
S-4228	26 x 18 x 12"		4.39	4.05	3.77	3.53	3.21	15 / 120	36 lbs.
S-22593*	26 x 18 x 12"	275 LB. TEST DW	7.20	6.46	6.13	5.61	5.30	10 / 90	38 lbs.
S-22698	26 x 18 x 14"		4.47	4.10	3.88	3.58	3.26	15 / 150	39 lbs.
S-4225	26 x 18 x 16"		4.51	4.18	3.98	3.66	3.36	10 / 120	27 lbs.
S-4573	26 x 18 x 16"	16,14,12,10"	5.43	4.98	4.68	4.34	4.01	10 / 120	27 lbs.
S-21061	26 x 18 x 18"		4.83	4.47	4.14	3.90	3.58	15 / 150	43 lbs.
S-14280	26 x 20 x 4"	GARMENT BOX	3.56	3.35	3.14	2.92	2.67	20 / 240	39 lbs.
S-13327	26 x 20 x 6"	GARMENT BOX	3.86	3.56	3.35	3.13	2.85	20 / 240	42 lbs.
S-18370	26 x 20 x 8"	GARMENT BOX	4.07	3.77	3.55	3.32	3.09	15 / 150	35 lbs.
S-14281	26 x 20 x 10"	GARMENT BOX	4.48	4.16	3.88	3.57	3.35	15 / 150	36 lbs.
S-14282	26 x 20 x 12"	GARMENT BOX	4.51	4.18	3.93	3.63	3.41	15 / 150	39 lbs.
S-4507	26 x 20 x 12"	12,10,8,6,4"	3.37	3.37	3.37	3.37	3.37	10 / 120	26 lbs.
S-18371	26 x 20 x 14"	GARMENT BOX	4.68	4.34	4.00	3.72	3.49	15 / 150	42 lbs.
S-10658	26 x 20 x 16"	GARMENT BOX	4.83	4.47	4.09	3.86	3.55	10 / 120	30 lbs.
■S-12655	26 x 20 x 18"		4.93	4.56	4.17	3.98	3.66	10 / 150	32 lbs.
■S-4700	26 x 20 x 20"		5.10	4.69	4.21	4.05	3.72	10 / 120	34 lbs.
■S-4000*	26 x 20 x 20"	20,18,16,14,12,10" 275 LB. TEST	7.23	6.56	6.36	5.71	5.20	10 / 120	46 lbs.
■S-11256*	26 x 20 x 20"	275 LB. TEST DW	9.74	8.84	8.36	7.69	7.31	10 / 90	51 lbs.
S-23990	26 x 22 x 10"		4.70	4.34	4.01	3.77	3.52	15 / 150	42 lbs.
S-18372	26 x 22 x 12"		4.90	4.51	4.18	3.93	3.64	15 / 150	44 lbs.
S-15044	26 x 26 x 4"		5.16	4.79	4.47	4.09	3.74	15 / 150	41 lbs.
S-4664	26 x 26 x 6"		5.33	4.92	4.51	4.26	3.89	10 / 120	30 lbs.
S-16781	26 x 26 x 8"		5.46	5.04	4.63	4.38	4.01	10 / 150	32 lbs.
■S-12656	26 x 26 x 10"		5.76	5.32	4.91	4.63	4.22	10 / 150	34 lbs.
■S-4912	26 x 26 x 12"		6.10	5.61	5.18	4.86	4.50	10 / 120	36 lbs.
■S-18167*	26 x 26 x 12"	275 LB. TEST DW	11.16	10.55	10.26	9.62	9.39	10 / 90	54 lbs.
■S-18373	26 x 26 x 14"		6.25	5.79	5.36	5.07	4.70	10 / 150	37 lbs.
■S-14283	26 x 26 x 16"		6.44	5.97	5.55	5.26	4.91	10 / 150	38 lbs.
■S-4963	26 x 26 x 20"		6.82	6.47	6.05	5.77	5.39	10 / 150	43 lbs.
■S-21036*	26 x 26 x 20"	275 LB. TEST DW	13.45	12.67	12.34	11.60	11.28	10 / 90	68 lbs.
■S-4190	26 x 26 x 26"		7.60	7.25	6.88	6.48	6.07	10 / 120	49 lbs.
■S-4451	26 x 26 x 26"	26,24,22,20"	8.81	8.02	7.76	6.97	6.69	10 / 120	49 lbs.
■S-4930*	26 x 26 x 26"	275 LB. TEST DW	15.16	14.32	13.93	13.07	12.73	5 / 90	36 lbs.
■S-22182	26 x 26 x 36"		10.30	9.58	8.94	8.35	7.66	10 / 150	58 lbs.
S-4828	27 x 14 x 9"		4.21	4.00	3.87	3.71	3.32	20 / 240	36 lbs.
■S-4742	27 x 27 x 27"		8.34	7.91	7.43	7.13	6.66	5 / 120	25 lbs.

SOLD IN BUNDLE QUANTITIES

- \* 275 LB. TEST
- 275 LB. TEST DOUBLE WALL (DW)
- FOL = FULL OVERLAP
- SHIPS VIA MOTOR FREIGHT

MODEL NO.	INSIDE DIM. L x W x H / VARIABLE DEPTH	PRICE PER BOX					BUNDLE/BALE QTY.	WT./BNDL.	
		25	100	250	500	1,000+			
S-21037	28 x 4 x 4"		\$1.42	\$1.32	\$1.25	\$1.23	\$1.11	25 / 625	13 lbs.
S-4805	28 x 4 x 24"	FOL	3.71	3.49	3.21	3.00	2.79	10 / 120	19 lbs.
■S-4768	28 x 5½ x 38"	FOL	5.19	4.84	4.50	4.16	3.98	20 / 120	58 lbs.
S-4452	28 x 6 x 6"		1.58	1.44	1.39	1.29	1.18	20 / 480	14 lbs.
■S-10659	28 x 6 x 52"	FOL, CRIB MATTRESS	8.36	8.14	7.93	7.81	7.62	5 / 125	18 lbs.
S-4913	28 x 8 x 8"		1.92	1.71	1.61	1.52	1.42	25 / 375	26 lbs.
S-18374	28 x 10 x 10"		2.69	2.50	2.32	2.16	1.98	25 / 300	35 lbs.
S-4946	28 x 12 x 6"		2.60	2.40	2.26	2.10	1.92	25 / 300	33 lbs.
S-16782	28 x 12 x 8"		2.90	2.69	2.51	2.36	2.10	25 / 300	37 lbs.
S-22659	28 x 12 x 10"		3.07	2.85	2.62	2.46	2.28	25 / 300	41 lbs.
S-4914	28 x 12 x 12"		3.13	2.98	2.75	2.55	2.44	20 / 240	35 lbs.
S-16783	28 x 14 x 14"		4.21	3.93	3.64	3.42	3.10	20 / 140	43 lbs.
S-23329	28 x 15 x 15"		4.24	3.95	3.66	3.44	3.12	20 / 140	47 lbs.
S-19828	28 x 16 x 5"		3.63	3.34	3.14	2.96	2.71	25 / 300	42 lbs.
S-4743	28 x 16 x 7"		3.74	3.49	3.21	3.03	2.76	20 / 240	35 lbs.
S-4915	28 x 16 x 10"		4.01	3.71	3.49	3.20	2.99	20 / 240	40 lbs.
S-4408	28 x 16 x 12"		4.34	4.00	3.76	3.43	3.20	25 / 125	55 lbs.
S-4508	28 x 16 x 14"		4.51	4.18	3.98	3.58	3.35	15 / 120	35 lbs.
S-4766	28 x 17 x 5"		3.66	3.35	3.14	2.99	2.73	15 / 300	27 lbs.
S-19829	28 x 18 x 6"		3.74	3.43	3.21	3.01	2.76	20 / 240	40 lbs.
S-18375	28 x 18 x 8"		4.05	3.71	3.52	3.19	2.96	15 / 150	33 lbs.
S-20539	28 x 18 x 10"		4.37	3.99	3.76	3.43	3.19	15 / 150	35 lbs.
S-11383	28 x 18 x 12"		4.66	4.27	4.01	3.67	3.41	15 / 120	37 lbs.
S-4962	28 x 18 x 18"		5.05	4.66	4.18	4.00	3.69	10 / 150	31 lbs.
■S-18168 •	28 x 18 x 18"	275 LB. TEST DW	9.19	8.24	7.81	7.21	6.93	10 / 90	46 lbs.
S-22183	28 x 20 x 10"		4.70	4.37	4.06	3.76	3.49	15 / 150	39 lbs.
S-12611	28 x 20 x 12"		4.84	4.50	4.15	3.87	3.56	15 / 150	40 lbs.
■S-16784	28 x 20 x 20"		6.02	5.36	5.24	4.87	4.48	10 / 150	35 lbs.
■S-4806	28 x 20 x 24"	24,22,20,18,16,14"	7.53	7.17	6.82	6.47	6.05	10 / 120	40 lbs.
■S-4665	28 x 20 x 25"		7.40	6.98	6.65	6.24	5.84	10 / 120	40 lbs.
S-4459	28 x 24 x 6"		5.02	4.60	4.32	4.01	3.72	10 / 240	27 lbs.
■S-22660	28 x 24 x 12"		5.35	4.92	4.50	4.24	3.93	15 / 150	51 lbs.
■S-16785	28 x 24 x 20"		6.66	6.18	5.86	5.65	5.36	10 / 150	41 lbs.
■S-4829	28 x 28 x 6"		5.75	5.46	5.16	4.98	4.50	10 / 120	33 lbs.
■S-20543	28 x 28 x 8"		5.98	5.71	5.40	5.18	4.66	10 / 150	37 lbs.
■S-19086	28 x 28 x 10"		6.24	5.95	5.61	5.39	4.83	10 / 150	39 lbs.
■S-4666	28 x 28 x 12"		6.31	6.05	5.66	5.44	4.86	10 / 120	40 lbs.
■S-21541 •	28 x 28 x 12"	275 LB. TEST DW	12.63	11.92	11.60	10.85	10.58	10 / 90	64 lbs.
■S-4866	28 x 28 x 20"		7.85	7.23	6.79	6.62	6.29	10 / 120	47 lbs.
■S-19830	28 x 28 x 22"		8.18	7.53	7.10	6.89	6.56	10 / 150	50 lbs.
■S-4433	28 x 28 x 28"		9.15	8.44	7.92	7.73	7.31	5 / 120	28 lbs.
■S-16461 •	28 x 28 x 28"	275 LB. TEST DW	17.56	16.57	16.11	15.12	14.72	5 / 90	43 lbs.
S-14284	29 x 17 x 3"	GARMENT BOX	3.20	3.01	2.80	2.60	2.44	25 / 300	41 lbs.
S-11384	29 x 17 x 5"	GARMENT BOX	3.35	3.19	2.99	2.76	2.60	15 / 300	31 lbs.
S-13328	29 x 17 x 7"	GARMENT BOX	3.67	3.49	3.22	3.02	2.80	20 / 240	38 lbs.
S-4807	29 x 17 x 9"	GARMENT BOX	3.98	3.74	3.53	3.22	3.03	15 / 150	32 lbs.
S-14285	29 x 17 x 9"	9,7,5,3" GARMENT	4.37	4.17	3.88	3.58	3.36	15 / 150	32 lbs.
S-4808	29 x 17 x 12"	GARMENT BOX	4.22	4.00	3.74	3.49	3.22	15 / 150	38 lbs.
S-4701	29 x 17 x 15"	GARMENT BOX	4.59	4.27	4.00	3.69	3.43	15 / 150	40 lbs.
S-4767	29 x 17 x 20"	GARMENT BOX	5.03	4.70	4.47	4.15	3.87	10 / 120	32 lbs.
■S-14300	29 x 24 x 24"		8.19	7.80	7.31	6.69	6.30	10 / 150	44 lbs.
S-4553	30 x 5 x 24"	FOL	2.73	2.73	2.73	2.73	2.73	10 / 120	21 lbs.
S-4744	30 x 6 x 6"		1.81	1.65	1.49	1.40	1.34	25 / 375	20 lbs.
S-18320*	30 x 6 x 24"	FOL, 275 LB. TEST	8.02	7.23	6.54	5.98	5.61	10 / 140	33 lbs.
S-12612	30 x 6 x 24 - 44"	TELESCOPIC	11.24	10.76	10.32	9.80	9.26	10 / 120	44 lbs.
S-10660*	30 x 6 x 30"	FOL, 275 LB. TEST	9.31	8.44	7.60	6.97	6.54	10 / 120	34 lbs.
■S-18321*	30 x 6 x 40"	FOL, 275 LB. TEST	11.51	10.42	9.40	8.63	8.05	10 / 140	48 lbs.
S-18377	30 x 8 x 8"		2.04	1.88	1.73	1.63	1.52	25 / 375	28 lbs.
S-4939	30 x 10 x 10"		2.29	2.11	1.97	1.88	1.73	20 / 240	30 lbs.
S-18378	30 x 12 x 4"		2.99	2.72	2.57	2.40	2.18	25 / 375	31 lbs.
S-21051	30 x 12 x 6"		3.01	2.76	2.60	2.48	2.22	25 / 250	35 lbs.
S-16774	30 x 12 x 12"		3.14	2.99	2.76	2.57	2.49	20 / 240	35 lbs.
S-23964 •	30 x 12 x 12"	275 LB. TEST DW	5.89	5.43	5.23	4.79	4.52	15 / 180	44 lbs.
S-13329	30 x 13 x 13"		3.49	3.32	3.09	2.85	2.72	20 / 240	39 lbs.
S-4809	30 x 14 x 7"		2.85	2.69	2.59	2.44	2.33	10 / 240	19 lbs.



S-18168  
28 x 18 x 18"  
275 LB. TEST DW

**SEE RED AND SAVE  
ON POPULAR SIZES !**



S-4914  
28 x 12 x 12"

**LARGER QUANTITIES  
CALL FOR QUOTE**



SOLD IN BUNDLE QUANTITIES  
\* 275 LB. TEST  
• 275 LB. TEST DOUBLE WALL (DW)  
FOL = FULL OVERLAP  
■ SHIPS VIA MOTOR FREIGHT





S-15109  
36 x 36 x 40 - 76"  
TELESCOPIC

**OVER 1,700 BOX SIZES  
ALWAYS IN STOCK**



S-18380  
32 x 18 x 18"

**ORDER BY 6 PM FOR  
SAME DAY SHIPPING**



S-12613  
30 x 24 x 12"  
275 LB. TEST DW

SOLD IN BUNDLE QUANTITIES  
\* 275 LB. TEST  
• 275 LB. TEST DOUBLE WALL (DW)  
FOL = FULL OVERLAP  
■ SHIPS VIA MOTOR FREIGHT

MODEL NO.	INSIDE DIM. L x W x H	VARIABLE DEPTH	PRICE PER BOX					BUNDLE/BALE QTY.	WT./BNDL.
			25	100	250	500	1,000+		
S-4403	30 x 14 x 10"		\$3.32	\$3.11	\$2.95	\$2.69	\$2.54	10 / 240	20 lbs.
S-4551	30 x 15 x 15"		4.27	3.98	3.68	3.46	3.14	15 / 120	36 lbs.
S-21542*	30 x 15 x 15"	275 LB. TEST DW	7.66	7.21	7.03	6.65	6.44	10 / 90	39 lbs.
S-4404	30 x 17 x 16"		4.63	4.34	4.01	3.74	3.54	15 / 150	43 lbs.
S-18982	30 x 17 x 16"	16,14,12,10"	5.13	4.72	4.39	4.11	3.89	15 / 150	43 lbs.
S-4964	30 x 17 x 17"	*EO* CNINR. 350 LB. TEST DW	12.50	11.65	11.30	10.75	10.35	5 / 75	23 lbs.
S-21052	30 x 18 x 16"		5.14	4.59	4.50	4.15	3.82	15 / 150	45 lbs.
S-11385	30 x 18 x 18"		5.46	4.86	4.76	4.39	4.05	10 / 120	30 lbs.
■S-21039*	30 x 18 x 18"	275 LB. TEST DW	9.74	9.19	8.92	8.44	8.17	10 / 90	50 lbs.
S-23995	30 x 20 x 4"		3.46	3.24	3.09	2.85	2.69	20 / 140	44 lbs.
S-11386	30 x 20 x 6"		3.53	3.32	3.13	2.90	2.73	15 / 150	35 lbs.
S-19091	30 x 20 x 8"		3.82	3.55	3.34	3.11	2.96	15 / 150	38 lbs.
S-4667	30 x 20 x 10"		4.05	3.77	3.56	3.32	3.13	15 / 150	40 lbs.
S-4928	30 x 20 x 12"		4.32	4.06	3.83	3.54	3.34	15 / 150	43 lbs.
■S-15081	30 x 20 x 18"		5.94	5.29	5.18	4.83	4.47	15 / 150	50 lbs.
■S-4229	30 x 20 x 20"	7 CU. FT.	6.25	5.60	5.46	5.07	4.66	10 / 120	35 lbs.
■S-4001*	30 x 20 x 20"	20,18,16,14,12,10" 275 LB. TEST	7.70	7.28	6.94	6.55	5.77	10 / 120	50 lbs.
■S-4775*	30 x 20 x 20"	275 LB. TEST DW	11.24	10.58	10.30	9.70	9.42	10 / 90	55 lbs.
S-22695	30 x 24 x 6"		5.20	4.76	4.41	4.14	3.87	15 / 150	44 lbs.
■S-13330	30 x 24 x 10"		5.28	4.84	4.49	4.20	3.93	15 / 150	47 lbs.
■S-4417	30 x 24 x 12"	5 CU. FT.	5.55	5.10	4.68	4.39	4.09	15 / 120	51 lbs.
■S-11248	30 x 24 x 12"	12,10,8,6,4"	6.14	5.56	5.13	4.84	4.50	15 / 120	51 lbs.
■S-12613*	30 x 24 x 12"	275 LB. TEST DW	10.42	9.88	9.57	9.01	8.78	10 / 90	54 lbs.
■S-4961	30 x 24 x 20"		6.91	6.44	6.09	5.87	5.56	10 / 150	41 lbs.
■S-4509*	30 x 24 x 24"	24,22,20,18,16,14" 275 LB. TEST	10.36	9.57	9.19	8.54	7.76	10 / 120	65 lbs.
■S-16775	30 x 26 x 24"		8.61	8.13	7.65	7.00	6.62	10 / 150	50 lbs.
■S-14301	30 x 30 x 6"		6.56	6.07	5.77	5.46	5.03	10 / 150	38 lbs.
■S-4845	30 x 30 x 8"		6.82	6.29	6.05	5.66	5.26	10 / 120	43 lbs.
■S-15082	30 x 30 x 10"		7.00	6.47	6.18	5.86	5.39	10 / 150	42 lbs.
■S-10661	30 x 30 x 12"		7.20	6.65	6.31	5.94	5.52	10 / 120	45 lbs.
■S-20414*	30 x 30 x 12"	275 LB. TEST DW	13.43	12.71	12.33	11.60	11.30	5 / 90	36 lbs.
■S-4668	30 x 30 x 16"		7.59	6.97	6.66	6.29	5.79	10 / 120	46 lbs.
■S-20415*	30 x 30 x 16"	275 LB. TEST DW	14.69	13.89	13.47	12.66	12.36	5 / 90	39 lbs.
■S-16776	30 x 30 x 20"		8.94	8.26	7.92	7.14	6.87	10 / 150	54 lbs.
■S-21034*	30 x 30 x 20"	275 LB. TEST DW	16.91	15.97	15.54	14.56	14.18	5 / 90	43 lbs.
■S-4745	30 x 30 x 25"		9.10	8.39	8.14	7.31	7.09	5 / 120	25 lbs.
■S-4366	30 x 30 x 30"		10.53	9.69	9.10	8.89	8.39	5 / 120	33 lbs.
■S-4867*	30 x 30 x 30"	275 LB. TEST DW	20.24	19.09	18.57	17.40	16.99	5 / 90	48 lbs.
■S-11301	30 x 30 x 30"	1,100 LB. TEST TW	54.00	52.00	50.00	48.00	46.00	5 / 30	105 lbs.
■S-23297	30 x 30 x 40 - 74"	TELESCOPIC	25.00	24.00	23.00	22.00	20.00	10 / 120	119 lbs.
S-4746	31 x 16 x 9"		4.34	4.00	3.72	3.43	3.20	10 / 120	25 lbs.
S-4669	32 x 6 x 6"		2.04	1.81	1.69	1.52	1.40	25 / 375	21 lbs.
S-4810	32 x 8 x 8"		2.10	1.94	1.79	1.70	1.58	25 / 375	29 lbs.
S-4304	32 x 10 x 6 1/2"		2.11	1.96	1.81	1.71	1.60	20 / 240	28 lbs.
S-18379	32 x 10 x 10"		2.72	2.51	2.36	2.25	2.04	20 / 240	31 lbs.
S-19092	32 x 12 x 10"		3.13	2.88	2.71	2.57	2.32	20 / 240	36 lbs.
S-4868	32 x 12 x 12"		3.34	3.09	2.91	2.76	2.51	20 / 240	40 lbs.
S-16777	32 x 16 x 16"		4.68	4.34	4.07	3.74	3.52	15 / 150	42 lbs.
S-19827	32 x 18 x 8"		4.09	3.87	3.61	3.34	3.14	15 / 150	36 lbs.
S-10662	32 x 18 x 12"		4.21	4.00	3.74	3.49	3.30	15 / 150	42 lbs.
■S-18380	32 x 18 x 18"		5.82	5.40	5.04	4.70	4.34	15 / 150	49 lbs.
■S-15083	32 x 24 x 24"		8.63	8.02	7.50	6.98	6.44	10 / 150	47 lbs.
■S-4453*	32 x 24 x 24"	24,22,20,18,16,14" 275 LB. TEST	7.51	7.51	7.51	7.51	7.51	10 / 120	65 lbs.
■S-11257*	32 x 24 x 24"	275 LB. TEST DW	13.02	12.23	11.92	11.26	10.95	5 / 90	36 lbs.
■S-20544	32 x 32 x 8"		8.59	8.04	7.55	7.03	6.93	10 / 150	46 lbs.
■S-16778	32 x 32 x 12"		8.94	8.34	7.82	7.23	7.12	10 / 150	51 lbs.
■S-4434	32 x 32 x 32"	MAX. UPS SIZE	11.61	11.04	10.62	10.07	9.74	5 / 120	37 lbs.
■S-16462*	32 x 32 x 32"	275 LB. TEST DW	22.96	21.69	21.04	19.76	19.27	5 / 90	56 lbs.
S-14258	33 x 8 1/2 x 5"	SKATEBOARD BOX	2.17	2.05	1.96	1.85	1.70	25 / 375	26 lbs.
S-4670	34 x 10 x 6"		2.36	2.17	2.04	1.96	1.81	20 / 240	25 lbs.
S-4846	34 x 21 x 6"		5.13	4.84	4.51	4.32	3.99	10 / 120	26 lbs.
■S-4435	34 x 34 x 34"		12.61	11.94	11.50	11.16	10.87	5 / 120	42 lbs.
S-4671	36 x 4 x 4"		1.73	1.58	1.42	1.34	1.23	25 / 500	15 lbs.
S-4947	36 x 5 x 24"	FOL	4.27	4.09	3.82	3.53	3.32	10 / 140	26 lbs.
■S-4554	36 x 5 x 30"	FOL	4.04	4.04	4.04	4.04	4.04	20 / 120	54 lbs.

MODEL NO.	INSIDE DIM. L x W x H	VARIABLE DEPTH	PRICE PER BOX					BUNDLE/BALE QTY.	WT./BNDL.
			25	100	250	500	1,000+		
■S-4680*	36 x 5½ x 48"	FOL, 275 LB. TEST	\$13.18	\$12.19	\$10.80	\$9.79	\$8.87	10 / 140	62 lbs.
S-4367	36 x 6 x 6"		1.98	1.92	1.79	1.70	1.60	25 / 375	23 lbs.
■S-10663*	36 x 6 x 36"	FOL, 275 LB. TEST	12.85	11.62	10.58	9.65	8.82	10 / 120	46 lbs.
■S-4679*	36 x 6 x 42"	FOL, 275 LB. TEST	7.92	7.92	7.92	7.92	7.92	10 / 140	52 lbs.
S-18427	36 x 8 x 4"		2.04	1.96	1.84	1.73	1.61	25 / 375	24 lbs.
S-4361	36 x 8 x 8"		2.21	2.07	1.97	1.83	1.64	25 / 250	33 lbs.
S-18928•	36 x 8 x 8"	275 LB. TEST DW	4.26	3.88	3.69	3.41	3.21	15 / 180	32 lbs.
■S-11212*	36 x 8 x 30"	FOL, 275 LB. TEST	11.17	10.20	9.21	8.26	7.63	10 / 140	44 lbs.
S-18428	36 x 10 x 6"		2.54	2.38	2.17	2.08	1.96	25 / 250	34 lbs.
S-4672	36 x 10 x 10"		2.61	2.44	2.26	2.16	2.02	20 / 240	34 lbs.
S-4830	36 x 12 x 4"		3.41	3.11	2.95	2.75	2.51	20 / 240	28 lbs.
S-14302	36 x 12 x 6"		3.56	3.23	3.11	2.91	2.59	20 / 240	31 lbs.
S-21566	36 x 12 x 8"		3.63	3.32	3.13	2.94	2.64	20 / 240	35 lbs.
S-4673	36 x 12 x 10"		3.67	3.35	3.14	2.95	2.68	15 / 150	29 lbs.
S-4418	36 x 12 x 12"	3 CU. FT.	2.58	2.58	2.58	2.58	2.58	15 / 120	31 lbs.
S-11258•	36 x 12 x 12"	275 LB. TEST DW	6.29	5.70	5.39	4.91	4.66	10 / 90	32 lbs.
S-21066	36 x 12 x 16"		4.34	4.05	3.75	3.56	3.22	15 / 150	37 lbs.
S-21567	36 x 14 x 6"		3.67	3.41	3.17	2.99	2.69	20 / 240	37 lbs.
S-4232	36 x 14 x 10"		3.74	3.49	3.21	3.03	2.76	15 / 150	33 lbs.
S-21035	36 x 14 x 14"		4.49	4.18	3.90	3.71	3.36	15 / 150	38 lbs.
S-16779	36 x 16 x 5"		3.64	3.41	3.13	2.90	2.69	15 / 300	30 lbs.
S-22699	36 x 16 x 7"		3.97	3.72	3.43	3.17	2.94	15 / 150	33 lbs.
S-4405	36 x 16 x 16"		5.05	4.68	4.39	4.06	3.77	15 / 150	46 lbs.
S-16463•	36 x 16 x 16"	275 LB. TEST DW	8.89	8.34	7.94	7.60	7.31	10 / 90	48 lbs.
S-15084	36 x 18 x 6"		4.32	4.01	3.69	3.42	3.19	15 / 150	34 lbs.
S-4702	36 x 18 x 12"		4.79	4.48	4.15	3.87	3.58	15 / 150	45 lbs.
S-19775•	36 x 18 x 12"	275 LB. TEST DW	8.66	8.14	7.74	7.40	7.13	10 / 90	47 lbs.
■S-13332	36 x 18 x 18"		6.68	6.24	5.91	5.49	5.26	15 / 150	50 lbs.
■S-18169•	36 x 18 x 18"	275 LB. TEST DW	10.62	9.98	9.52	9.08	8.71	10 / 90	53 lbs.
S-18429	36 x 20 x 9"	GARMENT BOX	5.88	5.51	5.18	4.84	4.60	15 / 150	44 lbs.
■S-12771	36 x 20 x 12"	GARMENT BOX	5.94	5.56	5.24	4.91	4.68	15 / 150	46 lbs.
■S-4769	36 x 20 x 15"	GARMENT BOX	6.87	6.41	6.09	5.61	5.44	10 / 120	38 lbs.
S-4965	36 x 21 x 10"	LAYDOWN WARDROBE	6.54	6.20	5.86	5.54	5.26	10 / 150	30 lbs.
■S-4368	36 x 21 x 20"		7.17	6.76	6.44	6.16	5.77	5 / 120	21 lbs.
■S-4682•	36 x 22 x 22"	"EH" CNTNR. 275 LB. TEST DW	21.10	21.00	19.70	18.15	17.80	5 / 90	39 lbs.
S-4747	36 x 24 x 4"		5.93	5.61	5.23	5.03	4.49	10 / 120	29 lbs.
S-4811	36 x 24 x 6"		6.20	5.87	5.50	5.20	4.80	10 / 120	30 lbs.
■S-4917	36 x 24 x 8"		6.51	6.14	5.75	5.44	5.12	10 / 120	30 lbs.
■S-21543•	36 x 24 x 8"	275 LB. TEST DW	10.22	9.61	9.15	8.71	8.42	10 / 90	55 lbs.
■S-19194	36 x 24 x 10"		6.65	6.25	5.88	5.52	5.29	10 / 150	37 lbs.
■S-4454	36 x 24 x 12"	6 CU. FT.	6.77	6.37	6.02	5.60	5.43	10 / 120	39 lbs.
■S-14234•	36 x 24 x 12"	275 LB. TEST DW	11.47	10.76	10.26	9.79	9.43	5 / 90	30 lbs.
■S-16765	36 x 24 x 18"		7.37	7.11	6.87	6.56	6.30	10 / 150	45 lbs.
■S-22119•	36 x 24 x 18"	275 LB. TEST DW	13.13	12.23	11.88	11.27	10.93	5 / 90	36 lbs.
■S-4192	36 x 24 x 20"		7.51	7.20	6.93	6.65	6.37	5 / 120	24 lbs.
■S-4674	36 x 24 x 24"		9.21	8.58	8.02	7.48	6.87	5 / 120	27 lbs.
■S-13333•	36 x 24 x 24"	275 LB. TEST DW	14.03	13.18	12.78	12.04	11.69	5 / 90	39 lbs.
■S-19870	36 x 30 x 12"		8.81	8.24	7.69	7.13	6.97	10 / 150	50 lbs.
■S-4510	36 x 36 x 12"	9 CU. FT.	11.71	10.95	10.23	9.49	9.29	5 / 125	31 lbs.
■S-18170•	36 x 36 x 12"	275 LB. TEST DW	19.51	18.30	17.52	16.65	16.19	5 / 90	47 lbs.
■S-4457	36 x 36 x 18"		12.02	11.40	10.65	9.89	9.42	5 / 120	34 lbs.
■S-22594•	36 x 36 x 18"	275 LB. TEST DW	21.88	20.54	19.66	18.70	18.16	5 / 90	55 lbs.
■S-4478	36 x 36 x 24"	18 CU. FT.	12.05	11.51	11.29	10.83	10.44	5 / 125	38 lbs.
■S-15061•	36 x 36 x 24"	275 LB. TEST DW	24.25	22.76	21.81	20.72	20.15	5 / 90	59 lbs.
■S-4681	36 x 36 x 24"	600 LB. TEST DW	52.05	49.95	47.85	45.00	44.15	5 / 50	98 lbs.
■S-4193	36 x 36 x 36"		10.53	10.53	10.53	10.53	10.53	5 / 120	46 lbs.
■S-4373	36 x 36 x 36"	36,24,22,20"	13.02	12.85	12.66	11.82	11.35	5 / 120	46 lbs.
■S-4966•	36 x 36 x 36"	275 LB. TEST DW	31.91	29.92	28.45	27.27	26.46	5 / 90	67 lbs.
■S-11300	36 x 36 x 36"	1,100 LB. TW HSC	58.00	56.00	55.00	54.00	52.00	5 / 30	125 lbs.
■S-15109	36 x 36 x 40 - 76"	TELESCOPIC	31.00	29.00	28.00	25.00	24.00	5 / 125	74 lbs.
S-4778	37 x 4 x 30 - 60"	TELESCOPIC	15.79	15.02	14.29	13.65	13.18	10 / 120	40 lbs.
■S-10664	39 x 8 x 75"	TWIN MATTRESS	16.29	15.79	15.14	14.73	14.37	5 / 125	23 lbs.
■S-4929*	40 x 5 x 45"	FOL, 275 LB. TEST	16.09	14.53	13.22	12.06	11.01	10 / 140	58 lbs.
S-18430	40 x 6 x 6"		2.61	2.38	2.08	1.95	1.79	25 / 375	26 lbs.
S-4748	40 x 8 x 8"		3.20	2.96	2.68	2.53	2.38	25 / 250	36 lbs.



S-4778  
37 x 4 x 30 - 60"  
TELESCOPIC

LARGER QUANTITIES  
CALL FOR QUOTE



S-3397  
36 x 24 x 1, 2, 4, 6"  
JUMBO MAILER

Easy-Fold Jumbo Mailers  
Package large, flat items,  
see page 76.

SEE RED AND SAVE  
ON POPULAR SIZES !



S-4193  
36 x 36 x 36"

\$10.53 per box any bundle qty.

SOLD IN BUNDLE QUANTITIES  
\* 275 LB. TEST  
• 275 LB. TEST DOUBLE WALL (DW)  
HSC = REGULAR BOTTOM WITH TOP LID  
FOL = FULL OVERLAP  
■ SHIPS VIA MOTOR FREIGHT



**BULK CARGO BOXES,  
PAGES 43-45**

S-4480

48 x 40 x 36" GAYLORD BOX

\$25.90 per box any bundle qty.

**IN STOCK. SHIPS  
FROM 13 LOCATIONS.**



S-18935

48 x 40 x 24"  
GAYLORD BOX

**ORDER BY 6 PM FOR  
SAME DAY SHIPPING**



S-4812

48 x 40 x 36"  
51 ECT DW EASY LOADER

SOLD IN BUNDLE QUANTITIES

\* 275 LB. TEST

• 275 LB. TEST DOUBLE WALL (DW)

RSC = REGULAR TOP AND BOTTOM FLAPS

HSC = REGULAR BOTTOM WITH TOP LID

FOL = FULL OVERLAP

■ SHIPS VIA MOTOR FREIGHT

MODEL NO.	INSIDE DIM. L x W x H	VARIABLE DEPTH	PRICE PER BOX					BUNDLE/BALE QTY.	WT./BNDL.
			25	100	250	500	1,000+		
■S-11213 •	40 x 8 x 50"	FOL, 275 LB. TEST DW	\$22.23	\$20.09	\$18.31	\$17.32	\$15.79	5 / 90	38 lbs.
S-19195	40 x 10 x 10"		4.22	3.93	3.66	3.49	3.13	15 / 300	28 lbs.
S-10665	40 x 12 x 12"		4.87	4.56	4.22	4.06	3.72	15 / 120	33 lbs.
S-21544 •	40 x 12 x 12"	275 LB. TEST DW	7.22	6.77	6.51	6.18	6.02	10 / 90	37 lbs.
S-21033	40 x 14 x 14"		6.35	5.88	5.49	5.20	4.69	15 / 150	41 lbs.
S-12772	40 x 18 x 8"		5.46	5.14	4.83	4.56	4.27	15 / 150	39 lbs.
■S-23336	40 x 20 x 10"		6.51	6.12	5.75	5.42	5.07	10 / 150	33 lbs.
■S-15110	40 x 20 x 20"		8.02	7.61	7.20	6.79	6.37	10 / 150	42 lbs.
■S-18929 •	40 x 20 x 20"	275 LB. TEST DW	14.25	13.47	12.86	12.25	11.87	5 / 90	34 lbs.
■S-23337	40 x 24 x 12"		8.27	7.90	7.32	6.91	6.46	10 / 150	42 lbs.
■S-16766	40 x 30 x 30"		13.72	13.01	12.28	11.60	10.90	10 / 120	75 lbs.
■S-19776 •	40 x 30 x 30"	275 LB. TEST DW	24.67	23.30	22.28	21.23	20.56	5 / 90	59 lbs.
■S-4967	40 x 30 x 30"	1,100 LB. TW HSC	52.00	50.00	48.00	46.00	45.00	5 / 30	105 lbs.
■S-18973	40 x 40 x 40"	1,100 LB. TW HSC	79.00	75.00	71.00	69.00	67.00	5 / 30	155 lbs.
■S-4683 •	41 x 28 3/4 x 25 1/2"	"E" CNTNR. 275 LB. TEST DW	29.55	28.50	26.95	26.15	25.70	5 / 90	58 lbs.
S-4847	42 x 11 x 6"		4.38	4.15	3.58	3.42	3.13	20 / 240	33 lbs.
■S-11214*	44 x 6 x 35"	FOL, 275 LB. TEST	13.26	11.94	10.58	9.49	8.66	10 / 140	54 lbs.
S-16769	44 x 12 x 12"		4.69	4.37	4.06	3.86	3.52	15 / 150	37 lbs.
■S-16770	46 x 20 x 12"		7.25	6.77	6.48	6.12	5.91	10 / 150	38 lbs.
■S-14247	46 x 38 x 24"	1,300 LB. TW OCTAGON	77.00	72.00	69.00	67.00	66.00	5 / 30	118 lbs.
■S-12707	46 x 38 x 36"	1,300 LB. TW OCTAGON	90.00	86.00	84.00	83.00	82.00	5 / 30	150 lbs.
S-4675	48 x 4 x 4"		2.32	2.11	1.92	1.73	1.69	25 / 625	20 lbs.
S-4940	48 x 6 x 6"		3.36	3.13	2.75	2.57	2.38	25 / 375	32 lbs.
■S-11251*	48 x 6 x 38 - 72"	TELESCOPIC, 275 LB. TEST	20.30	19.10	18.09	16.79	15.56	10 / 120	105 lbs.
S-4574	48 x 8 x 8"		4.27	4.05	3.52	3.32	3.00	20 / 240	32 lbs.
■S-12773*	48 x 8 x 24"	FOL, 275 LB. TEST	13.75	12.42	11.30	10.25	9.32	10 / 140	60 lbs.
S-10666	48 x 10 x 10"		4.56	4.34	3.77	3.56	3.35	20 / 240	47 lbs.
S-19096	48 x 12 x 6"		4.50	4.27	3.74	3.54	3.33	20 / 240	40 lbs.
S-4419	48 x 12 x 12"		3.92	3.92	3.92	3.92	3.92	10 / 240	26 lbs.
S-4941*	48 x 12 x 12"	275 LB. TEST	6.55	6.37	5.82	5.64	5.29	10 / 120	38 lbs.
S-16464 •	48 x 12 x 12"	275 LB. TEST DW	8.28	7.81	7.48	7.12	6.91	10 / 90	40 lbs.
■S-13334	48 x 16 x 16"		7.01	6.56	6.29	5.91	5.75	10 / 120	35 lbs.
■S-20416 •	48 x 16 x 16"	275 LB. TEST DW	12.03	11.29	10.82	10.30	10.01	10 / 90	59 lbs.
■S-22595 •	48 x 20 x 20"	275 LB. TEST DW	15.86	14.90	14.27	13.57	13.21	5 / 90	39 lbs.
■S-19831	48 x 24 x 8"		9.46	8.99	7.85	7.43	6.98	10 / 120	42 lbs.
■S-4848	48 x 24 x 12"		9.21	8.77	8.15	7.63	7.17	10 / 120	47 lbs.
■S-15062 •	48 x 24 x 12"	275 LB. TEST DW	14.72	13.77	13.21	12.60	12.23	5 / 90	36 lbs.
■S-4749	48 x 24 x 24"		10.31	9.62	9.01	8.40	7.69	10 / 120	62 lbs.
■S-14235 •	48 x 24 x 24"	275 LB. TEST DW	19.46	18.28	17.52	16.65	16.19	5 / 90	47 lbs.
■S-18974	48 x 24 x 28"	1,100 LB. TW HSC	50.00	48.00	46.00	45.00	44.00	5 / 30	100 lbs.
■S-18935	48 x 40 x 24"	51 ECT DW HSC	27.70	26.20	25.15	23.60	22.90	5 / 75	64 lbs.
■S-20427	48 x 40 x 24"	1,100 LB. TW HSC	65.00	64.00	62.00	61.00	60.00	5 / 30	125 lbs.
■S-4480	48 x 40 x 36"	51 ECT DW HSC	25.90	25.90	25.90	25.90	25.90	5 / 75	75 lbs.
■S-4812	48 x 40 x 36"	51 ECT DW EASY LOADER	37.00	34.00	33.00	31.00	29.00	5 / 75	75 lbs.
■S-4931	48 x 40 x 36"	1,100 LB. TW HSC	61.00	61.00	61.00	61.00	61.00	5 / 30	150 lbs.
■S-16338	48 x 40 x 36"	1,100 LB. TW RSC	94.00	92.00	86.00	85.00	84.00	5 / 30	200 lbs.
■S-4479	48 x 40 x 36 - 68"	TELESCOPIC	39.00	37.00	35.00	34.00	33.00	5 / 125	85 lbs.
■S-22574	48 x 40 x 48"	51 ECT DW HSC	46.70	43.90	41.45	39.40	37.40	5 / 75	91 lbs.
■S-17996	48 x 40 x 48"	1,100 LB. TW HSC	92.00	87.00	86.00	84.00	83.00	5 / 30	185 lbs.
■S-16337	48 x 48 x 36"	1,100 LB. TW HSC	102.00	100.00	98.00	94.00	93.00	5 / 30	185 lbs.
■S-14246	48 x 48 x 48"	1,100 LB. TW HSC	118.00	115.00	112.00	110.00	105.00	5 / 30	205 lbs.
S-18335	50 x 12 x 12"		5.14	4.83	4.59	4.34	4.18	10 / 240	27 lbs.
■S-4878*	54 x 8 x 28"	FOL, BIKE BOX	16.85	15.24	13.87	12.57	11.45	5 / 125	37 lbs.
■S-10667	54 x 8 x 75"	FULL MATTRESS	20.67	20.06	19.39	18.63	18.05	5 / 125	30 lbs.
■S-15111*	56 x 10 x 32"	FOL, BIKE BOX	20.89	18.82	17.20	15.55	14.18	5 / 125	44 lbs.
■S-4684	58 x 41 x 45"	"D" CNTNR. 350 LB. TEST DW	85.00	83.00	80.00	79.00	77.00	5 / 8	112 lbs.
S-21568	60 x 6 x 6"		3.74	3.52	3.22	3.03	2.94	15 / 360	22 lbs.
S-20536	60 x 8 x 8"		4.95	4.63	4.27	4.05	3.88	15 / 240	30 lbs.
S-21569	60 x 10 x 10"		6.27	5.87	5.42	5.10	4.90	15 / 240	38 lbs.
S-19097	60 x 12 x 12"		7.59	7.10	6.54	6.16	5.89	10 / 240	32 lbs.
S-20417 •	60 x 12 x 12"	275 LB. TEST DW	13.00	12.19	11.24	10.75	10.23	5 / 180	25 lbs.
■S-22598	60 x 24 x 24"		18.37	17.24	15.85	14.94	14.45	10 / 140	72 lbs.
■S-23296 •	60 x 24 x 24"	275 LB. TEST DW	30.41	28.53	26.35	25.28	24.10	5 / 90	57 lbs.
■S-10668	81 x 11 x 40 - 80"	K/Q MATTRESS	38.12	36.95	36.07	35.50	34.81	5 / 125	83 lbs.



# 500 LB. DOUBLE WALL BOXES

Crate-like protection at a corrugated price. Twice as strong as a 275 lb. test double wall box.

- Ship machine parts, small engines and other heavy-duty items.
- UPS recommended weight capacity up to **140 lbs.**



MODEL NO.	INSIDE DIMENSIONS L x W x H	PRICE PER BOX (SOLD IN BUNDLE QTY.)					BUNDLE/BALE QTY.	WT./BNDL.
		10-15	100	250	500	1,000+		
S-18917	16 x 16 x 16"	\$12.60	\$11.83	\$11.10	\$10.41	\$9.67	15 / 75	69 lbs.
■S-18918	20 x 20 x 20"	19.35	18.17	17.11	16.06	15.02	10 / 70	71 lbs.
■S-20991	24 x 24 x 24"	27.80	26.12	24.47	22.87	21.53	10 / 70	101 lbs.

■ SHIPS VIA MOTOR FREIGHT

# RECYCLABLE THERMAL PANELS

Additional insulated products, see pages 50-55.

Insulate cold shipments up to 48 hours in fully recyclable packaging.

- Two-piece design ships and stores flat. 1 1/2" thick.
- Dispose alongside all other paper products in the recycle bin.
- Use with Cold Packs. • Box not included.



MODEL NO.	FITS BOX L x W x H	QTY./CASE	PRICE PER CASE			USE WITH BOX
			1	3	5+	
S-23319	10 x 10 x 10"	15	\$109	\$101	\$97	S-4105
■S-23320	12 x 12 x 12"	15	146	137	130	S-4125
■S-23321	14 x 14 x 14"	10	126	118	112	S-4142

FDA COMPLIANT

■ SHIPS VIA MOTOR FREIGHT

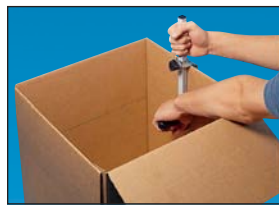

# CARTON SIZER

Reduce boxes to exact size required. Ruled for precise measuring.

- Save Money – No need to maintain excess sizes.
- Save Supplies – Less void fill needed.

MODEL NO.	PRICE EACH		
	1	2	6+
H-101	\$17	\$15	\$13
H-101B	Blade \$3.95 each		

# CARTON STANDS



SINGLE TIER  
H-1073



TWO TIER  
H-1188



WIRE  
H-2080

## FREE OFFERS

**FREE Steel Single Tier**  
H-1073 with any box order of \$750+ upon request.

**FREE Wire Two Tier** with any box order of \$1,500+ upon request.

**FREE Steel Two Tier** H-1188 with any box order of \$1,800+ upon request.

## STEEL

Save space and keep your packing area organized.

- All steel construction provides superior strength.
- Single Tier – 20" dividers.
- Two Tier – Bottom shelf has 20" dividers. Adjustable top shelf has 14" dividers.

## WIRE

Position your boxes exactly where you need them.

- Open wire shelves reduce dust and dirt buildup.
- Adjust shelves in 1" increments.
- 5" polyurethane swivel casters included.

## STEEL

MODEL NO.	DIMENSIONS L x W x H	DESCRIPTION	CAPACITY	PRICE EACH	
				1	2+
H-1073	42 x 18 x 23"	Single Tier	500 lbs.	\$180	\$165
■H-1188	51 x 18 x 58 3/4"	Two Tier		319	299
H-1074	Optional Set of 4 Casters			54	51

■ SHIPS UNASSEMBLED VIA MOTOR FREIGHT

## WIRE

MODEL NO.	DIMENSIONS L x W x H	DESCRIPTION	CAPACITY	PRICE EACH	
				1	2+
H-2080	48 x 18 x 69"	Two Tier	1,000 lbs.	\$290	\$270
H-2081	60 x 18 x 69"			315	295

SHIPS UNASSEMBLED VIA UPS

# 275 LB. DOUBLE WALL BOXES

**PREMIUM**



S-4712



S-4968



S-4958



S-12613

MODEL NO.	INSIDE DIMENSIONS L x W x H	PRICE PER BOX (SOLD IN BUNDLE QTY'S.)					BUNDLE/ BALE QTY.	WT./ BNDL.
		25	100	250	500	1,000+		
S-18180	6 x 6 x 6"	\$1.32	\$1.22	\$1.11	\$1.04	\$1.01	15 / 675	7 lbs.
S-4815	8 x 8 x 8"	1.85	1.70	1.60	1.49	1.42	15 / 450	12 lbs.
S-16515	9 x 9 x 6½"	1.95	1.79	1.65	1.58	1.50	15 / 450	13 lbs.
S-23958	10 x 8 x 8"	2.07	1.90	1.79	1.65	1.59	15 / 450	14 lbs.
S-4953	10 x 10 x 10"	2.68	2.51	2.32	2.17	2.07	15 / 300	18 lbs.
S-19771	12 x 9 x 6"	2.16	2.01	1.88	1.75	1.65	15 / 450	15 lbs.
S-18182	12 x 10 x 10"	2.85	2.67	2.44	2.32	2.18	15 / 300	19 lbs.
S-23959	12 x 12 x 4"	2.53	2.36	2.20	2.05	1.97	15 / 300	18 lbs.
S-14228	12 x 12 x 6"	2.69	2.51	2.33	2.17	2.07	15 / 300	19 lbs.
S-12594	12 x 12 x 8"	2.75	2.60	2.38	2.29	2.17	15 / 300	21 lbs.
S-15036	12 x 12 x 10"	2.95	2.73	2.51	2.38	2.26	15 / 300	23 lbs.
<b>S-4712</b>	<b>12 x 12 x 12"</b>	<b>2.20</b>	<b>2.20</b>	<b>2.20</b>	<b>2.20</b>	<b>2.20</b>	<b>15 / 300</b>	<b>25 lbs.</b>
S-18919	12 x 12 x 16"	3.75	3.52	3.20	3.03	2.92	15 / 150	30 lbs.
S-4936	12½ x 12½ x 15"	3.63	3.34	3.13	2.96	2.76	15 / 150	30 lbs.
S-15037	13 x 13 x 13"	3.58	3.32	3.11	2.95	2.75	15 / 180	30 lbs.
S-18920	14 x 10 x 10"	2.60	2.40	2.29	2.14	2.04	15 / 300	22 lbs.
S-23305	14 x 12 x 12"	3.42	3.14	2.94	2.76	2.61	15 / 180	28 lbs.
S-18183	14 x 14 x 6"	3.09	2.82	2.68	2.53	2.39	15 / 180	24 lbs.
S-18921	14 x 14 x 8"	3.32	3.03	2.90	2.71	2.59	15 / 180	28 lbs.
S-14229	14 x 14 x 10"	3.55	3.23	3.09	2.91	2.73	15 / 180	30 lbs.
<b>S-4786</b>	<b>14 x 14 x 14"</b>	<b>2.93</b>	<b>2.93</b>	<b>2.93</b>	<b>2.93</b>	<b>2.93</b>	<b>15 / 90</b>	<b>35 lbs.</b>
S-15050	15 x 15 x 15"	5.03	4.68	4.34	4.09	3.94	15 / 90	39 lbs.
S-23960	16 x 12 x 6"	2.77	2.59	2.39	2.25	2.14	15 / 180	23 lbs.
S-16517	16 x 12 x 10"	3.35	3.13	2.91	2.71	2.60	15 / 180	27 lbs.
S-4788	16 x 12 x 12"	3.66	3.36	3.14	2.96	2.80	15 / 180	28 lbs.
S-13308	16 x 16 x 8"	4.16	3.86	3.56	3.35	3.21	15 / 180	32 lbs.
S-16518	16 x 16 x 10"	4.50	4.17	3.87	3.64	3.52	15 / 90	36 lbs.
S-11253	16 x 16 x 12"	4.84	4.49	4.16	3.89	3.75	10 / 90	25 lbs.
<b>S-4774</b>	<b>16 x 16 x 16"</b>	<b>4.42</b>	<b>4.42</b>	<b>4.42</b>	<b>4.42</b>	<b>4.42</b>	<b>15 / 90</b>	<b>45 lbs.</b>
S-23315	16 x 16 x 20"	6.66	6.22	5.78	5.46	5.22	15 / 90	50 lbs.
S-19772	18 x 12 x 6"	3.00	2.79	2.60	2.48	2.38	15 / 180	25 lbs.
S-4896	18 x 12 x 8"	3.22	3.00	2.79	2.61	2.53	15 / 180	25 lbs.
S-14230	18 x 12 x 10"	3.56	3.32	3.10	2.90	2.75	15 / 180	28 lbs.
<b>S-4725</b>	<b>18 x 12 x 12"</b>	<b>2.86</b>	<b>2.86</b>	<b>2.86</b>	<b>2.86</b>	<b>2.86</b>	<b>15 / 180</b>	<b>29 lbs.</b>
S-13313	18 x 14 x 12"	4.50	4.17	3.87	3.66	3.52	15 / 180	35 lbs.
S-14231	18 x 14 x 14"	5.03	4.68	4.32	4.07	3.88	15 / 90	40 lbs.
S-14232	18 x 18 x 8"	5.24	4.90	4.55	4.27	4.09	15 / 90	41 lbs.
<b>S-4968</b>	<b>18 x 18 x 12"</b>	<b>4.28</b>	<b>4.28</b>	<b>4.28</b>	<b>4.28</b>	<b>4.28</b>	<b>10 / 90</b>	<b>30 lbs.</b>
<b>S-4731</b>	<b>18 x 18 x 18"</b>	<b>4.89</b>	<b>4.89</b>	<b>4.89</b>	<b>4.89</b>	<b>4.89</b>	<b>10 / 90</b>	<b>36 lbs.</b>
S-11254	18 x 18 x 24"	8.19	7.32	6.94	6.37	6.07	10 / 90	42 lbs.
S-23961	20 x 10 x 10"	3.44	3.20	2.99	2.79	2.67	15 / 180	27 lbs.
S-12603	20 x 12 x 12"	4.59	4.17	3.77	3.46	3.21	15 / 180	35 lbs.
S-18164	20 x 14 x 14"	5.20	4.84	4.50	4.21	4.07	15 / 90	40 lbs.
S-23962	20 x 16 x 8"	4.74	4.43	4.10	3.86	3.71	15 / 180	38 lbs.
S-13317	20 x 16 x 14"	5.88	5.49	5.10	4.79	4.60	15 / 90	45 lbs.
S-4995	20 x 16 x 16"	6.25	5.84	5.43	5.10	4.91	10 / 90	32 lbs.
S-18165	20 x 20 x 10"	6.54	6.09	5.64	5.23	4.93	10 / 90	33 lbs.
S-4996	20 x 20 x 12"	6.97	6.30	5.93	5.46	5.16	10 / 90	36 lbs.
S-13318	20 x 20 x 16"	7.82	7.23	6.74	6.30	6.12	10 / 90	40 lbs.
<b>S-4733</b>	<b>20 x 20 x 20"</b>	<b>6.12</b>	<b>6.12</b>	<b>6.12</b>	<b>6.12</b>	<b>6.12</b>	<b>10 / 90</b>	<b>45 lbs.</b>

■ SHIPS VIA MOTOR FREIGHT

# 275 LB. DOUBLE WALL BOXES



**PREMIUM**

CONTINUED FROM PAGE 32

MODEL NO.	INSIDE DIMENSIONS L x W x H	PRICE PER BOX (SOLD IN BUNDLE QTYS.)					BUNDLE/BALE QTY.	WT./BNDL.
		25	100	250	500	1,000+		
S-18166	22 x 14 x 12"	\$5.16	\$4.79	\$4.47	\$4.16	\$4.01	15 / 90	39 lbs.
S-16458	22 x 18 x 16"	7.40	6.87	6.35	5.95	5.79	10 / 90	39 lbs.
S-20411	22 x 22 x 12"	8.15	7.37	6.94	6.36	6.05	10 / 90	43 lbs.
■S-4798	22 x 22 x 22"	9.74	9.09	8.64	8.07	7.60	10 / 90	53 lbs.
S-23294	24 x 10 x 10"	3.82	3.44	3.25	2.98	2.82	15 / 180	31 lbs.
<b>S-4843</b>	<b>24 x 12 x 12"</b>	<b>3.25</b>	<b>3.25</b>	<b>3.25</b>	<b>3.25</b>	<b>3.25</b>	<b>15 / 180</b>	<b>37 lbs.</b>
S-16459	24 x 14 x 14"	5.86	5.28	5.02	4.58	4.34	10 / 90	30 lbs.
S-18925	24 x 16 x 8"	5.56	5.19	4.83	4.51	4.21	15 / 180	42 lbs.
S-20412	24 x 16 x 12"	6.35	5.82	5.46	5.07	4.76	10 / 90	33 lbs.
S-15041	24 x 16 x 16"	6.98	6.31	5.97	5.49	5.18	10 / 90	36 lbs.
S-23963	24 x 18 x 10"	6.54	5.91	5.61	5.13	4.90	10 / 90	34 lbs.
S-11255	24 x 18 x 12"	6.88	6.18	5.86	5.36	5.07	10 / 90	35 lbs.
S-4958	24 x 18 x 18"	8.19	7.32	6.94	6.37	6.07	10 / 90	42 lbs.
S-4865	24 x 20 x 12"	7.61	6.88	6.48	5.91	5.61	10 / 90	39 lbs.
■S-13326	24 x 20 x 20"	9.55	8.64	8.18	7.50	7.13	10 / 90	48 lbs.
S-18926	24 x 24 x 6"	7.86	7.12	6.75	6.14	5.86	10 / 90	42 lbs.
■S-4910	24 x 24 x 12"	9.31	8.44	7.94	7.28	6.91	10 / 90	48 lbs.
■S-23295	24 x 24 x 14"	10.10	9.34	8.98	8.34	8.02	10 / 90	52 lbs.
■S-22117	24 x 24 x 16"	10.87	10.25	10.00	9.39	9.10	10 / 90	55 lbs.
■S-10657	24 x 24 x 18"	11.39	10.75	10.48	9.84	9.55	10 / 90	56 lbs.
■S-4740	<b>24 x 24 x 24"</b>	<b>7.52</b>	<b>7.52</b>	<b>7.52</b>	<b>7.52</b>	<b>7.52</b>	<b>10 / 90</b>	<b>63 lbs.</b>
■S-14233	24 x 24 x 36"	13.86	13.02	12.63	11.92	11.58	5 / 90	40 lbs.
■S-11256	26 x 20 x 20"	9.74	8.84	8.36	7.69	7.31	10 / 90	51 lbs.
■S-18167	26 x 26 x 12"	11.16	10.55	10.26	9.62	9.39	10 / 90	54 lbs.
■S-4930	26 x 26 x 26"	15.16	14.32	13.93	13.07	12.73	5 / 90	36 lbs.
■S-18168	28 x 18 x 18"	9.19	8.24	7.81	7.21	6.93	10 / 90	46 lbs.
S-23964	30 x 12 x 12"	5.89	5.43	5.23	4.79	4.52	15 / 180	44 lbs.
S-21542	30 x 15 x 15"	7.66	7.21	7.03	6.65	6.44	10 / 90	39 lbs.
■S-4775	30 x 20 x 20"	11.24	10.58	10.30	9.70	9.42	10 / 90	55 lbs.
■S-12613	30 x 24 x 12"	10.42	9.88	9.57	9.01	8.78	10 / 90	54 lbs.
■S-20415	30 x 30 x 16"	14.69	13.89	13.47	12.66	12.36	5 / 90	39 lbs.
■S-4867	30 x 30 x 30"	20.24	19.09	18.57	17.40	16.99	5 / 90	48 lbs.
■S-11257	32 x 24 x 24"	13.02	12.23	11.92	11.26	10.95	5 / 90	36 lbs.
S-11258	36 x 12 x 12"	6.29	5.70	5.39	4.91	4.66	10 / 90	32 lbs.
S-16463	36 x 16 x 16"	8.89	8.34	7.94	7.60	7.31	10 / 90	48 lbs.
■S-21543	36 x 24 x 8"	10.22	9.61	9.15	8.71	8.42	10 / 90	55 lbs.
■S-14234	36 x 24 x 12"	11.47	10.76	10.26	9.79	9.43	5 / 90	30 lbs.
■S-13333	36 x 24 x 24"	14.03	13.18	12.78	12.04	11.69	5 / 90	39 lbs.
■S-18170	36 x 36 x 12"	19.51	18.30	17.52	16.65	16.19	5 / 90	47 lbs.
■S-15061	36 x 36 x 24"	24.25	22.76	21.81	20.72	20.15	5 / 90	59 lbs.
■S-4966	36 x 36 x 36"	31.91	29.92	28.45	27.27	26.46	5 / 90	67 lbs.
■S-18929	40 x 20 x 20"	14.25	13.47	12.86	12.25	11.87	5 / 90	34 lbs.
■S-19776	40 x 30 x 30"	24.67	23.30	22.28	21.23	20.56	5 / 90	59 lbs.
S-16464	48 x 12 x 12"	8.28	7.81	7.48	7.12	6.91	10 / 90	40 lbs.
■S-20416	48 x 16 x 16"	12.03	11.29	10.82	10.30	10.01	10 / 90	59 lbs.
■S-22595	48 x 20 x 20"	15.86	14.90	14.27	13.57	13.21	5 / 90	39 lbs.
■S-15062	48 x 24 x 12"	14.72	13.77	13.21	12.60	12.23	5 / 90	36 lbs.
■S-14235	48 x 24 x 24"	19.46	18.28	17.52	16.65	16.19	5 / 90	47 lbs.
S-20417	60 x 12 x 12"	13.00	12.19	11.24	10.75	10.23	5 / 180	25 lbs.
■S-23296	60 x 24 x 24"	30.41	28.53	26.35	25.28	24.10	5 / 90	57 lbs.



Double the protection of a 200 lb. test box. Protects your heaviest items.

- Use when extra stacking strength is needed.
- UPS recommended weight capacity up to 80 lbs.
- **275 lb. Single Wall** – Extensive selection in box chart, pages 5-30.

**COMPLETE LINE OF 275 LB. DOUBLE WALL BOXES, SEE ULINE.COM**



**500 LB. DW BOXES, SEE PAGE 31**

■ SHIPS VIA MOTOR FREIGHT



# LIGHTWEIGHT 32 ECT BOXES



S-19077



S-19040



S-19070

**ORDER BY 6 PM FOR  
SAME DAY SHIPPING**



**VORNADO®  
DESKTOP FAN**

**FREE OFFER**

Free upon request with any Uline order of \$300 or more.

**LARGER QUANTITIES  
CALL FOR QUOTE**



S-18351

MODEL NO.	INSIDE DIMENSIONS L x W x H	PRICE PER BOX (SOLD IN BNDL. QTYS.)					BUNDLE/BALE QTY.	WT./BNDL.
		25	100	250	500	1,000+		
S-22101	4 x 4 x 4"	\$.23	\$.23	\$.23	\$.23	\$.23	25 / 2500	3 lbs.
S-22102	5 x 5 x 5"	.32	.32	.32	.32	.32	25 / 1800	5 lbs.
S-22103	6 x 4 x 4"	.31	.31	.31	.31	.31	25 / 2000	4 lbs.
S-23286	6 x 5 x 3"	.45	.41	.37	.34	.33	25 / 2000	4 lbs.
S-22104	6 x 6 x 4"	.33	.33	.33	.33	.33	25 / 1800	5 lbs.
S-21014	6 x 6 x 6"	.37	.37	.37	.37	.37	25 / 1800	6 lbs.
S-19039	7 x 7 x 7"	.50	.50	.50	.50	.50	25 / 900	9 lbs.
S-22173	8 x 4 x 4"	.35	.35	.35	.35	.35	25 / 1875	4 lbs.
S-23950	8 x 4 x 8"	.72	.66	.64	.56	.53	25 / 1500	6 lbs.
S-19040	8 x 6 x 4"	.39	.39	.39	.39	.39	25 / 1800	6 lbs.
S-19041	8 x 6 x 6"	.48	.48	.48	.48	.48	25 / 1200	7 lbs.
S-19043	8 x 8 x 4"	.52	.52	.52	.52	.52	25 / 1200	8 lbs.
S-19044	8 x 8 x 6"	.60	.60	.60	.60	.60	25 / 900	9 lbs.
S-18336	8 x 8 x 8"	.53	.53	.53	.53	.53	25 / 900	10 lbs.
S-22174	9 x 6 x 3"	.41	.41	.41	.41	.41	25 / 1800	6 lbs.
S-19864	9 x 6 x 4"	.42	.42	.42	.42	.42	25 / 1800	6 lbs.
S-19865	9 x 6 x 6"	.48	.48	.48	.48	.48	25 / 1200	8 lbs.
S-19867	9 x 7 x 5"	.65	.61	.55	.52	.50	25 / 1200	8 lbs.
S-19059	9 x 9 x 9"	.62	.62	.62	.62	.62	25 / 600	14 lbs.
S-23288	10 x 6 x 2"	.65	.60	.54	.50	.46	25 / 1800	6 lbs.
S-19060	10 x 6 x 4"	.48	.48	.48	.48	.48	25 / 1800	7 lbs.
S-19061	10 x 6 x 6"	.50	.50	.50	.50	.50	25 / 1200	8 lbs.
S-23952	10 x 7 x 2"	.73	.65	.60	.56	.54	25 / 1500	6 lbs.
S-21012	10 x 8 x 4"	.53	.53	.53	.53	.53	25 / 1200	9 lbs.
S-18337	10 x 8 x 6"	.57	.57	.57	.57	.57	25 / 900	10 lbs.
S-19062	10 x 8 x 8"	.59	.59	.59	.59	.59	25 / 900	12 lbs.
S-19857	10 x 10 x 6"	.59	.59	.59	.59	.59	25 / 900	13 lbs.
S-18338	10 x 10 x 10"	.63	.63	.63	.63	.63	25 / 600	16 lbs.
S-23953	11 x 7 x 4"	.77	.68	.64	.58	.55	25 / 1200	8 lbs.
S-19861	12 x 6 x 4"	.50	.50	.50	.50	.50	25 / 1200	8 lbs.
S-19063	12 x 6 x 6"	.52	.52	.52	.52	.52	25 / 1200	9 lbs.
S-23954	12 x 8 x 2"	.82	.75	.64	.60	.56	25 / 1200	8 lbs.
S-19064	12 x 8 x 6"	.59	.59	.59	.59	.59	25 / 900	12 lbs.
S-19065	12 x 8 x 8"	.62	.62	.62	.62	.62	25 / 900	13 lbs.
S-23289	12 x 9 x 3"	.62	.62	.62	.62	.62	25 / 900	10 lbs.
S-19066	12 x 9 x 4"	.63	.63	.63	.63	.63	25 / 900	12 lbs.
S-18339	12 x 9 x 6"	.71	.71	.71	.71	.71	25 / 900	12 lbs.
S-19852	12 x 9 x 9"	.78	.78	.78	.78	.78	25 / 600	15 lbs.
S-19853	12 x 10 x 4"	.73	.73	.73	.73	.73	25 / 900	12 lbs.
S-18340	12 x 10 x 6"	.76	.76	.76	.76	.76	25 / 900	14 lbs.
S-18341	12 x 10 x 8"	.78	.78	.78	.78	.78	25 / 600	15 lbs.
S-19067	12 x 10 x 10"	.79	.79	.79	.79	.79	25 / 600	18 lbs.
S-19068	12 x 12 x 4"	.76	.76	.76	.76	.76	25 / 600	15 lbs.
S-18342	12 x 12 x 6"	.78	.78	.78	.78	.78	25 / 600	17 lbs.
S-18343	12 x 12 x 8"	.87	.87	.87	.87	.87	25 / 600	18 lbs.

# LIGHTWEIGHT 32 ECT BOXES



S-18346



S-18353



S-18343

MODEL NO.	INSIDE DIMENSIONS L x W x H	PRICE PER BOX (SOLD IN BNDL. QTY.)					BUNDLE/BALE QTY.	WT./BNDL.
		25	100	250	500	1,000+		
S-19069	12 x 12 x 10"	\$.94	\$.94	\$.94	\$.94	\$.94	25 / 600	21 lbs.
S-18344	12 x 12 x 12"	.89	.89	.89	.89	.89	25 / 600	22 lbs.
S-23955	13 x 9 x 5"	1.08	.99	.92	.85	.79	25 / 900	12 lbs.
S-19834	13 x 10 x 4"	.76	.76	.76	.76	.76	25 / 900	13 lbs.
S-19070	13 x 13 x 13"	1.18	1.18	1.18	1.18	1.18	25 / 600	27 lbs.
S-23292	14 x 6 x 8"	.90	.80	.72	.71	.69	25 / 900	11 lbs.
S-18345	14 x 10 x 6"	.77	.77	.77	.77	.77	25 / 600	15 lbs.
S-19849	14 x 10 x 8"	.78	.78	.78	.78	.78	25 / 600	17 lbs.
S-18346	14 x 10 x 10"	.87	.87	.87	.87	.87	25 / 600	18 lbs.
S-19854	14 x 12 x 8"	1.03	1.03	1.03	1.03	1.03	25 / 600	20 lbs.
S-19071	14 x 14 x 6"	1.03	1.03	1.03	1.03	1.03	25 / 600	23 lbs.
S-19072	14 x 14 x 10"	1.24	1.24	1.24	1.24	1.24	25 / 600	27 lbs.
S-18347	14 x 14 x 14"	1.39	1.39	1.39	1.39	1.39	25 / 300	30 lbs.
S-23956	15 x 10 x 2"	1.19	1.07	.98	.89	.84	25 / 900	12 lbs.
S-20464	15 x 12 x 10"	1.15	1.15	1.15	1.15	1.15	25 / 300	23 lbs.
S-19073	15 x 15 x 15"	1.55	1.55	1.55	1.55	1.55	25 / 300	36 lbs.
S-20465	16 x 10 x 6"	.80	.80	.80	.80	.80	25 / 600	16 lbs.
S-21023	16 x 12 x 4"	.98	.98	.98	.98	.98	25 / 450	18 lbs.
S-19820	16 x 12 x 6"	.99	.99	.99	.99	.99	25 / 600	20 lbs.
S-18348	16 x 12 x 8"	1.03	1.03	1.03	1.03	1.03	25 / 300	21 lbs.
S-19074	16 x 12 x 10"	1.12	1.12	1.12	1.12	1.12	25 / 300	25 lbs.
S-18349	16 x 12 x 12"	1.19	1.19	1.19	1.19	1.19	25 / 300	25 lbs.
S-18350	16 x 16 x 8"	1.34	1.34	1.34	1.34	1.34	25 / 300	29 lbs.
S-19075	16 x 16 x 10"	1.45	1.45	1.45	1.45	1.45	25 / 300	33 lbs.
S-18351	16 x 16 x 16"	1.74	1.74	1.74	1.74	1.74	25 / 150	38 lbs.
S-18352	18 x 12 x 6"	1.16	1.16	1.16	1.16	1.16	25 / 300	21 lbs.
S-19076	18 x 12 x 8"	1.18	1.18	1.18	1.18	1.18	25 / 300	24 lbs.
S-19842	18 x 12 x 10"	1.22	1.22	1.22	1.22	1.22	25 / 300	25 lbs.
S-18353	18 x 12 x 12"	1.24	1.24	1.24	1.24	1.24	25 / 300	27 lbs.
S-18354	18 x 14 x 12"	1.46	1.46	1.46	1.46	1.46	25 / 300	31 lbs.
S-18356	18 x 18 x 18"	2.13	2.13	2.13	2.13	2.13	20 / 140	38 lbs.
S-19847	20 x 12 x 12"	1.42	1.42	1.42	1.42	1.42	25 / 300	29 lbs.
S-21040	20 x 14 x 6"	1.31	1.31	1.31	1.31	1.31	25 / 300	27 lbs.
S-20471	20 x 14 x 12"	1.62	1.62	1.62	1.62	1.62	25 / 300	34 lbs.
S-21559	20 x 15 x 15"	1.97	1.97	1.97	1.97	1.97	25 / 300	40 lbs.
S-18357	20 x 16 x 14"	1.96	1.96	1.96	1.96	1.96	25 / 300	40 lbs.
S-18358	20 x 20 x 12"	2.20	2.20	2.20	2.20	2.20	20 / 140	38 lbs.
S-18359	20 x 20 x 20"	2.76	2.76	2.76	2.76	2.76	10 / 150	24 lbs.
S-19851	22 x 14 x 12"	1.60	1.60	1.60	1.60	1.60	25 / 300	35 lbs.
S-18360	24 x 12 x 12"	1.51	1.51	1.51	1.51	1.51	25 / 300	32 lbs.
S-20474	24 x 16 x 12"	2.11	2.11	2.11	2.11	2.11	25 / 150	42 lbs.
S-21031	24 x 16 x 16"	2.28	2.28	2.28	2.28	2.28	20 / 140	39 lbs.
S-19818	24 x 18 x 12"	2.26	2.26	2.26	2.26	2.26	20 / 140	38 lbs.
S-19077	24 x 18 x 18"	2.84	2.84	2.84	2.84	2.84	15 / 150	35 lbs.
S-19078	24 x 24 x 24"	4.04	4.04	4.04	4.04	4.04	15 / 150	53 lbs.



## ROLLING TOOL SEAT

### FREE OFFER

Free upon request with any Uline order of \$750 or more.

**COMPLETE LINE,  
SEE ULINE.COM**

Budget friendly for lightweight shipments.

- Ship toys, clothing, towels and other durable items.
- Up to 19% lighter than 200 lb. test.

#### UPS GUIDELINES

SINGLE WALL BOX TYPE	WEIGHT LIMIT
32 ECT	30 LBS.
200 LB. TEST	40 LBS.

■ SHIPS VIA MOTOR FREIGHT

# MULTI-DEPTH BOXES

200 LB. TEST



**UP TO 6 SIZES IN 1 BOX –  
CUT DOWN TO THE  
SIZE YOU NEED**

- Minimize UPS and FedEx® dimensional weight pricing by eliminating empty box space.
- Sides are creased at intervals – Just cut to the creased height needed, fold down and you have a custom-size carton.
- Models S-4420 and S-279 are perfect for mailing reams of paper.



S-279 11¼ x 8¾ x 12"  
12, 10, 8"

\$.99 per box any bundle qty.

MODEL NO.	INSIDE DIM. L x W x H	VARIABLE DEPTHS	PRICE PER BOX (SOLD IN BUNDLE QTYS.)					BUNDLE/BALE QTY.
			25	100	250	500	1,000+	
S-4706	8 x 8 x 8"	8,7,6,5,4"	\$1.23	\$1.04	\$.98	\$.96	\$.90	25 / 900
S-17994	10 x 8 x 8"	8,6,4"	1.34	1.12	1.04	1.02	.96	25 / 500
S-535	10 x 10 x 10"	10,8,6"	1.52	1.42	1.36	1.29	1.23	25 / 500
S-4520	10 x 10 x 12"	12,10,8,6"	1.88	1.79	1.61	1.57	1.44	25 / 500
S-4420	11¼ x 8¾ x 6"	6,4,2"	.77	.77	.77	.77	.77	25 / 500
S-21599*	11¼ x 8¾ x 6"	6,4,2"	.63	.63	.63	.63	.63	25 / 900
S-279	11¼ x 8¾ x 12"	12,10,8"	.99	.99	.99	.99	.99	25 / 500
S-4709	12 x 6 x 6"	6,4,2"	1.24	1.04	.98	.94	.92	25 / 900
S-4421	12 x 9 x 6"	6,4,2"	1.33	1.11	1.05	1.01	.99	25 / 750
S-15034	12 x 10 x 8"	8,6,4"	1.49	1.38	1.22	1.06	1.04	25 / 500
S-4341	12 x 12 x 6"	6,4,2"	1.52	1.40	1.23	1.08	1.05	25 / 500
S-536	12 x 12 x 12"	12,10,8,6"	1.42	1.42	1.42	1.42	1.42	25 / 500
S-4490	12 x 12 x 18"	18,16,14,12,10"	2.20	2.02	1.86	1.75	1.61	25 / 250
S-558	12¼ x 9¼ x 12"	12,10,8,6"	1.79	1.64	1.46	1.37	1.34	25 / 500
S-4754	12½ x 12½ x 6"	6,4,2"	1.81	1.69	1.49	1.40	1.38	25 / 500
S-4562	12½ x 12½ x 12"	12,10,8,6"	2.10	1.88	1.71	1.65	1.52	25 / 250
S-4444	13 x 13 x 13"	13,11,9,7"	2.33	1.96	1.79	1.73	1.69	25 / 500
S-4895	13¼ x 10¼ x 12"	12,10,8,6"	1.96	1.74	1.61	1.57	1.44	25 / 300
S-537	14 x 10 x 10"	10,8,6,4"	1.81	1.69	1.50	1.44	1.40	25 / 500
S-4423	14 x 12 x 6"	6,4,2"	1.03	1.03	1.03	1.03	1.03	25 / 500
S-4424	14 x 12 x 12"	12,10,8,6"	2.36	2.14	1.94	1.79	1.69	25 / 250
S-4531	14 x 14 x 6"	6,5,4,3"	2.04	1.81	1.65	1.49	1.42	25 / 250
S-538	14 x 14 x 14"	14,12,10,8"	2.69	2.44	2.26	2.14	2.02	25 / 250
S-11252	14½ x 8¾ x 6"	6,4,2"	1.44	1.36	1.11	1.05	1.04	25 / 500
S-521	14½ x 8¾ x 12"	12,10,8,6"	1.85	1.70	1.57	1.49	1.42	25 / 500
S-351	15 x 11½ x 6"	6,5,4,3,2,1"	1.58	1.42	1.34	1.25	1.18	25 / 500
S-523	15 x 12 x 12"	12,10,8,6"	2.10	1.85	1.71	1.69	1.58	25 / 250
S-4369	15 x 15 x 15"	15,13,11,9,7"	3.13	2.82	2.64	2.40	2.26	25 / 250
S-4425	16 x 12 x 6"	6,4,2"	2.07	1.85	1.70	1.57	1.42	25 / 250
S-539	16 x 12 x 12"	12,10,8,6"	2.43	2.18	1.97	1.88	1.81	25 / 250
S-4495	16 x 16 x 6"	6,4,2"	2.18	2.02	1.88	1.74	1.61	25 / 250
S-4370	16 x 16 x 16"	16,14,12,10,8"	3.66	3.22	2.99	2.73	2.53	25 / 125
S-4446	17 x 17 x 17"	17,15,13,11"	3.72	3.36	3.14	2.91	2.69	25 / 150
S-4426	17¼ x 11½ x 6"	6,4,2"	2.04	1.81	1.69	1.50	1.39	25 / 250
S-4476	17¼ x 11½ x 12"	12,10,8,6"	1.52	1.52	1.52	1.52	1.52	25 / 250
S-21609*	17¼ x 11½ x 12"	12,10,8,6"	1.29	1.29	1.29	1.29	1.29	25 / 300
S-4427	18 x 12 x 6"	6,4,2"	2.18	1.97	1.81	1.69	1.57	25 / 250
S-540	18 x 12 x 12"	12,10,8,6"	2.32	2.17	2.07	2.02	1.96	25 / 250
S-559	18 x 14½ x 12"	12,10,8,6"	2.76	2.60	2.40	2.26	2.14	25 / 250
S-4793	18 x 18 x 6"	6,4,2"	2.96	2.73	2.59	2.44	2.29	20 / 240

\* 32 ECT



# MULTI-DEPTH BOXES



MODEL NO.	INSIDE DIM. L x W x H	VARIABLE DEPTHS	PRICE PER BOX (SOLD IN BUNDLE QTYS.)					BUNDLE/BALE QTY.
			25	100	250	500	1,000+	
S-4636	18 x 18 x 12"	12,10,8,6"	\$3.54	\$3.32	\$3.13	\$2.99	\$2.76	20 / 120
<b>S-4371</b>	<b>18 x 18 x 18"</b>	<b>18,16,14,12,10"</b>	<b>2.84</b>	<b>2.84</b>	<b>2.84</b>	<b>2.84</b>	<b>2.84</b>	<b>20 / 120</b>
S-22596	19 x 13 x 12"	12,10,8,6"	2.76	2.61	2.43	2.26	2.14	25 / 300
S-12602	20 x 12 x 12"	12,10,8,6"	2.69	2.51	2.38	2.17	2.05	20 / 240
S-4641	20 x 14 x 14"	14,12,10,8"	3.56	3.32	3.14	3.00	2.79	15 / 240
<b>S-4861</b>	<b>20 x 16 x 14"</b>	<b>14,12,10,8"</b>	<b>2.67</b>	<b>2.67</b>	<b>2.67</b>	<b>2.67</b>	<b>2.67</b>	<b>20 / 240</b>
S-4543	20 x 20 x 12"	12,10,8,6"	4.32	4.05	3.86	3.69	3.32	15 / 120
S-4372	20 x 20 x 20"	20,10,8,6"	5.26	4.84	4.51	4.21	3.87	10 / 120
S-11247	20 x 20 x 20"	20,18,16,14,12"	5.26	4.84	4.51	4.21	3.87	10 / 120
■S-4447	22 x 22 x 22"	22,20,18,16"	6.24	5.77	5.50	5.12	4.83	10 / 120
S-4473	24 x 12 x 6"	6,4,2"	2.33	2.17	2.04	1.88	1.73	20 / 240
S-367	24 x 12 x 12"	12,10,8,6"	2.80	2.67	2.49	2.40	2.32	25 / 250
<b>S-4765</b>	<b>24 x 16 x 12"</b>	<b>12,10,8,6"</b>	<b>2.70</b>	<b>2.70</b>	<b>2.70</b>	<b>2.70</b>	<b>2.70</b>	<b>15 / 150</b>
S-4802	24 x 18 x 12"	12,10,8,6"	4.21	3.93	3.69	3.49	3.19	10 / 120
S-12651	24 x 18 x 18"	18,16,14,12,10"	5.86	5.23	4.93	4.38	4.07	15 / 120
S-4449	24 x 24 x 12"	12,10,8,6"	5.10	4.68	4.39	4.14	3.83	10 / 120
■S-4115	24 x 24 x 24"	24,22,20,18,16"	6.98	6.44	6.20	5.60	5.40	15 / 120
S-4573	26 x 18 x 16"	16,14,12,10"	5.43	4.98	4.68	4.34	4.01	10 / 120
<b>S-4507</b>	<b>26 x 20 x 12"</b>	<b>12,10,8,6,4"</b>	<b>3.37</b>	<b>3.37</b>	<b>3.37</b>	<b>3.37</b>	<b>3.37</b>	<b>10 / 120</b>
■S-4451	26 x 26 x 26"	26,24,22,20"	8.81	8.02	7.76	6.97	6.69	10 / 120
■S-4806	28 x 20 x 24"	24,22,20,18,16,14"	7.53	7.17	6.82	6.47	6.05	10 / 120
S-14285	29 x 17 x 9"	9,7,5,3"	4.37	4.17	3.88	3.58	3.36	15 / 150
S-18982	30 x 17 x 16"	16,14,12,10"	5.13	4.72	4.39	4.11	3.89	15 / 150
■S-11248	30 x 24 x 12"	12,10,8,6,4"	6.14	5.56	5.13	4.84	4.50	15 / 120
■S-4373	36 x 36 x 36"	36,24,22,20"	13.02	12.85	12.66	11.82	11.35	5 / 120

**ORDERS SHIP FROM NEAREST ULINE LOCATION**



**S-4507**  
26 x 20 x 12"  
12, 10, 8, 6, 4"  
**\$3.37 per box any bundle qty.**

■ SHIPS VIA MOTOR FREIGHT

# SUPER SHIPPERS

**275 LB. TEST**

Combine smaller boxes into one Super Shipper and **save on UPS costs.**

- **Six different sizes in every box** – Save money and inventory space.
- Sides are creased at intervals – Simply cut to your desired size.
- Extra strong 275 lb. test is **38% stronger** than 200 lb. test.

MODEL NO.	INSIDE DIM. L x W x H	VARIABLE DEPTHS	PRICE PER BOX				BUNDLE/BALE QTY.	WT./BNDL.
			10	100	250	500+		
S-18983	20 x 20 x 20"		\$6.25	\$5.91	\$5.54	\$5.20	10 / 120	42 lbs.
■S-4000	26 x 20 x 20"	20,18,16,14,12,10"	7.23	6.56	6.36	5.71	10 / 120	46 lbs.
■S-4001	30 x 20 x 20"		7.70	7.28	6.94	6.55	10 / 120	50 lbs.
■S-4776	24 x 24 x 24"		9.04	8.42	7.76	7.40	10 / 120	60 lbs.
■S-4509	30 x 24 x 24"	24,22,20,18,16,14"	10.36	9.57	9.19	8.54	10 / 120	65 lbs.
<b>■S-4453</b>	<b>32 x 24 x 24"</b>		<b>7.51</b>	<b>7.51</b>	<b>7.51</b>	<b>7.51</b>	<b>10 / 120</b>	<b>65 lbs.</b>

■ SHIPS VIA MOTOR FREIGHT



**IN STOCK – SHIPS TODAY**

# HEAVY DUTY CORRUGATED PADS



## 275 LB. TEST – SINGLE WALL

SOLD IN BUNDLE QUANTITIES

MODEL NO.	SIZE W x L	PRICE PER PAD				BUNDLE/BALE QTY.	LBS./BNDL.
		10-25	100	250	500+		
S-12647	30 x 40"	\$2.54	\$2.36	\$2.26	\$2.04	25 / 250	35
■S-6206	40 x 48"	3.52	3.21	3.11	2.77	25 / 250	58
■S-11208	48 x 96"	12.57	11.39	10.74	9.47	10 / 250	45

## 275 LB. TEST – DOUBLE WALL

S-12648	24 x 36"	\$2.79	\$2.51	\$2.30	\$2.02	25 / 350	30
S-14368	24 x 48"	3.32	3.11	2.91	2.49	25 / 350	38
S-14369	30 x 40"	3.43	3.21	2.99	2.57	25 / 175	40
S-13335	36 x 36"	3.55	3.33	3.11	2.64	25 / 175	56
■S-11209	36 x 48"	4.72	4.37	4.00	3.43	10 / 180	20
■S-8339	40 x 48"	5.20	4.92	4.47	3.82	10 / 180	25
■S-11210	48 x 48"	6.44	5.77	5.14	4.28	10 / 180	31
■S-14370	48 x 60"	8.12	7.28	6.82	6.07	10 / 180	38
■S-12649	48 x 72"	9.76	8.77	8.12	7.01	10 / 150	46
■S-8340	48 x 96"	12.84	11.62	10.96	9.68	10 / 150	61
■S-20990	60 x 96"	16.07	14.58	13.71	12.13	10 / 180	78

## 1,100 LB. TEST – TRIPLE WALL

■S-13336	36 x 48"	\$13.21	\$12.04	\$11.35	\$9.99	10 / 70	46
■S-11211	40 x 48"	14.70	13.37	12.60	11.10	10 / 70	50
■S-13337	48 x 48"	17.52	15.96	15.01	13.13	10 / 70	61
■S-16334	48 x 72"	26.27	23.89	22.50	19.73	10 / 70	95
■S-11506	48 x 96"	31.52	30.23	28.50	25.00	10 / 70	121

■ SHIPS VIA MOTOR FREIGHT



# PLASTIC CORRUGATED PADS

Reusable plastic pads provide superior protection.

- Resist dirt, grease and water.
- Rigid and durable for long-term use.
- 3/16" thick polypropylene.

SOLD IN BUNDLE QUANTITIES

SPECIFY COLOR: White, Black, Blue, Natural\*, Red\* or Yellow\*

MODEL NO.	SIZE W x L	PRICE PER PAD					BUNDLE/BALE QTY.	LBS./BNDL.
		10	50	100	250	500+		
S-14371	24 x 18"	\$3.60	\$3.50	\$3.40	\$3.20	\$2.90	10 / 800	7
S-13338	24 x 36"	7.50	7.20	6.80	6.40	6.20	10 / 400	13
■S-11311	40 x 48"	15.00	14.20	13.50	12.70	12.00	10 / 200	28
■S-18981	48 x 48"	18.00	17.10	16.20	15.30	14.40	10 / 200	34
■S-11312	48 x 96"	35.40	33.20	32.00	30.10	28.50	10 / 200	65

\* Natural, Red and Yellow only available in 48 x 96" size

■ SHIPS VIA MOTOR FREIGHT



# PALLET TRAYS

Contain and protect paint cans, pails and bagged product.

- Interchangeable – Use as tray or cap on stretch-wrapped pallet.
- Ships flat. Corner tabs lock into place.

SOLD IN BUNDLE QUANTITIES

MODEL NO.	SIZE L x W x H	TEST	PRICE PER TRAY			BUNDLE/BALE QTY.	LBS./BNDL.
			20	100	240+		
S-22184	48 x 40 x 4"	32 ECT	\$6.80	\$6.45	\$6.10	20 / 240	38
S-23300	48 x 40 x 8"		9.00	8.55	7.95	20 / 240	53

SHIPS VIA MOTOR FREIGHT

# LARGE CORRUGATED PADS

200 LB. TEST

- **200 lb. Test – General purpose.**  
Recommended for separating layers on skids or inside packaging.
- **275 lb. Test – Industrial duty.**  
Offers extra strength to separate product layers on skids or in boxes.
- **275 lb. Test Double Wall – Heavy duty.**  
For stacking heavy items and keeping flat items from bending.
- **1,100 lb. Test Triple Wall – Extra heavy duty.**  
Place between layers of heavy machinery and appliances.

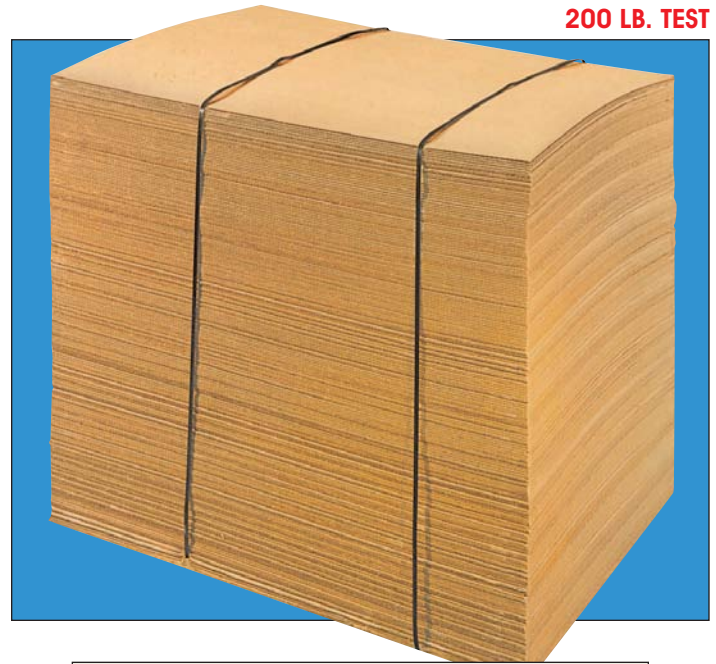

40 x 48" BEST-SELLING SIZE AVAILABLE IN 200 LB., 275 LB., DOUBLE WALL AND TRIPLE WALL

## 200 LB. TEST – SINGLE WALL

MODEL NO.	SIZE W x L	PRICE PER PAD				BUNDLE/BALE QTY.	LBS./BNDL.
		10-50	100	250	500+		
S-9914	15 x 15"	\$.96	\$.84	\$.75	\$.62	50 / 1800	9
S-6378	16 x 12"	.58	.56	.52	.46	50 / 2250	8
S-2630	16 x 16"	1.05	.98	.90	.69	50 / 1500	11
S-11206	18 x 12"	.75	.69	.64	.56	50 / 2000	9
S-19277	18 x 14"	.87	.84	.72	.66	50 / 1500	11
S-2631	18 x 18"	1.17	1.05	.98	.80	50 / 1500	14
S-8283	20 x 12"	1.02	.90	.83	.65	50 / 2000	10
S-15056	20 x 14"	1.04	.96	.90	.69	50 / 1500	12
S-5576	20 x 16"	1.06	1.02	.96	.72	50 / 1000	14
S-3190	20 x 20"	1.34	1.22	1.04	.90	50 / 1000	17
S-5248	20 x 24"	1.38	1.24	1.06	.96	50 / 1000	22
S-12646	20 x 30"	1.50	1.39	1.23	1.04	50 / 600	25
S-19278	22 x 18"	1.25	1.18	1.02	.87	50 / 1000	18
S-3191	22 x 22"	1.39	1.29	1.08	.98	50 / 1000	21
S-14243	22 x 28"	1.50	1.38	1.23	1.04	50 / 500	26
S-13742	24 x 12"	1.06	1.02	.93	.71	50 / 1500	12
S-16512	24 x 16"	1.24	1.17	1.02	.86	50 / 1000	16
S-5577	24 x 18"	1.36	1.23	1.05	.93	50 / 1000	19
S-2633	24 x 24"	1.44	1.36	1.17	.99	50 / 1000	24
S-8285	24 x 30"	1.57	1.42	1.29	1.06	50 / 500	30
S-2483	24 x 36"	1.69	1.50	1.39	1.22	50 / 500	36
S-3192	24 x 48"	1.96	1.81	1.69	1.42	25 / 500	25
S-19279	24 x 60"	2.39	2.25	2.11	1.75	25 / 500	32
S-5249	24 x 72"	2.68	2.53	2.29	1.92	25 / 500	38
S-13743	26 x 26"	1.52	1.39	1.23	1.04	50 / 500	28
S-19280	26 x 38"	1.94	1.70	1.57	1.40	50 / 500	43

SOLD IN BUNDLE QUANTITIES

MODEL NO.	SIZE W x L	PRICE PER PAD				BUNDLE/BALE QTY.	LBS./BNDL.
		10-50	100	250	500+		
S-11207	30 x 30"	\$1.98	\$1.79	\$1.70	\$1.49	50 / 500	39
S-15057	30 x 36"	2.02	1.81	1.71	1.50	25 / 250	23
S-7354	30 x 40"	2.04	1.84	1.73	1.52	25 / 250	25
■S-5578	30 x 72"	3.21	2.98	2.64	2.18	25 / 250	46
S-16513	32 x 32"	2.04	1.84	1.73	1.52	50 / 250	43
S-6379	32 x 48"	2.51	2.32	2.14	1.91	25 / 250	34
S-1160	36 x 36"	2.07	1.88	1.74	1.54	50 / 250	55
S-13744	36 x 42"	2.30	2.11	1.98	1.69	25 / 250	32
■S-321	36 x 48"	2.54	2.36	2.17	1.94	25 / 250	36
■S-16514	36 x 60"	3.49	3.14	2.92	2.39	25 / 250	45
■S-3959	36 x 72"	4.47	4.06	3.67	3.22	25 / 250	55
■S-13745	36 x 96"	5.49	5.08	4.66	4.21	10 / 250	29
S-7355	40 x 40"	2.26	2.11	1.91	1.60	25 / 250	33
■S-1047	40 x 42"	2.38	2.18	1.98	1.69	25 / 250	36
■S-3193	40 x 48"	1.92	1.92	1.92	1.92	25 / 250	42
■S-8284	40 x 60"	3.58	3.22	2.96	2.44	10 / 250	20
■S-6127	42 x 42"	2.75	2.54	2.38	2.02	25 / 250	37
■S-3586	42 x 48"	2.91	2.64	2.49	2.16	25 / 250	43
■S-13746	44 x 44"	2.99	2.77	2.61	2.18	25 / 250	40
■S-355	48 x 48"	3.36	3.03	2.73	2.25	25 / 250	48
■S-3587	48 x 60"	4.22	3.82	3.52	2.85	10 / 250	24
■S-3960	48 x 72"	5.28	4.80	4.48	3.99	10 / 250	30
■S-3194	48 x 96"	4.83	4.83	4.83	4.83	10 / 250	40
■S-19281	60 x 60"	5.51	5.10	4.76	4.15	10 / 250	32
■S-22647	60 x 72"	6.86	6.29	5.94	5.30	10 / 250	38
■S-19282	60 x 96"	9.12	8.38	7.91	7.08	10 / 250	50

■ SHIPS VIA MOTOR FREIGHT



# FANFOLD CORRUGATED

Create custom size boxes for blinds, siding and other hard-to-package items.



CREATE CUSTOM BOXES

- Less expensive than custom size boxes.
- Cut to desired length and wrap around large items.
- Continuous corrugated sheet folded every 48". Ships on a pallet.



SHIPS VIA MOTOR FREIGHT

MODEL NO.	SHEET SIZE W x L	TOTAL LENGTH	TEST	PRICE PER SKID		SHEETS/SKID
				1	5+	
S-16476	40 x 48"	1,000 ft.	200#	\$844	\$759	250
S-20420		600 ft.	275# DW	963	861	150

## SLIP SHEETS

Reduce shipping and storage costs. Use in place of wood pallets for bags of ice melt, dog food or appliances.

- Ultrathin fiberboard sheets weigh 95% less than a wood pallet.
- 3" lip on 2 sides for use with push-pull forklift attachments.

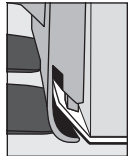

.040 THICK

SOLD IN FULL BALE QUANTITIES

MODEL NO.	SIZE W x L	USABLE DIM. W x L	WEIGHT CAPACITY	SHEETS/BALE	PRICE PER SHEET		LBS./BALE
					500	2,000+	
S-21648	43 x 51"	40 x 48"	2,000 lbs.	500	\$3.00	\$2.60	1,000

SHIPS VIA MOTOR FREIGHT

## ANTI-SLIP PALLET PAPER

Decrease stretch wrap costs and increase load stability.

- Anti-slip, water-resistant, recyclable, non-toxic 75 lb. friction paper.
- Excellent pallet stabilization for bags or cartons.

SHEETS

SHIPS VIA MOTOR FREIGHT

MODEL NO.	SIZE L x W	FITS PALLET	SHEETS/BUNDLE	PRICE PER BUNDLE		LBS./BNDL.
				1	3+	
S-13801	45 x 37"	48 x 40"	100	\$127	\$117	30
S-15272	48 x 40"	48 x 40"		148	133	35



## 32 ECT CORRUGATED PADS

Budget friendly layering sheets for skids.

- Stack and separate layers of lightweight products such as souvenirs from Northern Wisconsin.
- Up to 19% lighter than 200 lb. test pads.



SOLD IN FULL BALE QUANTITIES

MODEL NO.	SIZE W x L	PRICE PER PAD			PADS/BALE	LBS./BALE
		250	500	1,000+		
S-21637	36 x 48"	\$1.64	\$1.64	\$1.64	250	310
S-20457	40 x 48"	1.74	1.74	1.74		340
S-21638	48 x 48"	1.92	1.92	1.92		410
S-20458	48 x 96"	4.35	4.35	4.35		820
S-22600	48 x 120"	5.94	5.94	5.94		1,025

SHIPS VIA MOTOR FREIGHT



# SMALL CORRUGATED PADS

Layer between photos or artwork.

- Use to separate and protect items.

## 150 LB. TEST – SINGLE WALL

SOLD IN BUNDLE QUANTITIES

MODEL NO.	SIZE W x L	PRICE PER PAD				BUNDLE/BALE QTY.	LBS./BNDL.
		50	100	250	500+		
S-18193	5 x 7"	N/A	\$.31	\$.29	\$.23	100 / 13500	3
S-5250	6 x 6"	N/A	.34	.33	.29	100 / 9600	3
S-13339	6 x 9"	N/A	.35	.34	.31	100 / 9000	5
S-18194	7 x 7"	N/A	.35	.34	.31	100 / 9000	4
S-3195	8 x 8"	N/A	.37	.35	.33	100 / 7500	5
S-3961	8 x 10"	N/A	.41	.37	.34	100 / 3200	7
S-2437	8½ x 11"	N/A	.42	.41	.35	100 / 3200	7
S-12890	9 x 9"	N/A	.41	.37	.34	100 / 6000	7
S-3384	9 x 12"	N/A	.52	.48	.45	100 / 4800	9
S-2438	10 x 10"	\$.52	.48	.46	.44	50 / 4000	4
S-12891	10 x 12"	.55	.52	.48	.45	50 / 4800	5
S-18195	10 x 15"	.56	.55	.52	.46	50 / 3000	6
S-3962	11 x 14"	.56	.55	.52	.46	50 / 2400	6
S-3585	11 x 17"	.58	.56	.55	.48	50 / 3000	8



1/8" THICK CORRUGATED PADS

MODEL NO.	SIZE W x L	PRICE PER PAD				BUNDLE/BALE QTY.	LBS./BNDL.
		50	100	250	500+		
S-7352	11½ x 11½"	\$.55	\$.52	\$.48	\$.45	50 / 3000	5
S-2439	12 x 12"	.42	.42	.42	.42	50 / 3000	5
S-18196	13 x 13"	.58	.55	.54	.48	50 / 2250	6
S-18996	13 x 19"	.83	.75	.72	.65	50 / 1500	9
S-2440	14 x 14"	.62	.58	.56	.52	50 / 2250	8

# CHIPBOARD PADS

- Lightweight chipboard pads strengthen envelopes and mailers.
- Provide layers for added protection when stacking in boxes.
- Kraft color, made of recycled paper.

**BEST-SELLING CHIPBOARD PADS AVAILABLE IN THREE THICKNESSES: .022, .030 AND .050**

## .022 THICK

MODEL NO.	SIZE W x L	QTY./CASE	PRICE PER CASE			LBS./CASE
			1	3	5+	
S-14208	5 x 7"	1,125	\$39	\$37	\$35	25
S-22608	5½ x 8½"	925	39	37	35	25
S-16274	8 x 10"	1,050	71	66	59	50
S-6416	8½ x 11"	960	57	57	57	50
S-11307*	8½ x 11"	960	90	84	79	50
S-6417	8½ x 14"	760	71	66	59	50
S-9889	9 x 12"	825	71	66	59	50
S-11308	10 x 10"	800	71	66	59	50
S-14209	11 x 14"	530	71	66	59	50
S-6418	11 x 17"	480	71	66	59	50
S-7909	12 x 12"	625	71	66	59	50
S-18197	12 x 18"	420	71	66	59	50
S-15944	12 x 24"	275	71	66	59	50
S-22609	13 x 19"	350	71	66	59	50
S-18198	14 x 14"	460	71	66	59	50
S-7910	16 x 16"	350	71	66	59	50
S-18199	16 x 20"	275	71	66	59	50
S-11309	18 x 18"	250	69	62	56	50
S-14210	18 x 24"	190	69	62	56	50
S-9886	23 x 35"	111	69	62	56	50
S-6419	26 x 38"	101	69	62	56	50
S-11310	40 x 48"	500	540	515	480	550

\*S-11307 is white on one side

■ SHIPS VIA MOTOR FREIGHT



## .030 THICK

MODEL NO.	SIZE W x L	QTY./CASE	PRICE PER CASE			LBS./CASE
			1	3	5+	
S-8292	8½ x 11"	750	\$72	\$67	\$60	50
S-18200	9 x 12"	640	72	67	60	50
S-8293	11 x 17"	375	72	67	60	50
S-14211	12 x 12"	450	72	67	60	50
S-22610	12 x 18"	310	72	67	60	50
S-8294	26 x 38"	70	70	63	57	50
S-18201	40 x 48"	400	550	525	495	550

■ SHIPS VIA MOTOR FREIGHT

## .050 THICK

S-18997	8½ x 11"	470	\$74	\$68	\$61	50
S-21526	11 x 17"	230	74	68	61	50
S-21527	26 x 38"	40	71	66	59	50
S-18998	40 x 48"	250	570	545	515	550

■ SHIPS VIA MOTOR FREIGHT



## HONEYCOMB PADS

HEAVY DUTY

Package heavier items up to 2,500 lbs. Use flat between pallets.

- Superior cushioning strength for file cabinets, desks and auto parts.
- 100% recyclable.
- Cuts easily with a knife.
- Lightweight but strong enough to reuse.
- Use for blocking, bracing and layering.



MODEL NO.	SHEET SIZE L x W x H	WEIGHT CAPACITY	WEIGHT EACH	QTY./ SKID	PRICE PER SKID		
					1	2	4+
S-16335	40 x 48 x 1/2"	2,500 lbs.	2 lbs.	80	\$566	\$550	\$533
S-12834	40 x 48 x 1"		3 lbs.	40	501	484	466
S-13733	40 x 48 x 2"		5 lbs.	20	466	449	422
S-23326	48 x 48 x 1"		4 lbs.	40	549	529	507
S-18242	48 x 96 x 1/2"	2,500 lbs.	5 lbs.	80	1,118	1,095	1,053
S-23327	48 x 96 x 3/4"		6 lbs.	60	1,257	1,233	1,184
S-15175	48 x 96 x 1"		7 lbs.	40	978	944	903
S-13734	48 x 96 x 2"		10 lbs.	20	884	850	818
S-23328	48 x 96 x 4"		18 lbs.	10	770	738	706

SHIPS VIA MOTOR FREIGHT



## HONEYCOMB PALLET RUNNERS

Eliminate the need for a pallet on your large boxes or bins.

- Lightweight. Adjustable lengths. Perforated every 6 inches.
- Self-adhesive on one side for easy application.
- Compressed paper core blocks provide durability and strength.

MODEL NO.	SIZE L x W x H	WEIGHT CAPACITY	SHPG. WEIGHT	PRICE EACH (MIN. 12)		
				12	24	96+
S-7911	48 x 6 x 4"	1,400 lbs.	2 lbs.	\$13.05	\$12.45	\$11.50



## OCTAGON BULK BINS

Giant 1,300 lb. test triple wall bin stores and ships your heaviest products.

- Recommended for shipping resins, powders and produce.
- Ships complete with a 275 lb. test lid.
- Insert the S-11097 poly liner for maximum protection.



SOLD IN BUNDLE QUANTITIES

MODEL NO.	INSIDE DIM. L x W x H	WEIGHT CAPACITY	TEST	SHPG. WEIGHT	PRICE EACH		BUNDLE/BALE QTY.
					5	25+	
S-14247	46 x 38 x 24"	2,100 lbs.	1,300# TW	24 lbs.	\$80	\$77	5/30
S-12707	46 x 38 x 36"	2,200 lbs.		30 lbs.	93	90	
					PRICE PER ROLL		
S-11097	48 x 40 x 72"	3 Mil Poly Liner (50 Bags/Roll)			1/\$209	2/\$188	5+/\$170

SHIPS VIA MOTOR FREIGHT



# BULK CARGO CONTAINERS



Use to safely transfer bulk products from one site to another.



- Easy to load/unload.
- Protects irregular loads.
- Consolidate several small shipments.
- S-4480T sturdy 200# test lid.
- "EO," "EH" and "E" containers for air cargo shipments.

ONE PALLET INCLUDED PER ORDER (EXCEPT S-4964)

MODEL NO.	DESCRIPTION	INSIDE DIM. L x W x H	TEST	HOLDS MAX. WT.	PRICE EACH (MIN. 5)			ADDITIONAL LIDS (MIN. 5)	
					5	25	100+	MODEL NO.	PRICE EA.
■S-4193	Economy RSC	36 x 36 x 36"	200#	65 lbs.	\$10.53	\$10.53	\$10.53	S-4480T	\$7.20
■S-4966	Premium RSC	36 x 36 x 36"	275# DW	100 lbs.	34.57	31.91	29.92	SHIPS VIA MOTOR FREIGHT	
■S-18935		48 x 40 x 24"			29.65	27.70	26.20		
■S-4480	Gaylord	48 x 40 x 36"	51 ECT DW	100 lbs.	25.90	25.90	25.90		
■S-22574		48 x 40 x 48"			49.85	46.70	43.90		
■S-4681	Heavy Duty RSC	36 x 36 x 24"	600# DW	160 lbs.	53.95	52.05	49.95		
S-4964	"EO" Container	30 x 17 x 17"	350# DW	150 lbs.	13.00	12.50	11.65		
■S-4682*	"EH" Container	36 x 22 x 22"	275# DW	250 lbs.	21.70	21.10	21.00		
■S-4683*	"E" Container	41 x 28¾ x 25½"	275# DW	500 lbs.	30.80	29.55	28.50	■ SHIPS VIA MOTOR FREIGHT * FOL BOTTOM (FULL OVERLAP)	



ADDITIONAL LIDS

**ULINE** EASY LOADER



"Uline uses these boxes daily to ship to our locations from Pleasant Prairie headquarters."  
Dave Field, Uline Transfer Dept. Mgr.

Prevent back strain and other injuries by using this easy-loading Gaylord.

- Perforated 14" from the top on one side.
- When loaded, flap is easily taped back up.
- Heavy-duty double wall ensures safety for your products in shipment.
- Includes lid.

MODEL NO.	INSIDE DIM. L x W x H	TEST	HOLDS MAX. WT.	PRICE EACH (MIN. 5)					WT./ BNDL.	ADDITIONAL LIDS (MIN. 5)	
				5	25	100	250	500+		MODEL NO.	PRICE EA.
S-4812	48 x 40 x 36"	51 ECT DW	100 lbs.	\$39	\$37	\$34	\$33	\$31	75 lbs.	S-4480T	\$7.20

ONE PALLET INCLUDED PER ORDER SHIPS VIA MOTOR FREIGHT

350 LB. TEST DOUBLE WALL



Use to safely transfer bulk product from one site to another.

- Removable front panel for easy loading and unloading.
- Consolidate several small shipments.
- "D" Container – IATA approved. 4 pieces – Includes top and bottom trays and two panels.

MODEL NO.	OUTSIDE DIM. L x W x H	TEST	WEIGHT CAPACITY	SHPG. WT. EACH	PRICE EACH (MIN. 5)		BUNDLE/BALE QTY.
					5	25+	
S-4684	58 x 41 x 45"	350# DW	1,200 lbs.	23 lbs.	\$87	\$85	5/8
H-1618	58 x 41" Heat-Treated Pallet		2,000 lbs.	60 lbs.	69	66	N/A

SHIPS VIA MOTOR FREIGHT



TELESCOPIC

Adjustable 2-piece box accommodates tall or irregular-sized loads.

- Fits load snugly to prevent damage due to shifting.
- Save storage space – Stock fewer box sizes.
- Easily pack several small shipments together.

MODEL NO.	INSIDE DIM. L x W x H	TEST	HOLDS MAX. WT.	PRICE EACH (MIN. 5)					WT./ BNDL.	ADDITIONAL TOPS (MIN. 5)	
				5	25	100	250	500+		MODEL NO.	PRICE EA.
S-15109	36 x 36 x 40 - 76"	200#	65 lbs.	\$33	\$31	\$29	\$28	\$25	72 lbs.	S-15109T	\$18
S-4479	48 x 40 x 36 - 68"			41	39	37	35	34	85 lbs.	S-4479T	20

ONE PALLET INCLUDED PER ORDER SHIPS VIA MOTOR FREIGHT

### 1,100 LB. TRIPLE WALL

Ship heavy items such as small motors, compressors or valves.

- The strength of a plywood crate at the cost of corrugated.
- 1,100 lb. test triple wall corrugated is over 1/2" thick.
- Triple Wall RSC – Super strong one-piece box. No separate lid.

SOLD IN BUNDLE QUANTITIES

MODEL NO.	INSIDE DIM. L x W x H	WEIGHT CAPACITY	TEST	SHPG. WEIGHT	PRICE EACH		BUNDLE/BALE QTY.
					5	25+	
S-11300	36 x 36 x 36"	1,200 lbs.	1,100# TW	25 lbs.	\$60	\$58	5/30
S-4967	40 x 30 x 30"	1,200 lbs.		21 lbs.	54	52	
S-18973	40 x 40 x 40"	1,300 lbs.		31 lbs.	82	79	
S-18974	48 x 24 x 28"	1,200 lbs.		20 lbs.	52	50	
S-20427	48 x 40 x 24"	1,500 lbs.		25 lbs.	66	65	
S-4931	48 x 40 x 36"	1,500 lbs.		30 lbs.	61	61	
S-17996	48 x 40 x 48"	1,500 lbs.		37 lbs.	93	92	
S-16337	48 x 48 x 36"	1,400 lbs.		37 lbs.	104	102	
S-14246	48 x 48 x 48"	1,400 lbs.		41 lbs.	122	118	

SHIPS VIA MOTOR FREIGHT



SHIPS COMPLETE WITH 275 LB. TEST LID

#### TRIPLE WALL RSC

S-13331	24 x 24 x 24"	1,050 lbs.	1,100# TW	14 lbs.	\$37	\$35	5/30
S-11301	30 x 30 x 30"	1,100 lbs.		21 lbs.	55	54	
S-16338	48 x 40 x 36"	1,500 lbs.		40 lbs.	98	94	

SHIPS VIA MOTOR FREIGHT

- Popular 48 x 40" size available in 24", 36" and 48" heights.
- Additional lids, see [uline.com](http://uline.com)

### 1,300 LB. TRIPLE WALL

Reusable container protects products in shipment.

- 1,300 lb. test triple wall side panels for shipping and stacking strength.
- Ships complete with its own attached pallet.
- Certified and marked for export shipments.
- Ships via motor freight.



MODEL NO.	INSIDE DIM. L x W x H	WEIGHT CAPACITY	TEST	SHPG. WEIGHT	PRICE EACH	
					1	5+
S-4874	43 x 36 x 29"	1,900 lbs.	1,300# TW	47 lbs.	\$110	\$100

### 1,100 LB. TRIPLE WALL SLEEVE

Easy packaging and easy storage. Recommended for large items such as generators, AC units or motors.

- Load product on tray, slide sleeve over and place lid on top.
- 1,100 lb. triple wall sides. Ships and stores flat.
- One-piece sleeve with self-locking lid and tray.



SOLD IN BUNDLE QUANTITIES

MODEL NO.	OUTSIDE DIM. L x W x H	WEIGHT CAPACITY	TEST	SHPG. WEIGHT	PRICE EACH		BUNDLE/BALE QTY.
					5	25+	
S-22127	48 x 40 x 36"	1,300 lbs.	1,100# TW	25 lbs.	\$66	\$64	5/30
S-22128	48 x 40 x 48"			31 lbs.	86	84	

SHIPS VIA MOTOR FREIGHT





# PALLET COLLARS

Create a custom-depth crate on your pallet in minutes. Go high or low.

- Recommended for heavy parts or equipment.
- Certified for export.
- 8" tall collars stack easily to your desired height.
- 3/4" wood and steel hinges provide maximum protection.
- Assemble without tools, nails or screws. Folds flat.



**OPTIONAL LID**  
Wooden battens snap in and provide secure fit.



## PALLET COLLARS

MODEL NO.	OUTSIDE DIM. L x W x H	WEIGHT CAPACITY	STACKING STRENGTH	WT. (LBS.)	PRICE PER COLLAR		
					2	6	18+
S-18989	47.24 x 31.5 x 8"	1,250 lbs.	15,000 lbs.	16	\$69	\$67	\$61
S-18394	48 x 40 x 8"			22	74	70	66

SHIPS VIA MOTOR FREIGHT

## OPTIONAL LIDS

MODEL NO.	OUTSIDE DIM. L x W	WT. (LBS.)	PRICE EACH		
			1	5	10+
S-18990	47.24 x 31.5"	15	\$68	\$63	\$57
S-18395	48 x 40"	19	76	71	66

SHIPS VIA MOTOR FREIGHT

# HEAVY DUTY WOOD CRATES

Heavy-duty protection for your most valuable international shipments.

- 3/4" thick plywood.
- Removable front panel for easy loading.
- Quick, no-tool assembly. Steel clips secure panels.
- Export certified. Block pallet included.



MODEL NO.	OUTSIDE DIM. L x W x H	WEIGHT CAPACITY	STACKING STRENGTH	WT. (LBS.)	PRICE EACH		
					1	3	5+
S-18995	36 x 36 x 36"	4,000 lbs.	20,000 lbs.	125	\$490	\$465	\$445
S-20992	48 x 48 x 24"	6,000 lbs.	18,000 lbs.	146	470	445	425
S-18249	48 x 48 x 48"	6,000 lbs.	18,000 lbs.	220	565	535	515
S-20454	48 x 48 x 80"	6,000 lbs.	12,000 lbs.	297	820	780	745
S-18250	96 x 48 x 48"	7,000 lbs.	14,000 lbs.	395	895	850	815
S-23282	96 x 48 x 60"	7,000 lbs.	12,000 lbs.	405	1,080	1,020	990

SHIPS VIA MOTOR FREIGHT

# LARGE WOOD CRATES



MODEL NO.	OUTSIDE DIM. L x W x H	WEIGHT CAPACITY	STACKING STRENGTH	WT. (LBS.)	PRICE EACH		
					1	5	10+
S-15189	60 x 48 x 48"	3,500 lbs.	7,000 lbs.	127	\$404	\$383	\$368
S-24898	60 x 60 x 48"	3,500 lbs.	7,000 lbs.	152	443	421	402
S-24899	60 x 60 x 60"	3,500 lbs.	7,000 lbs.	161	552	522	500
S-12658	67 x 30 x 30"	1,550 lbs.	10,000 lbs.	94	278	261	243
S-21581	72 x 24 x 24"	1,750 lbs.	10,000 lbs.	88	230	212	199
S-22570	72 x 36 x 36"	1,750 lbs.	10,000 lbs.	126	354	321	306
S-14460	72 x 48 x 48"	3,500 lbs.	7,000 lbs.	146	424	401	383
S-22571	84 x 24 x 24"	3,500 lbs.	7,000 lbs.	101	285	266	247
S-15190	84 x 48 x 48"	3,500 lbs.	7,000 lbs.	200	535	506	484

SHIPS VIA MOTOR FREIGHT

# WOOD CRATES



**S-15188**  
WITHOUT PALLET



## STANDARD

"Vault-like" protection for your export shipments.

- Ships flat for easy storage.
- 1/4" thick plywood.
- Assembles in minutes with only a screwdriver.
- Export certified. Meets ISPM 15 requirements.
- Wood pallets heat treated and stamped for export shipment.

MODEL NO.	OUTSIDE DIM. L x W x H	WEIGHT CAPACITY	STACKING STRENGTH	WT. (LBS.)	PRICE EACH		
					1	5	10+
S-18246*	12 x 12 x 12"	250 lbs.	12,000 lbs.	8	\$62	\$57	\$53
S-20434*	18 x 18 x 18"	275 lbs.	12,000 lbs.	15	83	74	70
S-9921*	24 x 20 x 20"	300 lbs.	12,000 lbs.	20	86	79	75
S-20435	24 x 20 x 25"	300 lbs.	12,000 lbs.	29	115	102	98
S-22572*	24 x 24 x 24"	400 lbs.	10,000 lbs.	24	121	105	101
S-13371	24 x 24 x 28 <sup>3</sup> / <sub>4</sub> "	400 lbs.	10,000 lbs.	32	126	116	110
S-18247	30 x 30 x 30"	2,000 lbs.	10,000 lbs.	48	168	160	152
S-16473*	32 x 24 x 24"	500 lbs.	10,000 lbs.	30	139	129	118
S-13372	36 x 22 x 22"	750 lbs.	10,000 lbs.	33	136	125	116
■S-13373	36 x 36 x 36"	2,000 lbs.	10,000 lbs.	63	228	209	197
■S-20436	40 x 40 x 40"	2,750 lbs.	10,000 lbs.	84	275	244	235
■S-11302	41 x 28 <sup>3</sup> / <sub>4</sub> x 25 <sup>1</sup> / <sub>2</sub> "	2,000 lbs.	11,000 lbs.	54	181	167	156
■S-18248*	48 x 30 x 30"	2,250 lbs.	10,000 lbs.	51	184	171	160
■S-16474	48 x 30 x 35"	2,500 lbs.	12,000 lbs.	66	245	227	214
■S-15188*	48 x 40 x 30"	3,000 lbs.	10,000 lbs.	61	209	192	182
■S-9922	48 x 40 x 42"	3,000 lbs.	10,000 lbs.	89	270	248	235
■S-12657	48 x 45 x 35"	2,000 lbs.	12,000 lbs.	98	283	263	247
■S-18994	48 x 48 x 28"	3,000 lbs.	9,000 lbs.	87	266	245	230
■S-11303	48 x 48 x 48"	3,000 lbs.	9,000 lbs.	107	321	304	286
■S-10719	58 x 42 x 46"	3,100 lbs.	8,000 lbs.	130	325	306	289

\* WITHOUT PALLET

■ SHIPS VIA MOTOR FREIGHT



# REUSABLE BULK CONTAINERS



S-19003



S-20451



S-22721

**Corrugated** – Store or ship auto parts, machinery and electrical components. Stack up to 4 high.

- 1,500 lb. test triple wall corrugated sleeve.
- S-20451 has 22" drop-down panel for easy loading.

**Plastic** – Weather-resistant protection for storing or shipping bulk goods and outdoor equipment. Triple-layer polypropylene sleeve with hook and loop to secure 14½" drop-down panel.

- Thermoformed plastic 4-way entry pallet and lid.
- Sliding tabs snap into place securing sleeve, pallet and lid.
- Pallet interlocks with lid to keep stacked containers stable.

Corrugated container has a collapsed height of 12"

Plastic container has a collapsed height of 10"

## CORRUGATED

MODEL NO.	OUTSIDE DIM. L x W x H	WEIGHT CAPACITY	TEST	WT. (LBS.)	SHIPS VIA MOTOR FREIGHT PRICE EACH		
					1	5	10+
S-20450	48 x 40 x 30"	3,500 lbs.	1,500# TW	56	\$245	\$235	\$225
S-19003	48 x 40 x 45"			66	255	245	235
S-20451	48 x 40 x 45"			66	260	250	240

## PLASTIC

MODEL NO.	OUTSIDE DIM. L x W x H	WEIGHT CAPACITY	TEST	WT. (LBS.)	SHIPS VIA MOTOR FREIGHT PRICE EACH		
					1	5	10+
S-22721	48 x 40 x 45"	3,500 lbs.	10 mm	71	\$375	\$355	\$340

# CORRUGATED TRAYS

Transport light loads. Everything from plants to jars and cans.

- Used in nurseries and bottling plants. Move parts in process.
- Ships flat, easy to assemble.

**Craft Beer Tray** – Recommended for 24 standard 12 oz. and 16 oz. aluminum cans.



S-13340  
Multi-Purpose Tray



S-22048  
Craft Beer Tray

MODEL NO.	INSIDE DIM. L x W x H	TEST	PRICE PER TRAY (SOLD IN BUNDLE QTYS.)			BUNDLE/BALE QTY.
			50	100	250+	
S-13340	15 x 12 x 2"	200#	\$.80	\$.72	\$.69	50 / 700
S-22048	15½ x 10⅞ x 2¼"		.84	.77	.72	50 / 1600

# PLASTIC BULK CONTAINERS

Store or ship powders, liquid or metal parts. Reusable, stackable bulk containers with lids cube out trailers.

- Tough polyethylene resists chemicals, corrosion and UV.
- H-1739 – Nest 6 units in 8 feet.
- H-1740 – Nest 4 units in 8 feet.

## FDA COMPLIANT

MODEL NO.	OUTSIDE DIM. L x W x H	CU. FT. CAPACITY	WEIGHT CAPACITY	WT. (LBS.)	SPECIFY COLOR: Blue, Green or Gray PRICE EACH		
					1	3	5+
H-1739	45 x 45 x 33"	27	700 lbs.	95	\$655	\$644	\$633
H-1740	45 x 45 x 44"	35	800 lbs.	118	710	699	688

SHIPS VIA MOTOR FREIGHT





# PELICAN™ EQUIPMENT CASES

Pick N Pluck™ pre-scored foam padding for perfect, customized fit.



World's toughest cases trusted by military and law enforcement personnel.

- Crushproof protection against impact, vibration and shock.
- Lockable latches protect your valuables. • Watertight with a neoprene o-ring.
- Automatic purge valve adjusts for pressure changes.

MODEL NO.	INSIDE DIM. L x W x H	OUTSIDE DIM. L x W x H	PELICAN™ MODEL	SUGGESTED USE	LIFETIME WARRANTY		
					WT. (LBS.)	1	3+
H-6800	9 x 7 x 4"	11 x 10 x 5"	1200	Small Electronics and Parts	3	\$77	\$74
H-6457	12 x 9 x 5"	13 x 12 x 6"	1400		5	147	140
H-7693	15 x 10 x 6"	16 x 13 x 7"	1450		6	177	169
H-6458	17 x 11 x 6"	19 x 14 x 7"	1500	Cameras and Lenses	7	204	192
H-6801*	20 x 11 x 8"	22 x 14 x 9"	1510		14	296	278
H-7694	19 x 14 x 8"	21 x 17 x 8"	1550		12	257	242
H-6459	22 x 17 x 8"	24 x 19 x 9"	1600		14	300	284
H-7695*	22 x 17 x 11"	25 x 20 x 12"	1610	Computers and Equipment	22	393	370
H-7696*	21 x 16 x 13"	25 x 20 x 14"	1620		25	429	404
H-6802*	29 x 18 x 11"	32 x 20 x 12"	1650		28	443	417
H-7697*	28 x 20 x 18"	32 x 23 x 19"	1660		42	595	562
H-10185	50 x 13 x 5"	54 x 16 x 6"	1750	Rifle	26	432	404

\* Wheels and retractable handle



H-10185

**H-6801** – Approved airline carry-on. Sized to fit overhead compartment.

**H-10185** – Wheels and top handle. Solid foam inserts – cut to size.



H-6457



H-6801



S-22219

## THERMAL PALLET COVERS

REFRIGIWEAR®

Protect pallets of frozen food and pharmaceuticals.

- Maintains product temperatures at  $\pm 1^\circ\text{F}$  per hour in hot or cold.
- Machine washable polyester shell with fiberfill insulation.

**Pallet Covers** – Hook and loop strips on all 4 sides. Document pocket holds shipping info.

**Blankets** – Drape over product during staging, loading and unloading.



S-22760

### PALLET COVERS

MODEL NO.	SIZE L x W x H	PADDING	WT. (LBS.)	PRICE EACH		
				1	5	10+
S-22219	48 x 40 x 48"	11.25 oz.	11	\$270	\$260	\$255
S-22759	48 x 40 x 60"		12	310	300	295

### INSULATED BLANKETS

MODEL NO.	SIZE L x W	PADDING	WT. (LBS.)	PRICE EACH		
				1	5	10+
S-22760	72 x 96"	11.25 oz.	6	\$135	\$130	\$125
S-22761	96 x 120"		8	190	180	170

## INSULATED BOX LINERS

Instantly transform any box into an economical insulated thermal shipper.

- Preserves freshness, quality, taste and color. • Leak resistant.
- Space-saving Cool Shield gusseted liners ship and store flat.



- Protects overnight shipments of chocolate or pharmaceuticals.
- Use with Cold Packs for 24 hour shipping.
- Box not included.

FDA COMPLIANT

MODEL NO.	OUTSIDE DIMENSIONS L x W x H	QTY./ CASE	PRICE PER CASE			USE WITH BOX
			1	3	5+	
S-16497	6 x 6 x 6"	25	\$61	\$56	\$54	S-4062
S-15221	8 x 8 x 8"	25	79	74	70	S-4084
S-16498	10 x 10 x 10"	25	114	108	103	S-4105
S-18277*	11 x 8 x 6"	25	87	81	78	S-4607
S-15222	12 x 10 x 9"	25	130	123	118	S-4336
S-18278*	12 x 12 x 6"	25	134	127	121	S-4122
S-15223	12 x 12 x 12"	25	160	147	142	S-4125
S-19757	14 x 10 x 10"	25	149	136	131	S-4144
S-19758	14 x 14 x 14"	15	158	146	141	S-4786
S-21089	16 x 12 x 12"	25	202	190	184	S-4163
S-15224	16 x 16 x 16"	15	186	174	168	S-4774
S-18279	18 x 12 x 12"	25	223	211	205	S-4181
S-19759	18 x 18 x 18"	10	158	146	141	S-4731
S-18280	20 x 20 x 20"	10	191	179	173	S-4733
S-15225	24 x 18 x 18"	10	178	166	161	S-4958

\* Fits USPS Priority Mail Flat Rate Boxes

## DELUXE BOX LINERS

Triple-layer protection for valuable temperature-sensitive shipments.

- Ship meats, seafood and pharmaceuticals with confidence.
- Thick 1" foam cushions and insulates. • Ships and stores flat.
- Use with Cold Packs for up to 48 hour shipping. • Box not included.



FDA COMPLIANT

MODEL NO.	FITS BOX L x W x H	QTY./ CASE	PRICE PER CASE			USE WITH BOX
			1	3	5+	
S-20419	6 x 6 x 6"		\$75	\$69	\$66	S-4062
S-18281	8 x 8 x 8"		100	94	91	S-4084
S-18282	10 x 10 x 10"	20	146	138	134	S-4105
S-18283	12 x 12 x 12"		194	185	178	S-4125
S-19760	14 x 14 x 14"		252	239	230	S-4142
S-21532	16 x 16 x 16"	15	244	231	222	S-4166

## INSULATED MAILERS

Keep chocolates, medicines and perishables cold during transport.

- Thick padded mailers cushion and insulate up to 36 hours.
- Dual closure with leakproof zipper inside and exterior self-seal strip.



1/2" very thick foam with metalized poly exterior

MODEL NO.	OUTSIDE DIMENSIONS W x L	QTY./ CASE	PRICE PER CASE			
			1	3	5	10+
S-22599	7 x 10"		\$59	\$57	\$54	\$51
S-18306	9 x 12"	25	78	74	70	66
S-18307	12 x 16"		110	105	100	95
S-18950	15 x 20"	20	130	124	118	112

# COOL SHIELD BUBBLE ROLLS AND PALLET COVERS



Pallet Cover

- Effective moisture and vapor barrier.
- 3/16" metalized bubble cushions and protects.

**Rolls** – Line pallets or boxes inside or out.

**Pallet Covers** – Encase pallets of perishables for short-term freight shipments. Easily cover top and sides of pallet, then secure with stretch wrap.



Create custom thermal packaging for food, plants and medical shipments.

MODEL NO.	ROLL SIZE	ROLLS/ CASE	PRICE PER ROLL		
			1	3	5+
S-11476	12" x 125'	1	\$54	\$50	\$47
S-18305	16" x 125'		72	68	64
S-12760	24" x 125'		106	99	93
S-9911	48" x 125'		194	183	172
S-19795	60" x 125'		250	233	221
■S-21073	72" x 125'		300	280	266

FDA COMPLIANT

■ SHIPS VIA MOTOR FREIGHT

MODEL NO.	INSIDE DIMENSIONS L x W x H	QTY./ CASE	PRICE PER CASE		
			1	3	5+
S-13375	48 x 40 x 48"	5	\$186	\$175	\$164
S-19796	48 x 40 x 60"		228	217	206
S-21074	48 x 40 x 72"		270	259	248

PALLET COVERS

FDA COMPLIANT

# COOL SHIELD BUBBLE MAILERS



Extra Protection – Use with Uline Easy Seal Side Loaders, pg. 57.

Provide short-term thermal shipping protection for food and pharmaceuticals.

- 3/16" metalized bubble cushions and protects. Self-seal adhesive strips.
- Use with Cold Packs for 24 hour economical shipping.

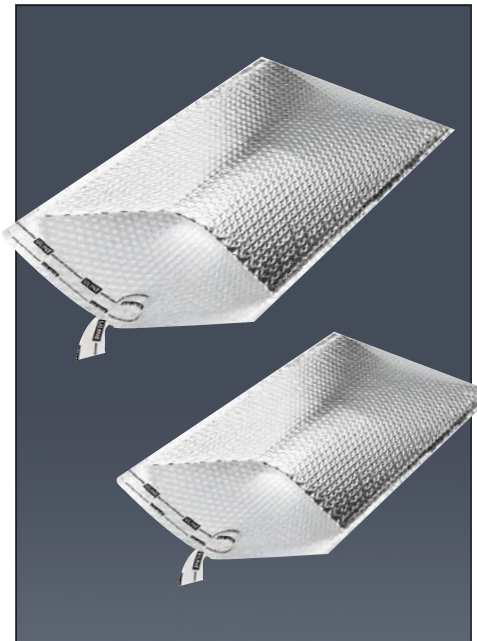

MODEL NO.	INSIDE DIMENSIONS W x L	QTY./ CASE	PRICE PER CASE			USE WITH BOX
			1	3	5+	
S-15216	6 x 6½"	100	\$47	\$42	\$40	–
S-11358	6½ x 10½"		76	69	66	–
S-9908	8 x 11"		81	75	71	S-9715
S-16472	10 x 10½"		100	93	89	–
S-15217	11 x 15"	50	68	63	60	S-7357
S-9909	12 x 17"		78	72	68	–
S-21075	12¾ x 10½"		55	49	46	–
S-13374	15 x 17"		95	87	82	S-7358
S-9910	18 x 22"		123	112	108	–
S-20448	24 x 20"		165	150	144	–

FDA COMPLIANT

# FISH KNIFE



Has glow-in-the-dark skeleton.

- Baked enamel finish and heavy duty steel construction.

MODEL NO.	PRICE EACH
H-906	\$17

**FREE** Upon request with any order of \$300 or more!

Knives, complete line pages 642-645.

# THERMAL GLOVES

LATEX COATED

Thermal acrylic liner keeps hands warm in cold conditions.

- Crinkle finish for excellent "gription."

SPECIFY COLOR: Black or Orange

MODEL NO.	SIZE	QTY./ CTN.	PRICE/CARTON	
			1	2+
S-16857	S, M, L, XL	12 Pair	\$41	\$38







## COLD PACKS

Reusable, leakproof refrigerant gel stays colder than ice.

- Dependable, durable and reusable. Thick 4 mil poly.
- Freeze before use.

FDA COMPLIANT

MODEL NO.	WT.	DIMENSIONS L x W x H	UNITS/CASE	PRICE/CS.		MODEL NO.	WT.	DIMENSIONS L x W x H	UNITS/CASE	PRICE/CS.	
				1	5+					1	5+
S-13376	3 oz.	5 x 2½ x 3/4"	96	\$26	\$24	S-7890	24 oz.	8 x 6 x 1¼"	12	\$17	\$15
S-9902	6 oz.	5½ x 4 x 3/4"	48	23	21	S-14293	32 oz.	8 x 8 x 1½"	9	15	13
S-7361	8 oz.	6 x 4 x 3/4"	36	22	20	S-12761	32 oz.	10 x 6 x 1½"	9	15	13
S-7889	12 oz.	5¼ x 5½ x 1"	24	21	19	S-12762	48 oz.	10¼ x 8 x 1½"	6	13	11
S-7362	16 oz.	6¼ x 6 x 1"	18	20	18						



## SINGLE-USE COLD PACKS

Cost-effective for one way, single-use shipments.

- Standard gel. 3.5 mil poly.
- Keep medicines cool.
- Freeze before use.

MIN. 2 CASES

FDA COMPLIANT

MODEL NO.	WT.	DIMENSIONS L x W x H	UNITS/CASE	PRICE/CS.		MODEL NO.	WT.	DIMENSIONS L x W x H	UNITS/CASE	PRICE/CS.	
				2	5+					2	5+
S-19785	3 oz.	5 x 2½ x 3/4"	96	\$22	\$20	S-18254	24 oz.	8 x 6 x 1¼"	12	\$13	\$11
S-18966	6 oz.	5½ x 4 x 3/4"	48	18	16	S-20426	32 oz.	8 x 8 x 1½"	9	11	9
S-18252	8 oz.	6 x 4 x 3/4"	36	16	14	S-18968	48 oz.	10¼ x 8 x 1½"	6	10	8
S-18967	12 oz.	5¼ x 5½ x 1"	24	15	13	S-22601	64 oz.	11 x 8 x 1½"	4	10	8
S-18253	16 oz.	6¼ x 6 x 1"	18	14	12						



## COLD BRICKS

Foam bricks maintain their shape either frozen or thawed.

- Recommended for tight packaging situations.
- Non-toxic, heavy-duty plastic pouch. 5 mil poly.
- Freeze before use.

FDA COMPLIANT

MODEL NO.	WT.	DIMENSIONS L x W x H	UNITS/CASE	PRICE/CS.		MODEL NO.	WT.	DIMENSIONS L x W x H	UNITS/CASE	PRICE/CS.	
				1	5+					1	5+
S-9905	7.5 oz.	4 x 2¼ x 1½"	48	\$61	\$57	S-9907	30 oz.	9 x 4 x 1½"	6	\$27	\$25
S-14294	7.5 oz.	4½ x 4 x 3/4"	42	58	55	S-12763	64 oz.	9 x 8 x 1½"	6	33	31
S-9906	15 oz.	4½ x 4 x 1½"	12	31	29	S-14296	64 oz.	11¼ x 9¼ x 1"	6	36	34
S-14295	28 oz.	7 x 5 x 1½"	6	25	23						



## MOISTURE-RESISTANT COLD PACKS

Guarantee your pharmaceutical products arrive dry.

- Non-woven 1.5 oz. outer poly cloth absorbs all moisture.
- Reusable, refrigerant gel packs. Multi-use. Leakproof.
- Freeze before use.

FDA COMPLIANT

MODEL NO.	WT.	DIMENSIONS L x W x H	UNITS/CASE	PRICE/CS.		MODEL NO.	WT.	DIMENSIONS L x W x H	UNITS/CASE	PRICE/CS.	
				1	5+					1	5+
S-18969	6 oz.	5½ x 4 x 3/4"	48	\$34	\$32	S-18251	24 oz.	8 x 6 x 1¼"	12	\$24	\$22
S-16494	8 oz.	6 x 4 x 3/4"	36	31	29	S-19786	32 oz.	10 x 6 x 1½"	9	21	19
S-18970	12 oz.	5¼ x 5½ x 1"	24	30	28	S-16496	48 oz.	10¼ x 8 x 1½"	6	19	17
S-16495	16 oz.	6¼ x 6 x 1"	18	27	25						

# ULINE INSULATED SHIPPING KITS



Safely ship everything from food to medical supplies.

- Thick polystyrene foam container provides maximum protection.
- 200 lb. test outer shipping carton included.
- Lightweight, sturdy and reusable.
- Select sizes available as Foam Only, see page 54.



All kits include foam container and shipping box.



MODEL NO.	INSIDE DIM. L x W x H	WALL THICKNESS	OUTSIDE DIM. L x W x H	QTY./CTN.	PRICE PER CARTON		
					1	2	5+
S-7887	6 x 4½ x 3"	1"	8 x 6½ x 5"	8	\$51	\$49	\$47
S-19762	6 x 5 x 4½"	1¼"	8½ x 7½ x 7"	8	62	60	58
S-22602	6 x 5 x 6½"		8½ x 7½ x 9"	8	72	70	67
S-9903	8 x 6 x 4¼"	1½"	11 x 9 x 7¼"	6	50	48	46
S-13391	8 x 6 x 7"		11 x 9 x 10"	4	47	45	42
S-7359	8 x 6 x 9"		11 x 9 x 12"	4	50	48	46
S-11355	8 x 6 x 12"		11 x 9 x 15"	4	57	52	50
S-12682	9¼ x 9¼ x 7"	1¼"	12 x 12 x 9½"	2	28	26	24
S-21090	10¼ x 10¼ x 4½"		12¾ x 12¾ x 6½"	4	55	52	50
S-16478	10½ x 8¼ x 9½"	1½"	13½ x 11¼ x 12½"	2	42	40	37
S-11356	12 x 10 x 5"		15 x 13 x 8"	4	64	62	60
S-15181	12 x 10 x 7"		15 x 13 x 10"	2	45	42	40
S-7360	12 x 10 x 9"		15 x 13 x 12"	2	50	48	46
S-21091	12 x 10 x 15"		15 x 13 x 18"	2	66	64	62
S-13392	12 x 12 x 11½"		2"	16 x 16 x 15½"	1	40	37
S-11357	13 x 13 x 12½"	1½"	16 x 16 x 15½"	1	36	32	30
S-16479	13¾ x 11¾ x 11⅞"	1¼"	16¼ x 14¼ x 14⅞"	1	34	30	28
S-21528	15½ x 12⅝ x 12"	1"	17½ x 14⅝ x 14"	2	66	64	62
S-12683	16¾ x 16¾ x 15"	2"	20¾ x 20¾ x 19"	1	52	50	48
S-12684	17 x 10 x 10½"	1½"	20 x 13 x 13½"	1	32	30	28
S-12685	17 x 17 x 9"		20 x 20 x 12"	1	46	43	41
S-15182	18½ x 13¾ x 19"	1¼"	21¼ x 16½ x 21½"	1	42	40	37
S-7888	19 x 12 x 12½"	1½"	22 x 15 x 15½"	1	49	47	45
S-22603	19 x 12 x 16"		22 x 15 x 19"	1	54	51	47
S-13394	21¼ x 15½ x 15½"	2"	25¼ x 19½ x 19½"	1	59	57	52
S-20422	25 x 16½ x 12"	1½"	28 x 19½ x 15"	1	57	54	50
S-9904	26 x 19¼ x 10½"		29 x 22¼ x 13½"	1	59	57	52
S-19763	30¼ x 14½ x 16"		33¼ x 17½ x 19"	1	64	62	59

# INSULATED FOAM CONTAINERS



Preserve freshness and quality when shipping food or medical supplies.

- Thick, expanded polystyrene foam is lightweight and durable.
- Leak resistant, reliable, reusable and recyclable.
- Snug-fitting lid forms a tight, insulated seal.
- Use with Uline Cold Packs or Bricks, see page 52.

SKID LOTS AVAILABLE, SEE ULINE.COM

MODEL NO.	INSIDE DIM. L x W x H	WALL THICKNESS	OUTSIDE DIM. L x W x H	QTY./ CTN.	PRICE PER CARTON		
					1	2	5+
S-20447	6 x 4½ x 3"	1"	8 x 6½ x 5"	30	\$133	\$129	\$122
S-18312	8 x 6 x 4¼"	1½"	11 x 9 x 7¼"	20	122	118	111
S-21529	8 x 6 x 7"	1½"	11 x 9 x 10"	10	89	85	76
S-18313	8 x 6 x 9"	1½"	11 x 9 x 12"	10	96	91	85
S-21530	8 x 6 x 12"	1½"	11 x 9 x 15"	10	112	107	101
S-22567	9¼ x 9¼ x 7"	1¼"	12 x 12 x 9½"	6	61	56	53
S-18314	12 x 10 x 9"	1½"	15 x 13 x 12"	6	114	110	102
S-22126	12 x 12 x 11½"	2"	16 x 16 x 15½"	3	87	83	77
S-22568	13 x 13 x 12½"	1½"	16 x 16 x 15½"	3	77	72	67



## THERMAL BOX PANELS

Superior insulation with 1½" premium padding protects up to 72 hours.

- Two-piece design ships and stores flat.
- Cushions and insulates pharmaceuticals and food.
- Use with Cold Packs. • Box not included.



FDA COMPLIANT

MODEL NO.	FITS BOX L x W x H	QTY./ CASE	PRICE PER CASE			USE WITH BOX
			1	3	5+	
S-21104	8 x 8 x 8"	20	\$123	\$115	\$111	S-4084
S-21105	10 x 10 x 10"		171	162	155	S-4105
■ S-21106	12 x 12 x 12"		234	224	215	S-4125

■ SHIPS VIA MOTOR FREIGHT



## THERMAL BAGS

Even the pokiest shopper can come home with hot chicken or cold beer.

- Keeps foods hot or cold for up to 3 hours. FDA compliant.
- Snap-lock handles, gusseted bottom. Lightweight and reusable.

MODEL NO.	SIZE W x H x D	WEIGHT CAPACITY	QTY./ CASE	PRICE PER CASE		
				1	3	5+
S-21582	15 x 12 x 6"	20 lbs.	25	\$62	\$60	\$58
S-21583	20 x 20 x 7"	30 lbs.		98	95	91



## ICE PACKS

Use in coolers and ice chests.

- Rigid, puncture-resistant packs.
- Reusable. Non-toxic gel.
- Last for years.

MODEL NO.	DIMENSIONS L x W x H	WEIGHT	QTY./ CASE	PRICE PER CASE	
				1	5+
S-18256	5 x 3 x 1"	8 oz.	24	\$44	\$41
S-18257	7 x 4 x 1½"	16 oz.		72	67
S-18258	7½ x 5¼ x 1½"	32 oz.		110	101



# WINE SHIPPERS



1 CHAMPAGNE OR 1 MAGNUM PACK

1 WINE PACK

12 WINE PACK

Safely ship your wine and champagne bottles with these deluxe, high performance shippers.

- Each shipper includes a polystyrene insert and a 200 lb. test outer carton.
- Ships via UPS.

MODEL NO.	DESCRIPTION	QTY./ BNDL.	SOLD IN BUNDLE QUANTITIES			
			PRICE PER SHIPPER			
			4-5	8-10	20	100+
S-11350	1 Magnum Pack	4	\$9.50	\$8.90	\$8.10	\$7.70
S-19764	2 Magnum Pack	4	11.40	10.90	9.80	9.20
S-6717	1 Champagne Pack	5	7.40	6.80	6.30	5.60
S-19765	6 Champagne Pack	4	20.40	18.80	17.80	16.80
S-11351	12 Champagne Pack	4	27.70	26.60	25.40	24.20

MODEL NO.	DESCRIPTION	QTY./ BNDL.	SOLD IN BUNDLE QUANTITIES			
			PRICE PER SHIPPER			
			4-5	8-10	20	100+
S-5809	1 Wine Bottle Pack	5	\$5.90	\$5.40	\$5.10	\$4.70
S-5810	2 Wine Bottle Pack	5	7.60	6.90	6.50	6.10
S-6715	3 Wine Bottle Pack	4	10.30	9.50	8.60	7.80
S-21002	4 Wine Bottle Pack	4	12.30	11.40	10.20	9.40
S-6716	6 Wine Bottle Pack	4	15.70	14.30	13.30	12.30
S-6518	12 Wine Bottle Pack	4	<b>\$17.00 per shipper any quantity</b>			

# WINE TOTES

Safely carry multiple bottles of wine.

- A carryout tote for stores and wineries.
- Built-in partitions and carrying handle.
- Assembles in seconds – Needs no tape, glue or staples.

200 LB. TEST

MODEL NO.	DESCRIPTION	QTY./ BNDL.	SOLD IN BUNDLE QUANTITIES			
			PRICE PER TOTE			
			25	100	250	500+
S-21610	1 Wine Bottle Tote	25	\$2.30	\$2.10	\$2.00	\$1.90
S-12680	2 Wine Bottle Tote		2.50	2.30	2.20	2.10
S-18289	3 Wine Bottle Tote		3.10	2.90	2.50	2.20
S-10682	4 Wine Bottle Tote		3.30	3.10	2.90	2.30
S-11354	6 Wine Bottle Tote		4.20	3.90	3.70	3.30



# ICE BLANKETS



Flexible liquid filled cells wrap around food or medical products.

- Lightweight, reusable, flexible.
- Does not get wet or soggy.
- Easily cut to desired size.
- Freeze before use.

FDA COMPLIANT

MODEL NO.	SHEET SIZE W x L	CELLS/ SHEET	SHEETS/ CASE	WT. (LBS.)	PRICE PER CASE	
					1	5+
S-16480	17 x 9"	12 x 3	48	50	\$155	\$139
S-16481	17 x 23"	12 x 8	18		151	136
S-16482	17 x 408"	12 x 140	1		144	129

# PULP WINE SHIPPERS



Save space with these molded fiber shippers.

- Nestable – 30 nested trays measure only 25" tall.
- Strong – Meets UPS, FedEx® and ISTA testing requirements.
- Made from recycled paper.
- Each shipper includes trays and 200 lb. test outer carton.



Additional trays, see [uline.com](http://uline.com)

SOLD IN BUNDLE QUANTITIES

MODEL NO.	DESCRIPTION	QTY./ BNDL.	PRICE PER SHIPPER			
			30	60	180	240+
S-24716	1 Wine Bottle Pack	30	\$3.80	\$3.00	\$2.80	\$2.40
S-24717	2 Wine Bottle Pack		4.80	4.30	4.10	3.80
S-11353	3 Wine Bottle Pack		7.10	6.60	6.00	5.60
S-24718	4 Wine Bottle Pack		8.40	7.60	7.00	6.40
S-9916	6 Wine Bottle Pack		11.20	10.00	9.30	8.20
S-9917	12 Wine Bottle Pack		14.80	13.80	13.50	12.20

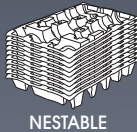

NESTABLE

## CORRUGATED BOTTLE CARRIERS

Safely carry 6 to 24 wine or beer bottles with these heavy-duty corrugated carriers.

- Large hand holes for easy carrying. Ships flat, saves storage space.
- Corrugated inserts accommodate a variety of bottle shapes.

SOLD IN BUNDLE QUANTITIES

MODEL NO.	DESCRIPTION	USABLE CELL DIM.	TEST	QTY./ BNDL.	PRICE PER CARRIER		
					10	40	100+
S-14359	6 Wine Bottle Carrier	3¼ x 3¼ x 12¼"	275# DW	10	\$6.40	\$6.00	\$5.80
S-13343	12 Wine Bottle Carrier	3¼ x 3¼ x 12¼"			12.50	11.70	11.10
S-18290	12 Magnum Bottle Carrier	4¼ x 4¼ x 14"			18.40	16.90	16.00
S-19769	12 Beer Bottle Carrier	2½ x 2½ x 9½"	200#	10	4.80	4.50	4.40
S-14360	24 Beer Bottle Carrier	2½ x 2½ x 9½"	275#		11.80	10.60	10.20



- Carry beer bottles or half-size wine bottles in S-19769 and S-14360.

## RIGID CAN CARRIERS

Premium packaging for specialty beers, sodas and sparkling water.

- No machinery needed. Snaps on, snaps off.
- Covered tops keep cans clean.
- Durable HDPE won't stretch or crack.

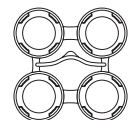

BUILT-IN HANDLE

SPECIFY COLOR: Black Lime Silver

MODEL NO.	DESCRIPTION	CAN SIZE	QTY./ CTN.	LBS./ CTN.	PRICE PER CARTON		
					1	3	12+
S-24159	4-Pack Can Carrier	12 and 16 oz.	788	24	\$195	\$185	\$175
S-24160	6-Pack Can Carrier		510		165	155	145



Craft Beer Tray, see page 48

# WHITE BOXES

200 LB. TEST

MODEL NO.	INSIDE DIMENSIONS L x W x H	PRICE EACH (SOLD IN BUNDLE QTYS.)					BUNDLE/BALE QTY.	LBS./BN DL.
		25	100	250	500	1,000+		
S-4575	4 x 4 x 4"	\$.43	\$.42	\$.41	\$.37	\$.35	25 / 2500	3
S-4948	5 x 5 x 5"	.65	.62	.60	.54	.45	25 / 1800	5
S-18171	6 x 6 x 4"	.90	.75	.66	.65	.61	25 / 1800	6
S-4428	6 x 6 x 6"	.96	.84	.72	.69	.65	25 / 1800	7
S-15028	8 x 6 x 4"	.99	.90	.77	.72	.69	25 / 1800	7
S-4429	8 x 8 x 8"	1.29	1.08	.99	.98	.92	25 / 900	12
S-16454	9 x 9 x 9"	1.40	1.24	1.06	1.04	.99	25 / 600	16
S-14261	10 x 8 x 6"	1.34	1.12	1.04	.99	.93	25 / 900	12
S-4430	10 x 10 x 10"	1.50	1.39	1.17	1.08	1.04	25 / 500	19
S-16455	11 1/4 x 8 3/4 x 4"	1.15	1.04	1.01	.98	.90	25 / 500	12
S-14262	12 x 9 x 4"	1.36	1.23	1.12	1.06	.99	25 / 750	13
S-15033	12 x 10 x 6"	1.58	1.40	1.22	1.12	1.06	25 / 500	17
S-4932	12 x 12 x 6"	1.64	1.49	1.25	1.18	1.11	25 / 500	20
S-13294	12 x 12 x 8"	1.84	1.65	1.42	1.38	1.29	25 / 500	23
S-4431	12 x 12 x 12"	1.99	1.87	1.56	1.47	1.43	25 / 500	27
S-16457	14 x 10 x 10"	1.84	1.64	1.50	1.38	1.32	25 / 500	23
S-4432	14 x 14 x 14"	2.96	2.67	2.43	2.18	2.11	25 / 250	38
S-13303	15 x 12 x 10"	2.38	2.18	2.11	2.02	1.96	25 / 250	28
S-20487	16 x 12 x 12"	2.43	2.26	2.17	2.10	2.04	25 / 300	31
S-4933	16 x 16 x 16"	3.77	3.42	3.13	2.85	2.73	25 / 125	47
S-12599	18 x 12 x 6"	2.40	2.16	2.02	1.92	1.73	25 / 250	25
S-18949	18 x 12 x 8"	2.43	2.21	2.11	2.04	1.95	25 / 250	28
S-4634	18 x 12 x 12"	2.44	2.30	2.18	2.16	2.10	25 / 250	33
S-11262	18 x 18 x 18"	4.63	4.22	4.05	3.83	3.63	20 / 120	48
S-4764	24 x 12 x 12"	3.14	2.96	2.80	2.64	2.44	25 / 250	40
■S-11263	24 x 24 x 24"	7.20	6.79	6.55	6.20	5.84	10 / 120	42

■ SHIPS VIA MOTOR FREIGHT



S-4429

## ULINE EASY SEAL SIDE LOADERS

DELUXE

Uline's version of UPS Next Day Air®, FedEx Express® and USPS Priority Mail boxes.

- Assembles easily without glue or tape. Adhesive strips on both box ends.
- Simple one-piece construction.



TEAR STRIP



SHIPS FLAT TO SAVE SPACE

ADHESIVE STRIP

ULINE'S VERSION OF THE "FedEx" BOX

MODEL NO.	INSIDE DIMENSIONS L x W x H	SIZE	PRICE EACH (SOLD IN BUNDLE QTYS.)					BUNDLE/BALE QTY.
			25	100	250	500	1,000+	
S-9714	9 1/4 x 3 x 6 3/4"	X-Small	\$2.55	\$2.40	\$2.22	\$2.08	\$1.91	25 / 2100
S-7356	10 7/8 x 2 x 12 1/4"	Small	3.21	2.98	2.69	2.54	2.32	25 / 1225
S-9715	11 1/8 x 2 x 8 3/4"	Small	2.80	2.67	2.44	2.29	2.04	25 / 1575
S-7357	11 1/4 x 3 x 15 1/8"	Med.	3.75	3.53	3.32	3.09	2.89	25 / 875
S-7358	12 1/2 x 3 x 17 1/2"	Large	4.21	3.94	3.67	3.45	3.25	25 / 875

## ULINE QUICK CHANGE FOLDING KNIFE

Huge selection of Knives, pages 642-645.



Easily folds to a safe, compact size.

- Metal body with rubber grip. Convenient belt clip. Super fast blade changes.
- Includes 1 blade.

MODEL NO.	PRICE EACH (MIN. 6)				H-64B EXTRA BLADES
	6	12	24	48+	
H-4288	\$8.00	\$7.75	\$7.50	\$7.25	\$18 100/pk.



# HAZARDOUS MATERIALS PACKAGING

Shipper is responsible for selecting appropriate packaging for use with contents. Consult appropriate regulations.



UPS, truck and air approved.

## PAINT CAN SHIPPERS

Easy, economical way to ship your own paint cans.

- Less inventory space – Ships and stores unassembled.
- For use with cans and locking rings, sold on page 59.

MODEL NO.	HOLDS		UN RATING	CARTON SIZE L x W x H	TEST	PRICE EACH		
	QTY.	CAN				10-20	100	200+
S-7449	1		4G/Y2.3/S	4 <sup>5</sup> / <sub>16</sub> x 4 <sup>5</sup> / <sub>16</sub> x 5"	275#	\$2.80	\$2.40	\$2.10
S-7447	2	1 Qt.	4G/Y4.8/S	8 <sup>13</sup> / <sub>16</sub> x 4 <sup>5</sup> / <sub>16</sub> x 5"		3.10	2.50	2.20
S-7448	4		4G/Y9.6/S	8 <sup>13</sup> / <sub>16</sub> x 8 <sup>13</sup> / <sub>16</sub> x 5"		3.30	2.80	2.40
S-7450	1		4G/Y7.5/S	6 <sup>7</sup> / <sub>8</sub> x 6 <sup>7</sup> / <sub>8</sub> x 7 <sup>7</sup> / <sub>8</sub> "	350# DW	3.10	2.50	2.20
S-7452	2	1 Gal.	4G/Y12.5/S	13 <sup>3</sup> / <sub>4</sub> x 6 <sup>7</sup> / <sub>8</sub> x 7 <sup>7</sup> / <sub>8</sub> "		3.40	3.10	2.50
S-7372*	4		4G/Y25.1/S	14 <sup>1</sup> / <sub>4</sub> x 14 <sup>1</sup> / <sub>4</sub> x 7 <sup>7</sup> / <sub>8</sub> "		6.20	5.80	5.20

SOLD IN BUNDLES OF 20

\*10 PER BUNDLE



For Packing Groups I, II and III.

Vermiculite – Grade 4. Inert absorbent recommended for shipping hazardous liquids and chemicals. Additional vermiculite grades, page 780.

## VARIATION 2 SHIPPER KITS

Safely ship solids or liquids in any type of inner container – Bottles, jars, cans.

- Includes carton, liner and tie. Vermiculite sold separately.

MODEL NO.	UN RATING	CARTON SIZE L x W x H	TEST	PRICE PER KIT		
				10-15	45	100+
S-16423	4GV/X2.3/S	6 <sup>3</sup> / <sub>4</sub> x 6 <sup>3</sup> / <sub>4</sub> x 9 <sup>3</sup> / <sub>4</sub> "	275# DW	\$4.30	\$4.10	\$3.90
S-16424	4GV/X3.9/S	7 <sup>7</sup> / <sub>8</sub> x 7 <sup>7</sup> / <sub>8</sub> x 13 <sup>3</sup> / <sub>8</sub> "		5.70	5.40	5.00
S-16425	4GV/X5.1/S	9 <sup>1</sup> / <sub>8</sub> x 9 <sup>1</sup> / <sub>8</sub> x 9 <sup>3</sup> / <sub>4</sub> "		5.80	5.50	5.20
S-18013	4GV/X11.7/S	10 <sup>3</sup> / <sub>4</sub> x 10 <sup>3</sup> / <sub>4</sub> x 15 <sup>3</sup> / <sub>4</sub> "		6.70	6.30	6.10
S-14955	4GV/X13/S	12 x 12 x 12"		6.80	6.40	6.20
S-16426	4GV/X15/S	12 x 12 x 16"		8.30	7.90	7.40
S-20993	4GV/X17/S	12 x 12 x 20"		9.70	9.40	8.40
S-19911	4GV/X17/S	13 x 13 x 13"		7.50	6.80	6.40
S-22742	4GV/X21/S	14 x 14 x 14"		9.20	8.50	8.00
S-14956	4GV/X24.3/S	15 x 15 x 15"		10.80	10.20	9.60
S-20405	4GV/X27.3/S	16 x 16 x 16"	12.40	11.90	11.20	
S-18980*	4GV/X33.4/S	18 x 18 x 18"	15.60	14.60	13.80	
S-22743*	4GV/X36.4/S	19 x 19 x 19"	350# DW	16.50	15.40	14.60
S-14957*	4GV/X39.4/S	20 x 20 x 20"	19.60	18.50	17.40	
S-18015*	4GV/X24.6/S	21 x 11 <sup>3</sup> / <sub>4</sub> x 17 <sup>1</sup> / <sub>4</sub> "	275# DW	11.60	11.00	10.10
S-16427*	4GV/X19/S	24 x 15 x 11"	11.90	11.30	10.50	

SOLD IN KITS OF 15

\*10 PER KIT

### VERMICULITE GRADE 4

Meets ICAA and IATA hazardous materials requirements

MODEL NO.	SIZE	SHIPPING WEIGHT	PRICE EACH (MIN. 2)		
			2	5	10+
S-3393	4 cu. ft. bag	16 lbs.	\$48	\$47	\$46



For Packing Groups I, II and III.

## DUST-FREE VARIATION 2 SHIPPER KITS

Clean, safe, dust-free shipping for solids or liquids in any type of inner container up to 32 oz. – Bottles, jars, cans.

- For use with dyes, chemicals or adhesives in labs and manufacturing.
- Includes carton, inner corrugated support, sorbent pouch, liner and tie.

MODEL NO.	HOLDS		UN RATING	CARTON SIZE L x W x H	TEST	PRICE PER KIT		
	QTY.	SIZE				15	45	90+
S-22146	1	32 oz.	4GV/X3/S	7 <sup>1</sup> / <sub>16</sub> x 7 <sup>1</sup> / <sub>16</sub> x 14 <sup>1</sup> / <sub>4</sub> "	350# DW	\$17	\$16	\$15
S-22147	4		4GV/X10/S	12 <sup>3</sup> / <sub>4</sub> x 12 <sup>3</sup> / <sub>4</sub> x 14 <sup>5</sup> / <sub>8</sub> "	DW	58	55	51

SOLD IN KITS OF 15

# HAZARDOUS MATERIALS PACKAGING

Shipper is responsible for selecting appropriate packaging for use with contents. Consult appropriate regulations.

## PAINT CAN FOAM SHIPPER KITS

The best protection is ensured with these heavy-duty foam shippers.

- Certified for shipping paint, stain and other hazardous materials.
- Ships UPS, truck or international air.

SOLD IN KITS OF 5

MODEL NO.	HOLDS		UN RATING	CARTON SIZE L x W x H	TEST	PRICE PER KIT		
	QTY.	CAN				5	10	20+
S-7347	1	1 Qt.	4G/Y3.2/S	5½ x 5½ x 6"	275#	\$9.40	\$9.00	\$8.65
S-7348	4		4G/Y10.4/S	10% x 10% x 6"		25.50	23.85	22.20
S-7349	1	1 Gal.	4G/Y9.5/S	8½ x 8½ x 9½"	275#	14.25	13.40	12.65
S-7350	2		4G/Y18.8/S	17 x 8½ x 9½"		25.50	23.85	22.20
S-7351	4		4G/Y37.5/S	17 x 17 x 9½"		41.40	39.80	38.20



## BULK PACK SUPPLIES

Save up to 30% by purchasing items separately.

- Ships flat – Save shipping dollars by ordering in volume.
- Stores flat – Save warehouse space.

CARTONS – For use with foam cushioning.

SOLD IN BUNDLES OF 20

MODEL NO.	HOLDS		UN RATING	CARTON SIZE L x W x H	TEST	PRICE EACH		
	QTY.	CAN				10-20	100	200+
S-7335	1	1 Qt.	4G/Y3.2/S	5½ x 5½ x 6"	275#	\$3.20	\$2.80	\$2.60
S-18025	2		4G/Y5.3/S	10% x 5% x 6"		3.30	3.00	2.80
S-7336	4		4G/Y10.4/S	10% x 10% x 6"		3.40	3.20	3.00
S-7337	1	1 Gal.	4G/Y9.5/S	8½ x 8½ x 9½"	275#	3.50	3.30	3.20
S-7338*	2		4G/Y18.8/S	17 x 8½ x 9½"		3.70	3.40	3.30
S-7339*	4		4G/Y37.5/S	17 x 17 x 9½"		5.90	5.40	5.00

\* 10 PER BUNDLE

LOCKING RINGS – Packaged for use in automatic machinery.

MODEL NO.	DESCRIPTION	QTY./CARTON	PRICE PER CARTON		
			1	2	5+
S-7345	For 1 Quart Cans	100	\$75	\$70	\$67
S-7346	For 1 Gallon Cans		88	82	77

FOAM INSERTS

MODEL NO.	DESCRIPTION	QTY./CARTON	PRICE PER CARTON		
			1	2	5+
S-7340	1 Quart	216	\$100	\$90	\$85
■S-7341	1 Gallon	200	175	165	155

■ SHIPS VIA MOTOR FREIGHT

UNLINED CANS

MODEL NO.	DESCRIPTION	QTY./CARTON	PRICE PER CARTON		
			1	3	5+
S-7343	1 Quart Paint	56	\$143	\$138	\$130
S-7342	1 Gallon Paint	34	156	151	144
S-22157	1 Gallon F-Style	40	475	465	455



## 5 GALLON OVERPACK BOXES

NON-UN RATED

Safely ship your UN or Non-UN Rated Pails with extra strong boxes.

- Hand holes provide easy carrying.
- Heavy-duty 275 lb. DW.
- UN Rated containers required when shipping hazardous materials.

SOLD IN BUNDLES OF 15

MODEL NO.	HOLDS		CARTON SIZE L x W x H	TEST	PRICE EACH		
	QTY.	STYLE			15	90	240+
S-18365	1	Pail	12½ x 12½ x 15"	275# DW	\$4.50	\$4.10	\$3.40
S-22648		Jerrican	11¾ x 10½ x 15½"				



Avoid UPS and FedEx® "Additional Handling Charge" for shipping unboxed containers.

# HAZARDOUS MATERIALS PACKAGING

Shipper is responsible for selecting appropriate packaging for use with contents. Consult appropriate regulations.

## F-STYLE SHIPPER KITS



### METAL

Certified for shipping thinners, paints and other solvents.

**Unassembled Kits – Use your own cans.** Includes carton, poly bag and locking tie.

#### UNASSEMBLED WITHOUT CANS

SOLD IN KITS OF 20

MODEL NO.	HOLDS		UN RATING	CARTON SIZE L x W x H	TEST	PRICE PER KIT		
	QTY.	STYLE				20	100	200+
S-20122	1		4G/Y7.4/S	6¾ x 4¾ x 10⅝"	275# DW	\$6.30	\$5.90	\$5.70
S-20123	2	1 Gal.	4G/Y14.8/S	9¾ x 6½ x 10⅝"		8.70	8.10	7.80
S-20124	4		4G/Y28/S	14¾ x 9 x 10⅝"		10.50	10.00	9.50

### PLASTIC

Certified for shipping industrial chemicals, thinners and oils.

**Unassembled Kits – Use your own jugs.** Includes carton, poly bag and locking tie.

#### UNASSEMBLED WITHOUT JUGS

SOLD IN KITS OF 20

MODEL NO.	HOLDS		UN RATING	CARTON SIZE L x W x H	TEST	PRICE PER KIT		
	QTY.	STYLE				20	100	200+
S-18287	1		4G/Y6.1/S	7½ x 4¼ x 12⅝"	275# DW	\$6.80	\$6.10	\$5.80
S-18288	4	1 Gal.	4G/Y24/S	15½ x 9 x 12⅝"		12.50	11.40	10.60

UN Rated for Packing Groups II and III.

## AEROSOL SHIPPERS



Ship aerosol cans via air, ground or water.

- Sturdy corrugated divider holds cans upright and in place.
- Includes carton, liner and dividers. Ships flat, saves space.

SOLD IN KITS OF 15

MODEL NO.	HOLDS		UN RATING	CARTON SIZE L x W x H	TEST	PRICE PER KIT		
	QTY.	CAN				15	30	75+
S-16421	6		4G/Y5.6/S	9⅞ x 6⅞ x 10⅝"	275# DW	\$6.10	\$5.70	\$5.30
S-16422	12	25 oz.	4G/Y11.1/S	12¼ x 9⅞ x 10⅝"		9.10	8.50	7.80

## BATTERY SHIPPERS

### AUTOMOTIVE AND MARINE

Safely ship batteries – wet, filled with acid – by ground or water.

- Includes carton, liner bag and tie.
- Use with Grade 4 Vermiculite, see page 58.

SOLD IN KITS OF 10

MODEL NO.	UN RATING	CARTON SIZE L x W x H	TEST	PRICE PER KIT		
				10	20	50+
S-16428	4G/X31.1/S	17 x 13¼ x 13½"	350# DW	\$11.10	\$10.20	\$9.70

### LITHIUM BATTERIES

Ship lithium batteries or solid hazardous materials by air, ground or water.

- Heavy-duty 275 lb. test DW.
- Must be used with S-396 Anti-Static Bubble, page 740.

Complete line, see [uline.com](http://uline.com)



SOLD IN BUNDLES OF 15

MODEL NO.	UN RATING	CARTON SIZE L x W x H	TEST	PRICE EACH		
				15	45	90+
S-19910	4G/Y25/S	12 x 12 x 12"	275# DW	\$7.90	\$7.20	\$6.90

## 5 GALLON SHIPPERS



**NON-HAZARDOUS**  
For Non-UN Rated Pails  
275 LB. DW  
Unprinted  
See page 617



**HAZARDOUS**  
For UN Rated Pails  
275 LB. DW  
Pre-Printed  
See page 61



**OVERPACK BOXES**  
For UN or Non-UN Rated Containers  
275 LB. DW  
Pre-Printed  
See page 59



# HAZARDOUS MATERIALS PACKAGING

Shipper is responsible for selecting appropriate packaging for use with contents. Consult appropriate regulations.

## PAIL SHIPPERS

Extra strong for safe shipping of hazardous materials.

- Empty pails nest for storage. Recessed lid for easy stacking.
- Steel pail has leakproof rubber gasket to ensure a tight seal.
- Plastic pail has a non-removable lid with easy-pour spout.

**CARTONS** – For use with 5-gallon pails listed below.

**SOLD IN BUNDLES OF 15**

MODEL NO.	HOLDS		UN RATING	CARTON SIZE L x W x H	TEST	PRICE EACH		
	QTY.	STYLE				10-15	100	200+
S-14959	1	Plastic	4G/Y30.8/S	12½ x 12½ x 15"	275# DW	\$6.50	\$6.00	\$5.60
S-7451*		Steel	4G/Y38.5/S	12½ x 12½ x 13⅝"		5.90	5.40	5.00

\* 10 PER BUNDLE

**PAILS**

MODEL NO.	SIZE	UN RATING	STYLE	PRICE EACH		
				5	10	50+
S-14960	5 Gallon	1H2/Y1.5/30	Plastic	\$11.90	\$11.20	\$10.40
S-7344*		1A2/Y2.2/100	Steel	24.10	22.30	21.40

\*SOLD IN CARTONS OF 5



UN Rated for Packing Groups II and III.

## GALLON JUG SHIPPER KITS

Safely ship liquids in 1-gallon plastic jugs via ground or air.

- **Unassembled Kit** – Use your own jugs. Save on warehouse costs. Includes carton, corrugated pads, poly bag and locking tie.
- **Pre-Assembled Kit** – Includes jugs, caps, carton, corrugated pads, poly bag and locking tie.
- Maximum specific gravity per bottle: 1.6.

**UNASSEMBLED WITHOUT JUGS**

**SOLD IN KITS OF 20**

MODEL NO.	HOLDS		UN RATING	CARTON SIZE L x W x H	TEST	PRICE PER KIT		
	QTY.	STYLE				20	100	200+
S-20127	1	1 Gal.	4G/Y6.5/S	6⅝ x 6⅝ x 12⅞"	275# DW	\$7.20	\$6.90	\$6.30
S-20128*	4		4G/Y26/S	12⅝ x 12⅝ x 12⅞"		13.10	12.30	11.50

\*INCLUDES DIVIDER

**PRE-ASSEMBLED**

**SOLD IN KITS OF 5**

MODEL NO.	HOLDS		UN RATING	CARTON SIZE L x W x H	TEST	PRICE PER KIT		
	QTY.	STYLE				5	10	20+
S-20125	1	1 Gal.	4G/Y6.5/S	6⅝ x 6⅝ x 12⅞"	275# DW	\$13.50	\$12.90	\$12.10
S-20126*	4		4G/Y26/S	12⅝ x 12⅝ x 12⅞"		38.90	37.50	36.00

\*INCLUDES DIVIDER



UN Rated for Packing Groups II and III.

## HAZMAT CUBIC YARD BOX

Contain contaminated soils, sludge or asbestos.

- Holds up to 2,500 lbs. of hazardous solid waste.
- Completely incinerable.
- Replaces four 55-gallon drums.
- Box requires pallet for certification.



Includes box, liner, tie and nails to secure box to wooden pallet.

**BOX**

MODEL NO.	UN RATING	CARTON SIZE L x W x H	TEST	PRICE EACH		
				1	5	10+
S-14958	11G/X/USA/2154/1161	36 x 36 x 36"	90 ECT TW	\$133	\$129	\$122

SHIPS VIA MOTOR FREIGHT

**NEW WOOD PALLET**

MODEL NO.	WOOD TYPE	SIZE L x W	CAPACITY (LBS.)	SHIPPING WEIGHT	PRICE EACH (MIN. 5)		
					5	10	20+
H-1814	Heat Treated	42 x 42"	4,000	40 lbs.	\$51	\$50	\$48

SHIPS VIA MOTOR FREIGHT

**UN RATED**



For Packing Groups I, II and III.

# MOVING KITS

IN STOCK – SHIPS TODAY

We've made it easy to order everything you need for moving – Boxes, Tape, Cushioning, Knives and even Markers!

- Simply choose the kit that fits your needs and you're ready to go.



## APARTMENT PACK

1 TO 2 ROOMS

BOXES			SUPPLIES	
20	Medium	18 x 18 x 16"	6	Tape Rolls
15	Large	18 x 18 x 24"	1	Tape Gun
			1	Bubble Roll*
			1	Knife
			1	Marker

Ships via UPS

MODEL NO. S-8081

\$205

## SMALL HOME KIT

2 TO 4 BEDROOMS

BOXES			SUPPLIES	
25	Small	16 x 12 x 12"	6	Tape Rolls
20	Medium	18 x 18 x 16"	1	Tape Gun
15	Large	18 x 18 x 24"	1	Bubble Roll*
			1	Newsprint Bndl.*
			1	Knife
			1	Marker

Ships via UPS

MODEL NO. S-8082

\$298

## DELUXE HOME KIT ■

5 TO 8 BEDROOMS

BOXES			SUPPLIES	
25	Small	16 x 12 x 12"	6	Tape Rolls
40	Medium	18 x 18 x 16"	1	Tape Gun
30	Large	18 x 18 x 24"	2	Bubble Rolls*
5	Wardrobe	24 x 20 x 46"	1	Newsprint Bndl.*
5	Dish Boxes	18 x 18 x 28"	1	Knife
5	Dish Dividers	7 7/8" Tall Partitions	1	Marker

MODEL NO. S-8084 ■

\$605

## ADDITIONAL SUPPLIES

MODEL NO.	DESCRIPTION	MIN.	PRICE EACH
S-638*	24 x 36" Newsprint Sheets	1	\$57 per bundle
S-1012*	12" x 175' Bubble Dispenser	1	\$20 per carton
■S-4750	Wardrobe Boxes	5	\$21.52 each
S-4676	Dish Boxes	5	\$10.15 each
S-2167	Industrial Cast Stretch Wrap	4	\$22 per roll

\* Newsprint: 800 sheets per bundle

\* 12" x 175' roll in dispenser box. 3/16" thick.

■ SHIPS VIA MOTOR FREIGHT

## DELUXE MOVING BOXES



Tabs hold flaps down for hands-free packing.

- Preprinted write-on panel.

### 200 LB. TEST

MODEL NO.	INSIDE DIM. L x W x H	HOLDS CU. FT.	SUGGESTED USE	BNDL. QTY.	SOLD IN BUNDLE QUANTITIES		
					PRICE PER BOX		
					10-25	100	250+
S-14345	16 x 12 x 12"	1.5	Books, candles, tools	25	\$2.17	\$2.01	\$1.88
S-4831	18 x 18 x 16"	3.0	Bulky items	20	3.72	3.42	3.19
S-14346	18 x 18 x 24"	4.5	Lamp shades, clothing	15	4.70	4.32	4.05
S-16378	24 x 18 x 18"	4.5	Clothing, decorations	15	5.07	4.68	4.38
■S-16379	24 x 18 x 24"	6.0	Pillows, towels, linens	10	5.91	5.51	5.14

■ SHIPS VIA MOTOR FREIGHT

## BOXES WITH HAND HOLES



Lift and transport boxes easily.

- Heavy-duty 275 lb. test double wall construction.

### 275 LB. TEST DOUBLE WALL

MODEL NO.	INSIDE DIM. L x W x H	HOLDS CU. FT.	SUGGESTED USE	BNDL. QTY.	SOLD IN BUNDLE QUANTITIES		
					PRICE PER BOX		
					10-15	100	250+
S-16380	18 x 12 x 12"	1.5	Electronics, toys	15	\$4.34	\$3.99	\$3.69
S-15961	18 x 18 x 18"	3.4	Books, tools	10	7.61	6.98	6.54
■S-16381	20 x 20 x 20"	4.6	Linens, appliances	10	9.31	8.59	8.01
S-15063	24 x 12 x 12"	2.0	Kitchen items	15	5.14	4.86	4.38
S-14212	24 x 18 x 18"	4.5	Clothing, decorations	10	8.84	7.94	7.53
■S-14213	24 x 24 x 24"	8.0	Pillows, blankets	10	13.26	12.25	11.45

■ SHIPS VIA MOTOR FREIGHT

# FLAT-PANEL TV BOXES



FITS TVs WITHOUT STANDS

MODEL NO.	INSIDE DIM. L x W x H	FITS TV SIZES	BNDL. QTY.	TEST	PRICE PER BOX (SOLD IN BUNDLE QTYS.)			
					5	100	250	500+
S-16333	22 x 6 x 16"	19 - 22" TVs	5	275# SW	\$4.80	\$4.37	\$4.00	\$3.69
S-16336	28 x 6 x 20"	23 - 26" TVs		275# SW	6.62	6.02	5.52	5.10
■S-15214	38 x 8 x 26"	32 - 37" TVs		275# DW	16.19	14.82	13.69	12.65
■S-13976	46 x 8 x 30"	40 - 46" TVs		350# DW	21.53	19.66	18.15	16.69
■S-13977	56 x 8 x 36"	50 - 55" TVs		350# DW	27.98	25.72	23.67	21.48
■S-15215	64 x 8 x 40"	58 - 65" TVs		600# DW	51.40	47.43	43.56	39.18
■S-19761	70 x 8 x 42"	70 - 75" TVs		600# DW	65.76	60.73	55.71	50.12
■S-23318*	82 x 8 x 50"	75 - 86" TVs		600# DW	99.44	91.94	84.42	76.08

\*Extra large 2-piece telescopic

■ SHIPS VIA MOTOR FREIGHT

Safely ship oversized flat-panel LCD and plasma TVs.

- Sturdy heavy-duty corrugated construction withstands rough handling.
- Full-overlap flaps on top and bottom for extra support.
- Cushion and protect your TV with S-1093 1/4" thick foam, page 777.

# KORRVU® LAPTOP SHIPPER

Protection. Presentation. Space saving.

- Strong, flexible elastomeric film holds electronics firmly in place during shipping.
- Contains 1 retention insert, 200 lb. test outer box and space for accessories.

SOLD IN BUNDLE QUANTITIES

MODEL NO.	INSIDE DIM. L x W x H	FITS LAPTOPS	BNDL. QTY.	PRICE PER BOX		
				5	50	100+
S-16675	18 7/8 x 16 7/8 x 5"	Up to 17"	5	\$13.20	\$12.50	\$11.80



More sizes and Korrvu® Suspension Boxes available, see [uline.com](http://uline.com)

# SPEED PACK

You can do it! Move from a cube to a beautiful corner office with a window.

- Box up entire office. Contents slide through standard doorway.
- Recommended for storing and shipping warehouse parts.
- Use Hardwood Dolly for easy rolling. See page 447.
- Long, skinny Gondola Box also recommended, see page 66.



MODEL NO.	INSIDE DIM. L x W x H	WEIGHT CAPACITY	TEST	SHPG. WEIGHT	PRICE PER BOX			
					5	25	100	250+
S-4967	40 x 30 x 30"	1,200 lbs.	1,100# TW	21 lbs.	\$54	\$52	\$50	\$48

SHIPS VIA MOTOR FREIGHT





# MOVING BOXES

## WARDROBE BOXES



## SUIT SHIPPERS

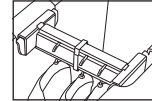

Bar lock secures hangers so garments won't fall off in transit.



- Flat Wardrobe Box S-4965 – Clothes fit while on hanger.

MODEL NO.	INSIDE DIMENSIONS L x W x H	BOX NAME	HOLDS CU. FT.	SUGGESTED USE	BNDL. QTY.	TEST	PRICE PER BOX (SOLD IN BNDL. QTYS.)		
							5	10	30+
<b>WARDROBE BOXES</b>									
■ S-4777	24 x 20 x 34"	UPSable Box	9.5	Clothes hang on 24" bar	5	51 ECT DW	\$15.55	\$15.32	\$13.72
■ S-4750	24 x 20 x 46"	Standard	12.8	Clothes hang on 24" bar			21.52	21.13	19.20
■ S-18044	24 x 22 x 60"	Tall	18.3	Clothes hang on 24" bar			32.84	30.92	29.47
S-4965	36 x 21 x 10"	Flat	4.4	Clothes on hangers	10	200#	N/A	6.65	6.54

■ SHIPS VIA MOTOR FREIGHT

MODEL NO.	INSIDE DIMENSIONS L x W x H	BAR LENGTH	HOLDS CU. FT.	SUGGESTED USE	BNDL. QTY.	TEST	PRICE PER BOX (SOLD IN BNDL. QTYS.)		
							5	25	100+
<b>SUIT SHIPPERS</b>									
S-15178	22 x 4 x 40"	4"	2.0	1-2 Suits	5	275#	\$9.55	\$9.15	\$8.55
S-15179	22 x 8 x 40"	8"	4.1	3-5 Suits		275# DW	13.75	13.00	12.45
■ S-20406	22 x 12 x 40"	12"	6.1	6-8 Suits		275# DW	17.99	17.20	16.30

■ SHIPS VIA MOTOR FREIGHT

## DISH AND GLASS PACK BOXES



- Dish Pack Box S-4676 – Use S-4751 Partitions. Remove 2 center partitions for dishes.



Hand holes for easy carrying.



MODEL NO.	INSIDE DIMENSIONS L x W x H	USABLE CELL DIM. L x W x H	SUGGESTED USE	BNDL. QTY.	TEST	PRICE PER BOX (SOLD IN BNDL. QTYS.)			
						5	25	100+	
<b>DISH PACK BOX</b>									
S-4676	18 x 18 x 28"	4 1/4 x 4 1/4 x 7"	7" Glasses, 8 1/2" Dishes	5	350# DW	\$10.15	\$9.74	\$9.30	
S-4751	Dish Pack Partitions – 3 sets of partitions and 2 pads				200#	18.11	16.52	14.66	
<b>DISH AND GLASS PACK KITS – Includes box and partitions</b>									
S-18940	16 x 12 x 9"	3 3/8 x 3 3/8 x 9"	12 Wine or Pilsner Glasses	5	275#	\$7.88	\$7.31	\$6.82	
S-18941	17 1/2 x 13 x 9 1/4"	4 1/4 x 4 1/4 x 9 1/4"	12 Red Wine Glasses			8.94	8.28	7.76	
S-13273	24 x 12 x 6"	3 3/8 x 3 3/8 x 6"	18 Short Glasses			8.27	7.69	7.21	
S-4972	24 x 12 x 12"	3 3/8 x 3 3/8 x 12"	18 Tall Glasses			11.63	10.79	10.07	
S-12659	26 x 14 x 12"	12 x 12 x 12"	11" Dishes			5	275# DW	16.48	15.08

## PAPER MOVING PADS



Cushion and protect against dust, dirt, minor nicks and scratches during moving.

- Recommended for wood or fragile furniture, pictures and mirrors.
- 3-ply sheets can be taped for a tight fit.

MODEL NO.	SIZE W x L	FILLER	QTY./CASE	SOLD IN CASE QUANTITIES		
				PRICE PER PAD (MIN. 10)		
				10	30	50+
S-18244	48 x 72"	3-Ply	10	\$3.25	\$3.00	\$2.75
S-11304	60 x 72"			3.75	3.50	3.25

# MOVING BOXES

## PACKING/STORAGE BOXES



MODEL NO.	INSIDE DIMENSIONS L x W x H	BOX NAME	HOLDS CU. FT.	SUGGESTED USE	BNDL. QTY.	TEST	PRICE PER BOX (SOLD IN BNDL. QTY.)		
							10-25	100	250+
<b>PACKING BOXES</b>									
S-4163	16 x 12 x 12"	Small	1.5	Books, candles, tools	25		\$1.42	\$1.42	\$1.42
S-4456	18 x 18 x 16"	Medium	3.0	Kitchen items, toys	20		2.40	2.40	2.40
S-4338	18 x 18 x 24"	Large	4.5	Lamp shades, clothing	15	200#	3.05	3.05	3.05
■S-4319	22 x 22 x 22"	X-Large	6.0	Pillows, blankets, towels	10		3.93	3.93	3.93
■S-4474	24 x 24 x 18"	X-Large	6.0	Linens, towels, bulky items	10		5.87	5.44	5.10
<b>STORAGE FILE BOX</b>							25	100	250+
S-6521	15 x 12 x 10"	File w/ Lid	1.0	Letter/Legal	25	200#	\$2.00	\$2.00	\$2.00
<b>CORRUGATED TOTES</b>							25	100	250+
S-7885	19½ x 13 x 10"	Medium Tote	1.1	Supplies	25		\$3.58	\$3.41	\$3.19
■S-7886	25 x 19 x 12"	Large Tote	2.8	Tools/Parts	25	275#	5.71	5.52	5.07



■ SHIPS VIA MOTOR FREIGHT

## MOVING BLANKETS



ECONOMY 25 OZ.

Protect furniture from scratches and scuff marks when moving.

- Oversized 72 x 80" blankets absorb shock.
- Zig-zag stitched padding provides consistent cushioning.

**Camouflage** – Design on both sides.

**Deluxe** – Long-haul movers' favorite with extra padding and heavy-duty stitching.



CAMOUFLAGE 30 OZ.



STANDARD 36 OZ.



DELUXE 38 OZ.

SOLD IN CASE QUANTITIES

MODEL NO.	DESCRIPTION	FILLER/YARD	QTY./CASE	PRICE PER BLANKET (MIN. 6)		
				6	12	24+
S-9878	Economy	25 oz.	6	\$14	\$13	\$12
S-16332	Camouflage	30 oz.	6	18	17	16
S-6082	Standard	36 oz.	6			
S-6083	Deluxe	38 oz.	6	37	36	35

# MOVING BOXES



**SNOWBOARD BOX**  
S-14223



**SKATEBOARD BOX**  
S-14258



**KEYBOARD BOX**  
S-14225



**TENNIS RACQUET BOX**  
S-17999



**ELECTRIC GUITAR BOX**  
S-14224



**GUITAR BOX**  
S-4922

**SURFBOARD BOX**  
TELESCOPIC  
S-14259



SOLD IN BUNDLE QUANTITIES

MODEL NO.	INSIDE DIMENSIONS L x W x H	BOX NAME	HOLDS CU. FT.	SUGGESTED USE	BNDL. QTY.	TEST	PRICE PER BOX		
							5-25	100	250+
<b>SKATEBOARD/SNOWBOARD/SURFBOARD BOXES</b>							5	100	250+
S-14258	33 x 8½ x 5"	Skateboard	0.8	Complete set/multiple decks	25	200#	\$2.17	\$2.05	\$1.96
S-14223*	14 x 4 x 68"	Snowboard	2.2	Snowboard	10	275#	11.37	10.67	9.96
■S-14259*	24 x 8 x 57 - 108"	Surfboard	12	Surfboard	5	275# DW	40.00	39.00	37.00
<b>KEYBOARD BOX</b>							5	100	250+
■S-14225*	20 x 8 x 60"	Keyboard	5.6	Piano Keyboard	5	275#	\$16.27	\$14.91	\$13.83
<b>TENNIS RACQUET BOX</b>							25	100	250+
S-17999*	13 x 3 x 30"	Racquet	0.7	Tennis Racquet	25	200#	\$3.10	\$2.76	\$2.67
<b>GUITAR BOXES</b>							5	100	250+
S-14224*	18 x 6 x 45"	Electric Guitar	2.8	Electric Guitar	5	275#	\$11.01	\$10.35	\$9.62
S-18000*	18 x 7 x 52"	Bass Guitar	3.8	Bass Guitar			12.54	11.80	11.01
S-4922*	20 x 8 x 50"	Guitar	4.6	Guitar			9.71	9.71	9.71

■ SHIPS VIA MOTOR FREIGHT \*FOL = FULL OVERLAP

## JUMBO CARRYING CASES

Send belongings in advance to college, trade shows or conferences.

- Sturdy 275 lb. single-wall corrugated with heavy-duty plastic carrying handle.
- Front locking tabs for added security.
- Reusable. Folds flat for storage.

SOLD IN BUNDLE QUANTITIES

MODEL NO.	OUTSIDE DIMENSIONS L x W x H	MAXIMUM WEIGHT (TAPED)	TEST	PRICE EACH			BUNDLE QTY.
				5	10	25+	
S-16502	22 x 14 x 9"	55 lbs.	275# SW	\$22	\$21	\$20	5
S-16503	26 x 16 x 12"	85 lbs.		28	25	24	

## GONDOLA BOX

EXTRA LONG 49" BOX

Move large artwork, computers and all your office stuff with ease.

- Narrow width fits down hallways without blocking passage. Holds 13.6 cu. ft.

SOLD IN BUNDLE QUANTITIES

MODEL NO.	INSIDE DIMENSIONS L x W x H	WEIGHT CAPACITY	TEST	SHPG. WEIGHT	PRICE PER BOX			BUNDLE QTY.
					5	25	100+	
■S-18975	49 x 20 x 24"	1,200 lbs.	1,100# TW	13 lbs.	\$42.70	\$41.35	\$40.10	5
S-18975T	Optional 275 lb. Test Lid for Gondola Box (min. 5) - \$6.15 each							

■ SHIPS VIA MOTOR FREIGHT



# MOVING BOXES

IN STOCK – SHIPS TODAY



MODEL NO.	INSIDE DIMENSIONS L x W x H	BOX NAME	HOLDS CU. FT.	SUGGESTED USE	BNDL. QTY.	TEST	PRICE PER BOX		
							10-15	100	250+
<b>ELECTRONICS BOXES</b>							10-15	100	250+
S-4210	20 x 20 x 12"	VCR/CD	2.8	VCR or CD Player	15	200#	\$2.58	\$2.58	\$2.58
S-4320	24 x 24 x 12"	Stereo	4.0	Stereo, Speakers	10		3.44	3.44	3.44
<b>GOLF BOXES</b>							10-25	100	250+
S-4465	4 x 4 x 48"	Golf Club	0.5	1 Golf Club	25		\$1.62	\$1.62	\$1.62
S-4606	10 x 10 x 48"	Golf Clubs	2.8	3-4 Golf Clubs	20	200#	4.86	4.59	4.01
■S-4720	15 x 15 x 48"	Golf Bag	6.25	1 Bag of Golf Clubs	10		5.49	5.14	4.86
<b>LAMP BOXES</b>							10-15	100	250+
S-4618	12 x 12 x 40"	Floor Lamp	3.3	Short Lamp Base and Shade	15		\$4.32	\$3.99	\$3.72
S-4525	12 x 12 x 48"	Floor Lamp	4.0	Tall Lamp Base and Shade	15	200#	3.49	3.49	3.49
S-4412	15 x 15 x 30"	Lamp Base	3.9	Lamp Base	15		3.88	3.55	3.30
■S-4569	20 x 20 x 36"	Table Lamp	8.3	Table Lamp and Shade	10		6.94	6.56	5.66
<b>BIKE BOXES</b>							5	100	250+
■S-4878*	54 x 8 x 28"	Bike Box	7.0	Bicycle	5	275#	\$16.85	\$15.24	\$13.87
■S-15111*	56 x 10 x 32"		10.4				20.89	18.82	17.20
<b>MATTRESS BOXES</b>							5	25	100+
■S-10659*	28 x 6 x 52"	Crib	5.1	Crib Mattress			\$8.64	\$8.36	\$8.14
■S-10664	39 x 8 x 75"	Twin Size	13.5	Twin Size Mattress	5	200#	16.69	16.29	15.79
■S-10667	54 x 8 x 75"	Full Size	18.75	Full Size Mattress			21.72	20.67	20.06
■S-10668	81 x 11 x 40 - 80"	Queen/King	41.25	Queen/King Size Mattress			39.18	38.12	36.95
<b>SKI BOX – TELESCOPIC</b>							15	100	250+
S-12590	10 x 6 x 57 - 108"	Ski Box	3.75	Skis and Ski Poles	15	200#	\$10.80	\$10.42	\$9.79
<b>SUITCASE BOX – MULTI-DEPTH</b>							10	100	250+
S-12610	24 x 13 x 31, 26"	Suitcase Box	5.6	Suitcase	10	200#	\$4.98	\$4.68	\$4.38
<b>RIFLE BOXES</b>							15	100	250+
S-17997*	8 x 4 x 46"	Shotgun	0.9	Midsize Shotgun/Rifle			\$3.52	\$3.21	\$3.09
S-12650*	8 x 4 x 52"	Rifle Box	1.0	Rifle	15	200#	3.14	3.14	3.14
S-17998*	14 x 4 x 42"	Compact Rifle	1.4	Compact Rifle			4.72	4.37	4.15
S-19782*	14 x 4 x 52"	Rifle Box	1.7	Large Rifle/Scope			5.66	5.20	4.97

■ SHIPS VIA MOTOR FREIGHT \* FOL = FULL OVERLAP



# DELUXE ARTWORK SHIPPERS



MODEL NO.	INSIDE DIM. W x L x H	FITS MAX. FRAME SIZE	TEST	PRICE PER BOX		
				1	5	10+
S-17580	17 x 22½ x 3"	14 x 19 x 2"	350#	\$55	\$51	\$48
S-13272	22 x 27 x 3"	19 x 24 x 2"	350#	66	62	58
S-17581	23 x 29 x 5"	20 x 26 x 4"	500# DW	125	118	111
S-17582	25 x 30 x 8"	22 x 27 x 6"	500# DW	143	134	125
S-15176	28 x 36 x 5"	25 x 33 x 4"	500# DW	127	122	113
S-9919	31 x 36 x 3"	28 x 33 x 2"	350#	114	108	103
S-17584	34 x 42 x 5"	31 x 39 x 4"	500# DW	167	155	147
■S-16375	34 x 49 x 4"	31 x 46 x 3"	350#	185	174	165
■S-11305	35 x 42 x 4"	32 x 39 x 3"	350#	147	138	129
■S-17587	38 x 58 x 5½"	35 x 55 x 4½"	500# DW	253	238	224
■S-17586	40 x 45 x 7¾"	37 x 42 x 6"	500# DW	249	235	221
■S-15177	43 x 43 x 4"	40 x 40 x 3"	350# DW	169	159	149
■S-9920	43 x 53 x 4"	40 x 50 x 3"	500# DW	226	211	198
■S-11306	45 x 58 x 5½"	42 x 55 x 4½"	500# DW	284	270	255
■S-16376	50 x 50 x 4"	47 x 47 x 3"	500# DW	224	209	195
■S-16377	51 x 66 x 4"	48 x 63 x 3"	500# DW	285	271	256
■S-17589	62 x 62 x 5"	59 x 59 x 4"	500# DW	381	370	352

Protection for your most valuable artwork.

- Heavy duty, plastic-lined top and bottom prevent punctures.
- Artwork floats between thick, soft foam pillows. • Foam is removable.
- Approved by all major air and ground carriers, including UPS and FedEx®.

■ SHIPS VIA MOTOR FREIGHT

## ARTWORK/MIRROR BOXES



SMALL PICTURE FRAME BOX  
S-4552



LARGE PICTURE FRAME BOX  
S-4679



MEDIUM PICTURE FRAME BOX  
S-4554



X-LARGE  
4 PC. MIRROR BOX  
S-4832



Insert pictures or mirrors up to 36" wide. Height expands from 30 to 60".

SOLD IN BUNDLE QUANTITIES

MODEL NO.	INSIDE DIM. L x W x H	BOX NAME	BNDL. QTY.	TEST	PRICE PER BOX		
					5-25	100	250+
S-4552*	24 x 5 x 18"	Small Art	25	200#	\$1.86	\$1.86	\$1.86
■S-4768*	28 x 5½ x 38"	Small Art/Mirror	20	200#	5.19	4.84	4.50
S-4553*	30 x 5 x 24"	Small Art	10	200#	2.73	2.73	2.73
■S-4554*	36 x 5 x 30"	Medium Art	20	200#	4.04	4.04	4.04
■S-4679*	36 x 6 x 42"	Large Art	10	275#	7.92	7.92	7.92
■S-4680*	36 x 5½ x 48"	X-Large Art	10	275#	13.18	12.19	10.80
S-4832	30 x 3½ x 40"	X-Large 4 pc. Mirror/Art	5	200#	10.36	9.59	8.94
S-4778	37 x 4 x 30 - 60"	X-Large 2 pc. Telescopic	10	200#	15.79	15.02	14.29
■S-11251	48 x 6 x 38 - 72"	X-Large 2 pc. Telescopic	10	275#	20.30	19.10	18.09

ADDITIONAL PICTURE FRAME BOXES, SEE PAGE 76.

FRAME PROTECTORS, SEE PAGE 312.

\* FOL = FULL OVERLAP ■ SHIPS VIA MOTOR FREIGHT

# TELESCOPIC BOXES

200 LB. TEST

Safely ship and protect your odd-sized products.

- Adjustable 2-piece design fits product snugly to prevent damage from shifting.
- Flat Telescopic recommended for large framed art or mirrors.
- Tall Telescopic recommended for rugs, golf clubs or lamps.



FLAT BOXES

## TALL

MODEL NO.	INSIDE DIMENSIONS L x W x H	PRICE PER BOX (SOLD IN BUNDLE QTYS.)					BUNDLE QTY.
		25	100	250	500	1,000+	
S-4870	4 x 4 x 48 - 90"	\$4.05	\$3.74	\$3.53	\$3.30	\$3.13	25
S-18236	4 x 4 x 72 - 132"	8.25	7.54	6.91	6.47	6.16	25
S-4872	6 x 6 x 48 - 90"	6.16	5.77	5.40	5.13	4.91	25
S-19780•	6 x 6 x 48 - 90"	12.57	11.71	10.93	10.31	9.90	15
S-4973	6 x 6 x 72 - 132"	12.02	11.01	10.07	9.42	8.94	15
S-4921	8 x 8 x 48 - 90"	8.63	8.13	7.60	7.20	6.88	20
S-20429•	8 x 8 x 48 - 90"	17.51	16.41	15.25	14.38	13.65	15
S-18952	8 x 8 x 72 - 132"	15.97	14.61	13.40	12.52	11.92	15
S-12590	10 x 6 x 57 - 108"	10.80	10.42	9.79	9.19	8.44	15
S-4919	10 x 10 x 48 - 90"	9.65	9.30	8.66	8.26	7.86	20
■S-19781	10 x 10 x 72 - 132"	20.03	18.35	16.78	15.63	14.91	15
S-18237	12 x 4 x 48 - 90"	8.84	8.55	8.02	7.45	6.88	25
S-4983	12 x 12 x 48 - 90"	12.45	11.77	11.15	10.36	9.59	15
■S-18238	12 x 12 x 72 - 132"	24.00	22.00	20.00	19.00	18.00	15
S-12595	14 x 14 x 40 - 74"	10.32	9.80	9.29	8.65	8.26	15
S-11249	16 x 16 x 40 - 74"	11.26	10.57	10.02	9.30	8.64	10
■S-20428	18 x 18 x 40 - 74"	13.07	12.26	11.61	10.80	10.02	10
■S-11250	20 x 20 x 40 - 74"	14.87	13.98	13.21	12.28	11.39	10
■S-22172	22 x 22 x 40 - 74"	17.25	16.40	15.60	14.79	14.03	10
■S-14278	24 x 24 x 40 - 74"	19.08	18.14	17.25	16.33	15.52	10
■S-23297	30 x 30 x 40 - 74"	25.00	24.00	23.00	22.00	20.00	10

## FLAT

■S-14259•	24 x 8 x 57 - 108"	\$40.00	\$39.00	\$37.00	\$34.00	\$32.00	5
S-12612	30 x 6 x 24 - 44"	11.24	10.76	10.32	9.80	9.26	10
S-4778	37 x 4 x 30 - 60"	15.79	15.02	14.29	13.65	13.18	10
■S-11251*	48 x 6 x 38 - 72"	20.30	19.10	18.09	16.79	15.56	10

■ SHIPS VIA MOTOR FREIGHT \* 275 LB. TEST • 275 LB. TEST DW



TALL BOXES



# RECORD STORAGE RACKS

SHELVING COMPLETE LINE,  
PAGES 452-487.

Specifically designed for Storage File Boxes.

- Quick, easy boltless assembly. Shelves snap into place and adjust in 1/2" increments.
- 4 shelf supports and smooth, solid 5/8" particle boards included.
- 15" Deep Unit – Store one row of boxes. • 30" Deep Unit – Store two rows of boxes.

MODEL NO.	DIMENSIONS W x D x H	FILE BOX CAPACITY	SHELF CAP. (LBS.)	PRICE EACH		WT. (LBS.)
				1	2+	
H-6689	42 x 15 x 84"	24	1,500	\$230	\$220	108
■H-6692	42 x 30 x 84"	48		295	280	162
■H-5377	69 x 15 x 84"	40	1,200	305	290	158
■H-5378	69 x 30 x 84"	80		400	380	245

■ SHIPS UNASSEMBLED VIA MOTOR FREIGHT

IN STOCK IN 13 LOCATIONS  
FAST DELIVERY GUARANTEED



# ULINE STORAGE FILE BOXES

**ULINE**

**STACK 5-7 HIGH**



S-2751

S-2752

Interlocking flaps keep product secure and dust out.

- Crushproof and easy to stack.
- Large labeling area for easy identification.
- Strong, double wall construction.

MODEL NO.	RECORD TYPES	SIZE L x W x H	QTY./BNDL.	PRICE PER BOX (SOLD IN BUNDLE QTYS.)			
				10	50	100	200+
S-2751	Letter	24 x 12 x 10"	10	\$5.30	\$5.05	\$4.60	\$4.15
S-2752	Legal	24 x 15 x 10"		7.65	7.00	6.25	5.70

**BANKERS BOX®**

**STACK 5-7 HIGH**

String and button closure provides maximum security.

- Protects records – Dust and dirt-free storage.
- Easy-pull, plastic handle on letter and legal sizes.



S-6523

S-17995

MODEL NO.	RECORD TYPES	SIZE L x W x H	QTY./BNDL.	PRICE PER BOX (SOLD IN BUNDLE QTYS.)			
				12	24	48	96+
S-17995	Checks	23 x 9 x 4"	12	\$12.80	\$12.45	\$11.90	\$11.60
S-6523	Letter	24 x 12 x 10 1/4"		16.20	15.95	15.10	14.80
S-6524	Legal	24 x 15 x 10 1/4"		18.05	17.75	17.05	16.50



S-9939

S-9938

**STORAGE DRAWERS**

**STACK UP TO 5 HIGH**

Create an instant file cabinet.

- Attached handles provide easy access to files.
- 4 corrugated layers with reinforced metal frame keep boxes stacked perfectly.

MODEL NO.	RECORD TYPES	SIZE L x W x H	QTY./BNDL.	PRICE PER BOX (SOLD IN BUNDLE QTYS.)			
				6	12	18	24+
S-9938	Letter	23 1/4 x 12 1/2 x 10 3/8"	6	\$31.70	\$30.65	\$29.65	\$29.40
S-9939	Legal	23 1/4 x 15 1/2 x 10 3/8"		35.85	34.90	34.55	33.75

## FLIP-TOP FILE BOXES

**EASY ACCESS**



S-10675

S-21531

Attached lid flips up for quick file access.

- Heavy-duty construction. Triple wall ends. Double wall bottom.
- Holds letter/legal-size files.

MODEL NO.	SIZE L x W x H	COLOR	QTY./BNDL.	PRICE PER BOX (SOLD IN BUNDLE QTYS.)		
				12	24	48+
S-21531	15 x 12 x 10"	Kraft	12	\$5.10	\$4.80	\$4.50
S-10675		White		5.30	5.10	4.80

## HANG'N'STOR™

**BANKERS BOX®**



Plastic channels allow hanging file folders to slide easily.

- Double wall construction on all 4 sides and bottom.
- Lid fits securely. Neatly stack 5-7 high.
- Holds letter/legal-size files.

MODEL NO.	SIZE L x W x H	QTY./BNDL.	PRICE PER BOX (SOLD IN BUNDLE QTYS.)			
			4	12	24	48+
S-18302	15 3/4 x 12 3/8 x 10"	4	\$14.40	\$13.65	\$12.95	\$12.20

# ULINE STORAGE FILE BOXES

## ECONOMY

STACK 1-2 HIGH

Create instant filing space.

- Flaps fold in for easy file hanging.
- 200 lb. test RSC withstands rough handling.
- Letter/legal size holds 15" of letter-size files, 12" of legal-size files.



MODEL NO.	RECORD TYPES	SIZE L x W x H	QTY./BNDL.	PRICE PER BOX (SOLD IN BUNDLE QTYS.)				
				15-25	100	250	500	1,000+
S-4153	Letter/Legal	15 x 12 x 10"	25	\$1.40	\$1.40	\$1.40	\$1.40	\$1.40
S-4570	Letter	24 x 12 x 10"		2.50	2.30	2.20	2.10	1.95
S-4957	Legal	24 x 15 x 10"	15	3.00	2.80	2.70	2.50	2.30

## ECONOMY WITH LID

STACK 3-4 HIGH

Lift-off lid provides quick and easy file access.

- Super strong double wall construction on two sides and bottom.
- Convenient die-cut handle at both ends for quick, easy file relocation.
- Shipped flat for storage and shipping savings.

Additional lids, see uline.com

MODEL NO.	RECORD TYPES	SIZE L x W x H	QTY./BNDL.	PRICE PER BOX (SOLD IN BUNDLE QTYS.)			
				12	24	48	96+
S-6521	Letter/Legal	15 x 12 x 10"	25	N/A	\$2.00	\$2.00	\$2.00
S-9879	Letter	24 x 12 x 10"	12	\$4.35	4.00	3.60	3.30
S-9880	Legal	24 x 15 x 10"		5.10	4.80	4.60	4.10



## HEAVY DUTY

STACK 5-7 HIGH

Easy access to files.

- Removable lids.
- Double wall construction on two sides and bottom.

MODEL NO.	RECORD TYPES	SIZE L x W x H	QTY./BNDL.	PRICE PER BOX (SOLD IN BUNDLE QTYS.)			
				12	24	48	96+
S-3887	Letter/Legal	15 x 12 x 10"	12	\$4.75	\$4.75	\$4.75	\$4.75
S-3888	Letter	24 x 12 x 10"		8.05	7.60	6.80	6.45
S-3889	Legal	24 x 15 x 10"		9.40	8.55	8.00	7.50



## QUICK FILE

STACK 5-7 HIGH

- Folds up in seconds!
- Double wall construction on all 4 sides and bottom for superior strength.
- Auto-lock bottom makes assembly quick and easy.



MODEL NO.	RECORD TYPES	SIZE L x W x H	QTY./BNDL.	PRICE PER BOX (SOLD IN BUNDLE QTYS.)			
				12	24	48	96+
S-9881	Letter/Legal	15 x 12 x 10"	12	\$5.20	\$5.20	\$5.20	\$5.20
S-9882	Letter	24 x 12 x 10"		8.70	8.20	7.45	7.15
S-9883	Legal	24 x 15 x 10"		10.20	9.60	8.55	8.05



# CHIPBOARD BOXES



Two-piece folding boxes ideal for office stationery, business cards, etc.

- Sturdy corner lock construction. • .024 thickness.
- Made of 100% recycled material with an attractive white coating.

MODEL NO.	INSIDE DIMENSIONS W x L x H	USE	QTY./ CTN.	PRICE PER CARTON			LBS./ CTN.
				1	3	5+	
S-22125*	3½ x 2 x 2"	Business Cards	200	\$54	\$47	\$41	10
S-5799	3½ x 4¼ x 2"			89	78	71	17
S-18956	3½ x 6 x 2"			94	84	76	23
S-5800	3½ x 7 x 2"			98	87	79	24
S-5801	3½ x 10 x 2"			108	99	89	29
S-18328	3½ x 12 x 2"			117	108	99	34
S-5802	8½ x 11 x 2"	Letterhead	200	168	153	143	50
S-18957	8½ x 11 x 3"		150	188	174	165	52
S-5803	8½ x 11 x 4"		150	195	181	171	64

\* Slightly different than pictured



## RIGID SET-UP BOXES

Ship your finest quality business cards, letterhead or stationery.

- Attractive semi-gloss top. Sturdy lid and bottom.
- Fully assembled – No folding needed. • .032 thickness.

MODEL NO.	INSIDE DIMENSIONS W x L x H	USE	QTY./ CTN.	PRICE PER CARTON			LBS./ CTN.
				1	3	5+	
S-10706	3½ x 4¼ x 2"	Business Cards	50	\$54	\$51	\$49	6
S-18964	3½ x 6 x 2"			56	52	50	7
S-10707	3½ x 7 x 2"			57	54	51	8
S-14207	3½ x 10 x 2"			63	60	58	9
S-16331	3½ x 12 x 2"			71	69	66	11
S-10708	8½ x 11 x 2"			Letterhead	20	40	38
S-13274	8½ x 11 x 4"	10	32		29	27	6



S-17644

## PRODUCE BOXES

Safely package and ship fresh vegetables and fruits.

Tomato Boxes and Foam Netting, see [uline.com](http://uline.com)

- Vent holes minimize spoilage. Self-locking.
- Space provided to identify product and grower/packer.
- Wax coating inside and outside to resist humidity and moisture.

SOLD IN BUNDLE QUANTITIES

MODEL NO.	DESCRIPTION	INSIDE DIMENSIONS L x W x H	USE	BN DL./ SKID QTY.	LBS./ BN DL.	TEST	PRICE PER BOX	
							15	90+
S-17644	1/2 Bushel	14 x 10¾ x 6¾"	Peaches	15/480	19	200#	\$3.25	\$2.80
S-17645	1½ Bushel	15½ x 11½ x 13¾"	Cucumbers	15/240	29	40 ECT	5.60	4.90
S-20443	1.8 Bushel	22½ x 15½ x 11¾"	Cabbage	15/240	44	44 ECT	7.50	6.45



S-18943

Includes box and partitions

## CANNING JAR BOXES

Corrugated inserts accommodate 12 half pint, pint or quart jars.

- 200 lb. test box withstands rough handling. • Ships flat, saves storage space.

Canning Jars sold separately, see page 625

SOLD IN BUNDLE QUANTITIES

MODEL NO.	DESCRIPTION	USABLE CELL DIM.	TEST	QTY./ BN DL.	PRICE PER BOX		
					10	50	100+
S-18942	12 Half Pint Jars	3 x 3 x 4"	200#	10	\$3.25	\$3.00	\$2.80
S-18943	12 Pint Jars	3¼ x 3¼ x 5¼"			4.25	3.75	3.45
S-18944	12 Wide Mouth Pint Jars	3¾ x 3¾ x 4¾"			4.35	4.10	3.60
S-18945	12 Quart Jars	3¾ x 3¾ x 7"			5.75	5.25	4.90



# REVERSE TUCK CARTONS

## KRAFT

MODEL NO.	INSIDE DIMENSIONS L x W x H	THICKNESS	QTY./CASE	PRICE PER CASE			LBS./CASE
				1	3	5+	
S-9890	1½ x 1½ x 2"	.024	500	\$65	\$60	\$55	9
S-14206	1½ x 1½ x 3"	.024	500	67	62	58	11
S-7364	1½ x 1½ x 4"	.024	500	69	65	60	13
S-21070	1½ x 1½ x 5"	.024	500	71	67	62	15
S-18291	2 x 1¼ x 3"	.024	500	71	66	61	12
S-9887	2 x 2 x 2"	.024	500	72	67	62	14
S-7365	2 x 2 x 3"	.024	500	75	70	65	15
S-7366	2 x 2 x 4"	.024	500	82	74	67	18
S-18938	2 x 2 x 5"	.024	500	92	86	77	19
S-15132	2 x 2 x 6"	.024	500	94	88	80	24
S-7367	2 x 2 x 7"	.036	500	101	94	87	38
S-18292	2½ x 2½ x 8"	.036	500	130	122	113	49
S-21071	3 x 2 x 3"	.036	500	106	98	91	27
S-18293	3 x 2 x 4"	.036	500	108	101	93	30
S-20407	3 x 2 x 5¼"	.036	500	111	104	96	37
S-9888	3 x 3 x 3"	.036	500	113	106	97	40
S-7368	3 x 3 x 4"	.036	500	116	109	101	42
S-16329	3 x 3 x 5"	.036	250	63	60	55	25
S-7369	3 x 3 x 6"	.036	250	66	62	58	27
S-18294	3 x 3 x 10"	.036	250	76	73	69	36
S-18295	4 x 2½ x 6¼"	.036	250	68	65	60	28
S-7370	4 x 4 x 4"	.036	250	75	70	66	32
S-18296	4 x 4 x 5"	.036	250	80	74	70	35
S-7371	4 x 4 x 6"	.036	250	86	80	74	40
S-16330	4 x 4 x 8"	.036	250	96	91	86	44
S-8395	5 x 5 x 5"	.036	250	131	123	114	53
S-8396	6 x 4 x 4"	.036	250	108	103	94	44
S-15133	6 x 4 x 6"	.036	250	133	126	116	48
S-15134	8 x 3 x 8"	.036	250	137	129	121	58
S-8397	8 x 4 x 4"	.036	250	129	122	113	52



Master pack your products with these strong, lightweight inner cartons.

- Ideal for small parts and samples.
- Assemble easily without tape or staples.
- Ship and store flat.

## WHITE

MODEL NO.	INSIDE DIMENSIONS L x W x H	THICKNESS	QTY./CASE	PRICE PER CASE			LBS./CASE
				1	3	5+	
S-21072	1½ x 1½ x 4"	.024	500	\$78	\$74	\$70	15
S-18297	2 x 2 x 4"	.024	500	92	86	77	19
S-18298	3 x 3 x 4"	.024	500	128	120	111	33
S-18299	3 x 3 x 6"	.024	250	73	69	65	21
S-18300	4 x 4 x 4"	.024	250	84	77	73	25
S-18301	4 x 4 x 6"	.024	250	94	89	83	31



# PLASTIC STORAGE FILE BOXES

Provide long-term storage for your stuff. Strong and sturdy plastic.

- Withstands up to 600 lbs. of pressure. Stack up to 8' high.
- Resists heat, repels water.
- Double wall on handle sides and bottom.

SOLD IN CARTON QUANTITIES

MODEL NO.	INSIDE DIMENSIONS L x W x H	QTY./CTN.	PRICE PER BOX			
			5	10	25	50+
S-14455	15 x 12 x 10"	5	\$22.50	\$22.00	\$21.50	\$21.00
S-16322	24 x 12 x 10"	5	28.50	28.00	27.50	27.00



# WHITE EASY-FOLD MAILERS

ADJUSTABLE DEPTH



S-342  
12 1/8 x 9 1/8"



S-343  
12 1/2 x 12 1/2"

Cleaner, neater appearance for your product shipments.

- Ship books, catalogs, photos and other printed material.
- Prevent product damage.
- Minimum order 100.



S-341  
11 1/8 x 8 5/8"



S-11259  
9 1/2 x 6 1/2"

MODEL NO.	INSIDE DIMENSIONS		SUGGESTED USE	PRICE EACH (SOLD IN BUNDLE QTYS.)				QTY./ BNDL.	LBS./ BNDL.
	L x W	VARIABLE DEPTH		100	300	500	1,000+		
S-5582	7 1/2 x 5 1/2"	1/2, 1, 1 1/2, 2"	Photo Prints	\$.90	\$.75	\$.69	\$.62	100	15
S-5583	9 1/2 x 6 1/2"	1/2, 1, 1 1/2, 2"	Digest Size	.99	.93	.86	.77	100	19
S-11259	9 1/2 x 6 1/2"	2, 2 1/2, 3, 3 1/2"	Digest Size	1.29	1.19	1.11	1.04	100	23
S-329	9 5/8 x 6 5/8"	5/8, 1"	Digest Size	.90	.75	.69	.62	100	17
S-319	10 1/4 x 8 1/4"	5/8, 1 1/4"	Books	.99	.92	.86	.75	100	21
S-326	10 1/4 x 10 1/4"	1/2, 1"	Decorative Plates	1.18	1.11	1.02	.93	100	25
S-339	11 1/8 x 8 5/8"	1/2, 1"	100-200 Sheets	1.02	.94	.90	.80	100	23
S-341	11 1/8 x 8 5/8"	1/2, 1, 1 1/2, 2"	100-400 Sheets	1.12	1.04	1.01	.92	100	25
S-3178	11 1/8 x 8 3/4"	1/2, 3, 3 1/2, 4"	100-800 Sheets	1.61	1.52	1.44	1.38	100	34
S-327	12 1/8 x 9 1/8"	1/2, 1"	Bus. Rpts., Magazines	1.12	1.04	.98	.90	100	26
<b>S-342</b>	<b>12 1/8 x 9 1/8"</b>	<b>1/2, 1, 1 1/2, 2"</b>	<b>Booklets</b>	<b>.96</b>	<b>.96</b>	<b>.96</b>	<b>.96</b>	<b>100</b>	<b>30</b>
S-11260	12 1/8 x 9 1/8"	2 1/2, 3, 3 1/2, 4"	Booklets	1.74	1.64	1.60	1.49	100	37
S-343	12 1/2 x 12 1/2"	1/2, 1"	LP Records	1.34	1.25	1.17	1.04	100	36
S-5822	12 1/2 x 12 1/2"	1/2, 1, 1 1/2, 2"	LP Records	1.65	1.60	1.50	1.42	100	40
S-11261	14 x 14"	1, 2, 3, 4"	Large Photos, Prints	2.51	2.38	2.30	2.18	50	25
S-328	14 1/8 x 8 5/8"	1/2, 1"	Legal Size	1.17	1.05	1.02	.92	100	28
S-15020	14 1/4 x 11 1/4"	1/2, 1, 1 1/2, 2"	Double Ream	1.70	1.61	1.52	1.42	50	20
S-345	15 x 11 1/8"	1/2, 1, 1 1/2, 2"	Prints	1.73	1.63	1.57	1.46	50	21
S-348	17 1/8 x 14 1/8"	1/2, 1, 1 1/2, 2"	Frames, Prints	1.90	1.75	1.70	1.63	50	29
S-20423	20 x 16"	1/2, 1, 1 1/2, 2"	Artwork	2.68	2.54	2.39	2.34	50	35
S-13354	24 x 18"	1/2, 1, 1 1/2, 2"	Artwork	3.19	2.94	2.88	2.67	50	45
S-20424	24 x 24"	1/2, 1, 1 1/2, 2"	Large Prints	4.27	4.05	3.83	3.72	25	31
S-21598	28 x 22"	1/2, 1, 1 1/2, 2"	Poster Board	4.40	4.17	3.97	3.87	25	32

# DELUXE EASY-FOLD MAILERS

When first impressions are important. The best Easy-Fold on the market.

- Patented easy tear strip will please your customers.
- Adhesive strip seals carton shut.



S-6495  
12 1/8 x 9 1/8"

ADHESIVE STRIP



TEAR STRIP

MODEL NO.	INSIDE DIMENSIONS		SUGGESTED USE	PRICE EACH (SOLD IN BUNDLE QTYS.)				QTY./ BNDL.	LBS./ BNDL.
	L x W	VARIABLE DEPTH		50	100	300	500+		
S-7658	11 1/8 x 8 5/8"	1/2, 1, 1 1/2, 2"	100-400 Sheets	\$2.64	\$2.30	\$2.16	\$1.96	50	14
S-6495	12 1/8 x 9 1/8"	3/8, 3/4, 1 1/8, 1 1/2, 1 3/4"	Books	2.75	2.40	2.21	2.05	50	16

# KRAFT EASY-FOLD MAILERS



MODEL NO.	INSIDE DIMENSIONS		SUGGESTED USE	PRICE EACH (SOLD IN BUNDLE QTYS.)				QTY./BNDL.	LBS./BNDL.
	L x W	VARIABLE DEPTH		100	300	500	1,000+		
S-5821	7½ x 5½"	½, 1, 1½, 2"	Photo Prints	\$.75	\$.69	\$.66	\$.61	100	15
S-18172	7½ x 7½"	½, 1"	45 RPM Records	.72	.66	.65	.60	100	17
S-11215	9½ x 6½"	½, 1, 1½, 2"	Digest Size	.94	.90	.80	.72	100	19
S-1612	9⅝ x 6⅝"	⅝, 1, 1¼"	Digest Size	.85	.75	.72	.66	100	16
S-2674	10¼ x 8¼"	⅝, 1"	Books	.96	.87	.84	.71	100	21
S-1613	11 x 8½"	2, 2½, 3"	400-600 Sheets	1.42	1.36	1.28	1.19	100	48
S-164	11½ x 8⅝"	½, 1"	100-200 Sheets	1.01	.93	.87	.77	100	23
<b>S-165</b>	<b>11½ x 8⅝"</b>	<b>½, 1, 1½, 2"</b>	<b>100-400 Sheets</b>	<b>.86</b>	<b>.86</b>	<b>.86</b>	<b>.86</b>	<b>100</b>	<b>27</b>
S-1614	11½ x 8¾"	½, 3, 3½, 4"	100-800 Sheets	1.58	1.49	1.42	1.36	100	34
S-3389	11¾ x 10½"	1¾, 2¼"	Magazines	1.49	1.39	1.34	1.25	100	49
S-1615	12 x 9"	2, 2½, 3"	Folders	1.71	1.61	1.50	1.36	100	35
S-3655	12 x 10½"	½, 1, 1½, 2"	1" Binder	1.94	1.75	1.63	1.58	50	19
S-7920	12 x 11½"	1½, 2, 2½, 3"	2" Binder	1.97	1.88	1.70	1.62	50	20
S-166	12½ x 9⅝"	½, 1, 1½, 2"	Booklets	1.32	1.23	1.15	1.12	100	32
S-167	12½ x 12½"	½, 1"	LP Records	1.29	1.19	1.11	1.04	100	35
S-3177	12½ x 12½"	1, 1½, 2½"	LP Records	1.60	1.50	1.42	1.34	50	30
S-11216	14¼ x 11¼"	½, 1, 1½, 2"	Double Ream	1.65	1.58	1.49	1.40	50	20
S-2675	15 x 11⅝"	½, 1, 1½"	Prints	1.61	1.52	1.44	1.36	100	42
S-5596	15 x 11⅝"	2, 3, 4, 5, 6"	Prints	2.16	2.08	2.02	1.94	25	13
S-168	17½ x 14⅝"	½, 1, 1½, 2"	Frames, Prints	1.84	1.73	1.64	1.61	100	56
S-11217	17½ x 11¼"	½, 1, 1½, 2"	Expandable Files	1.75	1.65	1.60	1.52	50	25
S-14240	18 x 12"	½, 1, 1½, 2"	Books	1.92	1.84	1.65	1.61	50	28
S-20994	18 x 18"	½, 1, 1½, 2"	Large Prints	2.69	2.55	2.39	2.33	50	38
S-13356	20 x 16"	½, 1, 1½, 2"	Artwork	2.54	2.40	2.30	2.22	50	35
S-22115	24 x 18"	½, 1, 1½, 2"	Artwork	3.10	2.83	2.77	2.57	50	45

Protect and ship multiple catalogs, books and other printed materials.

- Adjustable – Scored at ½", ⅝" or 1" intervals.
- 200 lb. test, B-flute.
- Minimum order 100.



# JUMBO WHITE FOLD-OVER MAILERS

MODEL NO.	INSIDE DIMENSIONS		PRICE EACH (SOLD IN BUNDLE QTYS.)				QTY./BNDL.	LBS./BNDL.
	L x W	DEPTH	20	40	100	200+		
S-3332	20 x 16"	1"	\$4.69	\$4.37	\$4.16	\$3.94		14
S-15021	28 x 22"	¼"	5.01	4.63	4.37	4.01		25
S-3333	30½ x 22¼"	¼"	5.23	4.90	4.59	4.26		29
S-15022	30½ x 22¼"	1"	5.60	5.19	4.86	4.56	20	28
■S-3334	36 x 24"	¼"	5.65	5.23	4.90	4.59		35
■S-13355	36 x 24"	1"	6.57	6.10	5.75	5.43		36
■S-20995	38 x 26"	1"	7.44	6.93	6.51	6.07		43



Insert product, fold sides over and tape flap for easy shipping.

■ SHIPS VIA MOTOR FREIGHT



# JUMBO MAILERS



Quickly package large, flat items like artwork, photos, maps and blueprints.

- Recommended for framed pictures or mirrors.
- 200 lb. test.

## KRAFT EASY-FOLD MAILERS

MODEL NO.	INSIDE DIMENSIONS		PRICE EACH (SOLD IN BUNDLE QTYS.)				QTY./ BNDL.	LBS./ BNDL.
	L x W	VARIABLE DEPTH	20	40	100	200+		
S-12660	20 x 16"	1, 2, 4, 6"	\$4.40	\$4.27	\$4.05	\$3.83	20	18
■S-14241	20 x 20"		4.87	4.55	4.47	4.15		22
■S-14242	22 x 18"		4.71	4.39	4.32	4.01		22
■S-11218	24 x 18"		5.03	4.63	4.55	4.22		24
■S-3396	24 x 20"		5.28	4.90	4.83	4.48		26
■S-6517	24 x 24"	1, 2, 4, 6"	5.44	5.07	4.91	4.60	20	30
■S-15023	26 x 20"		5.36	4.98	4.87	4.56		29
■S-9857	28 x 22"		5.52	5.19	5.01	4.69		32
■S-13357	28 x 24"		5.72	5.35	5.16	4.84		34
■S-13358	30 x 22"		5.62	5.26	5.07	4.76		34
■S-3656	30 x 24"	1, 2, 4, 6"	5.77	5.49	5.23	4.90	20	38
■S-18315	30 x 30"		6.98	6.62	6.31	5.93		46
■S-12661	32 x 22"		5.71	5.33	5.18	4.84		37
■S-18316	36 x 12"		4.32	4.01	3.86	3.67		27
■S-3397	36 x 24"		6.89	6.46	6.12	5.77		43
■S-11219	36 x 30"	1, 2, 4, 6"	8.58	8.06	7.62	7.22	20	46
■S-6720	36 x 36"		10.36	9.70	9.26	8.71		60
■S-5597	38 x 26"		7.85	7.42	6.96	6.65		53
■S-11220	40 x 30"		9.43	8.88	8.39	7.95		58
■S-21605	42 x 32"		10.53	9.90	9.32	8.88		65
■S-18317	48 x 24"		9.15	8.63	8.13	7.72		58
■S-18318	48 x 36"		1, 2, 3"	10.77	10.15	9.57		9.09

■ SHIPS VIA MOTOR FREIGHT

# LARGE SIDE LOADERS

Full-overlap flaps provide extra stacking strength and edge protection.

- Recommended for artwork, mirrors and other flat or narrow products.



200 LB. TEST FOL

MODEL NO.	INSIDE DIMENSIONS L x W x H	PRICE PER BOX (SOLD IN BUNDLE QTYS.)					BUNDLE/BALE QTY.
		25	100	250	500	1,000+	
S-4552	24 x 5 x 18"	\$1.86	\$1.86	\$1.86	\$1.86	\$1.86	25 / 250
S-4998	24 x 5 x 24"	3.30	3.02	2.79	2.61	2.49	10 / 140
S-18319*	24 x 6 x 18"	5.61	5.07	4.58	4.20	3.93	10 / 140
S-12653	26 x 6 x 20"	3.67	3.42	3.14	2.98	2.76	10 / 140
S-4805	28 x 4 x 24"	3.71	3.49	3.21	3.00	2.79	10 / 120
■S-4768	28 x 5½ x 38"	5.19	4.84	4.50	4.16	3.98	20 / 120
S-4553	30 x 5 x 24"	2.73	2.73	2.73	2.73	2.73	10 / 120
S-18320*	30 x 6 x 24"	8.02	7.23	6.54	5.98	5.61	10 / 140
S-10660*	30 x 6 x 30"	9.31	8.44	7.60	6.97	6.54	10 / 120
■S-18321*	30 x 6 x 40"	11.51	10.42	9.40	8.63	8.05	10 / 140
S-4947	36 x 5 x 24"	4.27	4.09	3.82	3.53	3.32	10 / 140
■S-4554	36 x 5 x 30"	4.04	4.04	4.04	4.04	4.04	20 / 120
■S-4680*	36 x 5½ x 48"	13.18	12.19	10.80	9.79	8.87	10 / 140
■S-10663*	36 x 6 x 36"	12.85	11.62	10.58	9.65	8.82	10 / 120
■S-4679*	36 x 6 x 42"	7.92	7.92	7.92	7.92	7.92	10 / 140
■S-11212*	36 x 8 x 30"	11.17	10.20	9.21	8.26	7.63	10 / 140
■S-11213*	40 x 8 x 50"	22.23	20.09	18.31	17.32	15.79	5 / 90
■S-11214*	44 x 6 x 35"	13.26	11.94	10.58	9.49	8.66	10 / 140
■S-12773*	48 x 8 x 24"	13.75	12.42	11.30	10.25	9.32	10 / 140
■S-4878*	54 x 8 x 28"	16.85	15.24	13.87	12.57	11.45	5 / 125



SLIDE YOUR PRODUCT IN EASILY

- \* 275 LB. TEST
- 275 LB. TEST DOUBLE WALL (DW)
- SHIPS VIA MOTOR FREIGHT

# KRAFT LITERATURE MAILERS

MODEL NO.	INSIDE DIMENSIONS L x W x H	SUGGESTED USE	PRICE EACH (SOLD IN BUNDLE QTY'S.)				QTY./BNDL.
			25-50	100	500	1,000+	
S-16646	6 x 6 x 2"	Small Frames	\$.69	\$.66	\$.55	\$.52	50
S-18265	7 x 3½ x 2⅝"	Business Cards	.56	.54	.42	.39	50
S-21619	7 x 7 x 2"	Invitation Envelopes	.72	.66	.56	.54	50
S-16647	8 x 8 x 3"	Small Frames	1.08	1.05	.93	.90	50
S-11221	9 x 6½ x 1¾"	Digest Size Books	.77	.72	.61	.60	50
S-3179	9 x 6½ x 2¾"	Digest Size Books	.85	.75	.64	.62	50
S-8212	9 x 6½ x 4"	Digest Size Books	1.50	1.39	1.17	1.14	50
S-16648	9 x 7½ x 3"	Booklets, Pamphlets	1.01	.96	.82	.79	50
S-14218	9 x 9 x 2"	Small Picture Frames	.87	.80	.66	.65	50
S-16649	9 x 9 x 3"	Small Picture Frames	1.15	1.06	.96	.93	50
S-16650	10 x 6 x 4"	Gifts	1.46	1.36	1.12	1.08	50
S-16651	10 x 10 x 2"	Catalogs, Books	1.12	1.05	.94	.92	50
S-18266	10 x 10 x 4"	Catalogs, Books	1.73	1.64	1.39	1.34	50
S-7867	11 x 6½ x 2¾"	Small Photo Albums	.92	.85	.69	.66	50
S-3180	11½ x 8¾ x 2"	Letterhead	1.05	.99	.77	.72	50
S-3181	11½ x 8¾ x 2⅝"	Letter Size or Smaller	1.06	1.04	.92	.87	50
S-11222	11½ x 8¾ x 3"	Stationery	1.23	1.17	1.02	.99	50
S-3182	11½ x 8¾ x 4"	Letter Size or Smaller	1.52	1.39	1.17	1.14	50
S-8298	11½ x 8¾ x 6"	Stationery	2.10	2.02	1.75	1.71	50
S-2513	11¾ x 10¾ x 2¼"	1" & 1½" Ring Binders	1.44	1.39	1.12	1.08	50
S-16652	12 x 8 x 3"	Prints	1.22	1.15	1.01	.98	50
S-13483	12 x 10 x 4"	File Folders	1.81	1.70	1.42	1.39	50
S-3387	12 x 11¾ x 3¼"	2" Ring Binders	1.64	1.60	1.39	1.34	50
S-16653	12 x 12 x 2"	Picture Frames	1.50	1.40	1.18	1.15	50
S-13484	12 x 12 x 3"	Photo Albums	1.62	1.53	1.29	1.24	50
S-8486	12 x 12 x 6"	Picture Frames	2.71	2.59	2.30	2.21	50
S-2515	12½ x 9¼ x 2"	Booklets	1.02	.93	.80	.77	50
S-6713	12½ x 9¼ x 3"	Oversized Catalogs	1.62	1.53	1.23	1.19	50
S-2516	12½ x 9¼ x 4"	Oversized Catalogs	1.64	1.58	1.29	1.24	50
S-7868	12½ x 9¼ x 6½"	Magazines	2.17	2.05	1.84	1.79	50
S-9839	13 x 10 x 2"	Oversized Calendars	1.71	1.61	1.19	1.17	50
S-14219	13 x 10 x 4"	Envelopes	1.96	1.81	1.57	1.52	50
S-16654	13 x 13 x 2"	Product Samples	1.79	1.65	1.34	1.29	50
S-11223	13 x 13 x 3"	Product Samples	1.94	1.74	1.42	1.38	50
S-18267	14 x 10 x 2"	File Folders, Calendars	1.74	1.64	1.29	1.24	50
S-16655	14 x 14 x 2"	Large Photos, Prints	1.85	1.73	1.39	1.34	50
S-9840	14¼ x 11¼ x 4"	Double Ream	1.84	1.71	1.36	1.31	50
S-11224	15½ x 11½ x 2"	Clothing	1.63	1.50	1.19	1.17	50
S-15059	15½ x 11½ x 3"	Clothing	1.91	1.73	1.44	1.40	50
S-2517	15½ x 11½ x 4"	Clothing	2.01	1.91	1.61	1.57	50
S-16656	16 x 12 x 4"	Books	2.40	2.29	1.96	1.91	50
S-18268	16 x 16 x 2"	Canvases	2.18	2.05	1.75	1.71	50
S-18269	17 x 11 x 2½"	Photos, Prints	1.92	1.73	1.50	1.46	25
S-15060	17¼ x 11¼ x 4"	Expandable Files	2.36	2.21	1.92	1.85	25
S-11225	18 x 12 x 3"	Books	2.10	2.01	1.65	1.62	25
S-2425*	24½ x 14½ x 4½"	Pants, Blazers	3.57	3.46	2.96	2.89	25
■S-2426*	28¾ x 16 x 5"	Outerwear	4.07	3.89	3.46	3.35	25

\* Slightly different than pictured

■ SHIPS VIA MOTOR FREIGHT



S-3180

S-2517

Use our best-selling sizes of literature mailers in **economical kraft**.

- 200 lb. test – Kraft corrugated.
- Ships flat – Saves storage space.



S-2516

Larger quantities, call for quote.



S-3182

# WHITE LITERATURE MAILERS



- A simple and secure way to send out business forms, binders, catalogs, stationery and magazines.
- 200 lb. test.
- Ships flat – Sets up in seconds without tape or staples.

Volume discounts available.  
Call for a quote.



MUG BOXES  
S-1719, S-6130, S-14304



MODEL NO.	INSIDE DIMENSIONS L x W x H	SUGGESTED USE	PRICE EACH (SOLD IN BUNDLE QTYS.)				QTY./ BNDL.
			20-50	100	500	1,000+	
S-1719	4 x 4 x 4"	Mug Box	N/A	\$.86	\$.66	\$.60	100
S-2457*	4 <sup>5</sup> / <sub>16</sub> x 2 <sup>3</sup> / <sub>4</sub> x 11/16"	Small Electronics	\$.45	.43	.34	.31	50
S-15136	4 <sup>3</sup> / <sub>4</sub> x 3 <sup>5</sup> / <sub>8</sub> x 2 <sup>1</sup> / <sub>8</sub> "	Business Cards	.56	.54	.42	.39	50
S-16641	5 x 3 x 2"	Small Electronics	.55	.52	.41	.37	50
S-2456*	5 <sup>5</sup> / <sub>8</sub> x 5 x 7/16"	CD Mailer	.65	.62	.54	.50	50
S-16642	6 x 6 x 1 <sup>1</sup> / <sub>4</sub> "	Small Frames	.64	.61	.46	.44	50
S-21606	6 x 6 x 3"	Small Frames	.86	.83	.69	.66	50
S-9847	7 x 3 <sup>5</sup> / <sub>8</sub> x 2 <sup>1</sup> / <sub>8</sub> "	Business Cards	.61	.58	.44	.42	50
S-15137	7 x 7 x 2"	Invitation Envelopes	.80	.71	.61	.58	50
S-9848	7 <sup>1</sup> / <sub>8</sub> x 4 <sup>1</sup> / <sub>2</sub> x 3"	Paperback Books	.90	.85	.66	.65	50
S-156	7 <sup>5</sup> / <sub>8</sub> x 7 <sup>5</sup> / <sub>8</sub> x 1 <sup>3</sup> / <sub>8</sub> "	Candy Box	.66	.62	.55	.52	50
S-157	7 <sup>1</sup> / <sub>2</sub> x 7 x 3 <sup>1</sup> / <sub>4</sub> "	1,000 IBM Cards	1.11	1.04	.90	.86	50
S-6130	7 <sup>5</sup> / <sub>8</sub> x 4 <sup>1</sup> / <sub>4</sub> x 3 <sup>3</sup> / <sub>4</sub> "	2 Mug Box	1.74	1.65	1.18	1.15	20
S-15138	8 x 7 x 2"	Cards	.84	.77	.62	.60	50
S-15139	8 x 7 x 3"	Cards	1.04	.99	.84	.82	50
S-15140	8 x 7 x 4"	Cards	1.19	1.12	.94	.93	50
S-16664	8 x 8 x 1 <sup>1</sup> / <sub>4</sub> "	Small Frames	.85	.82	.64	.61	50
S-14303	8 x 8 x 2"	Small Frames	.90	.86	.66	.65	50
S-12639	8 x 8 x 4"	Small Frames	1.36	1.25	1.06	1.04	50
S-374	8 <sup>1</sup> / <sub>4</sub> x 4 <sup>3</sup> / <sub>4</sub> x 1 <sup>3</sup> / <sub>16</sub> "	Video Mailer	.99	.92	.75	.71	50
S-14304*	8 <sup>13</sup> / <sub>16</sub> x 8 <sup>13</sup> / <sub>16</sub> x 4 <sup>1</sup> / <sub>4</sub> "	4 Mug Box	3.34	3.14	2.25	2.21	20
S-16665	9 x 4 x 3"	Gifts	1.02	.94	.69	.66	50
S-9849	9 x 6 <sup>1</sup> / <sub>2</sub> x 1 <sup>3</sup> / <sub>4</sub> "	Digest Size Books	.99	.92	.66	.64	50
S-159	9 x 6 <sup>1</sup> / <sub>2</sub> x 2 <sup>3</sup> / <sub>4</sub> "	Digest Size Albums	.63	.63	.63	.63	50
S-5262	9 x 6 <sup>1</sup> / <sub>2</sub> x 4"	Digest Size Books	1.63	1.53	1.29	1.24	50
S-15141	9 x 6 <sup>1</sup> / <sub>2</sub> x 6"	Books	2.50	2.30	1.95	1.90	50
S-11241	9 x 7 <sup>1</sup> / <sub>2</sub> x 3"	Plaques	1.11	1.04	.86	.84	50
S-15142	9 x 8 x 2"	Plaques	.90	.86	.66	.65	50
S-11242	9 x 9 x 2"	Small Picture Frames	.98	.93	.72	.69	50
S-8480	9 x 9 x 3"	Small Picture Frames	1.28	1.19	1.01	.98	50
S-16666	9 x 9 x 4"	Small Picture Frames	1.70	1.60	1.32	1.28	50
S-16940	10 x 4 x 3"	Gifts	1.15	1.08	.82	.79	50
S-15143	10 x 8 x 3"	Plaques	1.36	1.28	1.04	1.02	50
S-15144	10 x 9 x 2"	Collectibles	1.18	1.12	.92	.87	50
S-15145	10 x 9 x 3"	Collectibles	1.61	1.53	1.22	1.18	50
S-5581	10 x 10 x 2"	Catalogs, Books	1.36	1.28	1.04	1.01	50
S-14305	10 x 10 x 3"	Catalogs, Books	1.75	1.65	1.36	1.31	50
S-15146	10 x 10 x 4"	Catalogs, Books	1.95	1.81	1.49	1.44	50
S-9850	10 <sup>1</sup> / <sub>4</sub> x 8 <sup>3</sup> / <sub>4</sub> x 2"	Hardcover Books	1.12	1.04	.80	.77	50
S-16667	10 <sup>1</sup> / <sub>4</sub> x 8 <sup>3</sup> / <sub>4</sub> x 4"	Hardcover Books	1.95	1.81	1.50	1.46	50
S-160	11 x 6 <sup>1</sup> / <sub>2</sub> x 2 <sup>3</sup> / <sub>4</sub> "	Small Photo Albums	1.02	.94	.75	.72	50
S-16941	11 x 10 x 4"	Catalogs, Books	1.97	1.85	1.53	1.49	50
S-16668	11 x 11 x 2"	Canvases	1.61	1.52	1.23	1.19	50
S-15147	11 x 11 x 3"	Canvases	1.94	1.81	1.50	1.46	50
S-9851	11 <sup>1</sup> / <sub>8</sub> x 8 <sup>3</sup> / <sub>4</sub> x 1 <sup>1</sup> / <sub>4</sub> "	Letterhead	1.06	.99	.72	.69	50
S-273	11 <sup>1</sup> / <sub>8</sub> x 8 <sup>3</sup> / <sub>4</sub> x 2"	Letterhead	.80	.80	.80	.80	50
S-161	11 <sup>1</sup> / <sub>8</sub> x 8 <sup>3</sup> / <sub>4</sub> x 2 <sup>5</sup> / <sub>16</sub> "	Framed Pictures	1.28	1.18	1.02	.99	50
S-5204	11 <sup>1</sup> / <sub>8</sub> x 8 <sup>3</sup> / <sub>4</sub> x 3"	Stationery	1.52	1.38	1.12	1.08	50
S-274	11 <sup>1</sup> / <sub>8</sub> x 8 <sup>3</sup> / <sub>4</sub> x 4"	Letter Size or Smaller	1.61	1.49	1.22	1.18	50
S-13275	11 <sup>1</sup> / <sub>8</sub> x 8 <sup>3</sup> / <sub>4</sub> x 5"	Letterhead	1.97	1.84	1.60	1.57	50
S-11243	11 <sup>1</sup> / <sub>8</sub> x 8 <sup>3</sup> / <sub>4</sub> x 6"	Letterhead	2.30	2.18	1.95	1.90	50
S-246	11 <sup>1</sup> / <sub>2</sub> x 11 <sup>1</sup> / <sub>2</sub> x 3 <sup>3</sup> / <sub>4</sub> "	2 <sup>1</sup> / <sub>2</sub> " Tall Ring Binders	2.01	1.88	1.53	1.49	50

\* Slightly different than pictured



# WHITE LITERATURE MAILERS

MODEL NO.	INSIDE DIMENSIONS L x W x H	SUGGESTED USE	PRICE EACH (SOLD IN BUNDLE QTYS.)				QTY./BNDL.
			25-50	100	500	1,000+	
S-650	11¼ x 10¾ x 2¼"	1 & 1½" Tall Ring Binders	\$.71	\$.71	\$.71	\$.71	50
S-5263	11¼ x 10¾ x 4"	2" Tall Ring Binders	2.30	2.18	1.74	1.70	50
S-16657	12 x 10 x 4"	File Folders	2.07	1.95	1.60	1.54	50
S-2225	12 x 11¼ x 3¼"	2" Tall Ring Binders	1.84	1.71	1.49	1.44	50
S-16658	12 x 12 x 1¼"	Picture Frames	1.52	1.42	1.17	1.14	50
S-5817	12 x 12 x 2"	Picture Frames	1.88	1.73	1.42	1.39	50
S-13276	12 x 12 x 3"	Photo Album	2.07	1.95	1.61	1.57	50
S-11244	12 x 12 x 4"	Framed Pictures	2.39	2.25	1.91	1.84	50
S-15191	12 x 12 x 6"	Photo Album	3.57	3.35	2.80	2.72	50
S-12641	12½ x 9¼ x 1¼"	Booklets, Calendars	1.12	1.02	.77	.72	50
S-275	12½ x 9¼ x 2"	Booklets, Calendars	1.19	1.11	.92	.87	50
S-2423	12½ x 9¼ x 3"	Oversized Manuals	1.70	1.61	1.25	1.23	50
S-276	12½ x 9¼ x 4"	Oversized Catalogs	1.29	1.29	1.29	1.29	50
S-11245	12½ x 9¼ x 5"	Oversized Catalogs	2.16	2.02	1.75	1.71	50
S-5264	12½ x 9¼ x 6½"	Magazines	2.68	2.57	2.33	2.25	50
S-5818	12½ x 5 x 3"	Laser Labels	1.28	1.18	1.02	.99	50
S-16942	13 x 10 x 1¼"	Envelopes	1.50	1.39	1.04	1.02	50
S-5819	13 x 10 x 2"	Oversized Calendars	1.94	1.75	1.36	1.31	50
S-16659	13 x 10 x 3"	Envelopes	2.01	1.88	1.44	1.40	50
S-12640	13 x 10 x 4"	Envelopes	2.16	2.01	1.64	1.61	50
S-15192	13 x 13 x 2"	Product Samples	1.96	1.84	1.46	1.42	50
S-9852	13 x 13 x 3"	Product Samples	2.18	2.04	1.73	1.69	50
S-13407	13 x 13 x 4"	Product Samples	2.50	2.33	2.04	1.97	50
S-2424*	14 x 3¾ x 2¾"	Business Cards	1.36	1.23	1.05	1.04	50
S-13408	14 x 10 x 2"	File Folders, Calendars	1.96	1.81	1.39	1.34	50
S-16943	14 x 12 x 4"	Product Samples	2.40	2.26	1.97	1.92	50
S-8342	14 x 14 x 2"	Large Photos, Prints	2.05	1.94	1.49	1.44	50
S-16660	14 x 14 x 3"	Large Photos, Prints	2.33	2.18	1.84	1.79	50
S-14331	14 x 14 x 4"	Large Photos, Prints	2.82	2.61	2.10	2.04	50
S-16944	14 x 14 x 5"	Large Photos, Prints	3.33	3.11	2.50	2.40	50
S-11239	14½ x 8¾ x 2"	Legal Size Documents	1.94	1.75	1.36	1.31	50
S-15193	14¼ x 11¼ x 2"	Single Ream	1.96	1.81	1.39	1.34	50
S-5820	14¼ x 11¼ x 4"	Double Ream	2.01	1.91	1.58	1.54	50
S-15211	15 x 12 x 2"	Wall Calendars	2.01	1.88	1.42	1.39	50
S-277	15½ x 11½ x 2"	Clothing	1.97	1.84	1.42	1.38	50
S-11240	15½ x 11½ x 3"	Clothing	2.05	1.94	1.60	1.54	50
S-278	15½ x 11½ x 4"	Clothing	2.18	2.02	1.65	1.62	50
S-15212	16 x 8 x 3"	Product Samples	1.65	1.57	1.32	1.28	50
S-14332	16 x 8 x 4"	Product Samples	2.10	1.95	1.63	1.60	50
S-16945	16 x 10 x 3"	Albums	2.07	1.94	1.61	1.57	50
S-16661	16 x 12 x 3"	Large Frames	2.38	2.21	1.94	1.88	50
S-15213	16 x 16 x 2"	Canvases	2.36	2.18	1.92	1.85	50
S-16662	16 x 16 x 4"	Canvases	3.52	3.25	2.82	2.73	25
S-3187	17 x 11 x 2½"	Photos, Prints	2.05	1.91	1.61	1.57	25
S-8343	17¼ x 11¼ x 4"	Expandable Files	2.53	2.36	2.05	1.98	25
■S-16663	17¼ x 11¼ x 6"	Expandable Files	3.86	3.63	3.19	3.11	25
S-14333	18 x 18 x 2"	Large Frames, Tiles	2.61	2.50	2.18	2.13	25
S-3188	19 x 12 x 2½"	Promotional Materials	2.32	2.18	1.95	1.90	25
S-3189	23 x 13 x 2½"	Oversized Calendars	2.75	2.64	2.33	2.25	25
S-2487*	24½ x 14¼ x 4½"	Pants, Blazers	3.95	3.69	3.10	2.99	25
■S-2488	28¾ x 16 x 5"	Outerwear	4.79	4.49	3.83	3.71	25
■S-8344	30 x 24 x 4"	Suits, Coats	5.88	5.56	4.84	4.68	25



S-8343



S-9852



S-277



S-2488

Larger quantities,  
call for quote.

\* Slightly different than pictured

■ SHIPS VIA MOTOR FREIGHT

# KRAFT TAB LOCKING LITERATURE MAILERS



S-16964

Economical alternative.

- Front lock tabs for added security.
- 200 lb. test.



S-16932



S-16963

MODEL NO.	INSIDE DIMENSIONS L x W x H	SUGGESTED USE	PRICE EACH (SOLD IN BUNDLE QTYS.)				QTY./ BNDL.
			25-50	100	500	1,000+	
S-16950	8 x 8 x 2 3/4"	Small Frames	\$1.38	\$1.28	\$1.04	\$1.02	50
S-16953	9 x 6 1/2 x 2 3/4"	Digest Size Books	1.28	1.19	.94	.92	50
S-16954	9 x 6 1/2 x 4"	Digest Size Books	1.95	1.85	1.54	1.50	50
S-16955	10 x 8 x 1 1/2"	Photos, Prints	1.04	1.01	.85	.83	50
S-16956	10 x 10 x 4"	Catalogs, Books	2.26	2.11	1.81	1.74	50
S-16918	10 x 10 x 5"	Catalogs, Books	2.92	2.71	2.18	2.14	50
S-16951	11 1/2 x 8 3/4 x 2"	Letter Size	1.65	1.53	1.12	1.08	50
S-16921	11 1/2 x 8 3/4 x 3"	Stationery	1.96	1.79	1.42	1.38	50
S-16922	11 1/2 x 8 3/4 x 4"	Letter Size	2.25	2.08	1.64	1.61	50
S-16923	11 1/2 x 10 3/4 x 2 1/4"	1" & 1 1/2" Tall Binders	2.08	1.95	1.57	1.52	50
S-16926	12 x 10 x 6"	File Folders	3.63	3.34	2.75	2.68	50
S-16929	12 x 11 x 3"	2" Ring Binders	2.30	2.16	1.70	1.64	50
S-16930	12 x 12 x 2"	Picture Frames	2.26	2.10	1.64	1.61	50
S-16931	12 x 12 x 4"	Picture Frames	2.98	2.75	2.25	2.18	50
S-16934	12 x 12 x 6"	Picture Frames	3.86	3.57	2.92	2.82	25
S-16935	12 1/2 x 9 1/4 x 2"	Booklets, Calendars	1.98	1.84	1.38	1.32	50
S-16936	12 1/2 x 9 1/4 x 3"	Oversized Catalogs	2.18	2.04	1.57	1.52	50
S-16952	12 1/2 x 9 1/4 x 4"	Oversized Catalogs	2.69	2.53	2.04	1.97	50
S-16937	13 x 10 x 2"	Envelopes	2.04	1.90	1.44	1.40	50
S-16938	13 x 10 x 4"	Envelopes	2.88	2.68	2.16	2.10	50
S-16957	13 x 13 x 3"	Product Samples	2.82	2.64	2.14	2.08	50
S-16932	14 x 10 x 3"	File Folders, Calendars	2.75	2.57	2.08	2.02	50
S-16958	14 x 10 x 4"	File Folders, Calendars	3.32	3.11	2.50	2.40	50
S-16927	14 x 10 x 6"	File Folders, Calendars	4.68	4.40	3.58	3.52	50
S-16960	15 1/2 x 11 1/2 x 2"	Clothing	2.39	2.22	1.79	1.71	50
S-16919	15 1/2 x 11 1/2 x 4"	Clothing	3.00	2.82	2.40	2.34	50
S-16933	16 x 10 x 2 3/4"	Photos, Prints	2.76	2.55	2.07	2.01	50
S-16961	16 x 12 x 2"	Books	2.38	2.21	1.75	1.71	50
S-16924	16 x 12 x 4"	Books	3.35	3.14	2.53	2.44	50
S-16920	16 x 16 x 2 3/4"	Oversized Calendars	3.17	2.91	2.30	2.21	50
S-16962	18 x 12 x 2"	Books	2.43	2.29	1.85	1.81	25
S-16959	18 x 12 x 3"	Books	2.98	2.72	2.18	2.13	25
S-16963	18 x 12 x 4"	Books	3.82	3.53	2.73	2.67	25
■ S-21616	18 x 12 x 6"	Books	5.07	4.76	3.89	3.75	25
S-16928	18 x 14 x 4"	Product Samples	4.01	3.71	2.98	2.90	25
S-16965	19 x 12 x 3"	Promotional Materials	3.19	2.92	2.43	2.36	25
S-16964	20 x 16 x 2 1/2"	Prints	3.55	3.23	2.60	2.54	25
■ S-16966	20 x 20 x 4"	Suits, Dresses	5.35	5.05	4.20	4.09	25
S-16967	22 x 18 x 2 3/4"	Promotional Materials	4.21	3.98	3.32	3.19	25
S-16968	24 x 14 x 4"	Pants, Blazers	4.38	4.20	3.52	3.41	25

■ SHIPS VIA MOTOR FREIGHT

## CARRYING CASES



S-13485

Easily carry your product, literature and samples.

- Holds up to 7 lbs.
- Sturdy plastic handle.
- 200 lb. test.

MODEL NO.	INSIDE DIMENSIONS L x W x H	PRICE EACH (SOLD IN BUNDLE QTYS.)					QTY./ BNDL.
		20	100	300	500	1,000+	
S-13485	12 1/2 x 9 1/4 x 3"	\$2.55	\$2.39	\$2.30	\$2.18	\$2.08	
S-3272	18 1/4 x 11 3/8 x 2 11/16"	3.41	3.19	2.98	2.88	2.71	
S-3273	18 1/4 x 11 3/8 x 4 1/2"	4.34	4.07	3.89	3.72	3.57	20
S-11226	20 x 11 3/8 x 5 1/2"	5.33	5.12	4.84	4.68	4.51	
S-13486	24 x 14 x 4"	5.46	5.18	4.91	4.72	4.61	

# WHITE TAB LOCKING LITERATURE MAILERS

MODEL NO.	INSIDE DIMENSIONS L x W x H	SUGGESTED USE	PRICE EACH (SOLD IN BUNDLE QTYS.)				QTY./BNDL.
			25-50	100	500	1,000+	
S-7761*	5 7/8 x 4 3/16 x 5"	10 CD Mailer	\$1.96	\$1.81	\$1.49	\$1.32	50
S-9841*	7 7/8 x 5 7/16 x 3 3/16"	6 DVD Mailer	2.01	1.85	1.53	1.49	50
S-8074*	7 7/8 x 6 x 5 7/16"	10 DVD Mailer	2.26	2.16	1.85	1.81	50
S-3183	8 x 8 x 2 3/4"	Small Frames	1.44	1.38	1.11	1.06	50
S-8296	9 x 6 1/2 x 2 3/4"	Digest Size Books	1.38	1.28	1.01	.98	50
S-9842	9 x 6 1/2 x 4"	Digest Size Books	2.05	1.96	1.62	1.58	50
S-16676	10 x 10 x 3"	Catalogs, Books	2.11	2.01	1.64	1.61	50
S-14220	10 x 10 x 4"	Catalogs, Books	2.38	2.22	1.92	1.85	50
S-9843	10 x 10 x 5"	Catalogs, Books	3.02	2.85	2.32	2.22	50
S-6492*	10 5/16 x 5 x 5 5/16"	25 CD Mailer	2.48	2.38	1.96	1.70	50
S-8341	11 1/8 x 8 3/4 x 2"	Letter Size	1.74	1.61	1.19	1.17	50
S-11227	11 1/8 x 8 3/4 x 3"	Stationery	2.05	1.91	1.50	1.46	50
S-3184	11 1/8 x 8 3/4 x 4"	Letter Size	2.38	2.18	1.74	1.70	50
S-9844	11 3/4 x 10 3/4 x 2 1/4"	1" & 1 1/2" Tall Binders	2.18	2.04	1.63	1.60	50
S-7869	12 x 8 x 2 3/4"	Framed Pictures	2.02	1.88	1.49	1.44	50
S-16677	12 x 10 x 4"	File Folders	2.85	2.68	2.16	2.10	50
S-13278	12 x 10 x 6"	File Folders	3.83	3.55	2.92	2.82	50
S-2735	12 x 11 x 3"	2" Ring Binders	2.40	2.25	1.81	1.74	50
S-13279	12 x 12 x 2"	Picture Frames	2.38	2.21	1.74	1.70	50
S-16678	12 x 12 x 3"	Picture Frames	2.75	2.57	2.07	2.01	50
S-8297	12 x 12 x 4"	Picture Frames	3.13	2.92	2.38	2.30	50
S-11228	12 x 12 x 6"	Picture Frames	4.05	3.77	3.09	2.98	25
S-9845	12 1/2 x 9 1/4 x 2"	Booklets, Calendars	2.08	1.94	1.44	1.40	50
S-11229	12 1/2 x 9 1/4 x 3"	Oversized Catalogs	2.32	2.16	1.63	1.60	50
S-6714	12 1/2 x 9 1/4 x 4"	Oversized Catalogs	2.85	2.64	2.16	2.10	50
S-14221	12 1/2 x 9 1/4 x 6"	Oversized Catalogs	3.72	3.54	2.88	2.76	50
S-15148	13 x 10 x 2"	Envelopes	2.16	1.97	1.53	1.49	50
S-13280	13 x 10 x 4"	Envelopes	3.00	2.82	2.26	2.18	50
S-16948	13 x 13 x 3"	Product Samples	2.98	2.79	2.25	2.18	50
S-13281	14 x 10 x 3"	File Folders, Calendars	2.92	2.69	2.18	2.14	50
S-3699	14 x 10 x 4"	File Folders, Calendars	3.52	3.25	2.60	2.54	50
S-12769	14 x 10 x 6"	File Folders, Calendars	4.92	4.66	3.79	3.69	50
S-16679	14 x 14 x 4"	Large Photos, Prints	4.21	3.98	3.17	3.10	50
S-2736	15 1/8 x 11 1/8 x 2"	Clothing	2.53	2.36	1.91	1.84	50
S-11230	15 1/8 x 11 1/8 x 4"	Clothing	3.14	2.98	2.54	2.48	50
S-3186	16 x 10 x 2 3/4"	Photos, Prints	2.92	2.68	2.17	2.11	50
S-22133	16 x 12 x 2"	Books	2.51	2.34	1.85	1.81	50
S-15149	16 x 12 x 4"	Books	3.55	3.32	2.64	2.57	50
■ S-16949	16 x 12 x 6"	Books	5.12	4.79	3.93	3.79	25
S-7870	16 x 16 x 2 3/4"	Oversized Calendars	3.33	3.02	2.40	2.34	50
S-9846	17 1/4 x 11 1/4 x 4"	Expandable Files	3.99	3.67	2.88	2.76	25
S-11231	18 x 12 x 2"	Books	2.55	2.39	1.95	1.90	25
S-2737	18 x 12 x 3"	Books	3.13	2.88	2.30	2.21	25
S-12770	18 x 12 x 4"	Books	4.01	3.71	2.91	2.80	25
■ S-16680	18 x 12 x 6"	Books	5.35	5.02	4.09	3.97	25
S-21617	18 x 14 x 4"	Product Samples	4.22	3.90	3.14	3.03	25
S-14222	19 x 12 x 3"	Promotional Materials	3.34	3.03	2.55	2.49	25
S-6496	19 1/8 x 9 1/8 x 2 3/16"	Keyboard	3.40	3.20	2.90	2.80	25
■ S-2738	20 x 20 x 4"	Suits, Dresses	5.64	5.32	4.40	4.27	25
S-7871	22 x 18 x 2 3/4"	Promotional Materials	4.47	4.18	3.52	3.40	25
S-2739	24 x 14 x 4"	Pants, Blazers	4.61	4.40	3.67	3.56	25
■ S-21618	24 x 18 x 4"	Picture Frames	5.60	5.26	4.38	4.22	25
■ S-16681	24 x 18 x 6"	Large Picture Frames	7.45	7.01	5.84	5.65	25

\* Slightly different than pictured

■ SHIPS VIA MOTOR FREIGHT



S-3184

- Avoid custom prices. Our stock sizes fit all your needs.
- 200 lb. test.



Front lock tabs for added security.

S-2737



S-3699

Colored Mailers available, see page 173.



# INDESTRUCTO MAILERS

HEAVY DUTY

Guaranteed protection for your most fragile items.

- Recommended for tools, small parts, nuts and bolts, glassware and other small items.
- **CRUSHPROOF** – Triple wall sides and double wall front and bottom.
- Assembles without tape or glue.
- 200 lb. test.



**LARGER QUANTITIES  
CALL FOR QUOTE**

MODEL NO.	INSIDE DIM. L x W x H	PRICE PER 100				QTY./ BNDL.	LBS./ 100
		100	300	500	1,000+		
S-435	3 x 2 x 2"	\$35	\$33	\$29	\$28	100	6
S-409	3 x 3 x 1"	43	41	35	33	100	7
S-424	3 x 3 x 2"	44	42	39	34	100	8
S-438	3 x 3 x 3"	58	50	43	41	100	10
S-492	4 x 2 x 2"	41	34	33	29	100	7
S-15073	4 x 3 x 1"	44	42	39	34	100	7
S-425	4 x 3 x 2"	45	43	41	35	100	9
S-417	4 x 3 x 3"	60	54	44	42	100	12
S-11232	4 x 4 x 1"	61	55	45	43	100	9
S-460	4 x 4 x 2"	64	58	52	44	100	12
S-426	4 x 4 x 3"	71	64	58	55	100	15
S-1719	4 x 4 x 4"	86	72	66	60	100	18
S-436	4 3/8 x 4 3/8 x 2"	71	64	58	55	100	13
S-440	4 3/8 x 4 3/8 x 2 1/2"	80	69	64	58	100	14
S-466	4 3/8 x 4 3/8 x 3 1/2"	92	80	71	66	100	18
S-467	5 x 2 x 2"	44	42	39	34	100	8
S-16519	5 x 3 x 1"	50	43	41	35	100	10
S-461	5 x 3 x 2"	55	45	42	39	100	11
S-418	5 x 3 x 3"	62	56	50	44	100	14
S-463	5 x 4 x 2"	67	60	56	50	100	14
S-428	5 x 4 x 3"	80	69	64	58	100	17
S-1720	5 x 4 x 4"	92	80	71	66	100	18
S-14291	5 x 5 x 1"	87	77	69	64	100	12
S-11233	5 x 5 x 2"	93	83	71	66	100	15
S-464	5 x 5 x 3"	100	87	77	71	100	20
S-1721	5 x 5 x 4"	106	98	90	77	100	22
S-9853	5 x 5 x 5"	122	105	100	87	100	23
S-468	5 1/2 x 3 1/2 x 3 1/2"	85	71	65	60	100	17
S-473	6 x 2 x 2"	48	43	39	34	100	9
S-959	6 x 2 1/2 x 2 3/8"	56	48	43	41	100	12
S-429	6 x 3 x 2"	58	50	44	42	100	12
S-961	6 x 3 x 3"	66	60	55	45	100	16
S-960	6 x 3 3/8 x 2"	69	62	56	54	100	12
S-16521	6 x 4 x 1"	67	61	55	52	100	13

MODEL NO.	INSIDE DIM. L x W x H	PRICE PER 100				QTY./ BNDL.	LBS./ 100
		100	300	500	1,000+		
S-419	6 x 4 x 2"	\$72	\$64	\$60	\$55	100	15
<b>S-430</b>	<b>6 x 4 x 3"</b>	<b>57</b>	<b>57</b>	<b>57</b>	<b>57</b>	<b>100</b>	<b>19</b>
S-1722	6 x 4 x 4"	96	86	72	67	100	22
S-16522	6 x 5 x 1"	90	80	71	65	100	15
S-13359	6 x 5 x 2"	96	86	72	67	100	17
S-10695	6 x 5 x 3"	117	105	98	93	100	22
S-13360	6 x 5 x 4"	123	112	104	100	100	26
S-15074	6 x 5 x 5"	129	118	111	104	100	28
S-3061	6 x 6 x 1"	117	106	101	94	100	19
S-8264	6 x 6 x 2"	123	112	102	98	100	22
S-3385	6 x 6 x 3"	133	119	112	105	100	24
S-8265	6 x 6 x 4"	139	128	118	106	100	27
S-15075	6 x 6 x 5"	149	136	123	117	100	29
S-10696	6 x 6 x 6"	157	142	129	122	100	31
S-966	6 1/2 x 3 5/8 x 2 1/2"	72	64	60	55	100	16
S-967	6 1/2 x 4 1/2 x 2 1/2"	92	80	71	66	100	19
S-968	6 1/2 x 4 7/8 x 2 5/8"	96	85	72	67	100	21
S-420	6 1/2 x 4 7/8 x 3 3/4"	112	100	92	85	100	25
S-807	7 x 2 x 2"	52	44	41	35	100	10
S-16523	7 x 3 x 1"	55	50	42	39	100	11
S-969	7 x 3 x 2"	60	54	44	42	100	13
S-970	7 x 3 x 3"	69	62	56	54	100	17
S-16524	7 x 4 x 1"	72	65	60	55	100	15
S-465	7 x 4 x 2"	80	69	64	58	100	17
S-431	7 x 4 x 3"	90	77	69	64	100	21
S-1723	7 x 4 x 4"	100	87	80	71	100	23
S-21591	7 x 5 x 1"	93	84	75	66	100	16
S-11234	7 x 5 x 2"	104	94	86	77	100	18
S-16525	7 x 5 x 3"	118	106	101	96	100	24
S-971	7 x 5 x 4"	125	115	105	101	100	29
S-11235	7 x 5 x 5"	138	125	118	106	100	31
S-20996	7 x 6 x 2"	124	114	104	100	100	23
S-16526	7 x 6 x 3"	133	123	115	105	100	27
S-14292	7 x 7 x 3"	162	149	136	128	100	30

# INDESTRUCTO MAILERS



**CRUSHPROOF** – Triple wall sides and double wall front and bottom.

**SAVES SPACE** – Ships and stores flat.



**LARGER QUANTITIES CALL FOR QUOTE**

MODEL NO.	INSIDE DIM. L x W x H	PRICE PER 100				QTY./ BNDL.	LBS./ 100
		100	300	500	1,000+		
S-15076	7 x 7 x 4"	\$184	\$164	\$152	\$142	100	37
S-13361	7 x 7 x 5"	201	184	164	152	100	41
S-15077	7 x 7 x 6"	210	194	173	160	100	46
S-15078	7 x 7 x 7"	219	202	181	164	100	51
S-421	7 1/8 x 5 x 3"	123	112	104	100	100	26
S-973	7 1/2 x 3 1/2 x 3 1/4"	80	69	64	58	100	21
S-15079	8 x 2 x 2"	58	50	44	41	100	11
S-974	8 x 3 x 2"	66	60	55	45	100	14
S-975	8 x 3 x 3"	86	72	66	60	100	18
S-976	8 x 4 x 2"	87	77	67	62	100	18
S-808	8 x 4 x 3"	100	87	77	69	100	22
S-432	8 x 4 x 4"	105	94	87	75	100	27
S-16527	8 x 5 x 1"	96	87	82	72	100	18
S-15080	8 x 5 x 2"	115	104	96	86	100	21
S-13362	8 x 5 x 3"	125	115	105	101	100	26
S-10697	8 x 5 x 4"	136	124	117	106	100	30
S-15085	8 x 5 x 5"	144	134	123	115	100	34
S-16528	8 x 6 x 1"	118	110	102	96	100	20
S-13363	8 x 6 x 2"	125	115	105	101	100	24
S-10698	8 x 6 x 3"	128	118	110	104	100	31
<b>S-3697</b>	<b>8 x 6 x 4"</b>	<b>126</b>	<b>126</b>	<b>126</b>	<b>126</b>	<b>50</b>	<b>35</b>
S-15086	8 x 6 x 5"	162	152	143	134	100	39
S-11236	8 x 6 x 6"	174	162	152	142	100	42
S-16529	8 x 7 x 2"	142	129	119	112	100	29
S-18160	8 x 7 x 4"	165	154	144	136	100	39
S-15087	8 x 7 x 6"	175	163	153	143	100	49
S-12662	8 x 8 x 2"	144	134	123	117	100	33
S-13364	8 x 8 x 3"	161	150	139	129	100	36
S-10701	8 x 8 x 4"	173	161	150	139	100	43
S-15088	8 x 8 x 5"	175	163	153	143	100	48
S-9854	8 x 8 x 6"	179	164	157	144	100	53
S-11238	8 x 8 x 8"	191	174	163	153	100	64
S-14308	9 x 2 x 2"	59	52	44	42	100	12
S-15089	9 x 3 x 2"	75	66	60	55	100	15

MODEL NO.	INSIDE DIM. L x W x H	PRICE PER 100				QTY./ BNDL.	LBS./ 100
		100	300	500	1,000+		
S-809	9 x 3 x 3"	\$87	\$75	\$67	\$62	100	20
S-13366	9 x 4 x 2"	92	85	71	66	100	19
S-433	9 x 4 x 3"	101	90	80	71	100	24
S-1724	9 x 4 x 4"	112	100	92	85	100	28
S-15090	9 x 5 x 2"	104	92	85	75	100	23
S-10699	9 x 5 x 3"	111	98	90	80	100	26
S-15091	9 x 5 x 4"	134	122	111	104	100	32
S-13367	9 x 5 x 5"	139	128	119	111	100	37
S-16530	9 x 6 x 1"	123	112	105	100	100	23
S-15092	9 x 6 x 2"	125	117	106	102	100	26
S-13368	9 x 6 x 3"	136	123	112	105	100	31
S-12663	9 x 6 x 4"	143	133	123	115	100	36
S-15093	9 x 6 x 5"	153	142	133	122	100	42
S-15094	9 x 6 x 6"	171	158	146	136	100	47
S-15095	9 x 7 x 4"	146	136	128	117	100	41
S-16531	9 x 8 x 5"	205	192	175	162	100	51
S-18161	9 x 9 x 4"	226	210	196	179	50	49
S-843	10 x 2 x 2"	60	54	45	43	100	13
S-844	10 x 3 x 2"	69	62	56	54	100	19
S-845	10 x 3 x 3"	92	80	71	66	100	20
S-978	10 x 4 x 2"	94	86	72	67	100	20
S-979	10 x 4 x 3"	112	100	92	85	100	25
S-434	10 x 4 x 4"	119	105	98	90	100	30
S-439	10 x 4 1/2 x 3 3/4"	134	119	106	101	100	33
S-16532	10 x 5 x 2"	119	105	98	90	100	26
S-15097	10 x 5 x 3"	122	106	101	92	100	29
S-16533	10 x 5 x 4"	140	128	119	111	100	32
S-10700	10 x 5 x 5"	142	129	122	112	100	39
S-13369	10 x 6 x 2"	140	128	119	111	100	28
S-15098	10 x 6 x 3"	142	129	122	112	100	33
S-10702	10 x 6 x 4"	144	134	125	117	100	41
S-9855	10 x 6 x 6"	175	163	154	144	100	50
S-22106	10 x 7 x 3"	161	149	142	126	100	38
S-18162	10 x 7 x 4"	169	157	150	138	100	45

# INDESTRUCTO MAILERS

(CONTINUED FROM PAGE 83)



MODEL NO.	INSIDE DIM. L x W x H	PRICE PER 100				QTY./BNDL.	LBS./100
		100	300	500	1,000+		
S-16534	10 x 7 x 6"	\$190	\$173	\$162	\$153	100	55
S-18207	10 x 8 x 2"	164	153	143	136	100	37
S-16535	10 x 8 x 4"	175	163	154	144	100	48
S-16536	10 x 8 x 5"	191	174	163	154	100	51
S-10703	10 x 8 x 6"	194	179	165	158	100	61
S-16537	10 x 8 x 8"	237	218	204	195	50	75
S-16538	10 x 10 x 2"	232	215	197	181	100	49
S-15099	11 x 4 x 4"	122	105	100	92	100	31
S-16539	11 x 5 x 5"	149	138	128	118	100	43
S-16540	11 x 8 x 2"	179	164	153	140	100	41
S-14309	11 x 8 x 4"	188	171	160	146	100	52
S-443	11½ x 3½ x 3½"	112	100	92	85	100	27
S-16541	12 x 2 x 2"	67	61	56	52	100	15
S-980	12 x 3½ x 3"	106	98	90	77	100	25
S-10704	12 x 4 x 2"	112	100	92	85	100	26
S-16542	12 x 4 x 3"	118	104	96	87	100	29
S-1725	12 x 4 x 4"	123	105	100	92	100	32
S-15100	12 x 5 x 4"	142	133	123	112	100	38
S-16543	12 x 5 x 5"	154	142	134	124	100	45

MODEL NO.	INSIDE DIM. L x W x H	PRICE PER 100				QTY./BNDL.	LBS./100
		100	300	500	1,000+		
S-14310	12 x 6 x 2"	\$139	\$125	\$117	\$105	100	32
S-15101	12 x 6 x 3"	143	129	118	106	100	38
S-8266	12 x 6 x 4"	144	134	124	117	100	45
S-9856	12 x 6 x 6"	184	170	160	149	100	57
S-14311	12 x 9 x 2"	218	202	188	170	100	43
S-16544	12 x 9 x 3"	233	215	197	179	100	52
S-13370	12 x 9 x 4"	250	225	207	190	100	60
S-16545	12 x 9 x 6"	296	268	249	222	50	75
S-446	13½ x 3½ x 3½"	119	105	98	90	100	31
S-16546	14 x 3 x 3"	112	101	93	86	100	28
S-16547	14 x 4 x 2"	118	104	96	87	100	29
S-3698	14 x 4 x 4"	142	128	118	106	100	38
S-22105	14 x 6 x 2"	154	139	131	122	100	39
S-12664	14 x 6 x 4"	162	144	136	128	100	48
S-15102	15 x 2 x 2"	85	71	66	61	100	17
S-16548	15 x 7 x 5"	202	192	169	162	50	67
S-3386	16 x 4 x 4"	181	162	150	143	100	40
S-16549	16 x 5 x 5"	184	163	153	144	100	52
S-13365	16 x 6 x 4"	192	171	161	153	100	53
S-10705	16 x 6 x 6"	196	175	163	158	100	65
S-15103	17 x 6 x 6"	207	194	173	165	50	68
S-981	17½ x 3½ x 3½"	138	123	111	100	50	42
S-14312	18 x 4 x 4"	158	142	133	125	50	42
■ S-16550	18 x 12 x 4"	407	383	355	321	50	95
S-21570	20 x 4 x 4"	184	163	153	146	50	48
S-15104	21 x 6 x 2"	185	164	154	146	100	46
S-15105	22 x 6 x 2"	190	165	158	150	100	47
S-15106	24 x 2 x 2"	118	104	98	87	100	25
S-2671	24 x 4 x 4"	188	164	157	149	50	57
S-15107	26 x 6 x 2"	205	190	171	164	50	54
S-846	27½ x 3½ x 3½"	190	165	158	150	50	52
S-2672	30 x 4 x 4"	268	237	216	196	50	69
S-15108	36 x 4 x 4"	288	253	230	208	50	74
S-847	36¼ x 4¾ x 4"	296	260	237	216	50	85

■ SHIPS VIA MOTOR FREIGHT



## LAPTOP MAILERS

Ship your laptops safely.

- Front lock tabs provide extra security.
- Anti-static foam protects your stored memory.

More Anti-Static Shippers, see page 749

MODEL NO.	FITS MAX. SIZE L x W x H	PRICE PER MAILER					QTY./CASE
		4	12	48	72	96+	
S-7961	12½ x 10½ x 2½"	\$18.30	\$17.40	\$16.90	\$16.40	\$16.30	4
S-9885	16½ x 12½ x 2½"	27.50	26.40	25.90	25.50	25.10	



# KRAFT INDESTRUCTO MAILERS

Superior protection for your valuable items.

- Rugged kraft construction for a more industrial look.
- Conceals fingerprints, grease and shipping grime.
- 200 lb. test.
- Triple wall sides and double wall front and bottom.



MODEL NO.	INSIDE DIM. L x W x H	PRICE PER 100				QTY./ BNDL.	LBS./ 100
		100	300	500	1,000+		
S-18145	3 x 3 x 2"	\$42	\$39	\$37	\$33	100	8
S-20500	3 x 3 x 3"	55	46	41	37	100	10
S-16610	4 x 3 x 2"	43	42	39	34	100	9
S-20501	4 x 3 x 3"	56	50	42	39	100	12
S-18146	4 x 4 x 1"	58	52	43	41	100	9
S-16611	4 x 4 x 2"	61	55	48	42	100	12
S-20997	4 x 4 x 3"	66	60	55	52	100	15
S-16612	4 x 4 x 4"	82	67	62	56	100	18
S-16613	5 x 3 x 2"	52	43	41	37	100	11
S-20502	5 x 3 x 3"	60	54	46	42	100	14
S-20998	5 x 4 x 2"	64	56	54	46	100	14
S-18147	5 x 4 x 3"	71	65	60	55	100	17
S-21612	5 x 4 x 4"	85	75	66	62	100	18
S-22107	5 x 5 x 1"	83	73	65	60	100	12
S-20503	5 x 5 x 2"	86	79	66	64	100	15
S-18148	5 x 5 x 3"	94	84	71	67	100	20
S-16614	5 x 5 x 4"	102	92	84	71	100	22
S-20504	5 x 5 x 5"	115	100	93	83	100	23
S-22108	6 x 2 x 2"	45	41	35	32	100	9
S-18149	6 x 3 x 2"	55	45	42	39	100	12
S-22109	6 x 3 x 3"	62	56	53	43	100	16
S-22611	6 x 4 x 1"	64	56	53	48	100	13
S-16615	6 x 4 x 2"	67	61	56	52	100	15
S-16616	6 x 4 x 3"	75	65	62	56	100	19
S-18150	6 x 4 x 4"	93	82	69	65	100	22
S-22612	6 x 5 x 2"	90	80	68	65	100	17
S-18958	6 x 5 x 3"	110	101	93	87	100	22
S-16617	6 x 6 x 2"	112	105	100	93	100	22
S-20505	6 x 6 x 3"	124	114	105	101	100	24
S-18959	6 x 6 x 4"	129	119	111	102	100	27
S-21613	6 x 6 x 6"	147	133	122	114	100	31
S-18151	7 x 3 x 3"	65	60	54	50	100	17
S-18152	7 x 4 x 2"	71	65	60	55	100	17
S-18153	7 x 4 x 3"	85	71	66	61	100	21
S-20506	7 x 4 x 4"	94	84	71	66	100	23
S-20507	7 x 5 x 2"	98	90	83	71	100	18
S-22613	7 x 5 x 3"	112	98	93	85	100	23

MODEL NO.	INSIDE DIM. L x W x H	PRICE PER 100				QTY./ BNDL.	LBS./ 100
		100	300	500	1,000+		
S-18154	7 x 5 x 4"	\$119	\$106	\$101	\$96	100	29
S-22110	7 x 6 x 3"	124	116	106	100	100	27
S-22614	7 x 7 x 3"	152	140	127	122	100	30
S-22615	7 x 7 x 4"	173	154	143	133	100	37
S-22616	8 x 3 x 2"	62	55	52	43	100	14
S-22617	8 x 3 x 3"	82	68	62	55	100	18
S-16618	8 x 4 x 2"	84	69	64	60	100	18
S-18960	8 x 4 x 3"	94	84	71	66	100	22
S-16619	8 x 4 x 4"	101	90	84	69	100	27
S-18155	8 x 6 x 2"	118	106	102	96	100	24
S-20999	8 x 6 x 3"	119	111	104	98	100	28
S-16620	8 x 6 x 4"	158	144	138	123	50	35
S-22111	8 x 8 x 4"	162	152	142	131	100	43
S-22618	8 x 8 x 6"	168	154	147	136	100	53
S-22112	9 x 3 x 3"	83	71	64	60	100	20
S-18156	9 x 4 x 3"	94	85	72	66	100	24
S-22619	9 x 4 x 4"	105	93	86	80	100	28
S-21614	9 x 6 x 2"	119	110	104	98	100	26
S-16621	9 x 6 x 3"	124	112	105	100	100	31
S-22620	9 x 6 x 4"	134	122	114	105	100	36
S-22113	9 x 7 x 4"	138	126	122	111	100	41
S-18961	10 x 4 x 2"	90	82	69	65	100	20
S-18157	10 x 4 x 4"	112	101	93	85	100	30
S-22621	10 x 5 x 3"	115	101	95	87	100	29
S-16622	10 x 5 x 5"	134	122	112	105	100	39
S-21615	10 x 6 x 4"	136	123	115	106	100	41
S-18962	10 x 7 x 3"	152	140	134	119	100	38
S-22622	10 x 7 x 4"	159	147	138	127	100	45
S-18158	12 x 4 x 4"	117	102	94	86	100	32
S-18159	12 x 6 x 4"	139	124	117	110	100	45
S-16623	12 x 6 x 6"	171	161	150	139	100	57
S-18963	12 x 9 x 2"	207	192	174	161	100	43
S-22623	12 x 9 x 3"	220	202	185	169	100	52
S-21000	12 x 9 x 4"	234	211	195	179	100	60
S-22624	12 x 9 x 6"	278	253	234	210	50	75
S-16624	14 x 4 x 4"	133	119	110	102	100	42
S-22114	16 x 4 x 4"	171	153	142	136	100	40

# KRAFT TUBES



**OVER 80 SIZES –  
IN STOCK SHIPS TODAY**

MODEL NO.	INSIDE DIAMETER	USABLE LENGTH	THICKNESS	TUBES/ CTN.	LBS./ CTN.	PRICE EACH (SOLD IN CARTON QTYS.)				
						25-50	100	250	500	1,000+
S-5812	1½"	6"	.060	50	7	\$.83	\$.77	\$.74	\$.71	\$.65
S-5813		9"	.060	50	8	1.02	.96	.87	.78	.75
S-5572		12"	.060	50	8	1.05	1.01	.96	.85	.78
S-5814		15"	.060	50	11	1.10	1.05	1.01	.96	.85
S-3935		18"	.060	50	11	1.13	1.10	1.05	1.01	.93
S-8130		20"	.060	50	12	1.19	1.12	1.09	1.03	.99
S-3612		24"	.060	50	14	1.30	1.23	1.13	1.10	1.05
S-8131		26"	.060	50	15	1.38	1.28	1.20	1.12	1.09
S-5815		30"	.060	50	17	1.50	1.43	1.34	1.24	1.16
S-5816		36"	.060	50	22	1.72	1.61	1.52	1.47	1.38
S-14046	48"	.060	50	30	2.18	1.97	1.84	1.74	1.61	
S-7012	2"	6"	.060	50	8	.96	.88	.81	.76	.73
S-2973		12"	.060	50	14	\$.81 each any carton quantity				
S-3936		15"	.060	50	15	1.16	1.11	1.01	.97	.86
S-2638		18"	.060	50	15	1.20	1.12	1.05	1.02	.97
S-3125		20"	.060	50	18	1.25	1.16	1.09	1.05	1.01
S-11977		22"	.060	50	20	1.34	1.25	1.13	1.10	1.05
S-2639		24"	.060	50	22	\$.1.09 each any carton quantity				
S-8132		25"	.070	50	23	1.43	1.33	1.20	1.13	1.11
S-3937		26"	.070	50	24	1.47	1.40	1.24	1.16	1.12
S-2640		30"	.070	50	28	1.62	1.52	1.47	1.39	1.30
S-2641	36"	.070	50	34	1.87	1.77	1.65	1.56	1.48	
S-3938	43"	.080	50	37	2.37	2.26	2.17	2.00	1.88	
S-3944	48"	.080	50	40	2.69	2.52	2.30	2.16	2.02	
■S-13747	60"	.080	50	56	3.44	3.29	3.08	2.96	2.92	
■S-14047	72"	.080	50	67	3.81	3.61	3.36	3.25	3.09	
S-3939	2½"	12"	.060	35	9	1.33	1.25	1.16	1.10	1.03
S-12003		15"	.060	35	11	1.38	1.28	1.23	1.13	1.09
S-3940		18"	.060	35	15	1.44	1.36	1.30	1.20	1.13
S-3941		20"	.060	35	18	1.48	1.43	1.34	1.24	1.16
S-2974		24"	.070	35	20	1.62	1.55	1.47	1.38	1.30
S-3942		26"	.070	35	21	1.71	1.62	1.55	1.48	1.38
S-2975		30"	.070	35	22	1.88	1.83	1.72	1.62	1.55
S-3943		36"	.080	35	24	2.32	2.21	2.11	1.97	1.86
S-3613	3"	6"	.060	50	11	1.23	1.13	1.09	1.03	.97
S-6240		9"	.060	25	9	1.44	1.33	1.19	1.11	1.09
S-3614		12"	.060	25	10	1.67	1.55	1.34	1.24	1.13

■ SHIPS VIA MOTOR FREIGHT

Mail documents, posters and hard goods safely.

- Rigid tubes are 3-ply spiral wound.
- Tube sizes are inside dimensions.
- Plastic end caps fit tight – Protect your shipment.
- Plastic end caps included. See page 90 for additional caps.

**QUICK CUSTOM TUBES** – See [uline.com](http://uline.com)

- 275 additional sizes available, including 96" and 108" long.
- Ships in 1-3 days from Illinois.



**CAN'T FIND YOUR SIZE?** Call our Quotes Department – 1-888-952-6937.

- Available from 1 to 12" in diameter.
- 250-piece minimum.
- Ships in 2-5 days.

**CORES AVAILABLE**

- Tubes without caps can be used to protect and store industrial parts, rods and fabrics.

**NEED LARGER QUANTITIES?**

- Volume discounts available.

# KRAFT TUBES CONTINUED

MODEL NO.	INSIDE DIAMETER	USABLE LENGTH	THICKNESS	TUBES/CTN.	LBS./CTN.	PRICE EACH (SOLD IN CARTON QTYS.)					
						15-25	100	250	500	1,000+	
S-5573	3"	15"	.060	25	10	\$1.70	\$1.58	\$1.40	\$1.33	\$1.19	
S-12031		16"	.070	25	11	1.71	1.59	1.43	1.34	1.20	
S-2642		18"	.070	25	15	1.74	1.61	1.46	1.38	1.27	
S-7013		20"	.070	25	16	1.77	1.62	1.48	1.43	1.30	
S-2643		24"	.070	25	17	\$1.38 each any carton quantity					
S-14048		24"	.125	25	30	3.54	3.43	3.17	3.10	3.07	
S-8133		25"	.080	25	18	1.83	1.74	1.58	1.50	1.44	
S-3126		26"	.080	25	19	\$1.52 each any carton quantity					
S-12038		28"	.080	25	20	2.23	2.13	1.92	1.81	1.75	
S-2644		30"	.080	25	21	2.26	2.17	1.96	1.85	1.79	
S-2645		36"	.080	25	22	\$1.99 each any carton quantity					
S-14049		36"	.125	25	34	3.68	3.44	3.21	3.12	3.05	
S-12046		38"	.080	25	23	2.80	2.69	2.50	2.36	2.22	
S-3615		42"	.080	25	24	3.02	2.82	2.70	2.56	2.39	
S-3388		48"	.080	25	27	3.33	3.12	2.96	2.80	2.61	
S-6241		56"	.125	25	56	5.59	5.51	5.44	5.12	4.82	
■S-5574		60"	.125	25	60	5.90	5.80	5.71	5.38	5.01	
S-7014		72"	.125	15	52	8.74	8.61	8.39	7.93	7.40	
S-6242		4"	12"	.080	25	20	2.17	2.11	2.00	1.88	1.79
S-10722			18"	.080	25	20	2.72	2.56	2.26	2.11	1.98
S-12086	20"		.080	25	22	2.78	2.58	2.33	2.21	2.06	
S-3616	24"		.080	25	25	3.09	2.90	2.63	2.45	2.30	
S-6243	26"		.080	25	30	3.21	3.02	2.70	2.58	2.39	
S-3617	30"		.080	25	36	3.44	3.19	2.88	2.72	2.52	
S-3573	36"		.080	25	38	\$2.68 each any carton quantity					
■S-3618	42"		.080	25	41	4.16	3.99	3.82	3.67	3.57	
■S-3127	48"		.080	25	42	5.39	5.15	4.95	4.65	4.38	
■S-12116	56"		.125	25	73	7.35	7.13	6.87	6.48	6.03	
■S-5575	60"		.125	25	75	7.66	7.30	7.02	6.73	6.41	
■S-11336	72"		.125	15	48	10.81	9.80	9.37	9.26	9.12	

■ SHIPS VIA MOTOR FREIGHT



- Largest selection of mailing tubes in stock.
- Store, protect and preserve your product.
- Need a larger quantity? For volume discounts, call our Quotes Department – 1-888-952-6937.

**EXTRA PLASTIC END CAPS**  
Available in Black and White.  
See page 90.

# JUMBO KRAFT TUBES

MODEL NO.	INSIDE DIAMETER	USABLE LENGTH	THICKNESS	TUBES/CTN.	LBS./CTN.	PRICE EACH (SOLD IN CARTON QTYS.)				
						8-15	100	250	500	1,000+
S-10723	5"	24"	.125	15	24	\$5.63	\$5.53	\$5.44	\$5.10	\$4.66
S-12125		26"	.125	15	24	5.84	5.71	5.61	5.24	4.83
S-10690		30"	.125	15	30	6.15	6.00	5.92	5.52	5.17
S-6244		36"	.125	15	38	7.03	6.91	6.76	6.32	5.84
■S-8098		48"	.125	15	42	9.87	9.65	9.41	8.81	8.10
■S-8099		60"	.125	15	60	12.68	12.32	12.02	11.22	10.36
■S-14050		72"	.125	15	72	13.93	13.13	12.33	11.68	11.26
S-11337	6"	24"	.125	10	18	7.48	7.26	7.00	6.55	6.01
S-10691		30"	.125	10	22	8.86	8.52	8.21	7.71	7.06
S-7015		36"	.125	10	29	10.08	9.39	8.81	8.47	8.32
■S-8100		48"	.125	10	42	12.96	12.70	12.44	11.63	10.70
■S-11338		60"	.125	10	42	14.81	14.30	13.50	12.81	12.21
■S-12673	72"	.125	10	45	16.92	16.40	15.59	14.90	14.24	
■S-10692	8"	36"	.125	10	37	17.62	16.89	16.52	16.11	15.42
■S-11339		48"	.125	10	45	18.28	17.45	17.09	16.72	16.05
■S-13748		60"	.125	10	61	22.84	22.04	21.64	21.24	20.57
■S-14051		72"	.125	10	70	24.27	23.42	22.96	22.47	21.66
■S-11340	10"	36"	.125	8	33	23.54	22.62	21.36	20.24	19.70

■ SHIPS VIA MOTOR FREIGHT



Sturdy, oversized tubes protect against tears and creases. Ideal for:

- Auto parts • Construction materials
- Banners and charts • Art prints

**PLASTIC END CAPS INCLUDED**



# ADJUSTABLE TUBES



**HEAVY DUTY**

Thick, strong tubes for heavy-duty shipping jobs.



- Adjustable length – Saves storage space.
- End caps are pre-attached – Tube loads and seals from middle.
- Recommended for industrial parts, metal rods and heavy objects.

MODEL NO.	INSIDE DIAMETER	USABLE LENGTH	THICKNESS	TUBES/CTN.	LBS./CTN.	PRICE EACH (SOLD IN CARTON QTYS.)			
						15-25	100	250	500+
S-11342		24-44"		25	36	\$7.10	\$6.44	\$6.01	\$5.68
■S-11343	3 1/4"	60-120"	.18	15	54	15.67	14.24	13.34	12.51
■S-14054		72-144"		15	65	18.74	17.08	15.75	15.01
■S-12645	4 3/4"	60-120"	.18	15	72	24.66	22.42	20.98	19.71
■S-14055		72-144"		15	86	29.98	27.75	25.70	23.90
■S-21741	6"	60-120"	.18	15	98	35.25	33.16	31.09	29.03
■S-21742		72-144"		15	105	42.30	39.82	37.32	34.83

■ SHIPS VIA MOTOR FREIGHT

# KRAFT TELESCOPIC TUBES



**HEAVY DUTY**

Almost impossible to crush. Safely ship drawings and blueprints.

- 6" flush joint cap seals easily with tape or shipping label.
- 1/8" spiral-wound double walls.
- Attached metal end caps.

MODEL NO.	INSIDE DIAM. x L	THICKNESS	TUBES/CTN.	LBS./CTN.	PRICE EACH (SOLD IN CARTON QTYS.)			
					25	75	125	250+
S-7010	2 x 24"			16	\$3.89	\$3.56	\$3.29	\$2.98
S-1634	2 x 36"	.125	25	22	4.55	4.17	3.85	3.47
S-1635	2 x 43"			24	5.07	4.69	4.33	3.94
S-4198	3 x 25"			21	4.08	3.70	3.43	3.10
S-4199	3 x 31"			26	4.35	3.96	3.65	3.34
S-4202	3 x 37"	.125	25	31	4.87	4.47	4.13	3.77
S-4205	3 x 43"			36	5.56	5.08	4.70	4.23
S-3132	3 x 48"			43	6.92	6.31	5.84	5.25
S-1638	4 x 24"			34	5.92	5.44	5.07	4.59
S-1639	4 x 30"	.125	25	40	6.87	6.31	5.88	5.32
S-1640	4 x 36"			47	7.67	7.04	6.52	5.92
■S-3133	4 x 42"			54	8.20	7.52	6.98	6.35

■ SHIPS VIA MOTOR FREIGHT

# SLICE® TOOLS



**PEN KNIFE**

Cuts through tape, cartons and twine.

- Lightweight ABS plastic handle.

MODEL NO.	PRICE EACH (MIN. 2)			H-3553 EXTRA BLADES
	2	4	6+	
H-5543	\$15	\$14	\$13	\$21 4/pk.



**SCRAPER**

Removes labels, adhesives and rust.

- Sturdy nylon handle with comfort grip.

MODEL NO.	PRICE EACH			H-6667 EXTRA BLADES
	1	3	6+	
H-7945	\$27	\$26	\$25	\$21 3/pk.



**FOLDING UTILITY KNIFE**

Cuts through cartons, vinyl, foam board.

- Durable metal handle w/ finger-loop grip.

MODEL NO.	PRICE EACH			H-6667 EXTRA BLADES
	1	3	6+	
H-7913	\$52	\$51	\$50	\$21 3/pk.

# SNAP-SEAL TUBES

MODEL NO.	INSIDE DIAMETER	INSIDE LENGTH	THICKNESS	TUBES/CTN.	LBS./CTN.	PRICE EACH (SOLD IN CARTON QTYS.)			
						25-70	100	250	500+
S-1616	1½"	9"	.060	70	8	N/A	\$.88	\$.83	\$.77
S-630		12"	.060	70	14	N/A	.91	.86	.81
S-1617		15"	.060	70	15	N/A	1.00	.93	.88
S-631		18"	.060	70	16	N/A	1.01	.97	.93
S-1181		24"	.060	70	18	N/A	1.09	1.03	.97
S-1618		30"	.060	70	23	N/A	1.23	1.20	1.16
S-1182	2"	12"	.060	50	12	\$1.03	.91	.87	.85
S-1619		15"	.060	50	14	1.05	.96	.91	.86
S-632		18"	.060	50	15	1.06	1.00	.96	.87
S-1183		20"	.060	50	16	1.09	1.03	.97	.91
S-633		24"	.060	50	17	1.10	1.05	1.00	.93
S-6215	2" WHITE	24"	.060	50	17	1.34	1.25	1.19	1.13
S-1184	2"	30"	.070	50	21	1.58	1.50	1.40	1.33
S-634		36"	.070	50	23	1.88	1.74	1.65	1.59
S-1620		43"	.070	50	27	2.16	2.00	1.93	1.86
S-2033	2½"	12"	.060	35	9	1.10	1.03	.97	.93
S-2034		15"	.060	35	11	1.13	1.10	1.05	1.00
S-1621		18"	.060	35	14	1.20	1.14	1.11	1.06
S-2035		20"	.070	35	15	1.30	1.25	1.23	1.20
S-1185		24"	.070	35	16	1.50	1.46	1.40	1.36
S-1186		30"	.070	35	21	1.64	1.60	1.56	1.51
S-1187		36"	.070	35	24	1.93	1.86	1.77	1.67
S-2367		3"	12"	.070	25	12	1.50	1.44	1.34
S-1188	15"		.070	25	14	1.51	1.46	1.36	1.28
S-637	18"		.070	25	16	1.59	1.52	1.47	1.38
S-13750	20"		.070	25	17	1.65	1.59	1.51	1.44
S-635	24"		.070	25	18	1.79	1.70	1.61	1.55
S-7009	26"		.070	25	19	1.89	1.83	1.72	1.64
S-1189	30"		.070	25	20	2.00	1.93	1.86	1.77
S-636	36"		.080	25	23	2.34	2.24	2.13	2.02
S-2368	42"		.080	25	24	2.90	2.80	2.70	2.61
S-1622	48"		.080	25	31	3.28	3.17	3.08	2.96
S-1623	4"		12"	.070	25	15	1.99	1.92	1.85
S-1624		18"	.070	25	21	2.35	2.25	2.16	2.06
S-1625		24"	.080	25	25	2.90	2.82	2.73	2.67
S-2635		30"	.080	25	30	3.33	3.21	3.12	3.02
S-2636		36"	.080	25	35	3.77	3.65	3.55	3.45

■ SHIPS VIA MOTOR FREIGHT



A pinch is all you need to seal our most economical tubes!

- Rigid tubes resist folding or bending.
- Easy-to-close ends save time.
- Stays closed – No need for tape.
- Reusable – Easy to open without damaging contents.

### CUSTOM SIZES – SHIPS IN 2-5 DAYS

Available from 1½ to 5" in diameter. Minimum order 250. Call our Quotes Department – 1-888-952-6937.

# LONG POLY MAILERS



Use extra-long mailers to ship wallpaper, parts and fabric.

- Puncture-resistant 4 mil polyethylene. Self-seal closure.
- Water resistant, lightweight and flexible.

MODEL NO.	INSIDE W x L	QTY./CTN.	LBS./CTN.	PRICE PER CARTON		
				1	3	5+
S-14056	6 x 39"	100	6	\$66	\$62	\$59
S-13649	8½ x 33"	100	8	68	64	61
S-10727	8½ x 39"	100	10	74	70	66
S-10728	9½ x 45"	50	7	46	44	41
S-11346	13 x 45"	50	9	63	60	56
S-10729	18 x 48"	25	7	43	41	39
S-14057	18 x 51"	25	8	50	47	44



## SQUARE TUBES

Recommended for storing or mailing documents, maps and blueprints.

- Ships and stores flat – Saves warehouse space.
- Unique **square shape** makes inserting and removing easy.
- Tough 200 lb. test corrugated.
- Locking tabs – No need for tape.

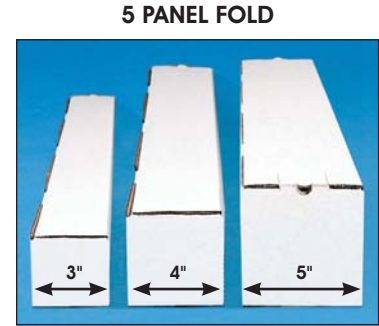

SOLD IN BUNDLE QUANTITIES

\* SPECIFY COLOR: White Kraft

MODEL NO.	INSIDE W x D x L	QTY./ BNDL.	PRICE EACH			LBS./ BNDL.
			50	100	500+	
S-18259	2 x 2 x 25"	50	\$1.17	\$1.01	\$.85	11
S-18260	2 x 2 x 37"		1.52	1.31	1.11	16
S-14937	3 x 3 x 12"	50	1.19	1.04	.87	11
S-3623*	3 x 3 x 18"		1.44	1.19	1.04	15
S-1578*	3 x 3 x 25"		1.84	1.60	1.36	19
S-2966*	3 x 3 x 30"		1.98	1.75	1.52	23
S-1579*	3 x 3 x 37"		2.32	2.08	1.75	26
S-1580	3 x 3 x 43"		2.49	2.32	1.92	30
S-11344*	3 x 3 x 48"		3.12	2.79	2.49	33
S-18261	3 x 3 x 72"		3.33	2.96	2.60	41

SOLD IN BUNDLE QUANTITIES

\* SPECIFY COLOR: White Kraft

MODEL NO.	INSIDE W x D x L	QTY./ BNDL.	PRICE EACH			LBS./ BNDL.
			50	100	500+	
S-18262	4 x 4 x 25"	50	\$2.16	\$1.94	\$1.70	21
S-18263	4 x 4 x 37"		2.64	2.36	2.08	29
S-11345	5 x 5 x 18"	50	2.61	2.32	2.08	23
S-1575*	5 x 5 x 25"		2.79	2.49	2.22	31
S-2967*	5 x 5 x 30"		3.12	2.79	2.49	36
S-1576*	5 x 5 x 37"		3.35	3.02	2.79	44
S-1577*	5 x 5 x 43"		3.90	3.57	3.19	48
S-3624	5 x 5 x 48"		4.55	4.21	3.57	57
■ S-18264	5 x 5 x 72"		5.03	4.55	4.01	65

■ SHIPS VIA MOTOR FREIGHT

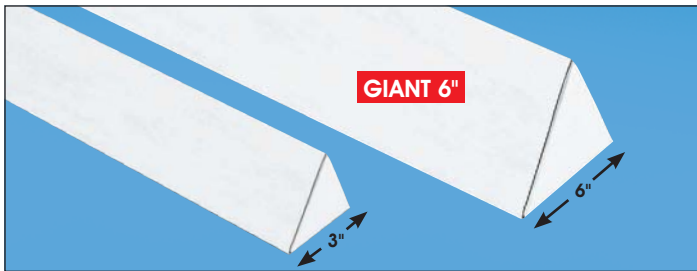

## TRIANGLE TUBES

Unique design. Triangle edges offer extra side protection.

- Sturdy 200 lb. test corrugated.
- Ships and stores flat – Saves warehouse space.

**S-7884 Giant Express** – Tough 250 lb. test with adhesive closure protects posters and documents.

SOLD IN BUNDLE QUANTITIES

MODEL NO.	INSIDE W x L	QTY./ BNDL.	PRICE EACH			LBS./ BNDL.
			50	100	250+	
S-1959	2 x 18 1/4"	50	\$1.17	\$1.08	\$1.04	17
S-1960	2 x 24 1/4"		1.46	1.39	1.31	24
S-1961	2 x 30 1/4"		1.75	1.65	1.60	25
S-1962	2 x 36 1/4"		2.04	1.96	1.88	28

SOLD IN BUNDLE QUANTITIES

MODEL NO.	INSIDE W x L	QTY./ BNDL.	PRICE EACH			LBS./ BNDL.
			50	100	250+	
S-13648	3 x 18 1/4"	50	\$1.88	\$1.81	\$1.70	27
S-8108	3 x 24 1/4"		2.08	1.98	1.91	36
S-8109	3 x 36 1/4"		2.34	2.22	2.11	42
S-7884	6 x 38"		20	5.93	5.65	5.18



## EXTRA PLASTIC END CAPS

\* SPECIFY COLOR: White Black

Reuse your tubes and make custom sizes.

- Secure contents. Won't "pop off" during shipping.

MODEL NO.	DIAM.	QTY./ CARTON	PRICE PER CARTON
S-1364*	1 1/2"	100	\$13
S-1365*	2"		17
S-1366	2 1/2"		21
S-1367*	3"		23
S-2362*	4"		32

MODEL NO.	DIAM.	QTY./ CARTON	PRICE PER CARTON
S-7020	5"	100	\$53
S-7021*	6"		81
S-10734	8"		130
S-11366	10"		165



# WHITE TUBES

45 SIZES IN STOCK

MODEL NO.	INSIDE DIAMETER	USABLE LENGTH	THICKNESS	TUBES/CTN.	LBS./CTN.	PRICE EACH (SOLD IN CARTON QTY.)					
						25-50	100	250	500	1,000+	
S-1016	1½"	12"	.060	50	10	\$1.13	\$1.10	\$1.05	\$.93	\$.86	
S-1627		15"	.060	50	11	1.20	1.13	1.10	1.03	.91	
S-1017		18"	.060	50	12	1.24	1.20	1.13	1.09	1.00	
S-356		24"	.060	50	14	1.46	1.34	1.25	1.20	1.12	
S-1628		30"	.060	50	17	1.64	1.58	1.50	1.39	1.27	
S-2972		36"	.070	50	20	1.88	1.79	1.67	1.60	1.50	
S-22955		48"	.060	50	26	2.52	2.37	2.23	2.09	1.97	
S-3621	2"	6"	.060	50	8	1.05	1.00	.88	.85	.76	
S-3047		9"	.060	50	9	1.14	1.10	1.00	.91	.83	
S-1018		12"	.060	50	14	1.24	1.20	1.05	.97	.87	
S-1629		15"	.060	50	15	1.25	1.21	1.10	1.05	.93	
S-357		18"	.060	50	16	1.30	1.24	1.14	1.11	1.05	
S-1019		20"	.060	50	18	1.40	1.27	1.20	1.13	1.09	
S-358		24"	.060	50	19	1.52	1.40	1.30	1.23	1.16	
S-1024		30"	.070	50	23	1.81	1.67	1.61	1.52	1.43	
S-359		36"	.070	50	26	2.08	1.96	1.85	1.71	1.61	
S-1630		43"	.080	50	37	2.63	2.52	2.37	2.22	2.06	
S-3060		48"	.080	50	40	2.96	2.79	2.56	2.36	2.22	
S-2036		2½"	12"	.060	35	9	1.47	1.40	1.27	1.20	1.11
S-2037			15"	.060	35	11	1.51	1.44	1.34	1.24	1.14
S-1631	18"		.060	35	15	1.59	1.51	1.47	1.33	1.24	
S-2038	20"		.060	35	18	1.62	1.58	1.50	1.39	1.27	
S-1025	24"		.070	35	20	1.81	1.70	1.61	1.51	1.43	
S-1026	30"		.070	35	22	2.09	1.99	1.89	1.81	1.65	
S-1027	36"		.080	35	24	2.56	2.41	2.33	2.18	2.00	
S-8134	3"	6"	.060	50	11	1.34	1.25	1.20	1.12	1.05	
S-8135		9"	.060	25	11	1.59	1.48	1.30	1.23	1.19	
S-1632		12"	.060	25	12	1.84	1.67	1.48	1.38	1.23	
S-22956		13"	.060	25	12	1.85	1.70	1.51	1.46	1.27	
S-1028		15"	.060	25	13	1.86	1.74	1.55	1.47	1.28	
S-910		18"	.070	25	15	1.92	1.79	1.60	1.51	1.36	
S-911		24"	.070	25	17	2.11	1.93	1.74	1.64	1.50	
S-912		30"	.080	25	20	2.52	2.37	2.18	2.00	1.97	
S-913		36"	.080	25	22	2.87	2.72	2.48	2.32	2.24	
S-915		42"	.080	25	24	3.33	3.12	2.99	2.80	2.61	
S-1633		48"	.080	25	27	3.67	3.45	3.30	3.09	2.83	
S-2357	4"	12"	.080	25	14	2.36	2.32	2.23	2.08	1.93	
S-2358		18"	.080	25	18	2.98	2.79	2.52	2.32	2.17	
S-2359		24"	.080	25	25	3.40	3.20	2.90	2.70	2.49	
S-2360		30"	.080	25	35	3.82	3.53	3.20	2.99	2.74	
S-2361		36"	.080	25	38	4.17	3.84	3.49	3.28	3.02	
■ S-3622		42"	.080	25	41	4.57	4.39	4.22	4.03	3.85	
■ S-8107		48"	.080	25	42	5.94	5.70	5.49	5.13	4.73	

■ SHIPS VIA MOTOR FREIGHT



Uline stocks the largest selection of tubes in the country.

Make a first-rate impression when sending calendars, posters or documents.

- 3-ply spiral wound.
- Plastic end caps reinforce shape and won't "pop off" during shipping.
- Plastic end caps included. See page 90 for additional caps.



# COLORED TUBES

MODEL NO.	INSIDE DIAMETER	USABLE LENGTH	THICKNESS	TUBES/CTN.	LBS./CARTON	PRICE EACH (SOLD IN CARTON QTY.)			
						50	100	250	500+
S-8101	2"	6"	.060	50	8	\$1.23	\$1.19	\$1.08	\$.97
S-8102		9"				1.43	1.31	1.23	1.14
S-8103		12"				1.48	1.33	1.24	1.16
S-8104		24"				1.99	1.85	1.69	
S-8105	3"	12"	.060	25	10	2.22	2.08	1.95	1.79
S-8106		24"				2.99	2.82	2.59	2.41

Use these eye-catching colors for important mailings.

- 3-ply spiral wound.
- Plastic end caps included.
- Glossy finish.

SPECIFY COLOR:



**CUSTOM SIZES AND COLORS:** Ships from nearest Uline location in 2-5 days. Min. order 250. Call our Quotes Department – 1-888-952-6937.



### ULINE KRAFT PADDED MAILERS

MODEL NO.	OUTSIDE W x L	INSIDE W x L	BAG #	QTY./ CASE	PRICE PER CASE				CASES/ SKID	SKID LOTS
					1	3	5	10+		
S-21308*	6 x 10"	5½ x 8¾"	0	250	\$69	\$66	\$63	\$60	18	\$54
S-21309	7¼ x 12"	7½ x 10¾"	1	100	\$33 per case any quantity				33	29
S-21310	8½ x 12"	8½ x 10¾"	2	100	44	41	39	36	24	32
S-21311	8½ x 14½"	8½ x 13¼"	3	100	48	46	44	40	27	37
S-21312	9½ x 14½"	9½ x 13¼"	4	100	53	48	46	43	21	39
S-21313	10½ x 16"	10½ x 14¾"	5	100	\$56 per case any quantity				18	51
S-21314	12½ x 19"	12½ x 17¾"	6	50	46	44	41	38	24	35
S-21315	14¼ x 20"	14¼ x 18¾"	7	50	56	54	49	45	21	41

Cushioned padding inside wall of every bag protects against damage.

- Easy to use – Top edge is scored for easy sealing.
- Easy to open – Tear-seam tab on larger sizes.
- Self-seal bags – Adhesive strip secures bags instantly.

### ULINE GOLD PADDED MAILERS

MODEL NO.	OUTSIDE W x L	INSIDE W x L	BAG #	QTY./ CASE	PRICE PER CASE				CASES/ SKID	SKID LOTS
					1	3	5	10+		
S-1412*	6 x 10"	5½ x 8¾"	0	250	\$76	\$71	\$69	\$66	18	\$60
S-1413	7¼ x 12"	7½ x 10¾"	1	100	40	39	38	37	33	33
S-1414	8½ x 12"	8½ x 10¾"	2	100	47	45	43	39	24	36
S-1415	8½ x 14½"	8½ x 13¼"	3	100	53	49	47	44	27	40
S-1416	9½ x 14½"	9½ x 13¼"	4	100	56	53	49	46	21	43
S-1417	10½ x 16"	10½ x 14¾"	5	100	63	62	61	60	18	55
S-1418	12½ x 19"	12½ x 17¾"	6	50	49	47	45	41	24	38
S-1419	14¼ x 20"	14¼ x 18¾"	7	50	60	57	54	48	21	45

- Ships via UPS.

\* No tear-seam tab opener.

- Dispose alongside all other paper products in recycle bin. 
- White Padded Mailers – Impress your customers with a clean, professional look.

**SAVE UP TO 25%  
ON SKID QUANTITIES**

### ULINE WHITE PADDED MAILERS

MODEL NO.	OUTSIDE W x L	INSIDE W x L	BAG #	QTY./ CASE	PRICE PER CASE				CASES/ SKID	SKID LOTS
					1	3	5	10+		
S-7529*	6 x 10"	5½ x 8¾"	0	250	\$93	\$90	\$87	\$82	18	\$74
S-7530	7¼ x 12"	7½ x 10¾"	1	100	52	50	48	46	33	42
S-7531	8½ x 12"	8½ x 10¾"	2	100	58	55	51	49	24	44
S-7532	8½ x 14½"	8½ x 13¼"	3	100	61	59	57	52	27	48
S-7533	9½ x 14½"	9½ x 13¼"	4	100	68	66	63	59	21	52
S-7534	10½ x 16"	10½ x 14¾"	5	100	87	83	73	68	18	63
S-7535	12½ x 19"	12½ x 17¾"	6	50	61	58	55	51	24	47
S-7536	14¼ x 20"	14¼ x 18¾"	7	50	73	68	66	61	21	56

### VIDEO MAILER



Additional multimedia packaging, see [uline.com](http://uline.com)

# ULINE SELF-SEAL BUBBLE MAILERS



The best bubble mailers in the business.

- Seamless bottom for maximum strength. Smooth side seams.
- Sturdy 55 lb. kraft paper with 3/16" bubble lining.
- Self-seal bags – Uline guarantees a secure seal every time.
- Impress your customers with white Uline mailers.



**SAVE UP TO 30%  
ON SKID QUANTITIES**

## DVD MAILER

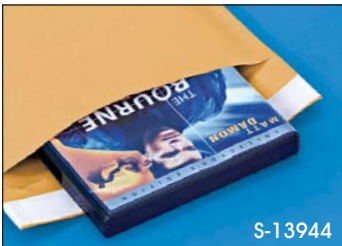

### ULINE GOLD BUBBLE MAILERS

MODEL NO.	OUTSIDE W x L	INSIDE W x L	BAG #	QTY./CASE	PRICE PER CASE				CASES/SKID	SKID LOTS
					1	3	5	10+		
S-9984	4 x 8"	3 $\frac{3}{8}$ x 6 $\frac{3}{4}$ "	000	500	\$84	\$80	\$76	\$70	16	\$65
S-10534	5 x 10"	4 $\frac{7}{8}$ x 8 $\frac{3}{4}$ "	00	250	55	50	47	44	24	39
<b>S-9985</b>	<b>6 x 10"</b>	<b>5<math>\frac{3}{8}</math> x 8<math>\frac{3}{4}</math>"</b>	<b>0</b>	<b>250</b>	<b>\$48 per case any quantity</b>				<b>21</b>	<b>43</b>
S-10535	7 $\frac{1}{4}$ x 8"	7 $\frac{1}{8}$ x 6 $\frac{3}{4}$ "	CD	200	60	58	56	54	24	47
S-13944	7 $\frac{1}{4}$ x 10 $\frac{1}{4}$ "	7 $\frac{1}{8}$ x 9 $\frac{1}{4}$ "	DVD	100	35	33	30	27	40	25
<b>S-9986</b>	<b>7<math>\frac{1}{4}</math> x 12"</b>	<b>7<math>\frac{1}{8}</math> x 10<math>\frac{1}{4}</math>"</b>	<b>1</b>	<b>100</b>	<b>\$27 per case any quantity</b>				<b>36</b>	<b>25</b>
<b>S-9987</b>	<b>8<math>\frac{1}{2}</math> x 12"</b>	<b>8<math>\frac{1}{8}</math> x 10<math>\frac{1}{4}</math>"</b>	<b>2</b>	<b>100</b>	<b>\$32 per case any quantity</b>				<b>36</b>	<b>26</b>
S-10536	8 $\frac{1}{2}$ x 14 $\frac{1}{2}$ "	8 $\frac{3}{8}$ x 13 $\frac{3}{4}$ "	3	100	44	42	39	37	24	34
S-9988	9 $\frac{1}{2}$ x 14 $\frac{1}{2}$ "	9 $\frac{1}{8}$ x 13 $\frac{3}{4}$ "	4	100	48	46	44	42	18	38
<b>S-9989</b>	<b>10<math>\frac{1}{2}</math> x 16"</b>	<b>10<math>\frac{3}{8}</math> x 14<math>\frac{3}{4}</math>"</b>	<b>5</b>	<b>100</b>	<b>\$46 per case any quantity</b>				<b>18</b>	<b>41</b>
S-10537	12 $\frac{1}{2}$ x 19"	12 $\frac{1}{8}$ x 17 $\frac{3}{4}$ "	6	50	42	39	37	35	30	30
S-10538	14 $\frac{1}{4}$ x 20"	14 $\frac{1}{8}$ x 18 $\frac{3}{4}$ "	7	50	46	44	42	39	30	36

### ULINE WHITE BUBBLE MAILERS

MODEL NO.	OUTSIDE W x L	INSIDE W x L	BAG #	QTY./CASE	PRICE PER CASE				CASES/SKID	SKID LOTS
					1	3	5	10+		
S-5631	4 x 8"	3 $\frac{3}{8}$ x 6 $\frac{3}{4}$ "	000	500	\$93	\$88	\$84	\$81	16	\$72
S-5896	5 x 10"	4 $\frac{7}{8}$ x 8 $\frac{3}{4}$ "	00	250	60	56	54	47	24	43
<b>S-5147</b>	<b>6 x 10"</b>	<b>5<math>\frac{3}{8}</math> x 8<math>\frac{3}{4}</math>"</b>	<b>0</b>	<b>250</b>	<b>\$56 per case any quantity</b>				<b>28</b>	<b>49</b>
S-5897	7 $\frac{1}{4}$ x 8"	7 $\frac{1}{8}$ x 6 $\frac{3}{4}$ "	CD	200	68	62	59	55	24	48
S-5632	7 $\frac{1}{4}$ x 12"	7 $\frac{1}{8}$ x 10 $\frac{1}{4}$ "	1	100	39	37	35	33	36	27
S-5148	8 $\frac{1}{2}$ x 12"	8 $\frac{3}{8}$ x 10 $\frac{1}{4}$ "	2	100	43	39	37	35	36	32
S-5898	8 $\frac{1}{2}$ x 14 $\frac{1}{2}$ "	8 $\frac{3}{8}$ x 13 $\frac{3}{4}$ "	3	100	49	46	43	39	24	36
S-5149	9 $\frac{1}{2}$ x 14 $\frac{1}{2}$ "	9 $\frac{1}{8}$ x 13 $\frac{3}{4}$ "	4	100	55	49	45	42	18	38
<b>S-5150</b>	<b>10<math>\frac{1}{2}</math> x 16"</b>	<b>10<math>\frac{3}{8}</math> x 14<math>\frac{3}{4}</math>"</b>	<b>5</b>	<b>100</b>	<b>\$54 per case any quantity</b>				<b>18</b>	<b>47</b>
S-5633	12 $\frac{1}{2}$ x 19"	12 $\frac{1}{8}$ x 17 $\frac{3}{4}$ "	6	50	47	44	42	37	30	34
S-5634	14 $\frac{1}{4}$ x 20"	14 $\frac{1}{8}$ x 18 $\frac{3}{4}$ "	7	50	56	54	47	43	30	39

## IN STOCK – SHIPS TODAY FROM 13 WAREHOUSE LOCATIONS

Chicago • Atlanta • Dallas • Los Angeles • Miami • Minneapolis • NYC/Phila • Reno  
Seattle/Vancouver • Edmonton • Toronto • Mexicali • Monterrey



# ULINE BUBBLE-LINED POLY MAILERS

Water-resistant and tear-proof mailer protects delicate products.

- Extra-smooth surface is perfect for handwriting or labeling.

MODEL NO.	OUTSIDE W x L	USABLE W x L	BAG #	QTY./ CASE	PRICE PER CASE				LBS./ CASE
					1	3	5	10+	
S-8059	4 x 8"	3 $\frac{3}{4}$ x 6 $\frac{3}{4}$ "	000	500	\$93	\$90	\$87	\$84	9
S-8060	5 x 10"	4 $\frac{1}{4}$ x 8 $\frac{3}{4}$ "	00	250	58	56	54	51	7
S-7543	6 x 10"	5 $\frac{1}{2}$ x 8 $\frac{3}{4}$ "	0	250	66	64	62	60	7
S-7544	7 $\frac{1}{4}$ x 12"	7 $\frac{1}{2}$ x 10 $\frac{1}{2}$ "	1	100	35	34	33	32	5
S-7545	8 $\frac{1}{2}$ x 12"	8 $\frac{3}{8}$ x 10 $\frac{3}{4}$ "	2	100	<b>\$36 per case any quantity</b>				5
S-7778	8 $\frac{1}{2}$ x 14 $\frac{1}{2}$ "	8 $\frac{3}{8}$ x 13 $\frac{1}{4}$ "	3	100	42	41	40	39	6
S-7547	9 $\frac{1}{2}$ x 14 $\frac{1}{2}$ "	9 $\frac{3}{8}$ x 13 $\frac{1}{4}$ "	4	100	48	46	44	42	7
S-7548	10 $\frac{1}{2}$ x 16"	10 $\frac{3}{8}$ x 14 $\frac{3}{4}$ "	5	100	59	57	55	53	8
S-7779	12 $\frac{1}{2}$ x 19"	12 $\frac{3}{8}$ x 17 $\frac{3}{4}$ "	6	50	43	42	41	40	6
S-7550	14 $\frac{1}{4}$ x 20"	14 $\frac{1}{8}$ x 18 $\frac{3}{4}$ "	7	50	51	49	47	45	7



SELF-SEAL

- 3/16" bubble lining gently cushions and protects on the inside.

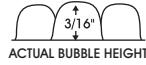

ACTUAL BUBBLE HEIGHT

## GUSSETED

Provides a little extra protection for fine apparel, prepackaged toys or parts.

- 4" bottom gusset to fit bulky items.



SELF-SEAL

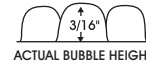

ACTUAL BUBBLE HEIGHT



MODEL NO.	OUTSIDE W x L	USABLE W x L	BAG #	QTY./ CASE	PRICE PER CASE				LBS./ CASE
					1	3	5	10+	
S-24043	10 $\frac{1}{2}$ x 16"	10 $\frac{3}{8}$ x 14 $\frac{3}{4}$ "	5	75	\$69	\$67	\$65	\$63	8
S-24044	14 $\frac{1}{4}$ x 20"	14 $\frac{1}{8}$ x 18 $\frac{3}{4}$ "	7	50	65	63	61	59	9

## EXPANSION POLY MAILERS

Recommended for shipping bulky apparel, purses, books and quilts.

- Water resistant, tear-proof polyethylene.
- 4" bottom gusset.
- High-strength seams allow over-stuffing.
- Perforated tear strip.



SELF-SEAL

Adhesive strip secures bags instantly.

MODEL NO.	OUTSIDE W x L x D	DESCRIPTION	QTY./ CASE	PRICE PER CASE				LBS./ CASE
				1	3	5	10+	
S-17231	10 x 13 x 2"	With Tear Strip	100	\$36	\$35	\$33	\$30	4
S-11481	11 x 13 x 4"			38	37	35	32	5
S-11482	13 x 16 x 4"			50	48	46	42	6
S-13609	15 x 20 x 4"			71	68	65	59	8
S-15895	20 x 24 x 4"			102	98	94	85	13
S-13610	26 x 28 x 5"			144	138	132	120	20
S-15896	30 x 36 x 5"			188	181	173	157	28

## RETURNABLE POLY MAILERS

Used by major online and mail order retailers to ease customer returns.

- Second adhesive strip creates a brand new closure for return shipping.
- Original packaging ensures minimal shipping damage.



DOUBLE SELF-SEAL STRIPS

MODEL NO.	OUTSIDE W x L	DESCRIPTION	QTY./ CASE	PRICE PER CASE					LBS./ CASE
				1	3	5	10	20+	
S-17232	12 x 15 $\frac{1}{2}$ "	With Tear Strip	100	\$39	\$38	\$37	\$36	\$35	5
S-17233	14 x 17"			52	50	48	46	44	6
S-17234	19 x 24"			84	82	80	77	74	12

# ULINE POLY MAILERS

## TEAR-PROOF POLYETHYLENE

MODEL NO.	OUTSIDE W x L	DESCRIPTION	QTY./CASE	PRICE PER CASE					LBS./CASE
				1	3	5	10	20+	
S-3352	6 x 9"	With Tear Strip	100	\$17	\$16	\$15	\$14	\$13	2
S-5617	7½ x 10½"			19	18	17	16	15	2
S-3353	9 x 12"			22	21	20	19	18	3
S-3354	10 x 13"			\$20 per case any quantity					4
S-3355	12 x 15½"			\$27 per case any quantity					5
S-7776	14 x 17"			40	38	36	35	33	6
S-3394	14½ x 19"	Without Tear Strip	100	46	44	42	40	38	7
S-3401	19 x 24"			68	66	63	60	57	12
S-5899	24 x 24"			90	86	83	79	75	16
S-17228	24 x 36"			170	163	156	149	142	20



Lightweight mailers for big postal savings.

## BULK PACKS – Save big with bulk packs.

MODEL NO.	OUTSIDE W x L	DESCRIPTION	QTY./CASE	PRICE PER CASE					LBS./CASE
				1	3	5	10	20+	
S-17229	6 x 9"	With Tear Strip	1,000	\$130	\$127	\$124	\$121	\$118	14
S-20785	7½ x 10½"		1,000	145	142	139	136	133	21
S-13608	9 x 12"		1,000	175	171	167	163	159	28
S-12908	10 x 13"		1,000	194	189	185	180	176	34
S-12909	12 x 15½"		500	128	125	122	119	116	24
S-17230	14 x 17"		500	157	154	150	147	143	30
S-21873	14½ x 19"		500	184	180	175	171	167	33
S-21874	19 x 24"		250	149	143	140	137	134	26
S-21875	24 x 24"		200	167	163	159	155	151	36
S-21876	24 x 36"		200	230	226	222	218	210	41
S-21877	9 x 12"	Without Tear Strip	1,000	175	171	167	163	159	28
S-21878	10 x 13"		1,000	194	189	185	180	176	34
S-21879	12 x 15½"		500	128	125	122	119	116	24
S-12910	14½ x 19"		500	184	180	175	171	167	33

Tough, tear-proof polyethylene envelopes.

- Lightweight, saves on shipping.
- Ink, stamps and labels adhere easily.
- Water resistant.
- Perforated tear strip for easy opening.
- Tamper resistant.

## BULK PACKS



SAVE UP TO 35%

## COLORED POLY MAILERS

Your product will be opened immediately.

- Tough, tear-proof high gloss polyethylene envelopes.
- Lightweight, saves on postage.
- Ink, stamps and labels adhere easily.
- Water resistant.
- Tamper resistant.

SPECIFY COLOR: Blue, Yellow, Red, Black or Pink

MODEL NO.	OUTSIDE W x L	DESCRIPTION	QTY./CASE	PRICE PER CASE					LBS./CASE
				1	3	5	10	20+	
S-21880	10 x 13"	With Tear Strip	100	\$28	\$27	\$26	\$25	\$24	4
S-11483	12 x 15½"			38	37	35	34	32	5
S-11484	14½ x 19"	Without Tear Strip	100	56	54	52	49	47	7



S-21880 and S-11483 – Perforated tear strip for easy opening.

# ULINE ECONOMY BUBBLE MAILERS

  
Actual Bubble  
Height - 1/8"



Featherlight with tough 1/8" bubble for greater postal savings.

- For shipping T-shirts, gloves and non-fragile items.
- Self-seal adhesive strip. No need for tape or staples.

Save up to 20% with  
Economy Mailers

**GOLD** – The old standard. Attractive 52 lb. paper exterior.

MODEL NO.	OUTSIDE W x L	USABLE W x L	BAG #	QTY./ CASE	PRICE PER CASE				LBS./ CASE
					1	3	5	10+	
S-22454	6 x 10"	5 $\frac{7}{8}$ x 8 $\frac{3}{4}$ "	0	250	\$44	\$42	\$39	\$37	9
S-22455	7 $\frac{1}{4}$ x 12"	7 $\frac{1}{8}$ x 10 $\frac{3}{4}$ "	1	100	24	23	22	21	5
S-22456	8 $\frac{1}{2}$ x 12"	8 $\frac{3}{8}$ x 10 $\frac{3}{4}$ "	2	100	26	25	24	23	5
S-23021	9 $\frac{1}{2}$ x 14 $\frac{1}{2}$ "	9 $\frac{3}{8}$ x 13 $\frac{3}{4}$ "	4	100	41	38	36	34	8
S-22457	10 $\frac{1}{2}$ x 16"	10 $\frac{3}{8}$ x 14 $\frac{3}{4}$ "	5	100	42	39	37	35	8
S-23022	14 $\frac{1}{4}$ x 20"	14 $\frac{1}{8}$ x 18 $\frac{3}{4}$ "	7	50	39	37	35	33	8



**WHITE POLY** – Weatherproof and tear resistant. Protects contents.

MODEL NO.	OUTSIDE W x L	USABLE W x L	BAG #	QTY./ CASE	PRICE PER CASE				LBS./ CASE
					1	3	5	10+	
S-22392	6 x 10"	5 $\frac{7}{8}$ x 8 $\frac{3}{4}$ "	0	250	\$54	\$51	\$49	\$46	7
S-22393	7 $\frac{1}{4}$ x 12"	7 $\frac{1}{8}$ x 10 $\frac{3}{4}$ "	1	100	29	28	27	26	5
S-22394	8 $\frac{1}{2}$ x 12"	8 $\frac{3}{8}$ x 10 $\frac{3}{4}$ "	2	100	32	30	29	28	5
S-22946	9 $\frac{1}{2}$ x 14 $\frac{1}{2}$ "	9 $\frac{3}{8}$ x 13 $\frac{3}{4}$ "	4	100	41	39	37	35	7
S-22395	10 $\frac{1}{2}$ x 16"	10 $\frac{3}{8}$ x 14 $\frac{3}{4}$ "	5	100	48	46	44	42	8
S-22947	14 $\frac{1}{4}$ x 20"	14 $\frac{1}{8}$ x 18 $\frac{3}{4}$ "	7	50	43	41	39	37	7

# ULINE ECONOMY COLORED POLY BUBBLE MAILERS



Subtle, handsome and bold. Matte finish.

High-Shine, Metallic Glamour  
Bubble Mailers, see page 103

- Water-resistant and tear-proof.
- 3/16" bubble lining gently cushions and protects.
- Self-seal adhesive strip.

SPECIFY COLOR: Black, Red, Blue, Pink, Teal, Navy or Purple

MODEL NO.	OUTSIDE W x L	USABLE W x L	BAG #	QTY./ CASE	PRICE PER CASE				LBS./ CASE
					1	3	5	10+	
S-22402	6 x 10"	5 $\frac{7}{8}$ x 8 $\frac{3}{4}$ "	0	250	\$78	\$76	\$74	\$70	7
S-22943	7 $\frac{1}{4}$ x 12"	7 $\frac{1}{8}$ x 10 $\frac{3}{4}$ "	1	100	43	41	39	37	5
S-22403	8 $\frac{1}{2}$ x 12"	8 $\frac{3}{8}$ x 10 $\frac{3}{4}$ "	2	100	45	44	43	41	5
S-22944	9 $\frac{1}{2}$ x 14 $\frac{1}{2}$ "	9 $\frac{3}{8}$ x 13 $\frac{3}{4}$ "	4	100	59	57	55	53	7
S-22404	10 $\frac{1}{2}$ x 16"	10 $\frac{3}{8}$ x 14 $\frac{3}{4}$ "	5	100	70	67	65	62	8
S-22945	14 $\frac{1}{4}$ x 20"	14 $\frac{1}{8}$ x 18 $\frac{3}{4}$ "	7	50	60	58	56	54	7

# PRESENTATION FOLDERS

High-gloss folders make a great first impression.

- Recommended for sales presentations and conferences.
- Dual pocket with single die-cut business card slot.
- Laminated cover stock resists smudges and stains.



SPECIFY COLOR: Dark Blue, Red, Green, Black or White

MODEL NO.	DESCRIPTION	SIZE	DIMENSIONS	QTY./ CASE	PRICE PER CASE			LBS./ CASE
					1	5	10+	
S-23023	High Gloss	Letter	11 $\frac{1}{8}$ x 9 $\frac{1}{4}$ "	25	\$53	\$51	\$48	3



# CLEAR PLASTIC TUBES

## TUBES

MODEL NO.	INSIDE W x L	QTY./ CTN.	PRICE EACH (SOLD IN CARTON QTYS.)		
			25	75	125+
S-23600	1/2 x 4"	25	\$.50	\$.45	\$.40
S-14119	1/2 x 8"		.70	.65	.60
S-21972	3/4 x 6"	25	.65	.60	.55
S-11361	3/4 x 8"		.75	.70	.65
S-13749	3/4 x 12"		1.15	1.10	1.00
S-12642	1 1/2 x 6"	25	.75	.70	.65
S-3490	1 1/2 x 8 3/4"		.80	.75	.70
S-7016	1 1/2 x 12"		1.25	1.20	1.10
S-14120	2 x 6"	25	1.25	1.20	1.10
S-6216	2 x 10"		1.45	1.35	1.25
S-3491	2 x 12"		1.75	1.65	1.50
S-10733	2 x 18"		2.65	2.45	2.30
S-3492	2 x 24"		3.20	3.00	2.80
S-12643	3 x 6"		1.45	1.35	1.25
S-7017	3 x 12"	25	2.45	2.30	2.15
S-12644	3 x 18"		3.70	3.40	3.20
S-11362	3 x 36"		6.95	6.50	6.10
S-14121	3 x 48"		9.80	9.20	8.60

Mail or store parts, brochures and invitations.

- Crystal clear tubes let your mailing materials shine through.
- Vinyl end caps fit securely.
- USPS and UPS approved.
- End caps sold separately.



S-14119 MINI-TUBE

## CAPS

SPECIFY COLOR: Red Black Blue Green White Clear

MODEL NO. / COLOR										DIAMETER	QTY./ CARTON	PRICE EACH	
S-14122	Red	S-14123	Black	S-14124	Blue	S-14125	Green	S-14126	White				S-15010
S-11363	Red	S-11364	Black	S-11365	Blue	S-14127	Green	S-14128	White	S-15011	Clear	.21	
S-6224	Red	S-6225	Black	S-10736	Blue	S-14129	Green	S-14130	White	S-15012	Clear	.32	
S-6217	Red	S-6218	Black	S-10737	Blue	S-14131	Green	S-14132	White	S-15013	Clear	.42	
S-7018	Red	S-7019	Black	S-10738	Blue	S-14133	Green	S-14134	White	S-15014	Clear	.63	

LARGER QUANTITIES, CALL FOR QUOTE

## DESKTOP ACCESSORIES

Keep desktops clean, clear and clutter free. Black wire mesh.



PAPER TRAY



ORGANIZER



FILE SORTER

SOLD IN CARTON QUANTITIES

MODEL NO.	DESCRIPTION	SIZE W x L x H	QTY./ CTN.	PRICE EACH		
				2	4-6	12+
H-8811	Paper Tray	17 x 11 x 3"	6	N/A	\$12	\$11
H-8810	Organizer	9 x 5 x 4"	4	N/A	15	13
H-8809	File Sorter	11 x 8 x 10"	2	\$25	23	21

## ORGANIZER CART

Keep supplies organized and mobile at reception desks, offices and schools.

- Black wire mesh drawers glide smoothly and keep contents visible.
- Sturdy steel construction.
- 3" polyurethane swivel casters, 2 locking.

EASY ASSEMBLY. SHIPS VIA UPS.

MODEL NO.	SIZE L x W x H	OVERALL CAPACITY	PRICE EACH	
			1	3+
H-9274	16 x 13 x 37"	200 lbs.	\$100	\$95



6 DRAWERS

## ULINE PALLET NOTES

Convenient sticky notes loaded on a miniature pallet.

- Super sticky.

### FREE OFFER

Free upon request with any Uline order of \$250 or more.



MODEL NO.	COLOR	SIZE	SHEETS/PAD	PRICE EACH
S-14864	Yellow	3 x 3"	500	\$10

## 3M POST-IT® NOTES

Used in almost every business and home for 40 years.

- For lists, planning, sharing and reminders.

Assorted – Includes 6 colors.



MODEL NO.	COLOR	SIZE	SHEETS/PAD	PADS/PACK	PRICE/PACK (MIN. 2)	
					2	3+
S-17271	Yellow	3 x 3"	100	12	\$19	\$18
S-17272	Assorted	3 x 3"	100	12	20	19



**STAYFLATS®**

**SELF-SEAL STAYFLATS®**

**SIDE-LOADING STAYFLATS®**

Industrial strength with economical kraft savings.

- **Heavy board** keeps items flat during shipping.
- Tab lock for mailing or shipping.

**KRAFT STAYFLATS®**

MODEL NO.	OUTSIDE DIMENSIONS		RECOMMENDED USE	QTY./ CASE	PRICE PER CASE					LBS./ CASE
					1	2	5	10	20+	
S-3467	6 x 6"	(9)	CD/DVD w/o Case	200	\$55	\$50	\$46	\$43	\$40	16
S-2219	6 x 8"	(1)	5 x 7" Photos	100	32	30	28	25	23	11
S-5062	7 x 9"	(10)	DVD	100	41	39	36	33	31	10
S-2356	9 x 11½"	(2)	8 x 10" Photos	100	50	47	44	41	38	22
S-2220	9¾ x 12¼"	(5)	Letters/Photos	100	53	49	46	43	40	25
S-2221	11 x 13½"	(3)	Large Documents	100	59	56	53	48	44	30
S-1421	11 x 16"	(8)	Photos/Calendars	100	69	65	61	56	52	34
S-2859	12¾ x 15"	(4)	Legal Size	100	70	66	62	57	53	38
S-2222	13 x 18"	(6)	Art Boards	100	81	76	71	67	63	46
S-904	17 x 21"	(7)	Posters	50	57	54	51	48	45	36
S-1422	18 x 24"	(11)	Posters/Prints	50	89	84	79	73	68	42
S-1423	20 x 27"	(12)	Desktop Calendars	50	114	111	108	105	102	51
S-3465	22 x 27"	(13)	Bulletin Boards	50	127	123	118	114	110	57

Convenient pull-tab tear strip.

- Heavy board protects against crushing.

**Black Stayflats®, see page 100.**

**KRAFT SELF-SEAL STAYFLATS®**

MODEL NO.	OUTSIDE DIMENSIONS		RECOMMENDED USE	QTY./ CASE	PRICE PER CASE					LBS./ CASE
					1	2	5	10	20+	
S-5464	6 x 6"	(9)	CD/DVD w/o Case	200	\$64	\$58	\$55	\$50	\$48	13
S-5613	6 x 8"	(1)	5 x 7" Photos	100	39	38	35	32	30	9
S-5614	7 x 9"	(10)	DVD	100	46	44	41	38	35	11
S-5615	9 x 11½"	(2)	8 x 10" Photos	100	58	56	53	48	45	17
S-5465	9¾ x 12¼"	(5)	Letters/Photos	100	60	58	55	50	46	19
S-5466	11 x 13½"	(3)	Large Documents	100	67	64	60	57	53	24
S-5616	12¾ x 15"	(4)	Legal Size	100	77	73	69	65	60	30
S-5467	13 x 18"	(6)	Art Boards	100	100	95	90	89	87	35
S-6692	17 x 21"	(7)	Posters	100	137	131	125	124	123	56
S-7813	18 x 24"	(11)	Posters/Prints	50	104	100	96	93	91	34
S-7814	20 x 27"	(12)	Desktop Calendars	50	112	109	105	103	101	39

Your products slip quickly into side loaders.

**WHITE SIDE-LOADING STAYFLATS®**

MODEL NO.	OUTSIDE DIMENSIONS		RECOMMENDED USE	QTY./ CASE	PRICE PER CASE					LBS./ CASE
					1	2	5	10	20+	
S-2664	9 x 6"	(B)	5 x 7" Photos	200	\$115	\$110	\$104	\$100	\$95	20
S-3828	12¼ x 9¾"	(S)	Letters/Photos	100	89	84	79	77	74	23



**PRIORITY MAILER**

**SELF-SEAL WITH TEAR STRIP**

Uline's version of the FedEx®-style envelope.

- For prompt delivery of your letters.
- Ships UPS or FedEx®.

MODEL NO.	SIZE	QTY./ CASE	PRICE PER CASE			LBS./ CASE
			1	2	5+	
S-7537	12½ x 9½"	200	\$99	\$95	\$88	22



STAYFLATS®

SELF-SEAL STAYFLATS®

GUSSETED SELF-SEAL STAYFLATS®

### WHITE STAYFLATS®

MODEL NO.	OUTSIDE DIMENSIONS	RECOMMENDED USE	QTY./CASE	PRICE PER CASE					LBS./CASE
				1	2	5	10	20+	
S-1110	6 x 6" (9)	CD/DVD w/o Case	200	\$57	\$53	\$48	\$45	\$42	11
S-1111	6 x 8" (1)	5 x 7" Photos	100	34	32	30	27	25	10
S-1420	7 x 9" (10)	DVD	100	43	41	38	35	33	12
S-901	9 x 11½" (2)	8 x 10" Photos	100	53	49	46	43	40	19
S-902	9¾ x 12¼" (5)	Letters/Photos	100	55	52	48	45	42	23
S-903	11 x 13½" (3)	Large Documents	100	61	58	55	50	46	28
S-1198	12¾ x 15" (4)	Legal Size	100	73	69	65	60	56	34
S-1199	13 x 18" (6)	Art Boards	100	84	79	74	70	66	42
S-2860	17 x 21" (7)	Posters	100	117	110	103	97	91	58
S-3476	18 x 24" (11)	Posters/Prints	50	92	88	82	76	71	38
S-3477	20 x 27" (12)	Desktop Calendars	50	118	115	112	109	106	46
S-5060	22 x 27" (13)	Bulletin Boards	50	131	127	123	118	114	50

First class presentation guaranteed.

- No tape or stiffeners needed. Will not bend or crush.
- Self-locking flap secures shipments.



### WHITE SELF-SEAL STAYFLATS®

MODEL NO.	OUTSIDE DIMENSIONS	RECOMMENDED USE	QTY./CASE	PRICE PER CASE					LBS./CASE
				1	2	5	10	20+	
S-2663	5½ x 5½" (A)	CD w/o Case	200	\$64	\$58	\$55	\$50	\$48	10
S-2212	6 x 6" (9)	CD/DVD w/o Case	200	66	60	57	53	50	11
S-2213	6 x 8" (1)	5 x 7" Photos	100	40	39	36	33	31	10
S-2214	7 x 9" (10)	DVD	100	48	46	43	40	37	12
S-2215	9 x 11½" (2)	8 x 10" Photos	100	60	58	55	50	47	19
S-2665	9¾ x 12¼" (5)	Letters/Photos	100	\$49 per case any quantity					22
S-2666	11 x 13½" (3)	Large Documents	100	69	66	62	59	55	28
S-2667	12¾ x 15" (4)	Legal Size	100	\$65 per case any quantity					34
S-3479	13 x 18" (6)	Art Boards	100	103	98	93	92	90	43
S-3480	17 x 21" (7)	Posters	100	142	136	130	129	128	64
S-5061	18 x 24" (11)	Posters/Prints	50	108	104	100	97	95	38
S-10527	20 x 27" (12)	Desktop Calendars	50	128	125	121	118	116	44
S-10528	22 x 27" (13)	Bulletin Boards	50	147	143	140	137	135	51

Self-seal has peel-off adhesive strip.

- Postage savings due to light weight.
- Convenient pull-tab tear strip.



### GUSSETED SELF-SEAL STAYFLATS®

MODEL NO.	SIZE L x W x H	RECOMMENDED USE	QTY./CASE	PRICE PER CASE			LBS./CASE
				1	2	5+	
S-5894	10 x 7¼ x 1"	CD/DVD	100	\$76	\$72	\$68	14
S-5895	12½ x 9½ x 1"	Books	100	83	78	74	22
S-10554	15 x 12½ x 1"	Spiral Bound Materials	100	94	89	83	30
S-10213	17 x 14 x 1"	Large Documents	100	105	100	95	44

Ship more items in these 1" expandable StayFlats®.

- Recommended for bulky catalogs or files.



## JIFFY RIGI BAG® MAILERS

Finally – A mailer that won't bend, crease or fold!

- Insert material and fold over **self-sealing** flap. No tape or stiffeners needed.
- **Stiff fiberboard** and sturdy kraft construction provide rigid protection.
- Tear strip opening.

MODEL NO.	OUTSIDE DIMENSIONS	RECOMMENDED USE	QTY./CASE	PRICE PER CASE				LBS./CASE
				1	2	5	10+	
S-916	7¼ x 10½" (1)	CD	250	\$108	\$104	\$102	\$99	36
S-1611	8½ x 10½" (2)	8 x 10" Photos	250	127	121	119	116	40
S-917	8½ x 13" (3)	Letters/Books	200	116	111	107	105	41
S-918	9½ x 13" (4)	Photos	200	126	120	118	114	45
S-919	10½ x 14" (5)	Legal Size	150	116	111	108	106	40
S-914	12½ x 15" (6)	Calendars	100	110	105	103	100	34
S-6832	14¼ x 18½" (7)	Posters	75	111	106	104	102	33

SELF-SEAL

## E-Z OPEN MAILERS

WITH TEAR STRIP

Impress potential clients and customers.

- **Tear strip** mailer provides easy, quick opening.
- Self-seal closure. • Heavy-duty 26 pt. board.

MODEL NO.	OUTSIDE DIMENSIONS	RECOMMENDED USE	QTY./CASE	PRICE PER CASE				LBS./CASE
				1	2	5	10+	
S-6181	6 x 8"	5 x 7" Photos	100	\$48	\$46	\$42	\$39	9
S-6182	7 x 9"	DVD		62	59	55	49	12
S-6183	9 x 11½"	8 x 10" Photos		71	69	64	59	19
S-6184	9¾ x 12¼"	Letters/Photos		78	74	69	64	21
S-6185	11 x 13½"	Large Documents		83	78	71	66	27
S-6186	12½ x 15"	Legal Size		96	90	80	77	34

TEAR STRIP

SELF-SEAL

## BLACK STAYFLATS®

Complete Line of StayFlats®, pages 98-99.

Heavy-duty black StayFlats® protect your valuable photos and documents.

- Peel-and-seal closure with easy-open tear strip.
- No tape or stiffeners needed. Will not bend or crush.

MODEL NO.	OUTSIDE DIMENSIONS	RECOMMENDED USE	QTY./CASE	PRICE PER CASE					LBS./CASE
				1	2	5	10	20+	
S-11837	9¾ x 12¼" (5)	Letters/Photos	100	\$87	\$81	\$76	\$70	\$65	22
S-11838	11 x 13½" (3)	Large Documents		97	91	84	78	73	27
S-11839	13 x 18" (6)	Documents/Art Boards		136	128	119	110	102	42
S-13629	17 x 21" (7)	Posters		230	216	202	187	173	64

SELF-SEAL

## CLEAR VIEW MAILERS

Instant exposure for your catalogs and promotional mailing pieces.

- Clear poly front allows for easy viewing of contents.
- White poly backing for labeling and postage.

MODEL NO.	OUTSIDE W x L	USABLE W x L	THICK-NESS	QTY./PACK	PRICE PER PACK					LBS./PACK
					1	3	5	10	20+	
S-17250	5 x 7"	5 x 7"	3 mil	100	\$19	\$18	\$17	\$16	\$15	1
S-12822	6 x 9"	6 x 9"			20	19	18	17	16	2
S-7780	9 x 12"	9 x 12"			25	24	23	21	20	3
S-7781	10 x 13"	10 x 13"			28	26	25	23	22	4
S-14540	12 x 15½"	12 x 15½"			38	36	34	32	30	5
S-7782	14 x 17"	14 x 17"			45	43	41	38	36	6
S-17251	14½ x 19"	14½ x 19"			64	61	57	54	51	7

SELF-SEAL

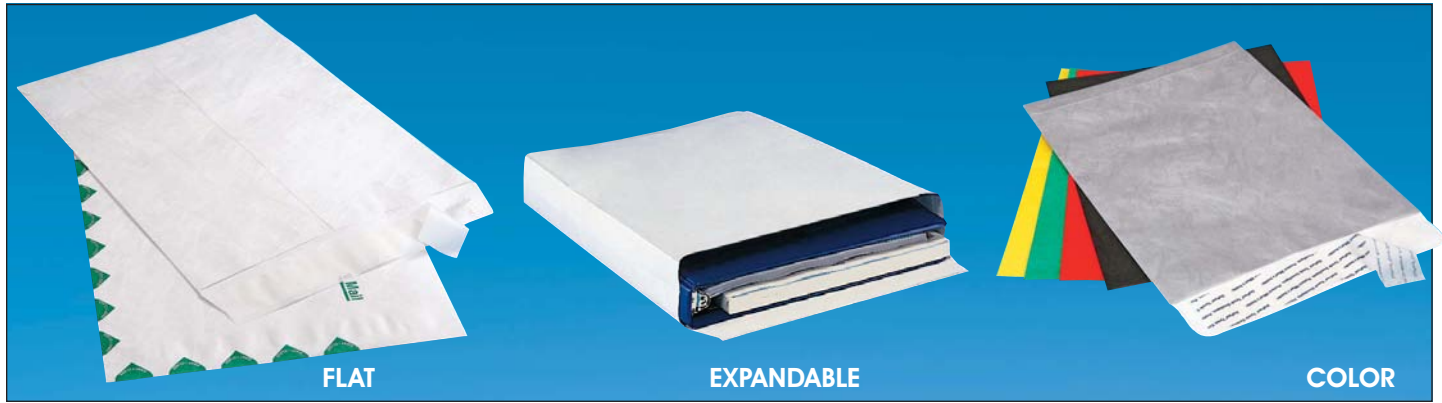

Resist tearing, puncturing and water damage with these **self-seal** mailers.

**FLAT** – Recommended for important documents and sensitive materials.

- Virtually indestructible – Tyvek® material is ten times stronger than paper.
- Save postage – Half the weight of paper.
- 14 lb. spunbound olefin.

**EXPANDABLE** – Ship bulky catalogs, reports or paperwork.

- Ship twice as much in one envelope.
- Large opening for quick and easy packing.
- Tough, 18 lb. tear-resistant olefin.

**COLOR** – Stand out from the clutter and create a powerful first impression.

- Additional colors available on request – 5,000 piece minimum.

### FLAT

MODEL NO.	OUTSIDE W x L	DESCRIPTION	QTY./CASE	PRICE PER CASE					LBS./CASE
				1	3	5	10	20+	
S-5618	6 x 9"	White	100	\$37	\$33	\$31	\$30	\$29	2
S-5900	7½ x 10½"			44	41	39	38	37	2
S-5151	9 x 12"			47	45	43	41	40	3
S-5152	9 x 12"	First Class	100	49	46	44	43	41	3
S-12798	9½ x 12½"	White		52	48	46	45	44	3
S-5153	10 x 13"	White		\$45 per case any quantity					3
S-6365	10 x 13"	First Class		54	52	49	48	47	3
S-5154	10 x 15"	White	100	63	59	56	55	54	4
S-5155	12 x 15½"			\$63 per case any quantity					4
S-6849	13 x 19"			135	126	120	115	112	6
S-11492	15 x 20"			189	179	170	164	160	8
S-11493	18 x 23"			228	220	210	204	199	10

### EXPANDABLE

MODEL NO.	OUTSIDE W x L x D	DESC.	OPENING	QTY./CASE	PRICE PER CASE					LBS./CASE	
					1	3	5	10	20+		
S-5901	9 x 12 x 2"	White	End	100	\$98	\$95	\$93	\$91	\$90	5	
S-5619	10 x 13 x 1½"				99	97	94	92	91	5	
S-6851	10 x 13 x 2"				115	112	107	105	102	5	
S-5620	12 x 16 x 2"				\$125 per case any quantity					6	
S-5621	10 x 13 x 2"	White	Side	100	115	113	110	107	106	5	
S-6853	10 x 15 x 2"				121	118	116	115	113	6	
S-5622	12 x 16 x 4"				50	112	109	106	103	101	5

### COLOR

MODEL NO.	OUTSIDE W x L	SPECIFY COLOR	QTY./CASE	PRICE PER CASE			LBS./CASE
				1	3	5+	
S-11494	9 x 12"	Yellow, Green, Red, Black or Silver	100	\$117	\$115	\$112	3
S-10771	10 x 13"			123	121	117	4
S-10772	12 x 15½"			154	147	139	5

# SHIP-lite® ENVELOPES

# ECONOMY

Save money with these economical mailers.

- Six times stronger than paper.
- Moisture resistant.

MODEL NO.	OUTSIDE W x L x D	DESCRIPTION	QTY./CASE	PRICE PER CASE					LBS./CASE
				1	3	5	10	20+	
S-6366	9 x 12"	Flat	100	\$52	\$50	\$49	\$47	\$46	4
S-6367	10 x 13"			60	59	58	56	54	5
S-6368	12 x 15½"			83	82	81	79	77	7
S-6369	10 x 13 x 1½"	Expandable	100	107	105	103	101	99	7
S-6370	12 x 16 x 2"			162	160	158	155	151	10



## FULL-VIEW WINDOW ENVELOPES

Window lets you see what's inside. Display company name and literature while protecting contents.

- Recommended for catalogs, brochures and direct mailings.
- Moisten gummed flap to seal.



S-17154 –  
Get your mail  
piece opened.



28 LB. SPECIFY COLOR:  White  Red  Blue  Yellow

MODEL NO.	OUTSIDE W x L	WINDOW DIMENSIONS	QTY./ CASE	PRICE PER CASE			LBS./ CASE
				1	3	5+	
S-6291	4 1/8 x 9 1/2"	2 5/8 x 7 1/2"	500	\$78	\$74	\$71	7
S-6292	6 x 9"	4 x 7 1/8"		108	104	100	8
S-6293	8 3/4 x 11 1/2"	7 x 9 3/4"		160	152	145	16
S-6294	9 x 12"	7 x 9 3/4"		162	155	147	17
S-6295	10 x 13"	7 7/8 x 9 3/4"		204	197	189	22

28 LB. BLACK

MODEL NO.	OUTSIDE W x L	WINDOW DIMENSIONS	QTY./ CASE	PRICE PER CASE			LBS./ CASE
				1	3	5+	
S-17154	6 x 9"	4 x 7 7/8"	100	\$89	\$85	\$81	2
S-17155	9 x 12"	7 x 9 3/4"		147	140	133	4

## PRESENTATION ENVELOPES

Organize and protect important documents and presentations.

- Extremely durable polypropylene.
- Water and tear resistant.
- 1 1/4" expandable gusset.



SPECIFY COLOR: Clear, Red, Black or Blue

MODEL NO.	CLOSURE STYLE	SIZE	DIMENSIONS	QTY./ CASE	PRICE PER CASE			LBS./ CASE
					1	2	5+	
S-12766	String/Button	Letter	11 x 9"	24	\$41	\$39	\$36	2
S-12767		Legal	14 x 9"		45	43	40	
S-14541	Velcro®	Letter	11 x 9"	24	46	44	41	2
S-14542		Legal	14 x 9"		50	48	45	

## GLASSINE ENVELOPES

Glassine envelopes preserve and protect your valuable photos and negatives.

- Acid Free – Will prevent deterioration in storage.



MODEL NO.	OUTSIDE DIMENSIONS	RECOMMENDED USE	QTY./ CTN.	PRICE PER CARTON			LBS./ CTN.
				1	3	5+	
S-11834	2 3/4 x 3 3/4"	Wallet Size Photos	1,000	\$88	\$82	\$77	2
S-11835	4 1/8 x 6 1/4"	4 x 6" Photos	1,000	152	143	133	4
S-11836	9 1/2 x 11"	8 x 10" Photos	500	265	249	234	9

## RIGID PLASTIC BOXES

Package, display or organize small items.

- Clear packaging helps products look their best.
- Hinged on back.

100% POLYSTYRENE

\* 2-piece box

MODEL NO.	DIMENSIONS L x W x H	BASE DEPTH	LID HEIGHT	QTY./ CTN.	PRICE PER CARTON		
					1	2	5+
S-6277	3 5/8 x 2 5/8 x 1 1/8"	7/8"	1/4"	175	\$130	\$125	\$120
S-9805*	3 3/4 x 3 3/4 x 3 3/4"	3 3/4"	1/4"	25	61	57	55
S-6278	4 5/8 x 3 1/2 x 1 1/4"	5/8"	5/8"	84	100	95	90
S-6279	6 x 4 x 2"	1"	1"	75	135	130	125
S-6280	7 x 5 x 1 3/4"	7/8"	7/8"	45	120	115	110

S-6278



S-6280

S-9805





# ULINE GLAMOUR BUBBLE MAILERS



SPECIFY COLOR: Silver, Purple, Orange, Red, Gold, Green, Pink, Blue or Black

MODEL NO.	OUTSIDE W x L	USABLE W x L	RECOMMENDED USE	QTY./ CASE	PRICE PER CASE	
					1	5+
S-22954	5 x 8 1/4"	4 x 8"	Cosmetics	250	\$121	\$111
S-7786	7 x 6 3/4"	6 x 6 1/2"	CD	72	77	72
S-11504*	7 1/2 x 11"	6 1/2 x 10 1/2"	Jewelry	72	82	77
S-14660*	9 x 11 1/2"	8 x 11"	Small Books	100	118	110
S-7787*	11 x 13 3/4"	10 1/2 x 12 3/4"	Letters/Photos	48	\$87 per case any qty.	
S-11505	13 x 17 1/2"	12 x 17"	Apparel	100	139	129
S-17158	16 x 17 1/2"	15 x 17"	Calendars	48	102	95
S-17159	19 x 22 1/2"	18 x 22"	Posters/Prints	48	146	136

\* Also available in White

Your customers will open this mailer. Style and protection all in one.

- Flashy metallic on the outside.
- Protective 3/16" bubble on the inside.
- Self-seal closure.
- S-7787 – Long-side opening.
- Larger quantities – Call for quote.

## MATTE GLAMOUR BUBBLE MAILERS

Add a level of subtle sophistication for cosmetic launches and fashion releases.

- Trendy matte finish.
- Moisture, tear and puncture resistant.
- Protective 3/16" bubble on the inside.
- Self-seal closure.
- S-23392 – Long-side opening.

SPECIFY COLOR: Black, Red, Rose Gold, Silver, Green, Blue or Gold

MODEL NO.	OUTSIDE W x L	USABLE W x L	RECOMMENDED USE	QTY./ CTN.	PRICE PER CARTON	
					1	5+
S-23390	7 1/2 x 11"	6 1/2 x 10 1/2"	Jewelry	72	\$82	\$77
S-23391	9 x 11 1/2"	8 x 11"	Small Books	100	118	110
S-23392	11 x 13 3/4"	10 1/2 x 12 3/4"	Letters/Photos	48	95	87
S-25076*	13 x 17 1/2"	12 x 17"	Apparel	100	139	129

\* Available in Rose Gold, Blue and Black



## GLAMOUR MAILERS

Dramatically increase your mailing piece response rate.

- Metalized envelopes have self-seal closure with lip.
- Durable, waterproof 2.8 mil.
- Choose from 5 stock sizes.

SPECIFY COLOR

MODEL NO.	OUTSIDE W x L	USABLE W x L	COLORS	QTY./ CTN.	PRICE PER CARTON	
					1	5+
S-10014	6 3/4 x 8"	6 x 8"	Metallic	250	\$85	\$80
S-7102	6 1/4 x 10 1/4"	6 1/4 x 9 1/2"	Black, Purple, Red,		86	81
S-7783	9 1/2 x 12 3/4"	9 1/2 x 12"	Blue, Gold, Silver or Green		140	130
S-10015	10 1/4 x 13"	10 x 13"			170	160



# CLASP ENVELOPES

Reusable metal clasp. Moisten gummed flap for a permanent seal.



KRAFT			28 LB. KRAFT				LBS./CASE
MODEL NO.	OUTSIDE W x L	QTY./CASE	PRICE PER CASE				
			1	3	5	10+	
S-12916	5 x 7½"	250	\$60	\$58	\$56	\$54	5
S-7791	6 x 9"	100	15	14	13	12	2
S-5624	6½ x 9½"		17	16	15	14	3
S-6282	7½ x 10½"		20	19	18	17	4
S-5625	9 x 12"		\$17 per case any quantity				5
S-7792	9½ x 12½"		22	21	20	19	5
S-5626	10 x 13"		23	22	21	20	5
S-5876	10 x 15"		26	25	24	23	6
S-6283	11½ x 14½"		31	30	29	28	7
S-5877	12 x 15½"		35	34	33	32	7

# GUMMED ENVELOPES

Seal contents securely with heavily gummed flap.



KRAFT			28 LB. KRAFT				LBS./CASE
MODEL NO.	OUTSIDE W x L	QTY./CASE	PRICE PER CASE				
			1	3	5	10+	
S-7793	6 x 9"	500	\$49	\$48	\$47	\$46	10
S-12794	6½ x 9½"		69	68	67	65	15
S-7794	7½ x 10½"		84	83	81	79	14
S-7795	9 x 12"	250	\$36 per case any quantity				10
S-12795	9½ x 12½"		52	51	50	48	13
S-7796	10 x 13"		49	48	47	46	12
S-14597	11½ x 14½"		59	58	57	56	15
S-7797	12 x 15½"		66	65	64	62	16



WHITE			28 LB. WHITE				LBS./CASE
MODEL NO.	OUTSIDE W x L	QTY./CASE	PRICE PER CASE				
			1	3	5	10+	
S-7864*	6 x 9"	500	\$46	\$45	\$44	\$43	9
S-12796*	6½ x 9½"		62	61	60	58	15
S-12797	7½ x 10½"		78	77	75	73	20
S-7865	9 x 12"	250	37	36	35	34	10
S-7866	10 x 13"		47	46	45	43	12

\* 24 LB. WHITE

BOOKLET – Wide side opening.			28 LB. KRAFT OR WHITE				LBS./ROLL
MODEL NO.	DESCRIPTION	QTY./ROLL	PRICE PER ROLL				
			1	3	6+		
S-12870*	9 x 6" White	100	\$13	\$12	\$11	\$10	2
S-7800	12 x 9" Kraft		19	18	17	16	5
S-7799	12 x 9" White		18	17	16	15	5
S-13647	13 x 10" White		20	19	18	17	6

\* 24 LB. WHITE

# SEAL AND SHIP ROLL

Send packages without boxes, filler or tape.

- Water and tear resistant bubble sticks to itself, not your product.



Position product.



Wrap and press to seal.



MODEL NO.	DESCRIPTION	ROLL SIZE W x L	PRICE PER ROLL			LBS./ROLL
			1	3	6+	
S-23829	Seal and Ship Roll	16" x 250'	\$95	\$90	\$85	12

# REDI-SEAL ENVELOPES

Create a professional presentation with a premium catalog envelope.

## KRAFT

28 LB. KRAFT

MODEL NO.	OUTSIDE W x L	QTY./ CASE	PRICE PER CASE				LBS./ CASE
			1	3	5	10+	
S-6818	6 x 9"	100	\$15	\$14	\$13	\$12	3
S-7803	6½ x 9½"		16	15	14	13	3
S-12799	7½ x 10½"		21	20	19	18	4
S-7804	9½ x 12½"		20	19	18	17	5
S-6821	12 x 15½"		35	34	33	32	7

## BULK PACKS

28 LB. KRAFT

MODEL NO.	OUTSIDE W x L	QTY./ CASE	PRICE PER CASE				LBS./ CASE
			1	3	5	10+	
S-10376	9 x 12"	500	\$67	\$65	\$63	\$61	19
S-10378	10 x 13"		74	72	70	68	23

## WHITE

28 LB. WHITE

MODEL NO.	OUTSIDE W x L	QTY./ CASE	PRICE PER CASE				LBS./ CASE
			1	3	5	10+	
S-6287	6 x 9"	100	\$17	\$16	\$15	\$14	3



- Convenient self-seal. Requires no moisture. Just close flap and press to seal.

# SELF-SEAL ENVELOPES

## REGULAR

28 LB. KRAFT OR WHITE

MODEL NO.	OUTSIDE W x L	COLOR	PRICE PER CASE OF 100				LBS./ CASE
			1	3	5	10+	
S-12802	6 x 9"	Kraft	\$19	\$18	\$17	\$16	3
S-13684	6½ x 9½"		21	20	19	18	3
S-7805	9 x 12"		21	20	19	18	5
S-13685	9½ x 12½"		24	23	22	21	5
S-7806	10 x 13"		23	22	21	20	5
S-13686	12 x 15½"		39	38	37	36	8
S-12803	6 x 9"	White	18	17	16	15	3
S-13687	6½ x 9½"		20	19	18	17	3
S-7807	9 x 12"		\$17 per case any quantity				5
S-13688	9½ x 12½"		22	21	20	19	5
S-7808	10 x 13"		21	20	19	18	5
S-13689	12 x 15½"		38	37	36	35	8



Extra-strong adhesive keeps documents secure.

## BULK PACKS

28 LB. KRAFT OR WHITE

MODEL NO.	OUTSIDE W x L	COLOR	PRICE PER CASE OF 500				LBS./ CASE
			1	3	5	10+	
S-24696	6 x 9"	Kraft	\$62	\$59	\$57	\$54	11
S-11887	9 x 12"		73	70	68	65	20
S-11888	10 x 13"		80	78	75	72	24
S-24697	6 x 9"	White	59	56	54	51	11
S-11889	9 x 12"		\$60 per case any quantity				20
S-11890	10 x 13"		\$65 per case any quantity				24

- Peel off paper strip and press for a permanent seal.
- Expansion envelopes open up to 2" deep for bulkier mailings.

## EXPANSION

40 LB. KRAFT

MODEL NO.	OUTSIDE W x L x H	OPENING	PRICE PER CASE OF 100				LBS./ CASE
			1	3	5	10+	
S-24807	5 x 11 x 2"	End	\$64	\$62	\$60	\$58	6
S-24808	10 x 13 x 2"		84	82	80	78	10
S-24809	9 x 12 x 2"	Side	73	71	69	67	10
S-24810	10 x 15 x 2"		81	79	77	75	12
S-24811	12 x 16 x 2"		102	100	98	96	14





# COIN ENVELOPES

## KRAFT

24 LB. KRAFT

MODEL NO.	OUTSIDE W x L	QTY./CASE	PRICE PER CASE OF 500				LBS./CASE
			1	3	5	10+	
S-7798	2¼ x 3½"	500	\$20	\$19	\$18	\$17	2
S-6285	2½ x 4¼"		21	20	19	18	2
S-14719	3 x 4½"		25	24	23	22	3
S-6286	3½ x 5½"		25	24	23	22	4
S-14720	3¾ x 6"		29	28	27	26	4
S-5623	3½ x 6½"		29	28	27	26	5

## WHITE

24 LB. WHITE

S-11485	2¼ x 3½"	500	\$21	\$20	\$19	\$18	2
S-12775	2½ x 4¼"		22	21	20	19	2
S-17208	3 x 4½"		26	25	24	23	3
S-11486	3½ x 5½"		26	25	24	23	3
S-17209	3¾ x 6"		30	29	28	27	4
S-11487	3½ x 6½"		30	29	28	27	5

## COLORED

24 LB. COLORED

S-23028*	2¼ x 3½"	500	\$63	\$62	\$60	\$58	2
----------	----------	-----	------	------	------	------	---



Small envelopes hold coins, small parts, keys and jewelry.

- Extra-deep gummed flap.
- Wide seam construction.

\* **S-23028** – Fits standard size gift cards. Available in Red, Lime and Black.



# JUMBO ENVELOPES

## KRAFT

28 LB. KRAFT

MODEL NO.	OUTSIDE W x L	QTY./CASE	PRICE PER CASE OF 100				LBS./CASE
			1	3	5	10+	
S-5276	12½ x 18½"	100	\$49	\$48	\$47	\$46	9
S-5277	14 x 18"		54	53	52	51	10
S-5278	15 x 20"		60	58	55	53	11
S-6281	16 x 20"		62	59	56	54	12
S-5279	17 x 22"		68	65	62	59	14
S-5280	18 x 23"		77	74	71	67	16
S-5872	22 x 27"		105	100	96	91	22
S-14718*	24 x 30"		205	200	195	190	29
S-12774*	24 x 36"		220	215	210	205	39

\* 32 LB. KRAFT

## WHITE

28 LB. WHITE

S-17206	12½ x 18½"	100	\$53	\$52	\$51	\$50	9
S-17207	17 x 22"		75	72	68	65	13
S-11491	22 x 27"		120	115	110	105	21



Mail and store oversized artwork, blueprints, maps or drawings.

- No folding or rolling up necessary.
- Ungummed flaps.

# SELF-SEAL BUSINESS ENVELOPES

Save time and effort with convenient self-seal closure.

- Peel off adhesive paper strip and press for a permanent seal.

24 LB. WHITE

MODEL NO.	SIZE W x L	DESCRIPTION	LINER	QTY./BOX	PRICE PER BOX		
					1	3	5+
S-21899	3¾ x 8"	#8½ Double Window	Security Tint	250	\$32	\$31	\$30
S-17268	3¾ x 8"	#9 Plain	Security Tint	250	21	20	19
S-17269	3¾ x 8"	#9 Double Window			30	29	28
S-11503	4¾ x 9½"	#10 Plain	Security Tint	500	30	29	28
S-14622	4¾ x 9½"	#10 Left Window			39	38	37
S-14623	4¾ x 9½"	#10 Double Window			42	41	40



# BUSINESS ENVELOPES

**GUMMED**

## MACHINABLE/INSERTABLE

MODEL NO.	SIZE W x L	DESCRIPTION	LINER	QTY./ BOX	24 LB. WHITE PRICE PER BOX		
					1	3	5+
S-21890	3 5/8 x 8 5/8"	#8 5/8 Plain			\$39	\$38	\$37
S-21891	3 7/8 x 8 5/8"	#9 Right Window			40	39	38
S-21892	4 1/8 x 9 1/2"	#10 Plain	Security Tint	500	30	29	28
S-21893	4 1/8 x 9 1/2"	#10 Left Window			33	32	30
S-11502	4 1/8 x 9 1/2"	#10 Double Window			<b>\$32 per box any qty.</b>		
S-21894*	4 1/8 x 9 1/2"	#10 Plain – Specify Color	Plain	500	83	79	76
S-19527	4 1/2 x 10 3/8"	#11 Plain	Security Tint		44	43	42

\* Available in Red, Green or Yellow

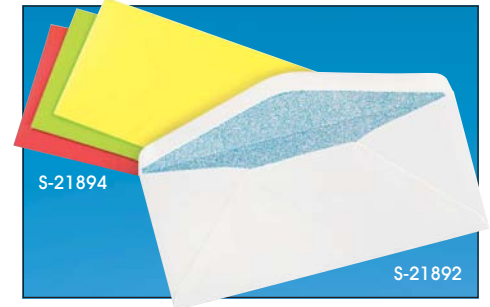

#10 is the most popular size for letters and invoices.

**Machinable Envelopes** – For large volume mailings. Narrow flap compatible with automatic insertion equipment.

## V-FLAP

MODEL NO.	SIZE W x L	DESCRIPTION	LINER	QTY./ BOX	24 LB. WHITE PRICE PER BOX		
					1	3	5+
S-21896	3 3/8 x 6 1/2"	#6 1/2 Plain	Security Tint	500	\$31	\$30	\$29
S-19526	3 5/8 x 8 5/8"	#8 5/8 Double Window			36	35	34
S-13707	3 3/8 x 8 5/8"	#9 Plain	Plain	500	23	22	21
S-17266	3 3/8 x 8 5/8"	#9 Left Window	Security Tint	500	26	25	24
S-16147	3 3/8 x 8 5/8"	#9 Double Window			39	38	37
S-7801	4 1/8 x 9 1/2"	#10 Plain	Plain	500	24	23	22
S-7802	4 1/8 x 9 1/2"	#10 Left Window			27	26	25
S-17267	4 1/8 x 9 1/2"	#10 Right Window	Security Tint	500	34	33	32



**V-Flap Envelopes** – A traditional, professional look.

**Laser Printable Envelope** – Designed to withstand heat of laser printers.

## LASER PRINTABLE

MODEL NO.	SIZE W x L	DESCRIPTION	LINER	QTY./ BOX	24 LB. WHITE PRICE PER BOX		
					1	3	5+
S-21303	4 1/8 x 9 1/2"	#10 Left Window	Security Tint	500	\$38	\$36	\$34

## ACCOUNTING SOFTWARE

MODEL NO.	SIZE W x L	DESCRIPTION	LINER	QTY./ BOX	24 LB. WHITE PRICE PER BOX		
					1	3	5+
S-21897	3 3/8 x 8 5/8"	#9 Double Window	Security Tint	500	\$49	\$47	\$45
S-21898	4 1/8 x 9 1/2"	#10 Double Window					

**Accounting Software Envelopes** – Windows positioned for pre-formatted documents. QuickBooks® compatible.

# AUTOMATIC LETTER OPENER

Make quick work of a tiresome job.

- Portable, handheld unit.

**FREE OFFER**  
Order \$150 of business envelopes and receive a free Letter Opener.

MODEL NO.	DESCRIPTION	PRICE EACH		
		1	3	6+
H-2869	Automatic	\$24	\$23	\$22

Requires 4 AA batteries, see page 636

- Auto-activation when envelope is inserted.
- Home or office use.



# SLICE® BOX CUTTERS

Knife like no other. Circular handle with soft rubber grip.

- Standard – Retractable with 3 blade positions.
- Safety – Auto-retractable blade.



MODEL NO.	DESCRIPTION	PRICE EACH			H-3553 EXTRA BLADES	Ceramic blade lasts 10 times longer than steel.
		1	3	6+		
H-3551	Standard	\$21	\$20	\$19	\$21 4/pk.	
H-3552	Safety	23	22	21		





# ANNOUNCEMENT ENVELOPES

Invite guests to casual get-togethers or black tie events with ultra-white envelopes.

- Gummed envelopes compatible with automated insertion equipment.
- Additional envelopes, see [uline.com](http://uline.com)

## GUMMED 24 LB. WHITE

MODEL NO.	SIZE W x L	NO.	QTY./ BOX	PRICE PER BOX		
				1	3	5+
S-17263	3 5/8 x 5 1/2"	A1	500	\$41	\$39	\$36
S-12804	4 3/8 x 5 3/4"	A2		44	42	39
S-17264	4 1/4 x 6 1/4"	A4		45	43	40
S-12805	4 3/4 x 6 1/2"	A6		47	45	42
S-12806	5 1/4 x 7 1/4"	A7		49	46	43
S-14593	5 1/2 x 8 1/8"	A8		58	55	52
S-13645	5 3/4 x 8 3/4"	A9		65	62	59
S-17265	6 x 9 1/2"	A10		72	69	66

## GUMMED (CONTINUED) 28 LB. WHITE

MODEL NO.	SIZE W x L	NO.	QTY./ BOX	PRICE PER BOX		
				1	3	5+
S-14621	9 x 9"	Square	500	\$94	\$90	\$86

## SELF-SEAL 24 LB. WHITE

MODEL NO.	SIZE W x L	NO.	QTY./ BOX	PRICE PER BOX		
				1	3	5+
S-20834	4 3/8 x 5 1/4"	A2	500	\$65	\$62	\$59
S-20835	4 1/4 x 6 1/4"	A4		80	77	74
S-20836	4 3/4 x 6 1/2"	A6		75	72	69
S-20837	5 1/4 x 7 1/4"	A7		76	73	70
S-20838	5 3/4 x 8 3/4"	A9		86	83	80



## FILE FOLDERS

Keep your work organized.

- Expands up to 3/4". 11-point stock.
- Assorted Packs** – Include 20 each of Red, Blue, Yellow, Bright Green and Orange.

\* SPECIFY COLOR: Red, Blue, Yellow, Bright Green or Orange

MODEL NO.	SIZE	COLOR	TABS	QTY./ BOX	PRICE/BOX (MIN. 2)		
					2	5	10+
S-19528	Letter	Manila	3	100	\$17	\$16	\$15
S-20839*		Specify			29	28	27
S-19529		Assorted			38	36	34
S-20840	Legal	Manila	3	100	20	19	18
S-20841		Assorted			39	38	37

## HANGING FOLDERS

An office filing essential.

- Hanging Folder tabs and inserts included.

**Assorted Packs** – Include 5 each of Red, Blue, Yellow, Bright Green and Orange.



MODEL NO.	SIZE	COLOR	TABS	QTY./ BOX	PRICE/BOX (MIN. 2)		
					2	5	10+
S-19530	Letter	Green	5	25	\$20	\$19	\$18
S-25107		Blue			25	24	23
S-19531		Assorted			24	23	22
S-20842	Legal	Green	5	25	24	23	22
S-20843		Assorted			30	29	28



## POLY FILE FOLDERS

Tough, strong and quickly identifiable.

- Reusable. Adhesive labels remove easily.
- Wear, tear and moisture resistant.

**Assorted Poly Pack** – 6 each of Red, Yellow, Blue and Green.



**Frosted Project Pocket** – Provide a clear view of your paperwork.

### LETTER SIZE

MODEL NO.	DESCRIPTION	COLOR	TABS	QTY./ BOX	PRICE/BOX (MIN. 2)		
					2	5	10+
S-21936	Poly Pack	Assorted	3	24	\$27	\$26	\$25
S-21937	Project Pocket	Frosted	N/A	10	N/A	9	8

## EXPANDING FILE FOLDERS

Used by sales reps, accountants and lawyers to carry paperwork.

**Accordion Files** – Sort paperwork alphabetically. Protective flap with elastic cord closure. 21 pockets.

**File Pocket** – 3 1/2" expansion accommodates multiple files. Heavy duty with Tyvek®-reinforced sides.



### LETTER SIZE

MODEL NO.	DESCRIPTION	QTY./ BOX	PRICE PER BOX		
			1	5	10+
S-21938	Brown A-Z Accordion File	1	\$22	\$21	\$20
S-21939	Brown File Pocket	25	54	52	50



# RUBBER BANDS

## 1 LB. DISPENSER BOX

\* SPECIFY COLOR: Tan, Red or Black

MODEL NO.	SIZE L x W	SIZE #	QTY./ BOX	MODEL NO.	SIZE L x W	SIZE #	QTY./ BOX	PRICE PER BOX		
								2	6	10+
S-17254	Assorted	54	320	S-6188*	3 x 1/8"	32	700	\$6.49	\$6.25	\$6.00
S-14721	7/8 x 1/16"	8	5,200	S-17257	3 x 1/4"	63	380	6.49	6.25	6.00
S-12776	1 1/4 x 1/16"	10	3,700	S-17258	3 x 3/8"	73	240	6.49	6.25	6.00
S-14722	1 1/4 x 1/8"	27	1,800	S-6187	3 1/2 x 1/16"	19	1,250	6.49	6.25	6.00
S-12777	1 1/4 x 1/16"	12	2,500	S-11489*	3 1/2 x 1/8"	33	600	6.49	6.25	6.00
S-17255	1 1/4 x 1/4"	57	650	S-6189*	3 1/2 x 1/4"	64	320	6.49	6.25	6.00
S-14723	2 x 1/16"	14	2,250	S-17259	3 1/2 x 3/8"	74	200	6.49	6.25	6.00
S-12778*	2 x 1/8"	30	1,150	S-12780	3 1/2 x 1/2"	84	150	6.49	6.25	6.00
S-12779*	2 1/2 x 1/16"	16	1,800	S-14724	5 x 5/8"	105	60	6.49	6.25	6.00
S-13705	2 1/2 x 1/8"	31	850	S-17261	7 x 1/16"	117A	400	6.49	6.25	6.00
S-13706*	2 1/2 x 1/4"	62	450	S-11490*	7 x 1/8"	117B	200	6.49	6.25	6.00
S-11488	3 x 1/16"	18	1,480	S-12781*	7 x 5/8"	107	40	6.49	6.25	6.00



- Convenient 1 lb. dispenser boxes.

**S-17254** – Combines postal approved (#64) with most popular office sizes (#19 and #33).

## 5 LB. BULK BAGS

• Postal approved band

MODEL NO.	SIZE L x W	SIZE #	QTY./ BAG	MODEL NO.	SIZE L x W	SIZE #	QTY./ BAG	PRICE PER BAG		
								2	6	10+
S-21960	2 x 1/8"	30	5,750	S-17262	3 1/2 x 1/8"	33	3,000	\$29	\$28	\$27
S-20821	2 1/2 x 1/16"	16	9,000	S-15806•	3 1/2 x 1/4"	64	2,125			
S-17339	3 x 1/8"	32	3,500	S-21961	3 1/2 x 1/2"	84	750			
S-19400	3 1/2 x 1/16"	19	6,250	S-20822	7 x 1/8"	117B	900			

**5 lb. Bulk Bags** – Save over individual boxes.

**Latex Free** – Protects against allergic reactions. 3-5% of the world's population is affected by latex allergies.

## LATEX FREE

MODEL NO.	SIZE L x W	SIZE #	QTY./ BOX	MODEL NO.	SIZE L x W	SIZE #	QTY./ BOX	PRICE PER BOX		
								2	6	10+
S-21962	Assorted	54	380	S-15809	3 1/2 x 1/8"	33	720	\$10.35	\$9.95	\$9.60
S-15807	3 x 1/8"	32	830	S-15810	3 1/2 x 1/4"	64	380			
S-15808	3 1/2 x 1/16"	19	1,440	S-20967	7 x 1/8"	117B	250			



# BLANK ID CARDS

Provide identification for new employees, students and club members.

- Durable plastic with smooth, glossy surface.
- Printable on both sides.

MODEL NO.	DESCRIPTION	CARD SIZE W x H	MIL	QTY./ BOX	PRICE PER BOX	
					1	2+
S-23095	Uline	3.38 x 2.12"	30	500	\$80	\$79
S-23096	Zebra				90	89

- Works with all common badge printers.



# ZEBRA ID CARD PRINTER

Improve security. Issue photo IDs for accessing gyms, schools and office buildings.

- Sharp, edge-to-edge graphics. Prints up to 140 dual-sided color cards per hour.
- USB and Ethernet connectivity.
- Easy-to-use software with design templates.

Accessories and more information, see [uline.com](http://uline.com)

**2 YEAR WARRANTY**

MODEL NO.	PRINTER TYPE	PRINT QUALITY	PRINT SPEED	MAX. PRINT W x H	PRICE EACH
H-7990	ZC300	300 dpi	25 sec./card	3.38 x 2.12"	\$2,600

Drop ships in 3 to 5 days from KY

- Includes 200 plastic cards, color ribbon, web camera, software and power supply.



ZC300

# BADGE HOLDERS



DELUXE



HANGING STYLE



ARMBAND

S-14781

S-14782



CLIP-ON



COLOR CODED



PRE-PUNCHED

S-13758

S-14783

**Deluxe Magnetic** – Reusable magnet works through heavy clothes.

**Clip-on** – Metal bulldog clip won't snag clothing.

**Hanging** – No pins or clips! Elastic cord included.

**Color Coded** – Identify visitors or attendees at a glance.

**Armband** – For physically active employees. Provides safety.

**Pre-punched Sleeve** – Fits lanyards, chains and clips.

**Inserts** – Perforated. Laser/inkjet compatible.

\* Inserts included

▲ SPECIFY COLOR: Yellow, Red or Blue

MODEL NO.	DESCRIPTION	CARD SIZE W x H	QTY./ BOX	PRICE PER BOX		
				1	5	10+
S-20814	Deluxe Magnetic	3 x 2"	50	\$98	\$91	\$83
S-12940		4 x 3"		102	95	88
S-20815	Clip-on	3 x 4"	50	29	28	27
S-10444*		4 x 3"				
S-10445*	Hanging Style	4 x 3"	50	30	29	28
S-17242*▲		4 x 3"		52	50	48
S-14782*	Armband	2 x 3"	12	45	43	40
S-14781		3 x 2"				

\* Inserts included

• SPECIFY COLOR: White or Black

MODEL NO.	DESCRIPTION	CARD SIZE W x H	QTY./ BOX	PRICE PER BOX		
				1	5	10+
S-14783	Pre-punched Sleeve	2 x 3"	100	\$24	\$23	\$22
S-20816		3 x 4"	50	27	26	25
S-13758*		4 x 3"	50	24	23	22
S-21915		4 x 6"	100	50	48	46
S-14784	Paper Inserts	3 x 2"	400	20	19	18
S-10446		4 x 3"	300	20	19	18
S-6745		4 x 6"	100	\$22 any quantity		



Retractable

Breakaway

Standard with 2 Hooks



Standard with Hook

Standard with Clip

Metal Chain

# LANYARDS

**Standard** – Basic lanyard. Round woven nylon with swivel hook or bulldog clip. 38" long.

**Metal Chain** – Beaded nickel steel chain.

**Breakaway** – Breakaway joint snaps apart under stress. Easily snaps back together.

**Retractable** – Clip holds badges for easy access. Cord extends up to 36".

\* SPECIFY COLOR: Black, Blue or Red

MODEL NO.	DESCRIPTION	LENGTH	QTY./ PACK	PRICE PER PACK		
				1	5	10+
S-13755*	Standard w/ Hook	38"	24	\$13	\$11	\$9
S-20219*	Standard w/ Clip	38"	24	17	15	13
S-21916	Standard w/ 2 Hooks	38"	24	31	29	27
S-14785	Metal Chain	30"	50	27	25	23
S-13756*	Breakaway	38"	24	32	30	28
S-13757	Retractable	36"	12	31	29	27

# LAMINATING POUCHES

## GLOSSY

\* Loops included

MODEL NO.	DESCRIPTION	SIZE	MIL	QTY./CTN.	PRICE PER CTN.	
					1	3+
S-10473	Letter Size	9 x 11 1/2"	3	100	<b>\$26 per ctn.</b>	
S-10474	Legal Size	9 x 14 1/2"			\$41	\$36
S-10475	Menu Size	11 1/2 x 17 1/2"			45	42
S-7641	Business Card Size	2 3/16 x 3 1/16"	5	100	10	9
S-7642*	Luggage/I.D. Tag	2 1/2 x 4 1/4"			21	19
S-11150	Index Card Size	3 1/2 x 5 1/2"			12	11
S-19731	Half Letter Size	6 x 9"			25	23
S-7644	Letter Size	9 x 11 1/2"	10	100	<b>\$32 per ctn.</b>	
S-7656	Legal Size	9 x 14 1/2"			49	46
S-7657	Menu Size	11 1/2 x 17 1/2"			70	66
S-16232	Business Card Size	2 3/16 x 3 1/16"	10	100	19	17
S-16233*	Luggage/I.D. Tag	2 1/2 x 4 1/4"			48	44
S-19732	Index Card Size	3 1/2 x 5 1/2"			29	26
S-20797	Half Letter Size	6 x 9"			50	46
S-16234	Letter Size	9 x 11 1/2"	10	100	71	67
S-19733	Legal Size	9 x 14 1/2"			103	98
S-16235	Menu Size	11 1/2 x 17 1/2"			139	130

## MATTE

S-22948	Business Card Size	2 3/16 x 3 1/16"	3	100	\$16	\$14
S-22949	Letter Size	9 x 11 1/2"			62	57
S-22950	Menu Size	11 1/2 x 17 1/2"			104	99
S-22951	Business Card Size	2 3/16 x 3 1/16"	5	100	18	16
S-22952	Letter Size	9 x 11 1/2"			73	68
S-22953	Menu Size	11 1/2 x 17 1/2"			109	104

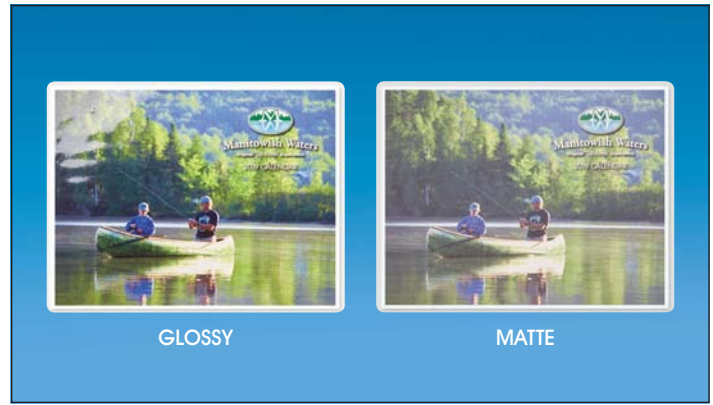

Protect and preserve documents, signs and business cards.

- Oversized so documents slip in easily. Rounded corners.

**Glossy** – Crystal-clear photo quality.

**Matte** – Soft finish, eliminates glare for easy reading.

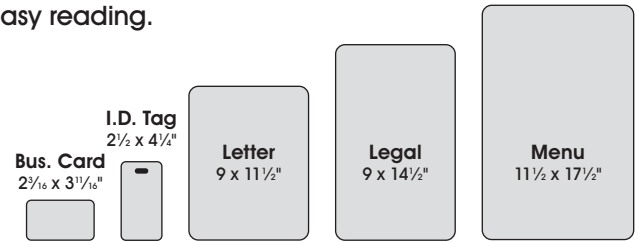

# LAMINATORS

**Office** – For periodic office use. Provides a finished look.

**Industrial** – 3x faster for higher-volume use. A workhorse.

For use with Laminating Pouches only

MODEL NO.	DESCRIPTION	SEALS UP TO	SPEED (PER MIN.)	WIDTH	PRICE EACH	
					1	3+
H-937	Office	5 mil	19"	12"	\$199	\$189
H-1886	Industrial	10 mil	33"	12"	319	309



OFFICE



INDUSTRIAL

# SELF-LAMINATING POUCHES

MODEL NO.	DESCRIPTION	SIZE	MIL	QTY./CTN.	PRICE PER CTN.	
					1	3+
S-10471	Business Card	2 3/8 x 3 7/8"	8	100	\$35	\$29
S-10472	Letter	9 1/16 x 11 1/16"			69	61

Peel and seal – No equipment needed.

- Strong 8 mil thickness.



# LAMINATING ROLLS

MODEL NO.	DESCRIPTION	SIZE W x L	MIL	ROLLS/CTN.	PRICE PER CTN.	
					1	3+
S-20275	School Grade	12" x 500'	1.5	2	\$39	\$36
S-20276		25" x 500'			78	72
S-20277	Standard	12" x 250'	3	2	44	40
S-20278		25" x 250'			82	77
S-20279	Heavy Duty	25" x 200'	5	2	108	104
S-20280		27" x 200'			113	109

Protect and enhance posters, prints and documents.

- Clear gloss finish. Works with most thermal roll laminators.
- 1" core.





# ULINE 2 MIL RECLOSABLE BAGS



The prices are right on these quality reclosable poly bags.

- **Single-track zipper** closure keeps out dirt and moisture.
- All virgin polyethylene film meets FDA and USDA requirements.
- **Adhesive-backed reclosable bags**, see page 757.
- Combine sizes for volume discounts.

**IN STOCK – SHIPS TODAY**

2 MIL							
MODEL NO.	INSIDE W x L	LBS./CTN.	PRICE PER CARTON				QTY./CTN.
			1	5	10	25+	
S-12250	1 x 1"	1	\$15	\$14	\$12	\$11	1,000
S-22671	1 x 3"	1	18	17	15	13	1,000
S-10819	1½ x 1½"	1	16	15	13	12	1,000
S-220	1½ x 2"	1	17	16	14	12	1,000
S-1690	2 x 2"	1	19	18	16	14	1,000
<b>S-1291</b>	<b>2 x 3"</b>	<b>2</b>	<b>\$15 per carton any quantity</b>				<b>1,000</b>
S-12248	2 x 4"	2	24	23	20	17	1,000
S-1897	2 x 5"	2	28	26	23	19	1,000
S-2007	2 x 6"	2	33	27	24	20	1,000
S-22672	2 x 7"	3	35	30	25	22	1,000
S-1691	2 x 8"	3	37	32	27	25	1,000
S-22673	2 x 9"	4	40	35	30	26	1,000
S-12247	2½ x 3"	2	24	23	20	17	1,000
S-17728	2½ x 10"	3	42	40	34	28	1,000
S-2011	2½ x 12"	3	51	49	42	35	1,000
S-17729	3 x 2"	2	23	20	18	16	1,000
S-1692	3 x 3"	3	25	24	21	17	1,000
<b>S-1292</b>	<b>3 x 4"</b>	<b>3</b>	<b>\$18 per carton any quantity</b>				<b>1,000</b>
<b>S-1293</b>	<b>3 x 5"</b>	<b>4</b>	<b>\$20 per carton any quantity</b>				<b>1,000</b>
S-2008	3 x 6"	4	34	30	26	21	1,000
S-17730	3 x 7"	4	37	33	28	23	1,000
S-2827	3 x 8"	5	41	36	30	26	1,000
S-17731	3 x 9"	5	45	39	35	28	1,000
S-2828	3 x 10"	5	47	41	37	29	1,000
S-2829	3 x 12"	6	57	51	45	35	1,000
S-2830	3 x 14"	7	65	59	51	42	1,000
S-2831	4 x 3"	3	27	25	21	18	1,000
S-1693	4 x 4"	4	28	27	25	19	1,000
S-3460	4 x 5"	5	34	30	27	21	1,000
<b>S-1294</b>	<b>4 x 6"</b>	<b>6</b>	<b>\$23 per carton any quantity</b>				<b>1,000</b>
S-1898	4 x 7"	6	39	35	30	26	1,000
S-1694	4 x 8"	7	44	40	34	27	1,000
S-17732	4 x 9"	7	54	49	42	33	1,000

2 MIL							
MODEL NO.	INSIDE W x L	LBS./CTN.	PRICE PER CARTON				QTY./CTN.
			1	5	10	25+	
S-2832	4 x 10"	7	\$67	\$60	\$50	\$39	1,000
S-17733	4 x 12"	8	81	72	61	47	1,000
S-2833	4 x 15"	10	93	81	69	55	1,000
S-22674	4 x 18"	12	100	89	77	62	1,000
S-22675	4 x 20"	14	109	98	86	79	1,000
S-2375	5 x 3"	4	38	33	31	29	1,000
S-1899	5 x 5"	6	39	34	32	30	1,000
S-10820	5 x 6"	7	42	38	33	31	1,000
S-1695	5 x 7"	8	44	40	34	32	1,000
S-1295	5 x 8"	8	47	43	37	33	1,000
S-17734	5 x 9"	9	51	46	41	36	1,000
S-1900	5 x 10"	10	57	51	47	41	1,000
S-1901	5 x 12"	12	66	61	54	46	1,000
S-17735	5 x 15"	14	88	81	70	58	1,000
S-1696	6 x 4"	7	41	38	34	30	1,000
<b>S-1697</b>	<b>6 x 6"</b>	<b>8</b>	<b>\$32 per carton any quantity</b>				<b>1,000</b>
S-22676	6 x 7"	10	50	47	43	37	1,000
S-1698	6 x 8"	11	54	50	46	38	1,000
<b>S-1296</b>	<b>6 x 9"</b>	<b>12</b>	<b>\$38 per carton any quantity</b>				<b>1,000</b>
S-1297	6 x 10"	13	61	57	51	42	1,000
S-22677	6 x 11"	13	65	61	55	46	1,000
S-1902	6 x 12"	14	69	65	58	49	1,000
S-20516	6 x 14"	15	89	81	71	63	1,000
S-2834	6 x 15"	15	93	85	76	66	1,000
S-10821	6 x 20"	21	121	108	97	89	1,000
S-6932	7 x 5"	8	55	51	46	34	1,000
S-17736	7 x 7"	9	59	54	48	38	1,000
S-2835	7 x 8"	10	62	57	49	41	1,000
S-6952	7 x 9"	13	68	63	57	48	1,000
S-2836	7 x 10"	14	76	69	62	54	1,000
S-6953	7 x 12"	16	85	79	69	62	1,000
S-17737	7 x 15"	18	109	99	89	80	1,000
S-6954	8 x 5"	9	60	54	47	38	1,000

# ULINE 2 MIL RECLOSABLE BAGS

Keep items clean and ready to use.

- 100% virgin polyethylene film. FDA and USDA compliant.
- Combine sizes for volume discounts.
- Pricing is right on these quality reclosable poly bags.
- Single-track zipper closure.

**IN STOCK – SHIPS TODAY**



2 MIL							
MODEL NO.	INSIDE W x L	LBS./ CTN.	PRICE PER CARTON				QTY./ CTN.
			1	5	10	25+	
S-1699	8 x 8"	12	\$68	\$63	\$57	\$49	1,000
<b>S-1700</b>	<b>8 x 10"</b>	<b>16</b>	<b>\$51 per carton any quantity</b>				<b>1,000</b>
S-1298	8 x 12"	18	78	72	65	55	1,000
S-22681	8 x 13"	19	86	79	70	61	1,000
S-17738	8 x 18"	23	127	117	105	89	1,000
S-17739	9 x 6"	12	60	56	49	43	1,000
S-13487	9 x 9"	16	74	67	60	54	1,000
S-22682	9 x 10"	17	78	70	63	58	1,000
<b>S-1299</b>	<b>9 x 12"</b>	<b>21</b>	<b>\$54 per carton any quantity</b>				<b>1,000</b>
S-22683	9 x 13"	22	81	71	66	59	1,000
S-6955	9 x 14"	23	86	77	70	63	1,000
S-17740	9 x 15"	25	122	112	99	90	1,000
S-1300	10 x 10"	20	90	82	71	64	1,000
<b>S-1701</b>	<b>10 x 12"</b>	<b>24</b>	<b>\$69 per carton any quantity</b>				<b>1,000</b>
S-1702	10 x 13"	26	106	97	86	76	1,000
S-6956	10 x 14"	29	111	99	91	81	1,000
S-17741	10 x 15"	31	131	118	108	96	1,000
S-17742	10 x 16"	33	133	120	110	97	1,000
S-22684	10 x 18"	38	144	128	118	105	1,000
S-17743	11 x 11"	24	120	110	98	87	1,000
S-22685	11 x 13"	26	123	112	100	90	1,000
S-22686	11 x 14"	30	128	118	106	96	1,000
S-22687	11 x 16"	34	133	124	111	101	1,000
S-17744	12 x 10"	24	103	93	84	74	1,000
S-1703	12 x 12"	28	113	103	95	84	1,000
S-3461	12 x 13"	30	118	109	98	90	1,000
S-6957	12 x 14"	34	120	111	106	96	1,000
<b>S-1301</b>	<b>12 x 15"</b>	<b>38</b>	<b>\$98 per carton any quantity</b>				<b>1,000</b>
S-10822	12 x 16"	39	130	124	116	105	1,000
S-6958	12 x 18"	44	146	137	119	107	1,000
S-17745	12 x 20"	19	125	116	105	91	500
S-22688	12 x 24"	25	143	132	122	108	500
S-17746	13 x 13"	34	129	119	108	95	1,000

2 MIL							
MODEL NO.	INSIDE W x L	LBS./ CTN.	PRICE PER CARTON				QTY./ CTN.
			1	5	10	25+	
S-1704	13 x 15"	37	\$144	\$133	\$118	\$105	1,000
S-6959	13 x 16"	41	155	146	139	126	1,000
S-22689	13 x 17"	43	158	149	143	133	1,000
S-2009	13 x 18"	45	160	153	147	142	1,000
S-17747	13 x 20"	20	134	127	116	97	500
S-12249	14 x 14"	35	148	138	127	117	1,000
S-22690	14 x 15"	38	153	143	133	124	1,000
S-6960	14 x 16"	42	156	147	140	129	1,000
S-13488	14 x 18"	19	128	119	113	106	500
S-2837	14 x 20"	21	141	130	117	111	500
S-13489	14 x 24"	30	162	149	139	128	500
S-17748	15 x 15"	18	123	116	106	92	500
S-17749	15 x 18"	22	140	126	116	108	500
S-20517	15 x 20"	25	155	141	130	123	500
S-22691	15 x 30"	32	169	158	146	134	500
S-17750	16 x 16"	25	138	122	112	105	500
S-10823	16 x 18"	27	155	142	130	125	500
S-13490	16 x 20"	29	160	147	138	128	500
S-17751	16 x 24"	31	180	166	156	143	500
S-2838	18 x 20"	31	166	154	143	129	500
S-10824	18 x 24"	37	186	174	162	149	500
S-12251	20 x 20"	33	169	156	144	130	500
S-12252	20 x 24"	39	205	194	180	166	500
S-17752	20 x 30"	31	146	135	127	117	250
S-22692	21 x 21"	35	175	163	150	138	500
S-22693	22 x 24"	23	130	120	110	102	250
S-12253	24 x 24"	25	138	127	118	109	250
S-17753	24 x 28"	29	151	141	131	120	250
S-17754	24 x 30"	33	159	147	135	126	250
S-12254	24 x 36"	33	172	160	147	135	250
S-17755	26 x 26"	31	151	141	131	120	250
S-17756	26 x 28"	33	159	147	135	126	250
S-17758	30 x 30"	41	205	189	175	161	250

# ULINE 4 MIL RECLOSABLE BAGS

IN STOCK – SHIPS TODAY



## 100 STOCK SIZES

Heavyweight bags provide total protection from oil, dust and moisture.

- All virgin polyethylene film meets FDA and USDA requirements.
- Save 20% over other brand name bags.
- Combine sizes for volume discounts.



### 4 MIL

MODEL NO.	INSIDE W x L	LBS./CTN.	PRICE PER CARTON				QTY./CTN.
			1	5	10	25+	
S-12258	2 x 2"	2	\$33	\$30	\$27	\$21	1,000
<b>S-7006</b>	<b>2 x 3"</b>	<b>4</b>	<b>\$27 per carton any quantity</b>				<b>1,000</b>
S-17759	2 x 4"	4	44	42	37	32	1,000
S-3933	2 x 5"	5	51	49	45	38	1,000
S-17760	2 x 6"	6	55	51	47	42	1,000
S-15246	2 x 8"	8	62	57	51	46	1,000
S-17761	2 x 10"	10	67	63	58	50	1,000
S-1705	2½ x 3"	4	44	42	39	32	1,000
S-2610	3 x 3"	4	46	44	41	33	1,000
S-1706	3 x 4"	5	50	47	45	38	1,000
<b>S-1707</b>	<b>3 x 5"</b>	<b>6</b>	<b>\$39 per carton any quantity</b>				<b>1,000</b>
S-3118	3 x 6"	7	60	56	50	45	1,000
S-13491	3 x 8"	9	66	61	54	49	1,000
S-15247	3 x 10"	12	72	68	63	54	1,000
S-17763	3 x 12"	14	89	83	76	67	1,000
S-1708	4 x 4"	7	58	54	49	43	1,000
S-3803	4 x 5"	8	60	56	50	44	1,000
<b>S-1302</b>	<b>4 x 6"</b>	<b>9</b>	<b>\$46 per carton any quantity</b>				<b>1,000</b>
S-3119	4 x 7"	10	74	66	58	51	1,000
S-1903	4 x 8"	12	83	76	66	58	1,000
S-2014	4 x 9"	13	88	79	69	63	1,000
S-2015	4 x 10"	14	91	83	71	65	1,000
S-10828	4 x 12"	18	100	90	79	70	1,000
S-6961	4 x 15"	22	107	97	84	79	1,000
S-3804	5 x 5"	9	70	66	60	54	1,000
S-12255	5 x 6"	12	71	67	62	54	1,000
S-3120	5 x 7"	14	75	68	64	57	1,000
S-1709	5 x 8"	15	79	74	67	59	1,000
S-20518	5 x 9"	16	87	79	71	62	1,000
S-3121	5 x 10"	18	89	83	74	63	1,000
S-2376	5 x 12"	19	99	91	81	70	1,000
S-15248	5 x 15"	23	140	126	116	105	1,000
S-2016	6 x 4"	12	81	74	64	54	1,000
S-1710	6 x 6"	15	88	80	70	64	1,000
S-1711	6 x 8"	17	93	85	80	68	1,000
<b>S-1712</b>	<b>6 x 9"</b>	<b>19</b>	<b>\$76 per carton any quantity</b>				<b>1,000</b>
S-2611	6 x 10"	21	120	111	98	90	1,000

### 4 MIL

MODEL NO.	INSIDE W x L	LBS./CTN.	PRICE PER CARTON				QTY./CTN.
			1	5	10	25+	
S-2839	6 x 12"	27	\$127	\$116	\$106	\$96	1,000
S-14382	6 x 15"	31	149	138	125	114	1,000
S-17778	6 x 18"	35	161	147	134	124	1,000
S-22678	6 x 20"	40	186	170	158	146	1,000
S-22679	6 x 24"	47	242	219	208	196	1,000
S-22680	6 x 36"	31	186	170	158	146	500
S-17779	7 x 5"	14	77	69	64	58	1,000
S-3805	7 x 8"	23	110	101	93	83	1,000
S-13492	7 x 9"	25	119	112	101	92	1,000
S-3806	7 x 10"	28	129	119	109	98	1,000
S-14383	7 x 12"	30	160	146	134	123	1,000
S-6962	7 x 15"	33	164	149	138	127	1,000
S-1303	8 x 8"	22	122	113	101	93	1,000
<b>S-1713</b>	<b>8 x 10"</b>	<b>28</b>	<b>\$107 per carton any quantity</b>				<b>1,000</b>
S-3122	8 x 12"	31	151	140	127	117	1,000
S-10829	8 x 18"	27	127	117	107	97	500
S-17780	9 x 9"	29	133	124	112	101	1,000
<b>S-1304</b>	<b>9 x 12"</b>	<b>33</b>	<b>\$109 per carton any quantity</b>				<b>1,000</b>
S-20519	9 x 13"	37	139	133	129	118	1,000
S-17781	9 x 14"	41	165	158	148	126	1,000
S-2612	9 x 15"	43	187	176	165	142	1,000
S-2613	10 x 10"	34	161	147	135	124	1,000
<b>S-1904</b>	<b>10 x 12"</b>	<b>40</b>	<b>\$135 per carton any quantity</b>				<b>1,000</b>
S-1305	10 x 13"	42	197	183	171	155	1,000
S-6963	10 x 14"	48	206	193	179	164	1,000
S-3123	10 x 16"	50	221	205	191	174	1,000
S-17782	10 x 18"	27	129	118	109	98	500
S-17783	11 x 11"	44	197	187	176	160	1,000
S-2614	12 x 10"	43	204	193	181	161	1,000
S-1714	12 x 12"	48	205	196	183	164	1,000
S-14384	12 x 14"	27	118	109	98	90	500
<b>S-1306</b>	<b>12 x 15"</b>	<b>29</b>	<b>\$90 per carton any quantity</b>				<b>500</b>
S-14385	12 x 16"	31	128	117	108	97	500
S-12256	12 x 18"	33	130	120	111	99	500
S-15249	12 x 20"	40	148	139	127	118	500
S-17784	12 x 24"	45	173	161	149	139	500
S-3124	13 x 15"	32	119	112	106	96	500



# ULINE 4 AND 6 MIL RECLOSABLE BAGS



Superior strength, puncture-resistant poly with heavy-duty zipper for security.

- Archival quality, acid free for long-term storage.
- 100% virgin polyethylene film.
- Meets FDA and USDA specifications.

**4 MIL** – Heavyweight bags provide total protection from oil, dust and moisture.

**6 MIL** – Recommended for auto and machinery parts, electrical panels, printing plates and tools.



## 4 MIL

MODEL NO.	INSIDE W x L	LBS./CTN.	PRICE PER CARTON				QTY./CTN.
			1	5	10	25+	
S-1715	13 x 18"	34	\$131	\$122	\$114	\$103	500
S-15250	13 x 20"	39	158	147	138	125	500
S-15251	14 x 14"	31	127	118	109	98	500
S-13493	14 x 16"	33	175	161	146	131	500
S-10830	14 x 20"	42	209	196	180	163	500
S-2840	14 x 24"	48	251	230	211	196	500
S-15252	15 x 15"	38	150	140	127	117	500
S-3463	15 x 18"	42	202	190	169	154	500
S-7456	16 x 16"	40	159	147	138	125	500
S-14386	16 x 18"	46	203	191	177	163	500
S-12257	16 x 20"	48	210	197	183	171	500
S-15253	16 x 24"	54	285	264	244	227	500
S-3934	18 x 20"	56	275	258	238	223	500
S-7457	18 x 24"	34	165	154	141	129	250
S-12259	20 x 20"	32	163	151	140	127	250
S-7458	20 x 24"	38	179	166	153	141	250
S-14387	20 x 30"	48	222	205	193	176	250
S-10831	24 x 24"	45	206	195	182	171	250
S-14388	24 x 30"	24	143	132	122	114	100
S-17786	24 x 36"	30	169	155	144	133	100
S-12260	26 x 26"	20	124	114	106	97	100
S-14389	28 x 28"	24	150	140	129	120	100
S-14390	30 x 30"	28	171	158	147	139	100

## 6 MIL

MODEL NO.	INSIDE W x L	LBS./CTN.	PRICE PER CARTON				QTY./CTN.
			1	3	5	10+	
S-2608	5 x 8"	21	\$131	\$124	\$119	\$111	1,000
S-15259	5 x 10"	28	148	140	131	122	1,000
S-13430	6 x 6"	23	132	124	118	112	1,000
S-1663	6 x 8"	24	143	133	124	118	1,000
S-2842	6 x 9"	26	186	174	164	155	1,000
S-17767	6 x 10"	28	189	177	167	159	1,000
S-17768	6 x 12"	38	223	209	195	182	1,000
S-15260	7 x 8"	27	166	159	147	140	1,000
S-17769	7 x 10"	29	192	180	169	160	1,000
S-3282	8 x 8"	30	192	179	166	159	1,000
S-1664	8 x 10"	32	194	181	170	161	1,000
S-15261	8 x 12"	46	229	215	202	187	1,000
S-1665	9 x 12"	25	\$103 per carton any quantity				500
S-13431	10 x 10"	28	124	116	109	103	500
S-1666	10 x 12"	30	134	124	118	113	500
S-10826	10 x 13"	32	147	140	129	122	500
S-17770	10 x 14"	36	153	144	133	126	500
S-14407	10 x 16"	38	187	175	165	153	500
S-2609	12 x 12"	36	166	155	146	140	500
S-1667	12 x 15"	39	196	184	173	164	500
S-14408	12 x 18"	42	244	227	211	204	500
S-3283	13 x 15"	23	111	102	97	91	250
S-1668	13 x 18"	27	117	110	103	97	250
S-3487	14 x 14"	23	112	103	97	93	250
S-14409	14 x 16"	27	126	118	112	105	250
S-13432	14 x 20"	36	161	149	141	131	250
S-12294	14 x 24"	42	182	173	163	153	250
S-13433	15 x 18"	33	156	145	138	126	250
S-14410	16 x 16"	31	142	133	124	117	250
S-14411	16 x 18"	35	155	148	139	127	250
S-13434	16 x 20"	39	172	163	153	144	250
S-15262	18 x 18"	40	175	166	159	147	250
S-12295	18 x 20"	44	187	176	166	159	250
S-12296	18 x 24"	22	110	102	96	90	100
S-13435	20 x 20"	21	109	101	95	87	100
S-12297	20 x 24"	26	120	113	106	100	100
S-17771	20 x 30"	35	158	147	140	128	100
S-12298	24 x 24"	29	132	122	114	108	100
S-12299	26 x 26"	31	141	131	122	116	100
S-17772	28 x 30"	36	204	189	179	165	100

## 6 MIL

MODEL NO.	INSIDE W x L	LBS./CTN.	PRICE PER CARTON				QTY./CTN.
			1	3	5	10+	
S-12293	2 x 3"	5	\$75	\$69	\$65	\$61	1,000
S-15254	3 x 3"	6	85	80	76	71	1,000
S-2841	3 x 4"	7	97	91	86	80	1,000
S-10825	3 x 5"	9	100	95	90	84	1,000
S-17764	3 x 6"	11	101	96	90	84	1,000
S-15255	4 x 4"	8	98	93	87	82	1,000
S-1662	4 x 6"	14	102	97	91	85	1,000
S-15256	4 x 8"	19	126	119	113	106	1,000
S-15257	4 x 10"	26	139	129	122	116	1,000
S-17765	5 x 5"	14	103	97	93	87	1,000
S-17766	5 x 6"	16	114	108	101	96	1,000
S-15258	5 x 7"	18	130	123	118	110	1,000

# ULINE 8 MIL RECLOSABLE BAGS



Superior strength, puncture-resistant poly with heavy-duty zipper for security. 100% virgin polyethylene.

- Maximum protection for heavy industrial parts and sharp-edged materials.

8 MIL							
MODEL NO.	INSIDE W x L	LBS./CTN.	PRICE PER CARTON				QTY./CTN.
			1	3	5	10+	
S-15263	3 x 5"	11	\$105	\$98	\$92	\$86	1,000
S-17773	4 x 4"	12	107	100	93	87	1,000
S-14412	4 x 6"	16	109	102	96	90	1,000
S-14413	5 x 8"	25	129	122	116	108	1,000
S-15264	6 x 6"	25	143	134	128	119	1,000
S-15265	6 x 8"	31	151	144	138	126	1,000
S-14414	6 x 9"	33	197	187	175	165	1,000
S-17775	6 x 12"	45	243	229	217	204	1,000
S-20527	8 x 8"	41	225	212	198	184	1,000
S-13439	8 x 10"	50	254	236	223	208	1,000
S-15266	8 x 12"	29	147	140	132	123	500
S-13440	9 x 12"	33	165	158	146	140	500
S-14415	10 x 12"	36	195	181	171	161	500
S-14416	12 x 12"	43	229	217	205	191	500
S-13441	12 x 15"	55	258	243	228	215	500
S-17776	12 x 18"	33	144	134	128	119	250
S-13442	13 x 18"	36	149	141	133	124	250
S-14417	14 x 24"	48	246	231	218	205	250
S-13443	16 x 20"	47	238	226	213	200	250
S-13444	18 x 24"	24	141	133	124	118	100
S-17777	20 x 20"	24	138	129	119	113	100
S-15267	20 x 24"	29	158	147	140	131	100
S-14418	24 x 24"	32	194	180	170	161	100
S-15268	28 x 30"	25	139	129	120	114	50

# ULINE WHITE BLOCK RECLOSABLE



Recommended for auto and machinery parts, electrical panels, printing plates and tools.

- White Block – Clearly label your parts.

6 MIL WHITE BLOCK							
MODEL NO.	INSIDE W x L	LBS./CTN.	PRICE PER CARTON				QTY./CTN.
			1	3	5	10+	
S-12300	3 x 5"	9	\$118	\$112	\$106	\$99	1,000
S-6968	4 x 6"	14	128	119	113	107	1,000
S-13436	5 x 7"	18	186	175	167	158	1,000
S-15269	6 x 8"	24	211	200	188	175	1,000
S-6969	6 x 9"	27	223	212	201	186	1,000
S-13437	8 x 8"	30	247	231	214	193	1,000
S-6970	8 x 10"	42	266	251	237	217	1,000
S-6971	9 x 12"	27	161	151	144	132	500
S-6972	10 x 12"	31	182	174	166	149	500
S-12301	12 x 12"	36	211	201	192	171	500
S-6973	12 x 15"	45	263	251	237	215	500
S-12302	13 x 18"	27	165	158	146	134	250
S-12303	14 x 24"	42	242	228	215	196	250
S-13438	18 x 20"	44	254	239	227	209	250



## VENT HOLE BAGS

### RECLOSABLE

Eliminate trapped air. Easy to use.

- Package apparel, blankets and seasonal items.
- Single-track zipper.

FDA/USDA COMPLIANT

MODEL NO.	INSIDE W x L	MIL	PRICE PER CARTON			QTY./CTN.
			1	3	5+	
S-12448	6 x 9"	2	\$63	\$60	\$56	1,000
S-12449	9 x 12"		90	85	81	1,000
S-12450	12 x 15"		142	132	123	1,000

Keep track of small items like spare parts, nuts and bolts.

- White block area – Use marker, ballpoint pen or pencil.
- Identify contents of bags without using a label.
- All virgin polyethylene film meets FDA and USDA requirements.
- Combine sizes for volume discount.



**IN STOCK – SHIPS TODAY**

2 MIL WHITE BLOCK							
MODEL NO.	INSIDE W x L	LBS./ CTN.	PRICE PER CARTON				QTY./ CTN.
			1	5	10	25+	
S-12261	1½ x 2"	1	\$29	\$26	\$21	\$17	1,000
S-2010	2 x 2"	1	30	28	23	19	1,000
S-1905	2 x 3"	2	31	29	24	20	1,000
S-12262	2 x 4"	2	33	30	25	21	1,000
S-2822	2 x 6"	3	39	35	29	25	1,000
S-3795	3 x 3"	3	36	32	26	23	1,000
S-2012	3 x 4"	3	38	33	27	24	1,000
<b>S-1307</b>	<b>3 x 5"</b>	<b>4</b>	<b>\$24 per carton any quantity</b>				<b>1,000</b>
S-13494	3 x 6"	6	46	42	35	32	1,000
S-3252	4 x 4"	5	45	41	34	31	1,000
S-3493	4 x 5"	6	47	43	36	33	1,000
<b>S-1308</b>	<b>4 x 6"</b>	<b>6</b>	<b>\$33 per carton any quantity</b>				<b>1,000</b>
S-2823	4 x 8"	7	53	48	43	38	1,000
S-6737	4 x 10"	9	58	52	46	40	1,000
S-6738	5 x 5"	6	50	45	39	36	1,000
S-3796	5 x 7"	8	56	51	44	39	1,000
S-1906	5 x 8"	10	58	52	46	40	1,000
S-12263	6 x 6"	8	56	51	44	39	1,000
S-3494	6 x 8"	10	68	62	54	50	1,000
<b>S-1309</b>	<b>6 x 9"</b>	<b>10</b>	<b>\$50 per carton any quantity</b>				<b>1,000</b>
S-10849	6 x 10"	11	71	66	59	54	1,000
S-10850	6 x 12"	12	79	72	64	58	1,000
S-13495	7 x 8"	11	75	69	60	54	1,000
S-3253	8 x 8"	12	83	76	66	61	1,000
S-1310	8 x 10"	16	98	90	79	72	1,000
S-10851	8 x 12"	19	104	96	87	78	1,000
S-1907	9 x 12"	18	117	108	97	89	1,000
S-3495	10 x 10"	20	142	131	116	103	1,000
S-3254	10 x 12"	24	147	134	118	107	1,000
S-3496	10 x 13"	26	149	137	120	109	1,000
S-10852	10 x 15"	30	159	149	133	121	1,000
S-13496	12 x 12"	24	168	156	149	131	1,000
S-3497	12 x 13"	26	176	165	158	139	1,000
S-2013	12 x 15"	28	179	166	159	140	1,000
S-14424	12 x 18"	29	210	192	184	163	1,000
S-3498	13 x 15"	30	194	177	169	151	1,000

2 MIL WHITE BLOCK							
MODEL NO.	INSIDE W x L	LBS./ CTN.	PRICE PER CARTON				QTY./ CTN.
			1	5	10	25+	
S-3797	13 x 18"	37	\$207	\$189	\$182	\$160	1,000
S-14425	14 x 16"	20	154	146	138	119	500
S-12264	14 x 20"	23	192	176	168	149	500
S-12265	18 x 20"	30	214	195	187	166	500
S-12266	18 x 24"	35	234	215	205	184	500
S-12267	20 x 24"	20	126	114	109	101	250
S-12268	24 x 24"	24	158	145	140	124	250

4 MIL WHITE BLOCK							
MODEL NO.	INSIDE W x L	LBS./ CTN.	PRICE PER CARTON				QTY./ CTN.
			1	5	10	25+	
S-12269	2 x 3"	4	\$56	\$54	\$51	\$46	1,000
S-2617	2½ x 3"	4	61	60	58	50	1,000
S-494	3 x 4"	6	62	61	59	51	1,000
S-495	3 x 5"	7	64	63	60	53	1,000
S-6964	4 x 4"	7	67	64	61	56	1,000
S-496	4 x 6"	10	81	79	75	63	1,000
S-13497	5 x 7"	13	99	96	90	81	1,000
S-497	5 x 8"	15	108	105	99	85	1,000
S-6965	6 x 6"	13	101	97	91	82	1,000
S-3798	6 x 8"	18	116	110	106	91	1,000
S-498	6 x 9"	19	126	120	114	101	1,000
S-6966	6 x 10"	21	139	131	125	112	1,000
S-10853	6 x 12"	27	150	142	135	125	1,000
S-3799	8 x 8"	23	160	152	148	130	1,000
S-1908	8 x 10"	27	180	170	163	145	1,000
S-2484	9 x 12"	38	212	203	192	167	1,000
S-10854	10 x 10"	39	210	201	190	165	1,000
S-2485	10 x 12"	40	216	207	196	171	1,000
S-3500	10 x 13"	41	221	211	201	175	1,000
S-6967	12 x 12"	48	229	219	209	184	1,000
S-2486	12 x 15"	30	121	117	110	93	500
S-3800	13 x 18"	43	159	151	146	124	500
S-12270	14 x 20"	49	209	196	183	164	500
S-10855	14 x 24"	51	247	231	217	200	500
S-12271	18 x 20"	32	141	132	126	113	250
S-12272	18 x 24"	38	173	163	149	140	250
S-13498	20 x 24"	43	193	181	167	153	250
S-12273	24 x 24"	49	217	208	197	172	250



# ULINE SLIDER ZIP BAGS



Slide lock glides easily across bag, protecting contents from dirt and moisture.

- Durable and reusable. • Easy open, easy close.
- Bags are pre-opened for quick handling.
- FDA and USDA compliant for food contact.



## WHITE BLOCK

Keep small parts and products organized.

- White block area for use with pen or marker.



## HEFTY® SLIDER BAGS

Guaranteed to produce a durable, airtight seal every time.

- Protect items from dirt and moisture.
- Freezer safe, acid free and archival safe.
- FDA and USDA compliant for food contact.

MODEL NO.	SIZE W x L	MIL	PRICE PER CARTON			QTY./CTN.
			1	3	5+	
S-10832	4 x 6"	3	\$12	\$11	\$10	100
S-14444	5 x 7"		13	12	11	
S-10833	6 x 9"		16	14	13	
S-12315	6½ x 6"		13	12	11	
S-3633	8 x 6"		15	13	12	
S-13421	8 x 8"		17	15	14	
S-12316	8 x 10"		18	16	15	
S-10834	9 x 12"	3	22	20	18	100
S-3634	10 x 7"		18	16	15	
S-14445	10 x 13"		23	21	19	
S-14446	12 x 12"		27	24	22	
S-12317	12 x 15"		30	27	24	
S-13422	13 x 18"		40	37	33	
S-3635	12½ x 9"		\$17 per carton any qty.			
S-3636	14 x 10"	3	27	24	22	100
S-3637	16 x 12"		34	32	29	
S-10835	16 x 16"		44	40	36	
S-12318	16 x 18"		47	43	39	
S-12319	18 x 20"		56	51	47	
S-17704	18 x 24"		67	61	56	
S-13423	20 x 20"		64	58	53	
S-14447	22 x 22"	72	67	61		

### WHITE BLOCK

S-12320	4 x 6"	3	\$15	\$13	\$12	100
S-10840	6 x 9"		18	16	15	
S-10839	8 x 6"		17	15	14	
S-11148	9 x 12"		28	25	23	
S-14448	12½ x 9"		29	27	24	
S-10841	16 x 12"		37	34	30	
S-12321	16 x 16"		49	45	41	



## ULINE JUMBO SLIDER ZIP BAGS

XL/XXL

Humongous bags. Use for seasonal storage.

- Flexible – Store where rigid containers and boxes won't fit.
- Slider zip for easy open and close.
- Die-cut handle for easy transport.

MODEL NO.	SIZE W x L	CAP. (GAL.)	MIL	PRICE PER CARTON			QTY./CTN.
				1	3	5+	
S-14518	24 x 20"	11	3.5	\$80	\$77	\$74	32
S-14519	24 x 32"	22		80	77	74	24

## ULINE RESEALABLE BAGS



Quickly package your items with self-seal adhesive lip.

- Peel back release strip and fold lip to seal.
- 1½" resealable lip.
- 4 MIL – Recommended for heavier items.
- 100% virgin polyethylene film.

### 1.5 MIL

MODEL NO.	SIZE W x L	QTY./ CTN.	LBS./ CTN.	PRICE PER CARTON		
				1	5	10+
S-14474	3 x 4"	1,000	2	\$29	\$27	\$26
S-11062	3 x 5"	1,000	2	30	28	27
S-9818	4 x 6"	1,000	3	35	34	33
S-12274	4 x 10"	1,000	4	38	37	35
S-12275	5 x 5"	1,000	3	35	34	33
S-12277	5 x 7"	1,000	4	41	38	36
S-14475	6 x 6"	1,000	4	41	38	36
S-5065	6 x 8"	1,000	6	42	39	37
S-14476	6 x 9"	1,000	7	43	41	38
S-20313	6 x 12"	1,000	8	54	50	48
S-5066	7 x 10"	1,000	8	50	48	45
S-14477	8 x 10"	1,000	9	54	50	48
S-5067	9 x 12"	1,000	12	66	63	59
S-14478	10 x 12"	1,000	13	70	67	64
S-11063	10 x 13"	1,000	15	75	69	66
S-5068	10 x 15"	1,000	17	83	78	75
S-12278	11 x 14"	1,000	18	80	77	71
S-10611	12 x 12"	1,000	16	78	75	69
S-11064	12 x 15"	1,000	20	98	93	87
S-5069	12 x 18"	1,000	23	112	106	100
S-20314	14 x 16"	1,000	24	108	102	98
S-20315	14 x 18"	1,000	28	116	109	103
S-10612	16 x 20"	500	17	80	77	71
S-9819	18 x 24"	500	25	99	93	87
S-10613	20 x 24"	500	26	111	105	100
S-20316	24 x 24"	500	30	139	131	125

### 4 MIL

MODEL NO.	SIZE W x L	QTY./ CTN.	LBS./ CTN.	PRICE PER CARTON		
				1	5	10+
S-13477	6 x 9"	500	7	\$43	\$41	\$38
S-13478	7 x 10"	500	10	54	50	48
S-8478	9 x 12"	500	15	70	67	64
S-8479	10 x 12"	500	18	78	76	70
S-13479	10 x 13"	500	19	86	81	77
S-13481	12 x 15"	500	27	100	96	90
S-11065	12 x 18"	500	31	108	102	98
S-12279	16 x 20"	250	24	107	101	97
S-12280	20 x 24"	250	35	135	129	123

## ULINE DRAWSTRING BAGS



Reusable and durable.

- Attach bags directly to equipment or products.
- Ideal for holding parts, instructions and samples.
- 100% cotton drawstring.

### 2 MIL

\* SPECIFY COLOR: Clear or White

MODEL NO.	INSIDE W x L	QTY./ CTN.	LBS./ CTN.	PRICE PER CARTON		
				1	3	5+
S-2702	3 x 5"	2,000	7	\$109	\$102	\$93
S-2703	4 x 6"	2,000	10	147	138	127
S-2704	5 x 8"	2,000	15	166	154	144
S-14479	6 x 8"	2,000	18	202	189	175
S-2705*	6 x 10"	1,000	11	105	97	90
S-2706	8 x 10"	1,000	14	132	124	116
S-2707*	9 x 12"	1,000	18	148	140	129
S-5371	9½ x 14"	1,000	20	170	159	147
S-14481	10 x 12"	1,000	20	166	154	144
S-14482	12 x 15"	1,000	30	221	205	191
S-2910*	12 x 18"	1,000	33	242	224	207
S-5372	15 x 18"	1,000	42	263	246	227
S-11056	16 x 24"	500	30	225	209	194
S-11057	18 x 24"	250	18	129	120	112
S-17719	20 x 24"	250	19	150	142	131

### 4 MIL

MODEL NO.	INSIDE W x L	QTY./ CTN.	LBS./ CTN.	PRICE PER CARTON		
				1	3	5+
S-11058	3 x 5"	2,000	14	\$196	\$181	\$169
S-11059	6 x 10"	1,000	22	172	161	147
S-15274	9 x 12"	500	17	137	128	118
S-14483	12 x 18"	500	34	212	196	182
S-11060	15 x 18"	250	21	153	144	132
S-14484	16 x 24"	250	29	189	174	163
S-11061	18 x 24"	250	33	217	202	186



## GUSSETED BAGS

### RESEALABLE

Ship or store bulky items.

- Expandable bottom.
- 100% virgin polyethylene film.

### 2 MIL

MODEL NO.	SIZE W x L x D	QTY./ CTN.	LBS./ CTN.	PRICE PER CARTON		
				1	5	10+
S-12281	6 x 9 x 2"		10	\$51	\$48	\$46
S-12282	9 x 12 x 4"	1,000	19	93	89	83
S-12283	12 x 18 x 4"		34	145	138	129

# COLORED POLY BAGS



2 MIL OPEN END							
MODEL NO.	OUTSIDE W x L	LBS./ CTN.	PRICE PER CARTON				QTY./ CTN.
			1	5	10	20+	
S-15156	4 x 6"	3	\$31	\$29	\$28	\$26	1,000
S-15157	6 x 9"	8	47	45	42	40	
S-15159	9 x 12"	14	79	73	70	66	
S-15160	12 x 15"	25	114	108	102	96	
S-15161	15 x 18"	37	160	150	144	134	



2 MIL RECLOSABLE							
MODEL NO.	INSIDE W x L	LBS./ CTN.	PRICE PER CARTON				QTY./ CTN.
			1	5	10	25+	
S-15270	2 x 3"	2	\$24	\$22	\$20	\$18	1,000
S-16477	3 x 3"	3	30	28	25	22	
S-12322	3 x 5"	4	36	32	28	25	
S-10845	4 x 6"	6	43	39	36	32	
S-15271	5 x 8"	8	61	56	50	47	
S-10847	6 x 9"	12	83	75	67	62	1,000
S-14520	8 x 10"	16	99	91	85	80	
S-12323	9 x 12"	21	118	112	104	96	
S-10848	10 x 12"	24	134	125	116	105	
S-13428	12 x 15"	38	196	188	173	160	

Color code your products or inventory.

- Resist dust, dirt and moisture.
- Recommended for parts distributors, dealerships.
- 100% virgin low-density polyethylene.

SPECIFY COLOR: Blue, Red, Yellow, White, Green or Black

# AMBER UV BAGS



Maximum UV protection for light-sensitive products.

- Recommended for electronics, computer parts and film.
- Airtight zipper keeps out dust, dirt and moisture.

3 MIL							
MODEL NO.	INSIDE W x L	LBS./ CTN.	PRICE PER CARTON			QTY./ CTN.	
			1	3	5+		
S-22738	2 x 3"	3	\$27	\$25	\$21	1,000	
S-11169	3 x 5"	4	37	32	28		
S-22739	3 x 9"	5	51	45	40		
S-12285	4 x 6"	6	51	45	40		
S-22740	5 x 8"	9	74	65	57		
S-11170	6 x 8"	11	86	78	65	1,000	
S-13770	8 x 8"	12	108	97	84		
S-13771	8 x 14"	21	158	141	124		
S-12286	9 x 12"	21	168	149	129		
S-11171	12 x 12"	28	243	210	180		
S-20530	12 x 15"	38	277	236	208		



# DOUBLE ZIPPER BAGS

Strong double-seal bags lock out air and moisture.

- Securely closes on the first try.
- Leak resistant and freezer safe.

FDA AND USDA COMPLIANT							
MODEL NO.	SIZE W x L	MIL	PRICE PER CARTON			QTY./ CTN.	
			1	5	10+		
S-17788	6 x 9"	2.7	\$52	\$48	\$43	500	
S-20325	7 x 8"		40	37	35	300	
S-17789	9 x 12"		49	46	41	250	
S-17790	10 x 11"		41	38	36	200	
S-17791	13 x 15"		40	37	35	100	



# ULINE PARTS BAGS

4 MIL

MODEL NO.	INSIDE W x L	LBS./ CTN.	PRICE PER CARTON			QTY./ CTN.
			1	3	5+	
S-2824	2 x 3"	4	\$51	\$50	\$49	1,000
S-2682	3 x 4"	6	61	58	54	
S-3255	3 x 5"	7	62	59	56	
S-2683	4 x 6"	9	73	70	67	
S-2825	5 x 8"	13	96	91	88	
S-2684	6 x 8"	17	103	101	96	1,000
S-3256	6 x 9"	19	111	109	106	
S-22667	6 x 10"	21	136	131	126	
S-2826	8 x 10"	27	174	165	154	
S-2685	9 x 12"	33	188	177	166	
S-12437	10 x 10"	37	206	194	182	500
S-3488	10 x 12"	22	108	102	96	
S-10827	10 x 18"	30	149	144	132	
S-12438	12 x 12"	26	129	120	114	
S-3489	12 x 15"	30	162	153	143	
S-12439	12 x 18"	35	194	182	171	250
S-12440	14 x 24"	26	159	148	140	

Easily identify part numbers and quantities with pre-printed white block bags.

- Hang or tie reclosable parts bags to equipment, machinery or racks.
- Heavy-duty single track zipper with 1/4" hang hole.



RECLOSABLE WITH HANG HOLE

# ULINE HANG HOLE BAGS

2 MIL TOP SIDE

MODEL NO.	INSIDE W x L	LBS./ CTN.	PRICE PER CARTON			QTY./ CTN.
			1	3	5+	
S-3314	2 x 3"	2	\$25	\$24	\$22	1,000
S-6974	3 x 4"	3	30	29	26	
S-3315	3 x 5"	4	33	30	28	
S-20300	3 x 6"	5	34	32	30	
S-14439	4 x 4"	5	33	31	29	
S-3316	4 x 6"	5	36	34	31	1,000
S-3317	5 x 8"	8	53	48	43	
S-14440	5 x 10"	10	56	53	48	
S-3318	6 x 9"	11	57	54	49	
S-23478	6 x 12"	13	65	62	58	
S-12441	8 x 10"	16	71	69	64	500
S-3319	9 x 12"	19	80	77	74	
S-3802	10 x 12"	26	95	90	83	

Protect key documents, parts, samples, etc., and attach to machinery.

- Hang **reclosable** bags from racks.
- Recommended for storing and displaying inspection data, item information, warranties and permits.
- Twist tie not included.

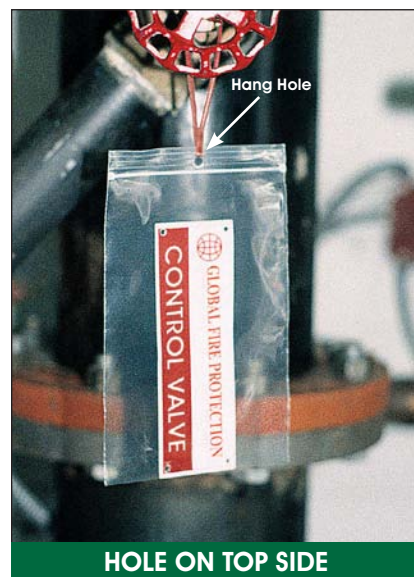

HOLE ON TOP SIDE

4 MIL TOP SIDE

S-14442	3 x 4"	3	\$23	\$22	\$21	500
S-3320	3 x 5"	4	26	25	24	
S-3321	4 x 6"	5	30	30	27	
S-3322	5 x 8"	8	35	34	32	
S-20301	6 x 6"	8	34	33	30	
S-3323	6 x 9"	11	49	46	43	500
S-12443	8 x 10"	16	66	62	58	
S-6975	9 x 12"	19	76	72	66	
S-12444	12 x 15"	33	113	106	99	

Bottom Side Opening – Easy access to contents. Reinforced grommet. Tie included.

4 MIL BOTTOM SIDE

MODEL NO.	INSIDE W x L	LBS./ CTN.	PRICE PER CARTON			QTY./ CTN.
			1	3	5+	
S-12445	4 x 6"	7	\$42	\$41	\$38	500
S-12446	6 x 9"	13	68	65	62	
S-12447	9 x 12"	22	100	91	86	

BOTTOM SIDE



TOP SIDE

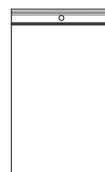

HOLE ON BOTTOM SIDE



# MINIGRIP® WHITE BLOCK BAGS

**IN STOCK – SHIPS TODAY**

Quickly identify items in these premium-quality white block bags.

- Mark easily with pen, marker, rubber stamp or grease pencil.
- Reinforced zipper closes and locks in one motion.
- Meets FDA and USDA specifications.



2 MIL						
MODEL NO.	INSIDE W x L	LBS./ CTN.	PRICE PER CARTON			QTY./ CTN.
			1	5	10+	
S-293	2 x 3"	2	\$37	\$33	\$27	1,000
S-381	3 x 4"	3	42	36	29	
S-294	3 x 5"	3	43	38	31	
S-295	4 x 6"	5	60	52	43	
S-296	5 x 8"	8	69	59	50	
S-297	6 x 9"	9	83	72	58	
S-15275	8 x 10"	14	107	94	81	
S-1888	9 x 12"	19	128	114	96	

4 MIL WITH HANG HOLES						
MODEL NO.	INSIDE W x L	LBS./ CTN.	PRICE PER CARTON			QTY./ CTN.
			1	5	10+	
S-1676	3 x 4"	5	\$74	\$68	\$56	1,000
S-1677	3 x 5"	6	83	72	60	
S-1678	4 x 6"	9	96	87	71	
S-1679	5 x 8"	14	128	110	93	
S-1680	6 x 9"	18	136	119	100	
S-1889	8 x 10"	27	190	173	156	
S-1890	9 x 12"	34	198	181	158	

## WHIRL-PAK® BAGS



Collect soil and specimen samples in super-strong blended polyethylene.

- Whirl bag shut, fold ends to create airtight, leakproof seal.
- Sterile. Meets FDA and USDA specifications.

White Block – Write-on area for quick, easy labeling.

### WHITE BLOCK

MODEL NO.	OUTER DIM. W x L	CAP. (OZ.)	MIL	PRICE PER CARTON			QTY./ CTN.
				1	3	5+	
S-22729	3 x 5"	2	2.25	\$91	\$85	\$81	500
S-19792	3 x 7¼"	4	2.25	94	88	84	
S-19793	4½ x 9"	18	2.5	130	125	118	
S-19794	6 x 9"	24	3.0	170	160	152	
S-22730	7½ x 15"	69	3.0	290	279	267	

### STANDARD

MODEL NO.	OUTER DIM. W x L	CAP. (OZ.)	MIL	PRICE PER CARTON			QTY./ CTN.
				1	3	5+	
S-20317	3 x 5"	2	2.25	\$85	\$80	\$76	500
S-16551	3 x 7¼"	4	2.25	87	82	77	
S-16552	4½ x 9"	18	2.5	118	113	106	
S-16553	6 x 9"	24	3.0	155	147	139	
S-16554	5 x 15"	36	3.0	190	180	170	
S-20318	6 x 15"	42	3.0	215	204	193	
S-20319	7½ x 15"	69	3.0	241	230	219	

## LEAKPROOF BAGS



Safely store liquids and samples in liquid-tight polyethylene.

- Double-locking zipper is airtight.
- Meets FDA and USDA specifications.

MODEL NO.	OUTER DIMENSIONS W x L	MIL	PRICE PER CARTON			QTY./ CTN.
			1	3	5+	
S-17703	3 x 6"	3	\$111	\$103	\$99	250
S-5854	6 x 6"		133	126	119	
S-5855	7 x 8"		149	139	129	
S-5856	9 x 12"		206	193	180	
S-11167	12 x 12"		253	234	219	
S-11168	16 x 16"		140	130	120	
S-12284	24 x 24"		255	243	230	

# MINIGRIP® RECLOSABLE BAGS

OVER 70 SIZES IN STOCK

Premium quality bags provide superior clarity.

- Heavy-duty zipper prevents seams from splitting.
- Squeeze zipper to seal. Leak resistant.
- Combine sizes for volume discounts.



6 Mil – Recommended for heavy-duty protection.



2 MIL							
MODEL NO.	INSIDE W x L	LBS./ CTN.	PRICE PER CARTON				QTY./ CTN.
			1	5	10	25+	
S-247	2 x 2"	2	\$33	\$29	\$24	\$20	1,000
S-267	2 x 3"	2	\$19 per carton any quantity				1,000
S-643	3 x 3"	2	40	36	30	25	1,000
S-266	3 x 4"	3	42	37	31	26	1,000
S-268	3 x 5"	4	44	38	32	27	1,000
S-2043	3 x 6"	4	50	43	36	31	1,000
S-644	4 x 4"	4	47	40	33	28	1,000
S-269	4 x 6"	5	\$29 per carton any quantity				1,000
S-1875	4 x 7"	5	53	48	42	38	1,000
S-2045	5 x 5"	6	64	56	49	41	1,000
S-645	5 x 7"	7	57	51	43	37	1,000
S-270	5 x 8"	8	61	53	46	39	1,000
S-2046	5 x 10"	9	75	68	59	53	1,000
S-646	6 x 6"	7	68	57	50	42	1,000
S-578	6 x 8"	9	72	61	52	45	1,000
S-271	6 x 9"	10	\$48 per carton any quantity				1,000
S-579	6 x 10"	11	82	69	59	53	1,000
S-2048	6 x 12"	12	90	78	70	65	1,000
S-647	8 x 8"	12	86	73	64	57	1,000
S-648	8 x 10"	15	100	87	70	63	1,000
S-2049	8 x 12"	16	113	103	89	85	1,000
S-272	9 x 12"	19	\$72 per carton any quantity				1,000
S-595	10 x 12"	22	120	107	95	90	1,000
S-596	10 x 13"	23	127	109	102	98	1,000
S-597	12 x 12"	25	135	116	109	102	1,000
S-649	12 x 15"	30	155	136	130	125	1,000
S-598	13 x 15"	33	161	145	141	135	1,000
S-2050	13 x 18"	37	209	199	194	186	1,000

4 MIL							
MODEL NO.	INSIDE W x L	LBS./ CTN.	PRICE PER CARTON				QTY./ CTN.
			1	5	10	25+	
S-485*	2½ x 3"	4	\$54	\$50	\$43	\$41	1,000
S-1877*	2½ x 6"	7	73	65	56	51	1,000
S-484*	3 x 4"	6	66	59	53	49	1,000
S-486*	3 x 5"	7	69	61	53	49	1,000
S-599*	4 x 4"	7	73	65	56	51	1,000
S-487*	4 x 6"	10	76	67	58	53	1,000
S-488*	5 x 8"	16	98	87	75	67	1,000
S-770*	6 x 6"	15	107	95	86	78	1,000
S-771*	6 x 8"	18	118	105	94	89	1,000
S-489	6 x 9"	19	121	107	96	93	1,000
S-2002	8 x 8"	23	142	124	111	107	1,000
S-772	8 x 10"	28	153	137	120	116	1,000
S-490	9 x 12"	34	175	156	145	136	1,000
S-2003*	10 x 12"	21	101	92	88	80	500
S-1884	10 x 13"	23	122	112	106	98	500
S-773	12 x 12"	26	110	100	92	89	500
S-774	12 x 15"	30	127	118	112	105	500
S-776	13 x 18"	37	152	138	132	128	500
S-2005	13 x 20"	20	116	105	94	88	250
S-1886	14 x 24"	25	124	115	110	104	250

6 MIL							
MODEL NO.	INSIDE W x L	LBS./ CTN.	PRICE PER CARTON				QTY./ CTN.
			1	3	6	10+	
S-6976	4 x 6"	6	\$65	\$59	\$56	\$53	500
S-6977	6 x 8"	12	90	83	74	72	500
S-6978	8 x 10"	20	118	108	99	95	500
S-6979	9 x 12"	26	145	131	121	117	500
S-6980	10 x 12"	30	149	134	124	120	500
S-6981	12 x 15"	23	126	114	111	107	250
S-6982	13 x 18"	27	134	123	120	115	250

\*With Hang Holes

## SPECIMEN BAGS

Used in hospitals and medical labs to safely transfer specimens, paperwork and sample cups.

MODEL NO.	OUTER DIM. W x L	MIL	PRICE PER CARTON			QTY./ CTN.
			1	3	5+	
S-2968	6 x 9"	2	\$62 per carton any quantity			1,000
S-22706	12 x 15"		\$147	\$140	\$134	

- Zipper bag holds specimen – Prevents spills.
- Outer pouch keeps paperwork separate and secure.





# ULINE 1 MIL POLY BAGS



## ULINE POLY BAGS

- Meet FDA and USDA specifications for food contact.
- 100% virgin, high clarity polyethylene film.
- Available in 1-8 mil thicknesses to suit all your packaging and storage needs.
- Over 1,000 sizes to choose from.
- Larger volumes – Call for quote.

Bag Tape and Twist Ties, see page 138.

- 1 Mil – Lightweight protection for temporary storage.
- 2 Mil – Most popular thickness for shipping parts, clothing or protecting food.
- 3 Mil – Added protection for parts and hardware.
- 4 Mil – Heavier protection for industrial parts and tools.
- 6 Mil – Protects against punctures and tears.
- 8 Mil – Super heavyweight bags for maximum strength.

MODEL NO.	OUTSIDE W x L	LBS./ CTN.	PRICE PER CARTON				QTY./ CTN.
			1	5	10	20+	
S-5387	2 x 3"	1	\$9	\$9	\$8	\$8	1,000
S-5785	2 x 4"	1	11	11	10	10	1,000
S-3988	3 x 4"	1	14	13	13	12	1,000
S-3638	3 x 5"	1	14	13	13	12	1,000
S-5786	3 x 6"	2	15	14	14	13	1,000
S-6298	3 x 7"	2	15	14	14	13	1,000
S-6299	3 x 8"	2	15	14	14	13	1,000
S-10856	3 x 10"	2	16	15	15	14	1,000
S-10857	3 x 12"	2	17	17	16	15	1,000
S-3989	4 x 4"	1	14	13	13	12	1,000
S-10859	4 x 5"	1	14	13	13	12	1,000
<b>S-2946</b>	<b>4 x 6"</b>	<b>2</b>	<b>\$13 per carton any quantity</b>				<b>1,000</b>
S-10860	4 x 7"	2	16	15	15	14	1,000
S-3450	4 x 8"	2	16	15	15	14	1,000
S-15069	4 x 9"	3	17	17	16	15	1,000
S-6300	4 x 10"	3	20	19	18	17	1,000
S-6301	4 x 12"	4	21	20	19	18	1,000
S-10861	4 x 16"	4	22	21	20	19	1,000
S-10863	5 x 5"	2	15	14	14	13	1,000
S-5787	5 x 6"	2	16	15	15	14	1,000
S-2947	5 x 7"	3	16	15	15	14	1,000
S-3639	5 x 8"	3	20	19	18	17	1,000
S-12287	5 x 9"	4	21	20	19	18	1,000
S-5388	5 x 10"	4	22	21	20	19	1,000
S-6302	5 x 12"	4	26	23	22	21	1,000
S-10864	5 x 14"	5	28	27	26	23	1,000
S-15070	5 x 15"	5	32	30	28	27	1,000
S-10865	5 x 16"	5	35	34	32	29	1,000
S-10867	5 x 20"	7	39	38	36	35	1,000
S-10868	5 x 24"	8	44	41	39	37	1,000

MODEL NO.	OUTSIDE W x L	LBS./ CTN.	PRICE PER CARTON				QTY./ CTN.
			1	5	10	20+	
S-5389	6 x 6"	3	\$20	\$19	\$18	\$17	1,000
S-10869	6 x 7"	3	21	20	19	18	1,000
<b>S-2948</b>	<b>6 x 8"</b>	<b>3</b>	<b>\$17 per carton any quantity</b>				<b>1,000</b>
S-3451	6 x 9"	4	21	20	19	18	1,000
S-5390	6 x 10"	4	22	21	20	19	1,000
S-5391	6 x 12"	5	27	26	23	22	1,000
S-6303	6 x 14"	6	32	30	28	27	1,000
S-13459	6 x 16"	7	36	35	34	30	1,000
S-10870	6 x 18"	7	37	35	35	32	1,000
S-10871	6 x 20"	8	39	38	36	35	1,000
S-10872	6 x 24"	10	44	41	39	37	1,000
S-10873	6 x 30"	12	51	48	45	43	1,000
S-10874	7 x 7"	3	21	20	19	18	1,000
S-6304	7 x 8"	4	22	21	20	19	1,000
S-5788	7 x 9"	5	22	21	20	19	1,000
S-3640	7 x 10"	6	27	23	22	21	1,000
S-5392	7 x 12"	7	29	28	26	23	1,000
S-10875	7 x 14"	7	35	34	32	29	1,000
S-10876	7 x 16"	7	37	35	35	32	1,000
S-10877	7 x 18"	8	39	38	36	35	1,000
S-6305	8 x 8"	5	22	21	20	19	1,000
S-2949	8 x 10"	6	27	26	23	22	1,000
S-3641	8 x 12"	7	32	30	28	27	1,000
S-10879	8 x 14"	7	37	35	35	32	1,000
S-15071	8 x 15"	8	39	38	36	35	1,000
S-6306	8 x 16"	9	43	40	38	36	1,000
S-6307	8 x 18"	10	47	45	43	40	1,000
S-10880	8 x 20"	11	52	49	46	44	1,000
S-10881	8 x 24"	13	56	53	51	47	1,000
S-10882	9 x 9"	5	29	28	26	24	1,000

# ULINE 1 MIL POLY BAGS

145 SIZES IN STOCK



MODEL NO.	OUTSIDE W x L	LBS./ CTN.	PRICE PER CARTON				QTY./ CTN.
			1	5	10	20+	
S-10883	9 x 10"	6	\$35	\$34	\$32	\$29	1,000
S-17555	9 x 11"	7	36	35	34	32	1,000
<b>S-3202</b>	<b>9 x 12"</b>	<b>8</b>	<b>\$29 per carton any quantity</b>				<b>1,000</b>
S-3990	9 x 14"	9	39	38	36	35	1,000
S-17556	9 x 15"	9	40	38	37	35	1,000
S-10884	9 x 16"	10	45	43	40	38	1,000
S-5393	9 x 18"	11	51	48	45	43	1,000
S-10885	9 x 20"	12	53	51	47	45	1,000
S-10886	9 x 24"	14	56	53	51	47	1,000
S-10887	10 x 10"	7	36	35	34	30	1,000
S-2950	10 x 12"	8	38	36	35	34	1,000
<b>S-3203</b>	<b>10 x 14"</b>	<b>10</b>	<b>\$37 per carton any quantity</b>				<b>1,000</b>
S-6308	10 x 15"	11	49	46	44	41	1,000
S-5395	10 x 16"	12	51	48	45	43	1,000
S-10888	10 x 18"	12	56	53	48	46	1,000
S-10889	10 x 20"	13	62	60	57	53	1,000
S-6309	10 x 24"	16	74	70	66	63	1,000
S-10890	10 x 30"	20	87	83	80	73	1,000
S-17557	10 x 36"	24	95	89	85	81	1,000
S-10891	11 x 12"	9	39	38	36	35	1,000
S-10892	11 x 14"	10	49	46	44	41	1,000
S-10893	11 x 16"	12	54	51	47	45	1,000
S-10894	11 x 18"	13	57	54	51	47	1,000
S-3642	12 x 12"	10	47	45	43	40	1,000
S-3643	12 x 14"	12	53	51	47	45	1,000
<b>S-6310</b>	<b>12 x 15"</b>	<b>12</b>	<b>\$47 per carton any quantity</b>				<b>1,000</b>
S-5396	12 x 16"	13	57	54	51	47	1,000
<b>S-3204</b>	<b>12 x 18"</b>	<b>15</b>	<b>\$49 per carton any quantity</b>				<b>1,000</b>
S-5397	12 x 20"	16	73	70	66	63	1,000
S-3452	12 x 24"	19	82	79	72	68	1,000
S-12288	12 x 30"	25	87	83	80	72	1,000
S-10895	12 x 36"	29	98	93	87	83	1,000
S-10896	13 x 14"	12	53	49	46	44	1,000
S-3644	13 x 16"	14	56	52	48	46	1,000
S-10897	13 x 20"	17	62	60	57	53	1,000
S-5398	14 x 14"	13	59	57	54	49	1,000
S-5789	14 x 16"	15	67	64	61	57	1,000
S-3991	14 x 18"	17	71	67	64	61	1,000
S-3453	14 x 20"	19	79	72	68	65	1,000
S-14423	14 x 22"	21	86	82	79	71	1,000
S-6311	14 x 24"	23	93	87	83	80	1,000
S-10898	14 x 30"	28	117	111	104	98	1,000
S-10899	15 x 15"	15	68	65	62	58	1,000

MODEL NO.	OUTSIDE W x L	LBS./ CTN.	PRICE PER CARTON				QTY./ CTN.
			1	5	10	20+	
S-5399	15 x 18"	18	\$82	\$79	\$72	\$68	1,000
S-6312	15 x 20"	20	88	84	80	74	1,000
S-10900	15 x 24"	24	97	91	86	82	1,000
S-10901	16 x 16"	17	84	81	78	70	1,000
S-10902	16 x 18"	19	87	83	80	72	1,000
S-5790	16 x 20"	22	90	86	82	79	1,000
S-6313	16 x 24"	26	97	91	86	82	1,000
S-10903	16 x 30"	32	110	104	98	91	1,000
S-10904	16 x 40"	21	72	69	65	62	500
S-5791	18 x 18"	22	93	87	83	80	1,000
S-6314	18 x 20"	24	97	91	86	82	1,000
<b>S-3205</b>	<b>18 x 24"</b>	<b>29</b>	<b>\$87 per carton any quantity</b>				<b>1,000</b>
S-18668	18 x 26"	31	113	107	102	97	1,000
S-10905	18 x 30"	36	120	114	107	102	1,000
S-15072	18 x 36"	43	162	153	145	135	1,000
S-6315	20 x 20"	14	51	48	45	43	500
S-6316	20 x 24"	16	60	57	54	49	500
S-6317	20 x 30"	20	88	84	80	74	500
S-10906	20 x 36"	24	108	103	97	90	500
S-10907	20 x 42"	28	120	114	107	102	500
S-10908	20 x 48"	32	140	133	125	118	500
S-17558	22 x 22"	16	80	78	71	67	500
S-6318	24 x 24"	20	86	82	79	71	500
S-6319	24 x 30"	24	108	103	97	90	500
S-13460	24 x 32"	27	111	105	100	93	500
S-5400	24 x 36"	29	124	117	111	104	500
S-10909	24 x 42"	34	147	138	131	123	500
S-10910	26 x 26"	23	98	93	87	83	500
S-10911	26 x 30"	26	112	106	102	95	500
S-10912	26 x 36"	31	137	129	122	114	500
S-10913	26 x 42"	36	155	147	139	131	500
S-10914	28 x 36"	34	147	138	131	123	500
S-10915	30 x 30"	30	130	123	116	108	500
S-10916	30 x 36"	36	154	147	138	130	500
S-10917	30 x 42"	21	89	85	81	78	250
S-10918	30 x 48"	24	105	100	95	88	250
S-10919	36 x 36"	22	90	86	82	79	250
S-10920	36 x 42"	25	110	104	98	91	250
S-10921	36 x 48"	29	124	117	111	104	250
S-12289	40 x 48"	33	140	133	125	118	250
S-10922	44 x 48"	35	152	145	135	128	250
S-10923	48 x 48"	39	164	155	147	138	250



MODEL NO.	OUTSIDE W x L	LBS./ CTN.	PRICE PER CARTON				QTY./ CTN.
			1	5	10	20+	
S-15165	1 x 2"	1	\$4	\$4	\$3	\$3	1,000
S-2913	2 x 2"	1	9	9	8	8	1,000
S-940	2 x 3"	1	11	11	10	10	1,000
S-1001	2 x 4"	2	15	14	14	13	1,000
S-2914	2 x 5"	2	16	15	15	14	1,000
S-1993	2 x 6"	2	17	17	16	15	1,000
S-1330	2 x 7"	2	20	19	18	17	1,000
S-1994	2 x 8"	2	21	20	19	18	1,000
S-6320	2 x 9"	3	25	23	22	21	1,000
S-2379	2 x 10"	3	26	25	23	22	1,000
S-1425	2 x 12"	3	34	30	29	27	1,000
S-6321	2 x 14"	4	30	28	27	25	1,000
S-2915	2 x 16"	4	38	35	35	32	1,000
S-1426	2 x 18"	4	41	39	37	35	1,000
S-6322	2 x 20"	6	45	43	40	38	1,000
S-1427	2 x 24"	6	51	49	46	44	1,000
S-7255	2 x 26"	7	54	51	48	46	1,000
S-3588	2 x 28"	8	65	62	57	54	1,000
S-941	3 x 3"	2	15	14	14	13	1,000
S-942	3 x 4"	2	16	15	15	14	1,000
<b>S-943</b>	<b>3 x 5"</b>	<b>2</b>	<b>\$15 per carton any quantity</b>				<b>1,000</b>
S-944	3 x 6"	2	21	20	19	18	1,000
S-3975	3 x 7"	3	22	21	20	19	1,000
S-1331	3 x 8"	3	25	23	22	21	1,000
S-5763	3 x 9"	4	26	25	23	22	1,000
S-1428	3 x 10"	4	27	26	24	23	1,000
S-1429	3 x 12"	4	34	30	29	27	1,000
S-3068	3 x 14"	7	37	35	34	30	1,000
S-3069	3 x 16"	8	39	38	35	34	1,000
S-1430	3 x 18"	8	45	43	40	38	1,000
S-2916	3 x 20"	8	49	46	44	41	1,000
S-1431	3 x 24"	9	57	53	50	47	1,000
S-6323	3 x 26"	11	52	50	48	45	1,000
S-6324	3 x 28"	12	62	58	56	51	1,000
S-5764	3 x 30"	12	61	58	54	52	1,000
S-15166	3 x 36"	14	73	69	66	62	1,000
S-15167	3½ x 5"	2	20	19	18	17	1,000
S-945	4 x 4"	2	16	15	15	14	1,000
S-946	4 x 5"	3	20	19	18	17	1,000
<b>S-947</b>	<b>4 x 6"</b>	<b>3</b>	<b>\$18 per carton any quantity</b>				<b>1,000</b>

SOLD IN CARTON QUANTITIES

MODEL NO.	OUTSIDE W x L	LBS./ CTN.	PRICE PER CARTON				QTY./ CTN.
			1	5	10	20+	
S-2380	4 x 7"	4	\$22	\$21	\$20	\$19	1,000
S-1332	4 x 8"	4	25	23	22	21	1,000
S-3589	4 x 9"	5	28	27	24	23	1,000
S-1333	4 x 10"	5	30	29	27	26	1,000
S-1003	4 x 12"	7	35	34	32	29	1,000
S-3070	4 x 14"	8	39	38	35	34	1,000
S-22709	4 x 15"	8	43	40	38	36	1,000
S-1432	4 x 16"	9	45	43	40	38	1,000
S-2917	4 x 18"	10	49	46	44	41	1,000
S-1433	4 x 20"	11	53	50	47	45	1,000
S-3071	4 x 24"	14	65	62	57	54	1,000
S-6325	4 x 28"	15	72	69	65	61	1,000
S-6326	4 x 30"	16	75	71	67	64	1,000
S-6327	4 x 36"	20	80	74	71	67	1,000
S-17544	4 x 40"	21	95	89	86	81	1,000
S-17545	4 x 52"	28	122	116	112	105	1,000
S-2381	5 x 5"	3	22	21	20	19	1,000
S-1726	5 x 6"	4	25	23	22	21	1,000
S-948	5 x 7"	4	25	23	22	21	1,000
S-949	5 x 8"	5	26	25	23	22	1,000
S-2382	5 x 9"	6	27	26	24	23	1,000
S-950	5 x 10"	7	30	29	27	26	1,000
S-1334	5 x 12"	8	37	35	34	30	1,000
S-2383	5 x 14"	9	39	38	35	34	1,000
S-3072	5 x 15"	10	45	43	40	38	1,000
S-3073	5 x 16"	11	53	50	47	45	1,000
S-6328	5 x 18"	12	58	56	53	49	1,000
S-3074	5 x 20"	15	67	64	60	57	1,000
S-3075	5 x 24"	17	75	71	67	64	1,000
S-3076	5 x 28"	18	82	79	74	69	1,000
S-1435	5 x 30"	19	88	83	80	74	1,000
S-6329	5 x 38"	26	103	98	93	87	1,000
S-951	6 x 6"	5	25	23	22	21	1,000
S-3077	6 x 7"	6	26	25	23	22	1,000
<b>S-952</b>	<b>6 x 8"</b>	<b>7</b>	<b>\$23 per carton any quantity</b>				<b>1,000</b>
S-953	6 x 9"	8	34	30	29	27	1,000
S-954	6 x 10"	9	35	34	32	29	1,000
S-1004	6 x 12"	11	38	35	35	32	1,000
S-1995	6 x 14"	12	44	41	39	37	1,000
S-3078	6 x 15"	13	49	46	44	41	1,000





**OVER 300 SIZES  
IN STOCK**

**SOLD IN CARTON QUANTITIES**

MODEL NO.	OUTSIDE W x L	LBS./ CTN.	PRICE PER CARTON				QTY./ CTN.
			1	5	10	20+	
S-1436	6 x 16"	14	\$50	\$48	\$45	\$43	1,000
S-3079	6 x 18"	16	53	50	47	45	1,000
S-1437	6 x 20"	18	57	53	50	47	1,000
S-1438	6 x 24"	20	80	75	71	67	1,000
S-3080	6 x 28"	23	90	86	81	78	1,000
S-1439	6 x 30"	25	98	93	87	82	1,000
S-3590	6 x 36"	29	118	112	104	100	1,000
S-5765	6 x 40"	34	131	124	118	111	1,000
S-3081	7 x 7"	7	28	27	24	23	1,000
S-1727	7 x 8"	7	35	34	32	29	1,000
S-1005	7 x 9"	9	38	35	35	32	1,000
S-1006	7 x 10"	10	39	38	35	34	1,000
S-5766	7 x 11"	11	41	39	37	35	1,000
S-1335	7 x 12"	11	45	43	40	38	1,000
S-5767	7 x 13"	13	49	46	44	41	1,000
S-1336	7 x 14"	13	50	48	45	43	1,000
S-3082	7 x 15"	15	54	51	48	46	1,000
S-2384	7 x 16"	16	57	54	51	48	1,000
S-3083	7 x 18"	18	68	65	62	57	1,000
S-3084	7 x 20"	20	75	71	67	64	1,000
S-15168	7 x 22"	21	82	79	74	69	1,000
S-2918	7 x 24"	23	87	82	79	72	1,000
S-3085	7 x 28"	27	102	96	90	84	1,000
S-2919	7 x 30"	28	117	111	103	98	1,000
S-1337	8 x 8"	8	37	35	34	31	1,000
S-15169	8 x 9"	9	39	38	35	34	1,000
S-955	8 x 10"	10	\$34 per carton any quantity				1,000
S-3591	8 x 11"	12	47	45	43	40	1,000
S-1007	8 x 12"	13	50	48	45	43	1,000
S-5769	8 x 13"	14	53	50	47	45	1,000
S-1440	8 x 14"	15	57	54	51	48	1,000
S-2971	8 x 15"	16	58	56	53	49	1,000
S-1441	8 x 16"	17	65	62	57	54	1,000
S-1996	8 x 18"	18	72	69	65	61	1,000
S-1442	8 x 20"	22	89	84	80	75	1,000
S-1443	8 x 24"	26	102	96	90	84	1,000
S-3086	8 x 28"	30	116	107	102	97	1,000
S-1728	8 x 30"	32	126	122	114	106	1,000
S-3087	8 x 36"	40	146	137	129	122	1,000
S-3088	8 x 40"	44	161	151	142	133	1,000

MODEL NO.	OUTSIDE W x L	LBS./ CTN.	PRICE PER CARTON				QTY./ CTN.
			1	5	10	20+	
S-15170	8 x 48"	51	\$189	\$177	\$169	\$156	1,000
S-3089	9 x 9"	11	45	43	40	38	1,000
S-1444	9 x 10"	12	49	46	44	41	1,000
S-5772	9 x 11"	13	51	49	46	44	1,000
S-956	9 x 12"	14	\$44 per carton any quantity				1,000
S-5773	9 x 13"	15	54	51	48	46	1,000
S-1338	9 x 14"	16	58	56	53	49	1,000
S-3090	9 x 15"	18	67	64	60	57	1,000
S-1445	9 x 16"	19	71	67	64	60	1,000
S-16409	9 x 17"	21	80	74	70	66	1,000
S-1339	9 x 18"	23	83	80	75	70	1,000
S-3091	9 x 20"	26	87	82	79	72	1,000
S-1997	9 x 24"	29	101	95	89	83	1,000
S-3092	9 x 28"	35	118	112	104	100	1,000
S-13469	9 x 36"	43	149	142	133	125	1,000
S-1446	10 x 10"	13	51	49	46	44	1,000
S-5775	10 x 11"	15	54	51	48	46	1,000
S-1340	10 x 12"	16	\$48 per carton any quantity				1,000
S-3478	10 x 13"	17	65	62	57	54	1,000
S-1008	10 x 14"	19	71	67	64	60	1,000
S-1729	10 x 15"	20	74	70	66	63	1,000
S-1009	10 x 16"	22	81	78	72	68	1,000
S-5776	10 x 17"	24	83	80	75	70	1,000
S-1341	10 x 18"	26	87	82	79	72	1,000
S-1342	10 x 20"	28	98	93	87	82	1,000
S-5777	10 x 22"	31	102	97	91	86	1,000
S-1343	10 x 24"	34	113	106	102	96	1,000
S-3093	10 x 28"	39	141	133	125	119	1,000
S-1447	10 x 30"	40	147	139	131	124	1,000
S-3094	10 x 36"	50	175	168	156	148	1,000
S-16410	10 x 40"	27	101	95	89	83	500
S-16411	10 x 42"	28	105	102	96	89	500
S-17676	10 x 48"	32	120	114	106	102	500
S-22707	11 x 11"	16	63	60	54	51	1,000
S-3095	11 x 12"	19	65	62	57	54	1,000
S-22708	11 x 13"	20	70	67	63	60	1,000
S-3096	11 x 14"	22	78	72	68	65	1,000
S-13470	11 x 15"	23	82	79	74	69	1,000
S-3097	11 x 16"	25	86	81	78	71	1,000
S-1730	11 x 18"	27	93	87	82	79	1,000



SOLD IN CARTON QUANTITIES

MODEL NO.	OUTSIDE W x L	LBS./ CTN.	PRICE PER CARTON				QTY./ CTN.
			1	5	10	20+	
S-15171	11 x 20"	30	\$103	\$98	\$93	\$87	1,000
S-3098	11 x 24"	37	124	117	111	103	1,000
S-3592	12 x 10"	16	58	56	53	49	1,000
S-1344	12 x 12"	20	67	64	60	57	1,000
S-13471	12 x 13"	21	72	69	65	61	1,000
S-1345	12 x 14"	23	75	71	67	64	1,000
<b>S-2385</b>	<b>12 x 15"</b>	<b>25</b>	<b>\$68 per carton any quantity</b>				<b>1,000</b>
S-1346	12 x 16"	26	87	82	79	72	1,000
<b>S-1010</b>	<b>12 x 18"</b>	<b>30</b>	<b>\$82 per carton any quantity</b>				<b>1,000</b>
S-1347	12 x 20"	32	108	103	98	91	1,000
S-5778	12 x 22"	36	119	113	105	101	1,000
S-1348	12 x 24"	40	129	123	116	107	1,000
S-5779	12 x 26"	42	141	133	125	119	1,000
S-1449	12 x 30"	48	159	149	141	132	1,000
S-1731	12 x 36"	30	102	97	91	86	500
S-3593	12 x 48"	40	147	139	131	124	500
S-3099	13 x 13"	24	75	71	67	64	1,000
S-3100	13 x 14"	26	82	79	74	69	1,000
S-1732	13 x 16"	29	93	87	82	79	1,000
S-15172	13 x 17"	30	101	95	89	83	1,000
S-3594	13 x 18"	32	103	98	93	87	1,000
S-3101	13 x 20"	36	118	112	104	100	1,000
S-3102	13 x 24"	43	141	133	125	119	1,000
S-3103	13 x 28"	50	162	152	145	135	1,000
S-1450	14 x 14"	27	88	83	80	74	1,000
S-1349	14 x 16"	30	102	96	90	84	1,000
S-1350	14 x 18"	34	113	106	102	96	1,000
S-1351	14 x 20"	38	124	118	112	104	1,000
S-5780	14 x 22"	41	140	132	124	118	1,000
S-1451	14 x 24"	45	149	142	133	125	1,000
S-17677	14 x 26"	48	159	149	141	132	1,000
S-5781	14 x 28"	52	168	156	149	140	1,000
S-1733	14 x 30"	29	93	87	82	79	500
S-1734	14 x 36"	34	117	111	103	98	500
S-3104	14 x 40"	39	124	118	112	104	500
S-3105	15 x 15"	32	102	96	90	84	1,000
S-1735	15 x 18"	37	120	114	106	102	1,000
S-2454	15 x 20"	40	134	126	120	113	1,000
S-3106	15 x 24"	26	83	80	75	70	500
S-2920	15 x 30"	30	98	93	87	82	500

MODEL NO.	OUTSIDE W x L	LBS./ CTN.	PRICE PER CARTON				QTY./ CTN.
			1	5	10	20+	
S-2921	15 x 36"	36	\$120	\$114	\$106	\$102	500
S-1452	16 x 16"	34	117	111	103	98	1,000
S-1453	16 x 18"	39	129	123	116	107	1,000
S-1352	16 x 20"	43	146	137	129	122	1,000
S-6330	16 x 22"	47	154	147	139	130	1,000
S-1353	16 x 24"	53	164	154	147	138	1,000
S-5782	16 x 26"	56	175	168	156	148	1,000
S-3107	16 x 28"	31	98	93	87	82	500
S-1736	16 x 30"	32	103	98	93	87	500
S-1737	16 x 36"	39	124	118	112	104	500
S-16412	16 x 48"	26	75	71	67	64	250
S-1354	18 x 18"	44	147	138	130	123	1,000
S-2455	18 x 20"	48	159	149	141	132	1,000
S-14421	18 x 22"	27	87	82	79	72	500
<b>S-1011</b>	<b>18 x 24"</b>	<b>29</b>	<b>\$79 per carton any quantity</b>				<b>500</b>
S-5783	18 x 26"	32	102	96	90	84	500
S-1738	18 x 30"	36	118	112	104	100	500
S-1739	18 x 36"	43	141	133	125	119	500
S-1740	18 x 42"	50	162	152	145	135	500
S-1741	18 x 48"	39	93	87	82	79	250
S-1742	20 x 20"	27	87	82	79	72	500
S-16413	20 x 22"	30	97	91	86	81	500
S-1454	20 x 24"	32	103	98	93	87	500
S-6487	20 x 26"	35	113	106	102	96	500
S-13472	20 x 28"	37	123	116	108	102	500
S-1743	20 x 30"	40	129	123	116	107	500
S-5784	20 x 32"	43	140	132	124	118	500
S-13473	20 x 34"	46	147	139	131	124	500
S-1744	20 x 36"	48	153	147	138	129	500
S-22700	20 x 40"	27	87	83	78	72	250
S-1745	20 x 42"	28	90	86	81	78	250
S-1746	20 x 48"	32	103	98	93	87	250
S-12305	22 x 22"	32	103	98	93	87	500
S-2922	22 x 24"	35	117	111	103	98	500
S-16414	22 x 26"	38	125	119	113	105	500
S-3108	22 x 30"	44	146	137	129	122	500
S-3109	22 x 36"	26	87	82	79	72	250
S-6331	22 x 40"	30	95	89	83	80	250
S-1747	24 x 24"	40	124	118	112	104	500
S-3110	24 x 26"	43	134	126	120	113	500

MODEL NO.	OUTSIDE W x L	LBS./ CTN.	PRICE PER CARTON				QTY./ CTN.
			1	5	10	20+	
S-1356	24 x 30"	49	\$153	\$147	\$138	\$129	500
S-12306	24 x 32"	28	83	80	75	70	250
S-1357	24 x 36"	30	93	87	82	79	250
S-3111	24 x 38"	32	101	95	89	83	250
S-22704	24 x 40"	33	106	100	95	88	250
S-1748	24 x 42"	34	111	104	100	93	250
S-1749	24 x 48"	39	124	118	112	104	250
S-13474	24 x 54"	44	141	133	125	119	250
S-1750	24 x 60"	48	153	147	138	129	250
S-3112	26 x 26"	47	147	139	131	124	500
S-3113	26 x 30"	27	86	81	78	71	250
S-17678	26 x 32"	28	89	84	80	75	250
S-3114	26 x 36"	33	102	96	90	84	250
S-6332	26 x 40"	35	113	106	102	96	250
S-10924	26 x 42"	36	119	113	105	101	250
S-6333	26 x 48"	42	134	126	120	113	250
S-10925	28 x 28"	26	86	81	78	71	250
S-17679	28 x 30"	28	93	87	82	79	250
S-3115	28 x 32"	31	98	93	87	82	250
S-6334	28 x 34"	32	102	97	91	86	250
S-3595	28 x 36"	35	111	104	100	93	250
S-10926	28 x 40"	37	123	116	108	102	250
S-6335	28 x 46"	43	141	133	125	119	250
S-10927	28 x 48"	36	118	112	104	100	200
S-15173	28 x 50"	39	123	116	108	102	200
S-10928	28 x 60"	22	72	69	65	61	100
S-1751	30 x 30"	31	98	93	87	82	250
S-1752	30 x 36"	37	118	112	104	100	250
S-3411	30 x 40"	41	129	123	116	107	250
S-1753	30 x 42"	43	137	128	122	114	250
S-17680	30 x 44"	44	141	133	125	119	250
S-1754	30 x 48"	49	153	147	138	129	250
S-1755	30 x 60"	49	153	147	138	129	200
S-3116	32 x 32"	36	112	105	101	95	250
S-10935	32 x 40"	34	112	105	101	95	200
S-3596	32 x 42"	36	118	112	104	100	200
S-10929	32 x 44"	38	123	116	108	102	200
S-3597	32 x 48"	42	132	125	119	112	200
S-22705	32 x 50"	44	139	132	126	118	200
S-10930	32 x 56"	24	80	74	70	66	100



S-12308

SOLD IN CARTON QUANTITIES

MODEL NO.	OUTSIDE W x L	LBS./ CTN.	PRICE PER CARTON				QTY./ CTN.
			1	5	10	20+	
S-3976	34 x 36"	42	\$132	\$125	\$119	\$112	250
S-10931	34 x 40"	36	119	113	105	101	200
S-3977	34 x 48"	45	142	135	126	120	200
S-1756	36 x 36"	44	141	133	125	119	250
S-6688	36 x 40"	48	153	147	138	129	250
S-1757	36 x 42"	40	130	124	117	108	200
S-1358	36 x 48"	46	149	142	133	125	200
S-13475	36 x 54"	27	86	81	78	71	100
S-1759	36 x 60"	30	93	87	82	79	100
S-15174	38 x 38"	39	124	118	112	104	200
S-3978	38 x 42"	42	140	132	124	118	200
S-3598	38 x 48"	49	154	147	139	130	200
S-12307	38 x 60"	32	101	95	89	83	100
S-6488	38 x 64"	34	105	102	96	89	100
S-6336	40 x 40"	43	140	132	124	118	200
S-1760	40 x 42"	44	147	138	130	123	200
S-1359	40 x 48"	26	83	80	75	70	100
S-1762	40 x 54"	29	93	87	82	79	100
S-1763	40 x 60"	32	103	98	93	87	100
S-3117	44 x 48"	30	90	86	81	78	100
S-10932	44 x 60"	35	117	111	103	98	100
S-1764	48 x 48"	31	102	96	90	84	100
S-1765	48 x 54"	35	113	106	102	96	100
S-1455	48 x 60"	39	124	118	112	104	100
S-10933	52 x 60"	21	68	65	62	57	50
S-10934	56 x 60"	22	82	79	74	69	50
S-12308	60 x 60"	25	93	87	82	79	50



- Protects and keeps direct mail pieces visible.
- High clarity film. Low density, virgin resin.
  - Approved for use with automation machines.

## POSTAL APPROVED BAGS



### OPEN END BAGS

MODEL NO.	SIZE W x L	MIL	PRICE PER CARTON			QTY./ CTN.
			1	3	5+	
S-10405	9 x 12"	2	\$67	\$63	\$58	1,000
S-10406	10 x 13"		78	71	67	

### SELF-SEAL BAGS

S-12511	6 x 9"	2	\$76	\$70	\$65	1,000
S-13528	7½ x 10½"		99	93	86	
S-10846	9 x 12"		116	108	100	
S-11149	10 x 13"		130	123	113	
S-12512	12 x 15½"	2	85	80	74	500



# ULINE 3 MIL INDUSTRIAL POLY BAGS

OVER 160 STOCK SIZES



3 MIL ADDED PROTECTION FOR PARTS AND HARDWARE



SOLD IN CARTON QUANTITIES

MODEL NO.	OUTSIDE W x L	LBS./ CTN.	PRICE PER CARTON				QTY./ CTN.
			1	5	10	20+	
S-5373	2 x 3"	2	\$15	\$14	\$14	\$13	1,000
S-10936	2 x 4"	2	16	15	15	14	1,000
S-10937	2 x 6"	2	20	19	18	17	1,000
S-10938	2 x 8"	3	22	21	20	19	1,000
S-15113	2 x 10"	4	28	27	25	23	1,000
S-5374	3 x 3"	2	16	15	15	14	1,000
S-5375	3 x 4"	3	20	19	18	17	1,000
S-3992	3 x 5"	3	21	20	19	18	1,000
S-5792	3 x 6"	3	26	23	22	21	1,000
S-5376	3 x 8"	4	28	27	25	23	1,000
S-10939	3 x 10"	6	35	34	32	29	1,000
S-10940	3 x 12"	7	38	36	35	34	1,000
S-10941	3 x 16"	10	45	43	40	38	1,000
S-10942	3 x 24"	14	62	60	57	53	1,000
S-5377	4 x 4"	3	22	21	20	19	1,000
S-3454	4 x 5"	4	26	23	22	21	1,000
S-2951	4 x 6"	4	\$23 per carton any quantity				1,000
S-10943	4 x 7"	6	35	34	32	29	1,000
S-3993	4 x 8"	6	36	35	34	30	1,000
S-5378	4 x 10"	7	39	38	36	35	1,000
S-5379	4 x 12"	9	45	43	40	38	1,000
S-10944	4 x 14"	11	49	46	44	41	1,000
S-10945	4 x 16"	13	53	49	46	44	1,000
S-10946	4 x 20"	16	65	62	58	56	1,000
S-10947	5 x 5"	5	32	30	28	27	1,000
S-5380	5 x 6"	6	35	34	32	29	1,000
S-2952	5 x 7"	6	37	35	35	32	1,000
S-3645	5 x 8"	7	39	38	36	35	1,000
S-10948	5 x 9"	9	44	41	39	37	1,000
S-5381	5 x 10"	9	47	45	43	40	1,000
S-5793	5 x 12"	11	57	54	51	47	1,000
S-10949	5 x 14"	14	62	60	57	53	1,000
S-10950	5 x 16"	16	71	67	64	61	1,000
S-10951	6 x 6"	7	39	38	36	35	1,000
S-10952	6 x 7"	8	41	39	37	35	1,000
S-2953	6 x 8"	9	\$37 per carton any quantity				1,000
S-3646	6 x 9"	10	47	45	43	40	1,000

MODEL NO.	OUTSIDE W x L	LBS./ CTN.	PRICE PER CARTON				QTY./ CTN.
			1	5	10	20+	
S-3647	6 x 10"	11	\$54	\$51	\$47	\$45	1,000
S-3648	6 x 12"	14	65	62	58	56	1,000
S-10953	6 x 14"	17	71	67	64	61	1,000
S-10954	6 x 16"	19	74	70	66	63	1,000
S-10955	6 x 18"	22	81	78	71	67	1,000
S-10956	6 x 24"	29	102	95	89	84	1,000
S-10957	6 x 30"	36	120	114	107	102	1,000
S-10958	7 x 7"	10	53	49	46	44	1,000
S-10959	7 x 8"	11	54	51	47	45	1,000
S-3455	7 x 9"	12	56	53	48	46	1,000
S-3649	7 x 10"	13	62	60	57	53	1,000
S-5382	7 x 12"	16	71	67	64	61	1,000
S-10960	7 x 14"	20	81	78	71	67	1,000
S-10961	7 x 16"	22	87	83	80	72	1,000
S-5383	8 x 8"	12	57	54	51	47	1,000
S-3206	8 x 10"	15	71	67	64	61	1,000
S-3456	8 x 12"	18	79	72	68	65	1,000
S-10962	8 x 14"	22	87	83	80	72	1,000
S-16430	8 x 15"	23	93	87	83	80	1,000
S-5794	8 x 16"	24	102	95	89	84	1,000
S-10963	8 x 18"	29	110	104	98	91	1,000
S-10964	8 x 20"	32	119	113	106	102	1,000
S-10965	8 x 24"	38	142	135	128	120	1,000
S-10966	9 x 9"	16	79	72	68	65	1,000
S-10967	9 x 10"	18	81	78	71	67	1,000
S-2954	9 x 12"	22	83	80	74	69	1,000
S-10968	9 x 13"	24	84	81	78	70	1,000
S-5384	9 x 14"	26	87	83	80	72	1,000
S-10969	9 x 16"	29	102	96	90	85	1,000
S-10970	9 x 24"	22	72	69	65	62	500
S-10971	9 x 30"	27	88	84	80	74	500
S-10972	10 x 10"	20	83	80	74	69	1,000
S-2955	10 x 12"	24	88	84	80	74	1,000
S-10973	10 x 13"	26	102	96	90	85	1,000
S-3650	10 x 14"	28	105	100	95	88	1,000
S-10974	10 x 15"	30	112	106	102	95	1,000
S-3994	10 x 16"	32	118	112	105	100	1,000

MODEL NO.	OUTSIDE W x L	LBS./ CTN.	PRICE PER CARTON				QTY./ CTN.
			1	5	10	20+	
S-10975	10 x 18"	36	\$137	\$129	\$122	\$114	1,000
S-10976	10 x 20"	40	153	146	137	129	1,000
S-6689	10 x 24"	48	167	156	149	139	1,000
S-15114	10 x 30"	30	111	105	100	93	500
S-10977	10 x 36"	36	124	117	111	104	500
S-6337	11 x 14"	31	116	108	103	97	1,000
S-15115	11 x 16"	35	130	123	116	108	1,000
S-15116	11 x 20"	44	161	152	142	134	1,000
S-16431	11 x 24"	49	191	181	170	161	1,000
S-5385	12 x 12"	29	103	97	91	86	1,000
S-10978	12 x 14"	34	120	114	107	102	1,000
S-10979	12 x 15"	36	132	125	118	111	1,000
S-3651	12 x 16"	39	138	131	123	116	1,000
S-3208	12 x 18"	44	154	147	138	130	1,000
S-5795	12 x 20"	48	173	164	154	146	1,000
S-3457	12 x 24"	26	98	93	87	83	500
S-12309	12 x 30"	30	118	112	105	100	500
S-10980	12 x 36"	22	72	69	65	62	250
S-16432	13 x 14"	36	131	124	117	110	1,000
S-16433	13 x 20"	26	93	87	83	80	500
S-10981	14 x 14"	39	156	149	140	132	1,000
S-10982	14 x 16"	44	163	154	146	137	1,000
S-3995	14 x 18"	50	168	158	150	140	1,000
S-10983	14 x 20"	28	95	89	84	80	500
S-6489	14 x 24"	34	111	105	100	93	500
S-10984	14 x 30"	21	69	66	63	60	250
S-15117	15 x 18"	27	93	87	83	80	500
S-10985	15 x 20"	30	105	100	95	88	500
S-15118	15 x 24"	36	124	117	111	104	500
S-10986	15 x 30"	23	82	79	72	68	250
S-10987	15 x 36"	27	98	93	87	83	250
S-10988	16 x 16"	26	93	87	83	80	500
S-10989	16 x 18"	29	103	97	91	86	500
S-5796	16 x 20"	32	111	105	100	93	500
S-5386	16 x 24"	39	125	118	112	105	500
S-16434	16 x 28"	23	80	74	70	66	250
S-10991	16 x 30"	24	88	84	80	74	250
S-10992	16 x 36"	29	108	103	97	90	250
S-10993	18 x 18"	32	116	108	103	97	500
S-10994	18 x 20"	36	130	123	116	108	500
S-3209	18 x 24"	44	141	134	126	119	500
S-10995	18 x 30"	27	93	87	83	80	250
S-10996	18 x 36"	32	117	111	104	98	250
S-16435	18 x 42"	38	137	129	122	114	250
S-10997	20 x 20"	40	149	140	133	125	500
S-10998	20 x 24"	24	84	81	78	70	250
S-5797	20 x 30"	30	97	91	86	82	250
S-15119	20 x 36"	36	132	125	118	111	250
S-16436	20 x 42"	42	155	147	139	131	250
S-15120	22 x 30"	33	120	114	107	102	250
S-15121	22 x 36"	40	147	138	131	123	250



MODEL NO.	OUTSIDE W x L	LBS./ CTN.	PRICE PER CARTON				QTY./ CTN.
			1	5	10	20+	
S-10999	24 x 24"	29	\$105	\$100	\$95	\$88	250
S-11000	24 x 26"	31	110	104	98	91	250
S-5798	24 x 30"	36	118	112	105	100	250
S-6490	24 x 36"	43	141	134	126	119	250
S-11002	24 x 38"	37	124	117	111	104	200
S-15122	24 x 42"	40	150	142	134	126	200
S-11003	24 x 48"	23	86	82	79	71	100
S-11004	26 x 26"	34	131	124	117	110	250
S-15123	26 x 30"	39	141	134	126	119	250
S-15124	26 x 36"	47	169	159	151	141	250
S-12310	28 x 32"	37	134	128	120	113	200
S-16437	28 x 36"	40	152	145	135	128	200
S-15125	28 x 40"	22	82	79	72	68	100
S-11005	30 x 30"	36	137	129	122	114	200
S-11006	30 x 36"	22	81	78	71	67	100
S-16438	30 x 40"	24	87	83	80	72	100
S-15126	30 x 42"	27	90	86	82	79	100
S-15127	30 x 48"	29	105	100	95	88	100
S-16439	32 x 32"	20	78	71	67	64	100
S-15128	32 x 40"	26	93	87	83	80	100
S-16440	32 x 44"	29	105	100	95	88	100
S-16441	32 x 56"	35	132	125	118	111	100
S-16442	34 x 40"	27	102	95	89	84	100
S-16443	34 x 60"	40	149	140	133	125	100
S-11007	36 x 36"	26	90	86	82	79	100
S-11008	36 x 42"	30	112	106	102	95	100
S-11009	36 x 48"	35	125	118	112	105	100
S-11010	36 x 60"	22	81	78	71	67	50
S-16444	38 x 42"	31	117	111	104	98	100
S-12311	38 x 64"	26	90	86	82	79	50
S-11011	40 x 42"	34	120	114	107	102	100
S-15129	40 x 48"	38	141	134	126	119	100
S-16445	40 x 54"	43	161	152	142	134	100
S-16446	40 x 60"	25	88	84	80	74	50
S-16447	44 x 60"	27	98	93	87	83	50
S-16448	48 x 48"	46	169	159	151	141	100
S-16449	48 x 54"	26	93	87	83	80	50
S-15131	48 x 60"	29	105	100	95	88	50
S-16450	52 x 60"	31	111	105	100	93	50
S-11012	56 x 60"	34	120	114	107	102	50

- Excellent for heavier items.
- Meets FDA and USDA specifications.
- Virgin polyethylene film.

COMBINE SIZES FOR VOLUME DISCOUNT



SOLD IN CARTON QUANTITIES

MODEL NO.	OUTSIDE W x L	LBS./ CTN.	PRICE PER CARTON				QTY./ CTN.
			1	5	10	20+	
S-1581	2 x 3"	2	\$17	\$17	\$16	\$15	1,000
S-1772	2 x 4"	3	21	20	19	18	1,000
S-2923	2 x 5"	3	25	23	22	21	1,000
S-2118	2 x 6"	3	26	25	23	22	1,000
S-1773	2 x 7"	4	27	26	24	23	1,000
S-2119	2 x 8"	4	34	30	29	27	1,000
S-16400	2 x 9"	5	37	35	34	30	1,000
S-1774	2 x 10"	5	38	35	35	32	1,000
S-1775	2 x 12"	6	44	41	39	37	1,000
S-6340	2 x 16"	9	51	49	46	44	1,000
S-1776	2 x 18"	11	57	53	50	47	1,000
S-3135	2 x 24"	12	81	78	72	68	1,000
S-1778	3 x 3"	3	21	20	19	18	1,000
S-1582	3 x 4"	4	25	23	22	21	1,000
S-1368	3 x 5"	4	27	26	24	23	1,000
S-1507	3 x 6"	5	34	30	29	27	1,000
S-6341	3 x 7"	6	35	34	32	29	1,000
S-1583	3 x 8"	6	37	35	34	30	1,000
S-6342	3 x 9"	8	39	38	35	34	1,000
S-1779	3 x 10"	8	44	41	39	37	1,000
S-2618	3 x 12"	9	50	48	45	43	1,000
S-2120	3 x 14"	10	57	53	50	47	1,000
S-2121	3 x 16"	12	68	65	62	57	1,000
S-1781	3 x 18"	13	78	72	68	65	1,000
S-3136	3 x 24"	18	102	96	90	84	1,000
S-6343	3 x 26"	21	108	103	98	91	1,000
S-6344	3 x 30"	24	124	117	111	103	1,000
S-17681	3 x 36"	29	146	137	129	122	1,000
S-1783	4 x 4"	4	26	25	23	22	1,000
S-1508	4 x 5"	5	27	26	24	23	1,000
S-1369	4 x 6"	6	\$27 per carton any quantity				1,000
S-3137	4 x 7"	7	39	38	35	34	1,000
S-1509	4 x 8"	10	41	39	37	35	1,000
S-1784	4 x 10"	12	49	46	44	41	1,000
S-1510	4 x 12"	14	54	51	48	46	1,000
S-2619	4 x 15"	15	72	69	65	61	1,000
S-1785	4 x 16"	16	80	75	71	67	1,000
S-3138	4 x 18"	17	86	81	78	71	1,000
S-1786	4 x 20"	21	98	93	87	82	1,000
S-1787	4 x 24"	26	111	104	100	93	1,000

MODEL NO.	OUTSIDE W x L	LBS./ CTN.	PRICE PER CARTON				QTY./ CTN.
			1	5	10	20+	
S-3599	4 x 36"	39	\$162	\$152	\$145	\$135	1,000
S-2122	5 x 5"	6	38	35	35	32	1,000
S-2123	5 x 6"	7	41	39	37	35	1,000
S-1370	5 x 7"	9	44	41	39	37	1,000
S-1584	5 x 8"	11	47	45	43	40	1,000
S-2363	5 x 9"	12	51	49	46	44	1,000
S-1371	5 x 10"	13	57	53	50	47	1,000
S-1788	5 x 12"	16	67	64	60	57	1,000
S-3139	5 x 14"	19	80	75	71	67	1,000
S-2620	5 x 15"	21	81	78	72	68	1,000
S-3140	5 x 18"	24	98	93	87	82	1,000
S-3141	5 x 20"	27	108	103	98	91	1,000
S-3142	5 x 24"	32	129	123	116	107	1,000
S-3143	5 x 28"	37	149	142	133	125	1,000
S-1789	5 x 30"	40	164	154	147	138	1,000
S-1790	6 x 6"	9	44	41	39	37	1,000
S-2124	6 x 7"	10	47	45	43	40	1,000
S-1511	6 x 8"	11	\$43 per carton any quantity				1,000
S-1372	6 x 9"	13	62	58	56	51	1,000
S-1791	6 x 10"	17	65	62	57	54	1,000
S-1373	6 x 12"	19	74	70	66	63	1,000
S-3144	6 x 14"	20	82	79	74	69	1,000
S-2622	6 x 15"	22	87	82	79	72	1,000
S-1792	6 x 16"	24	93	87	82	79	1,000
S-2126	6 x 18"	26	111	104	100	93	1,000
S-1585	6 x 20"	29	116	107	102	97	1,000
S-3145	6 x 24"	38	140	132	124	118	1,000
S-3146	6 x 28"	45	164	154	147	138	1,000
S-1794	6 x 30"	48	184	173	164	153	1,000
S-3600	6 x 36"	28	117	111	103	98	500
S-3608	7 x 7"	12	57	53	50	47	1,000
S-2623	7 x 8"	14	67	64	60	57	1,000
S-2127	7 x 9"	15	72	69	65	61	1,000
S-1795	7 x 10"	17	80	75	71	67	1,000
S-2128	7 x 12"	22	87	82	79	72	1,000
S-3147	7 x 14"	24	95	89	83	80	1,000
S-2624	7 x 15"	28	98	93	87	82	1,000
S-3148	7 x 16"	30	108	103	98	91	1,000
S-3149	7 x 18"	32	120	114	106	102	1,000
S-3150	7 x 20"	37	140	132	124	118	1,000



MODEL NO.	OUTSIDE W x L	LBS./ CTN.	PRICE PER CARTON				QTY./ CTN.
			1	5	10	20+	
S-3151	7 x 24"	45	\$159	\$149	\$141	\$132	1,000
S-3152	7 x 30"	26	108	103	98	91	500
S-2924	8 x 8"	16	74	70	66	63	1,000
S-6345	8 x 9"	20	78	72	68	65	1,000
<b>S-1375</b>	<b>8 x 10"</b>	<b>21</b>	<b>\$64 per carton any quantity</b>				<b>1,000</b>
S-1512	8 x 12"	26	90	86	81	78	1,000
S-1798	8 x 14"	30	103	98	93	87	1,000
S-2625	8 x 15"	32	118	112	104	100	1,000
S-3153	8 x 16"	34	123	116	108	102	1,000
S-2444	8 x 18"	38	130	124	117	108	1,000
S-1586	8 x 20"	43	153	147	138	129	1,000
S-1800	8 x 24"	48	183	172	163	152	1,000
S-3154	8 x 28"	27	111	104	100	93	500
S-6346	8 x 30"	32	120	114	106	102	500
S-3601	8 x 36"	39	141	133	125	119	500
S-6347	8 x 40"	43	152	146	137	128	500
S-3155	9 x 9"	20	82	79	74	69	1,000
S-1801	9 x 10"	22	89	84	80	75	1,000
<b>S-1376</b>	<b>9 x 12"</b>	<b>26</b>	<b>\$87 per carton any quantity</b>				<b>1,000</b>
S-1589	9 x 14"	30	117	111	103	98	1,000
S-2626	9 x 15"	33	124	117	111	103	1,000
S-1802	9 x 16"	35	129	123	116	107	1,000
S-1803	9 x 18"	39	147	138	130	123	1,000
S-3156	9 x 20"	24	86	81	78	71	500
S-3157	9 x 24"	30	103	98	93	87	500
S-1804	10 x 10"	25	95	89	83	80	1,000
<b>S-1377</b>	<b>10 x 12"</b>	<b>32</b>	<b>\$93 per carton any quantity</b>				<b>1,000</b>
S-3412	10 x 13"	34	119	113	105	101	1,000
S-1513	10 x 14"	35	129	123	116	107	1,000
S-2627	10 x 15"	37	134	126	120	113	1,000
S-1805	10 x 16"	43	146	137	129	122	1,000
S-2628	10 x 18"	48	159	149	141	132	1,000
S-1806	10 x 20"	49	170	163	152	145	1,000
S-1807	10 x 24"	29	108	103	98	91	500
S-3158	10 x 30"	36	132	125	119	112	500
S-2134	11 x 12"	32	119	113	105	101	1,000
S-2135	11 x 14"	38	140	132	124	118	1,000
S-3159	11 x 15"	44	151	145	135	126	1,000
S-3160	11 x 16"	46	154	147	139	130	1,000
S-2136	11 x 18"	24	88	83	80	74	500
S-3161	11 x 20"	27	98	93	87	82	500
S-16401	11 x 24"	30	119	113	105	101	500
S-1514	12 x 12"	40	129	123	116	107	1,000
S-1808	12 x 14"	45	149	142	133	125	1,000
S-2646	12 x 15"	48	159	149	141	132	1,000
S-1515	12 x 16"	24	83	80	75	70	500
<b>S-1378</b>	<b>12 x 18"</b>	<b>27</b>	<b>\$79 per carton any quantity</b>				<b>500</b>
S-1809	12 x 20"	30	103	98	93	87	500
S-6348	12 x 22"	36	117	111	103	98	500
S-1516	12 x 24"	40	124	118	112	104	500
S-12312	12 x 26"	43	134	126	120	113	500
S-2925	12 x 30"	49	159	149	141	132	500
S-3162	12 x 36"	29	96	90	84	80	250
S-17682	12 x 48"	39	125	119	113	105	250
S-2647	13 x 16"	28	89	84	80	75	500



SOLD IN CARTON QUANTITIES

MODEL NO.	OUTSIDE W x L	LBS./ CTN.	PRICE PER CARTON				QTY./ CTN.
			1	5	10	20+	
S-6349	13 x 18"	32	\$102	\$96	\$90	\$84	500
S-3602	13 x 20"	36	113	106	102	96	500
S-3413	13 x 24"	38	134	126	120	113	500
S-3979	13 x 28"	44	154	147	139	130	500
S-1810	14 x 14"	47	169	161	151	142	1,000
S-1811	14 x 16"	30	98	93	87	82	500
S-1812	14 x 18"	34	111	104	100	93	500
S-1517	14 x 20"	37	123	116	108	102	500
S-3603	14 x 22"	41	132	125	119	112	500
S-1518	14 x 24"	43	147	138	130	123	500
S-3163	14 x 30"	25	90	86	81	78	250
S-3164	14 x 36"	30	111	104	100	93	250
S-6350	14 x 40"	38	123	116	108	102	250
S-3980	15 x 15"	30	98	93	87	82	500
S-2365	15 x 18"	36	118	112	104	100	500
S-2621	15 x 20"	40	129	123	116	107	500
S-2649	15 x 24"	48	153	147	138	129	500
S-3165	15 x 30"	30	98	93	87	82	250
S-6351	15 x 36"	36	118	112	104	100	250
S-3166	16 x 16"	31	112	105	101	95	500
S-1813	16 x 18"	34	124	118	112	104	500
S-1591	16 x 20"	39	140	132	124	118	500
S-1519	16 x 24"	46	164	154	147	138	500
S-11066	16 x 28"	30	98	93	87	82	250
S-1814	16 x 30"	29	103	98	93	87	250
S-3167	16 x 36"	35	124	118	112	104	250
S-2137	18 x 18"	39	141	133	125	119	500
S-2138	18 x 20"	44	153	147	138	129	500
<b>S-1379</b>	<b>18 x 24"</b>	<b>32</b>	<b>\$79 per carton any quantity</b>				<b>250</b>
S-1520	18 x 30"	26	93	87	82	79	200
S-3168	18 x 36"	31	113	106	102	96	200
S-6352	18 x 42"	41	130	124	117	108	200
S-1380	20 x 20"	27	87	82	79	72	250
S-1592	20 x 24"	32	103	98	93	87	250
S-17683	20 x 26"	35	113	106	102	96	250
S-2366	20 x 30"	40	129	123	116	107	250
S-1521	20 x 36"	44	153	147	138	129	250
S-2652	20 x 40"	24	87	82	79	72	125
S-3981	20 x 42"	41	147	138	130	123	200
S-3982	20 x 48"	46	164	154	147	138	200
S-12313	22 x 22"	34	103	98	93	87	250



**SOLD IN CARTON QUANTITIES**

MODEL NO.	OUTSIDE W x L	LBS./ CTN.	PRICE PER CARTON				QTY./ CTN.
			1	5	10	20+	
S-3169	22 x 24"	37	\$117	\$111	\$103	\$98	250
S-3170	22 x 30"	45	146	137	129	122	250
S-6353	22 x 36"	43	140	132	124	118	200
S-1522	24 x 24"	39	124	118	112	104	250
S-22701	24 x 26"	42	129	124	118	112	250
S-1523	24 x 30"	48	153	147	138	129	250
S-1381	24 x 36"	46	151	145	135	126	200
S-2653	24 x 38"	26	81	78	72	68	100
S-16402	24 x 40"	26	86	81	78	71	100
S-3171	24 x 42"	48	172	164	153	146	200
S-3172	24 x 48"	28	102	96	90	84	100
S-3983	24 x 60"	39	124	118	112	104	100
S-3984	26 x 26"	45	147	139	131	124	250
S-3173	26 x 30"	42	134	126	120	113	200
S-5401	26 x 36"	50	162	152	145	135	200
S-5402	26 x 42"	29	95	89	83	80	100
S-5403	26 x 48"	33	108	103	98	91	100
S-3174	28 x 32"	48	153	147	138	129	200
S-3604	28 x 36"	25	88	83	80	74	100

MODEL NO.	OUTSIDE W x L	LBS./ CTN.	PRICE PER CARTON				QTY./ CTN.
			1	5	10	20+	
S-2139	28 x 40"	27	\$98	\$93	\$87	\$82	100
S-5404	28 x 48"	33	118	112	104	100	100
S-3175	30 x 30"	48	153	147	138	129	200
S-1593	30 x 36"	29	93	87	82	79	100
S-6354	30 x 40"	32	103	98	93	87	100
S-3985	30 x 42"	36	111	104	100	93	100
S-3605	30 x 48"	38	124	118	112	104	100
S-3986	30 x 60"	48	153	147	138	129	100
S-3414	32 x 32"	25	88	83	80	74	100
S-3606	32 x 40"	31	112	105	101	95	100
S-2140	32 x 44"	34	123	116	108	102	100
S-3415	32 x 48"	37	132	125	119	112	100
S-5405	32 x 56"	44	153	147	138	129	100
S-5406	34 x 40"	36	119	113	105	101	100
S-2141	34 x 48"	44	142	135	126	120	100
S-1594	36 x 36"	35	113	106	102	96	100
S-1595	36 x 42"	40	130	124	117	108	100
S-3176	36 x 48"	47	149	142	133	125	100
S-2651	36 x 60"	29	93	87	82	79	50
S-5407	38 x 48"	49	154	147	139	130	100
S-2650	38 x 60"	30	101	95	89	83	50
S-3416	38 x 64"	33	105	102	96	89	50
S-5408	40 x 42"	44	147	138	130	123	100
S-3987	40 x 48"	26	83	80	75	70	50
S-2142	40 x 54"	29	93	87	82	79	50
S-5409	40 x 60"	32	103	98	93	87	50
S-11067	44 x 48"	28	90	86	81	78	50
S-3607	48 x 48"	31	102	96	90	84	50
S-5410	48 x 54"	35	113	106	102	96	50
S-2143	48 x 60"	39	124	118	112	104	50
S-11068	52 x 60"	21	67	64	60	57	25
S-11069	56 x 60"	23	74	70	66	63	25
S-12314	60 x 60"	26	80	74	70	66	25

# ULINE 8 MIL POLY BAGS



**EXTRA HEAVY DUTY**

Maximum protection for heavy industrial parts and sharp-edged materials.

- FDA and USDA compliant.
- 100% virgin polyethylene film.
- Combine sizes for volume discount.

MODEL NO.	OUTSIDE W x L	LBS./ CTN.	PRICE PER CARTON			QTY./ CTN.
			1	5	10+	
S-14427	8 x 10"	24	\$98	\$91	\$87	500
S-7001	9 x 12"	29	114	107	102	500
S-7002	10 x 12"	32	126	122	114	500
S-12506	10 x 14"	40	142	135	128	500
S-7003	12 x 16"	26	102	97	91	250
S-14428	12 x 18"	30	112	105	101	250
S-12507	12 x 20"	35	123	116	108	250
S-12508	16 x 20"	37	138	130	124	200
S-7004	18 x 24"	26	93	88	83	100
S-12509	20 x 24"	29	102	96	90	100
S-14429	24 x 30"	44	152	147	138	100
S-7005	24 x 36"	47	173	167	155	100
S-12510	30 x 36"	31	122	114	107	50
S-14430	36 x 48"	46	185	174	167	50
S-14431	48 x 48"	52	203	192	183	50

# ULINE 6 MIL POLY BAGS

## HEAVY DUTY

MODEL NO.	OUTSIDE W x L	LBS./ CTN.	PRICE PER CARTON			QTY./ CTN.
			1	5	10+	
S-12373	3 x 4"	6	\$32	\$29	\$28	1,000
S-3294	3 x 5"	7	38	37	35	1,000
S-3996	3 x 6"	8	45	43	40	1,000
S-11013	3 x 8"	10	53	49	47	1,000
S-3625	4 x 4"	6	42	40	38	1,000
S-3997	4 x 5"	8	49	47	45	1,000
S-3295	4 x 6"	9	56	51	49	1,000
S-3199	4 x 8"	12	68	65	62	1,000
S-11014	4 x 10"	16	79	72	69	1,000
S-8457	4 x 12"	20	80	75	71	1,000
S-11015	4 x 16"	26	100	93	88	1,000
S-11016	5 x 5"	10	62	58	56	1,000
S-11017	5 x 6"	12	67	64	60	1,000
S-3998	5 x 7"	13	71	68	65	1,000
S-3200	5 x 8"	15	79	72	69	1,000
S-11018	5 x 10"	20	82	80	74	1,000
S-11019	5 x 12"	24	93	88	83	1,000
S-6355	6 x 6"	15	74	70	67	1,000
S-1646	6 x 8"	20	\$70 per carton any quantity			1,000
S-3296	6 x 9"	22	100	93	88	1,000
S-2396	6 x 10"	24	102	98	91	1,000
S-2397	6 x 12"	29	126	122	114	1,000
S-11020	6 x 16"	38	147	138	130	1,000
S-3999	7 x 9"	25	112	105	101	1,000
S-11021	7 x 10"	28	114	107	102	1,000
S-11022	7 x 14"	39	141	133	126	1,000
S-11023	8 x 8"	26	112	105	101	1,000
S-2398	8 x 10"	32	129	124	117	1,000
S-1647	8 x 12"	38	134	126	120	1,000
S-2926	8 x 14"	23	83	80	75	500
S-11024	8 x 18"	29	96	90	86	500
S-11025	8 x 20"	32	103	100	93	500
S-11026	9 x 10"	36	147	139	131	1,000
S-2399	9 x 12"	22	\$90 per carton any quantity			500
S-11027	9 x 14"	25	113	106	102	500
S-11028	9 x 16"	29	122	114	107	500
S-2927	10 x 12"	24	103	100	93	500
S-2400	10 x 14"	28	116	108	103	500
S-3201	10 x 16"	32	124	117	111	500
S-8458	10 x 18"	37	134	126	120	500
S-11029	10 x 24"	24	83	80	75	250
S-8459	12 x 12"	29	113	106	102	500
S-11030	12 x 14"	34	125	120	113	500
S-12374	12 x 15"	37	126	122	114	500
S-1648	12 x 16"	39	128	123	116	500
S-2401	12 x 18"	43	169	161	151	500
S-3626	12 x 20"	48	186	175	168	500
S-12375	12 x 24"	30	100	93	88	250
S-6356	12 x 26"	33	124	117	111	250
S-11031	12 x 30"	36	132	125	119	250
S-11032	14 x 16"	44	151	146	137	500
S-6357	14 x 18"	51	191	180	170	500

Eliminate tears, punctures and broken bags.

- Recommended for use with heavy metal parts.
- Virgin polyethylene film.
- Meets FDA and USDA specifications.



### SOLD IN CARTON QUANTITIES

MODEL NO.	OUTSIDE W x L	LBS./ CTN.	PRICE PER CARTON			QTY./ CTN.
			1	5	10+	
S-11033	14 x 20"	28	\$112	\$105	\$101	250
S-5000	14 x 24"	34	134	126	120	250
S-11034	14 x 30"	34	125	120	113	200
S-11035	16 x 16"	26	101	95	89	250
S-5001	16 x 18"	26	117	111	104	250
S-1649	16 x 20"	32	124	117	111	250
S-11036	16 x 24"	38	135	128	122	250
S-2928	16 x 30"	49	167	155	148	250
S-11037	18 x 18"	32	137	129	123	250
S-2929	18 x 24"	44	162	152	146	250
S-2930	18 x 30"	44	162	152	146	200
S-6358	18 x 36"	52	198	189	177	200
S-11038	20 x 20"	40	156	149	141	250
S-2931	20 x 24"	48	174	168	156	250
S-3627	20 x 30"	48	174	168	156	200
S-6359	20 x 36"	58	217	207	195	200
S-3628	24 x 24"	46	170	163	152	200
S-11039	24 x 30"	29	114	107	102	100
S-2932	24 x 36"	35	131	124	118	100
S-11040	24 x 42"	40	150	145	135	100
S-3629	24 x 48"	46	169	161	151	100
S-11041	24 x 60"	29	111	104	100	50
S-11042	28 x 32"	36	140	132	125	100
S-11043	28 x 36"	40	155	148	140	100
S-11051	28 x 48"	27	98	91	87	50
S-11044	30 x 30"	36	132	125	119	100
S-3630	30 x 36"	43	162	152	146	100
S-6360	30 x 40"	48	183	172	164	100
S-11045	30 x 60"	36	128	123	116	50
S-11046	36 x 36"	26	91	87	82	50
S-3459	36 x 48"	35	113	106	102	50
S-11047	36 x 60"	22	78	71	68	25
S-11048	38 x 48"	36	126	122	114	50
S-11049	38 x 60"	23	74	70	67	25
S-6361	38 x 64"	49	163	153	147	50
S-11050	38 x 65"	25	84	81	78	25
S-6362	48 x 48"	47	147	139	131	50
S-6363	48 x 54"	53	167	155	148	50
S-12376	48 x 60"	30	100	93	88	25
S-6364	60 x 60"	36	116	108	103	25



Fitted bottom and expandable sides form to the shape of your product.

- 100% virgin, high clarity polyethylene film.
- Meets FDA and USDA specifications.

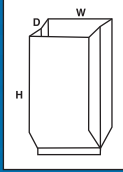

### 1 MIL

MODEL NO.	SIZE W x D x H	LBS./CTN.	PRICE PER CARTON				QTY./CTN.
			1	5	10	20+	
S-7490	4 x 2 x 8"	4	\$20	\$19	\$18	\$17	1,000
S-11070	4 x 2 x 10"	5	22	21	20	19	1,000
S-7491	4 x 2 x 12"	6	27	26	23	22	1,000
S-16565	5 x 2 x 12"	6	28	27	24	23	1,000
S-17684	5 x 3 x 10"	6	27	26	23	22	1,000
S-8445	5 x 3 x 15"	8	37	35	34	30	1,000
S-16566	5 x 4 x 12"	7	35	32	30	28	1,000
S-11071	5 x 4 x 15"	10	43	40	38	36	1,000
S-17685	5 x 4 x 21"	12	57	54	51	48	1,000
S-16567	5 x 4 x 24"	14	66	63	60	56	1,000
S-15884	6 x 3 x 12"	8	36	34	32	29	1,000
S-7492	6 x 3 x 15"	10	43	40	38	36	1,000
S-16568	6 x 3 x 18"	11	49	47	44	41	1,000
S-7493	6 x 4 x 15"	11	46	43	41	39	1,000
S-16569	6 x 4 x 18"	12	57	53	50	47	1,000
S-16570	6 x 4 x 20"	13	62	57	54	50	1,000
S-8446	8 x 3 x 15"	11	49	47	44	41	1,000
S-16571	8 x 3 x 20"	15	66	63	60	56	1,000
S-11072	8 x 4 x 12"	11	46	43	41	39	1,000
S-16572	8 x 4 x 15"	12	54	50	48	45	1,000
S-7494	8 x 4 x 18"	15	62	57	54	50	1,000
S-17686	8 x 4 x 21"	17	68	64	61	57	1,000
S-17687	9 x 6 x 18"	20	71	68	64	61	1,000
S-11073	10 x 4 x 20"	20	69	66	62	57	1,000
S-16573	10 x 6 x 20"	22	79	72	69	65	1,000
S-7495	10 x 8 x 24"	29	106	101	95	88	1,000
S-7496	12 x 8 x 20"	14	51	49	46	44	500
S-7497	12 x 8 x 24"	17	63	60	56	51	500
S-7498	12 x 8 x 30"	21	72	69	65	62	500
S-17688	15 x 9 x 23"	20	72	69	65	62	500
S-17689	15 x 9 x 24"	21	78	71	68	64	500
S-17690	15 x 9 x 32"	27	101	95	89	84	500
S-8447	15 x 11 x 18"	17	62	57	54	50	500
S-17691	16 x 14 x 24"	25	95	89	84	80	500
S-7499	24 x 20 x 48"	29	90	86	80	75	200
S-7560	26 x 24 x 48"	33	102	97	90	85	200
S-7561	30 x 18 x 48"	32	98	91	87	81	200
S-7562	30 x 26 x 60"	46	135	128	120	113	200

### 2 MIL

MODEL NO.	SIZE W x D x H	LBS./CTN.	PRICE PER CARTON				QTY./CTN.
			1	5	10	20+	
S-5806	3 x 2 x 8"	6	\$26	\$25	\$23	\$22	1,000
S-5807	4 x 2 x 6"	6	26	25	23	22	1,000
S-120	4 x 2 x 8"	7	30	29	27	26	1,000
S-3285	4 x 2 x 10"	9	37	35	34	31	1,000
S-121	4 x 2 x 12"	10	46	43	41	39	1,000
S-7500	4 x 2 x 14"	12	49	47	44	41	1,000
S-11074	4 x 2 x 20"	17	63	60	56	51	1,000
S-1815	5 x 2 x 12"	12	49	47	44	41	1,000
S-6545	5 x 3 x 12"	14	51	49	46	44	1,000
S-1566	5 x 3 x 15"	16	63	60	56	51	1,000
S-11075	5 x 4 x 24"	30	98	91	87	81	1,000
S-1891	6 x 3 x 12"	15	62	57	54	50	1,000
S-122	6 x 3 x 15"	19	65	62	57	54	1,000
S-2402	6 x 3 x 18"	22	72	69	65	62	1,000
S-3508	6 x 3 x 20"	25	83	79	72	68	1,000
S-6546	6 x 4 x 12"	17	63	60	56	51	1,000
S-1503	6 x 4 x 15"	21	71	68	64	61	1,000
S-3509	6 x 4 x 20"	27	90	86	80	75	1,000
S-6572	7 x 2 x 6"	13	34	31	30	28	1,000
S-8448	7 x 4 x 18"	27	90	86	80	75	1,000
S-2403	8 x 3 x 15"	23	80	78	71	67	1,000
S-16574	8 x 3 x 18"	27	96	90	86	80	1,000
S-2404	8 x 3 x 20"	30	98	91	87	81	1,000
S-6547	8 x 4 x 12"	20	79	72	69	65	1,000
S-1504	8 x 4 x 15"	25	86	81	78	71	1,000
S-6548	8 x 4 x 16"	26	89	84	80	74	1,000
S-123	8 x 4 x 18"	30	\$75 per carton any quantity				1,000
S-7501	8 x 4 x 20"	33	108	102	97	90	1,000
S-8449	8 x 4 x 21"	34	113	107	101	95	1,000
S-2405	8 x 4 x 22"	36	118	111	104	98	1,000
S-3510	8 x 4 x 24"	20	66	63	60	56	500
S-6549	8 x 8 x 16"	35	130	123	116	108	1,000
S-1254	10 x 4 x 20"	38	124	118	111	103	1,000
S-2406	10 x 4 x 24"	46	145	137	128	120	1,000
S-6550	10 x 6 x 18"	39	141	133	125	118	1,000
S-6551	10 x 6 x 20"	43	147	138	130	122	1,000
S-1569	10 x 6 x 24"	26	84	80	74	69	500
S-3511	10 x 6 x 30"	33	102	97	90	85	500

Heavy-duty protection for bulky parts and equipment.

- Larger sizes for use as liners for cartons or large bins.
- Meets FDA and USDA specifications.
- See pages 142-143 for Pallet Covers.



## 2 MIL

MODEL NO.	SIZE W x D x H	LBS./CTN.	PRICE PER CARTON				QTY./CTN.
			1	5	10	20+	
S-11076	10 x 8 x 16"	40	\$124	\$118	\$111	\$103	1,000
S-1505	10 x 8 x 20"	25	83	79	72	68	500
<b>S-1255</b>	<b>10 x 8 x 24"</b>	<b>30</b>	<b>\$72 per carton any quantity</b>				<b>500</b>
S-3286	10 x 8 x 30"	37	114	108	102	96	500
S-8491	10 x 10 x 24"	33	102	97	90	85	500
S-1892	12 x 4 x 18"	20	66	63	60	56	500
S-124	12 x 6 x 24"	30	90	86	80	75	500
S-3780	12 x 8 x 20"	27	87	83	79	72	500
S-1816	12 x 8 x 24"	33	102	97	90	85	500
<b>S-1256</b>	<b>12 x 8 x 30"</b>	<b>41</b>	<b>\$102 per carton any quantity</b>				<b>500</b>
S-6552	12 x 8 x 32"	43	134	126	119	112	500
S-3781	12 x 10 x 24"	36	113	107	101	95	500
S-16575	12 x 10 x 30"	44	147	138	130	122	500
S-6553	12 x 12 x 18"	30	100	93	88	83	500
S-3287	12 x 12 x 24"	39	124	118	111	103	500
S-8492	12 x 12 x 30"	25	80	78	71	67	250
S-6554	12 x 12 x 36"	30	90	86	80	75	250
S-13451	12 x 12 x 48"	39	130	123	116	108	250
S-8493	13 x 10 x 30"	47	142	134	126	119	500
S-2903	14 x 14 x 26"	49	149	141	133	124	500
S-8450	14 x 14 x 36"	35	104	100	93	87	250
S-2407	15 x 9 x 24"	39	124	118	111	103	500
S-7502	15 x 9 x 32"	26	84	80	74	69	250
S-6555	16 x 10 x 32"	29	90	86	80	75	250
S-2904	16 x 12 x 30"	29	90	86	80	75	250
S-3512	16 x 12 x 36"	34	104	100	93	87	250
S-8494	16 x 14 x 24"	25	83	79	72	68	250
S-8451	16 x 14 x 30"	31	97	90	86	80	250
S-6556	16 x 14 x 36"	37	114	108	102	96	250
S-3288	18 x 8 x 32"	28	90	86	80	75	250
S-17692	18 x 12 x 45"	45	150	142	134	125	250
S-15885	18 x 14 x 36"	38	130	123	116	108	250
S-15886	18 x 16 x 40"	46	145	137	128	120	250
S-8495	18 x 18 x 40"	49	148	140	132	124	250
S-7503	20 x 8 x 36"	34	104	100	93	87	250
S-3782	20 x 10 x 36"	37	114	108	102	96	250
S-8496	20 x 13 x 39"	44	134	126	119	112	250
S-17693	20 x 13 x 48"	42	140	132	124	117	200

## 2 MIL

MODEL NO.	SIZE W x D x H	LBS./CTN.	PRICE PER CARTON				QTY./CTN.
			1	5	10	20+	
S-15887	20 x 16 x 60"	29	\$98	\$91	\$87	\$81	100
S-1257	20 x 18 x 26"	27	86	81	78	71	200
S-3783	20 x 18 x 30"	31	98	91	87	81	200
S-2905	20 x 18 x 36"	46	139	131	124	116	250
S-6557	20 x 20 x 48"	52	154	147	137	128	200
S-17694	22 x 16 x 27"	34	116	110	102	97	250
S-8497	22 x 16 x 59"	31	98	91	87	81	100
S-13452	23 x 17 x 46"	50	161	150	142	133	200
S-17695	23 x 18 x 34"	37	125	119	112	104	200
S-7504	24 x 10 x 36"	33	102	97	90	85	200
S-16576	24 x 10 x 48"	43	145	137	128	120	200
S-16577	24 x 12 x 36"	34	114	108	102	96	200
S-11077	24 x 16 x 24"	32	98	91	87	81	250
<b>S-2906</b>	<b>24 x 20 x 48"</b>	<b>29</b>	<b>\$71 per carton any quantity</b>				<b>100</b>
S-16578	24 x 24 x 48"	30	102	97	90	85	100
S-7505	26 x 24 x 48"	33	102	97	90	85	100
S-16579	26 x 24 x 60"	40	133	125	118	111	100
S-16580	28 x 24 x 52"	36	119	112	106	100	100
S-2907	28 x 24 x 60"	42	133	125	118	111	100
S-7506	30 x 18 x 48"	32	98	91	87	81	100
S-2908	30 x 26 x 60"	46	135	128	120	113	100
S-17696	31 x 21 x 39"	27	87	83	79	72	100
S-5425	32 x 28 x 48"	39	124	118	111	103	100
S-5426	32 x 28 x 60"	49	158	149	140	132	100
S-5427	36 x 32 x 48"	44	145	137	128	120	100
S-8452	38 x 36 x 70"	36	113	107	101	95	50

## 3 MIL

(Continued on page 139)

S-7507	4 x 2 x 8"	11	\$47	\$44	\$41	\$39	1,000
S-5394	4 x 2 x 12"	15	62	57	54	51	1,000
S-6558	5 x 2 x 12"	18	64	61	57	53	1,000
S-6559	5 x 3 x 15"	25	83	79	72	68	1,000
S-6560	6 x 3 x 12"	23	72	69	65	62	1,000
S-16581	6 x 3 x 15"	27	93	88	83	79	1,000
S-16582	6 x 3 x 18"	32	112	106	100	93	1,000
S-6561	6 x 4 x 15"	31	100	93	88	83	1,000
S-16583	8 x 3 x 15"	33	113	107	101	95	1,000
S-16584	8 x 3 x 20"	44	150	142	134	125	1,000

# BAG TAPE



UPVC 2.4 mil tape provides an excellent seal for poly bags.

- Use with both bag tapers shown below. • 3" core.

## SPECIAL OFFER!

ORDER 6+ CARTONS OF 3/8" TAPE AND RECEIVE 1 FREE H-167 BAG TAPER.

MODEL NUMBERS						TAPE SIZE	RLS./ CTN.	PRICE PER CARTON		
								1	3	6+
S-387	Red	S-2085	Orange	S-388	Li. Blue	3/8" x 540'	16	\$59	\$55	\$52
S-389	Green	S-314	White	S-3240	Clear					
S-3813	Black	S-3239	Yellow	S-3814	Navy					
S-7907	Red	S-7906	Green	S-7908	White	5/8" x 540'	16	97	91	86
S-5365	Assortment Pack – 2 rolls of each: Red, White, Green and Light Blue				3/8" x 540'	8	42	39	35	



H-167

## BAG TAPERS

**STANDARD** – Easy to use. Twist mouth of bag shut and move through slot. 3/8" wide throat.

**HEAVY DUTY** – 5/8" throat seals **heavy mil** bags. Built-in trimmer. All steel taper with sturdy base. Uses 3/8" and 5/8" wide tape.

- Pre-drilled holes in base for mounting taper to work surfaces.



H-109

MODEL NO.	DESCRIPTION	TAPE WIDTH CAPACITY	PRICE EACH		
			1	2	4+
H-167	Bag Taper	3/8"	\$20	\$18	\$16
H-109	Heavy Duty Bag Taper	5/8"	43	40	38
H-167B	Extra blade to cut tape – \$5 ea.	H-167D	Extra blade to trim bag – \$5 ea.		
H-109B	Extra blade to cut tape – \$5 ea.	H-109D	Extra blade to trim bag – \$5 ea.		



## PLASTIC TWIST TIES

### PRE-CUT TIES

MODEL NO.	LENGTH	WIDTH	QTY./ CTN.	PRICE PER CARTON		
				1	5	10+
S-566	4"			\$10	\$9	\$8
S-3810	5"			12	11	10
S-2505	6"			13	12	11
S-15025	7"			17	14	13
S-567	8"	5/32"	2,000	20	19	17
S-3811	9"			22	19	18
S-3812	10"			24	21	20
S-1261	12"			26	23	22
S-11130*	18"			53	45	42

\* Available in Red, Black, White and Clear

Reusable twist ties attach labels and close food and parts bags.

- Moisture resistant – Can be used outdoors.
- 5/32" wide, 27 gauge flexible wire.
- Clear recommended for medical industry use.



### SPOOLS

Customize lengths or use with automatic machines.

MODEL NO.	LENGTH	WIDTH	QTY./ CTN.	PRICE EACH		
				1	3	5+
S-568	7,000'	5/32"	1	\$80	\$78	\$76

### COLORS AVAILABLE:

Pre-Cut and Spool styles available in: Red, Yellow, Blue, White, Green, Clear and Black. Specify color.



### METALLIC PRE-CUT TIES

MODEL NO.	LENGTH	WIDTH	QTY./ CTN.	PRICE PER CARTON		
				1	5	10+
S-5353	4"	5/32"	2,000	\$32	\$30	\$29
S-5354	8"	5/32"	2,000	60	56	55

### METALLIC COLORS:

Specify color: Red, Blue, Gold, Silver or Green.



# ULINE GUSSETED POLY BAGS

**3 MIL**

(Continued from page 137)

MODEL NO.	SIZE W x D x H	LBS./CTN.	PRICE PER CARTON				QTY./CTN.
			1	5	10	20+	
S-5412	8 x 4 x 15"	37	\$123	\$117	\$110	\$102	1,000
S-5413	8 x 4 x 18"	44	147	138	130	122	1,000
S-16585	8 x 4 x 22"	26	90	86	80	75	500
S-6562	10 x 4 x 20"	29	90	86	80	75	500
S-16586	10 x 4 x 24"	34	116	110	102	97	500
S-16587	10 x 6 x 20"	33	108	102	97	90	500
S-6570	10 x 6 x 22"	36	113	107	101	95	500
S-16588	10 x 6 x 24"	38	130	123	116	108	500
S-6571	10 x 8 x 20"	37	114	108	102	96	500
S-5414	10 x 8 x 24"	44	135	128	120	113	500
S-6563	12 x 6 x 24"	44	135	128	120	113	500
S-11078	12 x 8 x 20"	40	133	125	118	111	500
S-5415	12 x 8 x 24"	49	154	147	137	128	500
S-5416	12 x 8 x 30"	31	119	112	106	100	250
S-16589	12 x 10 x 24"	26	98	91	87	81	250
S-16590	12 x 10 x 30"	33	120	113	107	101	250
S-17697	12 x 12 x 18"	22	89	84	80	74	250
S-5417	12 x 12 x 24"	30	114	108	102	96	250
S-5418	12 x 12 x 30"	37	140	132	124	117	250
S-5419	14 x 14 x 26"	38	142	134	126	119	250
S-8443	14 x 14 x 30"	42	147	138	130	122	250
S-6564	15 x 9 x 24"	30	123	117	110	102	250
S-5420	15 x 9 x 32"	39	140	132	124	117	250
S-16591	16 x 10 x 32"	41	161	150	142	133	250
S-11079	16 x 12 x 30"	34	126	120	113	106	200
S-6565	16 x 14 x 24"	37	148	140	132	124	250
S-16592	16 x 14 x 30"	45	183	171	163	151	250
S-15888	16 x 14 x 36"	54	186	177	167	155	250
S-11080	18 x 8 x 24"	32	119	112	106	100	250
S-5421	18 x 14 x 36"	47	145	137	128	120	200
S-5422	18 x 16 x 40"	28	90	86	80	75	100
S-16593	20 x 10 x 36"	44	156	148	139	131	200
S-16594	20 x 16 x 42"	30	111	103	98	91	100
S-13453	20 x 18 x 26"	21	71	68	64	61	100
S-7508	20 x 18 x 36"	29	90	86	80	75	100
S-16595	20 x 20 x 48"	38	132	124	117	110	100
S-16596	24 x 10 x 36"	25	86	81	78	71	100
S-16597	24 x 10 x 48"	32	114	108	102	96	100
S-11081	24 x 12 x 36"	26	84	80	74	69	100
S-7509	24 x 20 x 48"	22	71	68	64	61	50
S-5423	24 x 24 x 48"	24	80	78	71	67	50
S-5424	26 x 24 x 48"	25	83	79	72	68	50

## HEAVY-DUTY PROTECTION FOR BULKY ITEMS



**3 MIL**

MODEL NO.	SIZE W x D x H	LBS./CTN.	PRICE PER CARTON				QTY./CTN.
			1	5	10	20+	
S-16598	26 x 24 x 60"	30	\$106	\$101	\$95	\$88	50
S-16599	28 x 24 x 60"	31	112	106	100	93	50
S-7510	30 x 18 x 48"	24	80	78	71	67	50
S-16600	30 x 26 x 60"	33	120	113	107	101	50
S-13454	32 x 28 x 48"	29	98	91	87	81	50
S-13455	36 x 32 x 48"	34	112	106	100	93	50
S-13456	38 x 36 x 70"	51	171	163	153	145	50

**4 MIL**

S-17698	5 x 3 x 15"	16	\$65	\$62	\$57	\$54	500
S-11082	8 x 4 x 18"	29	97	90	86	80	500
S-17699	8 x 6 x 18"	34	116	110	102	97	500
S-17700	10 x 8 x 20"	24	83	79	73	69	250
S-11083	10 x 8 x 24"	29	97	90	86	80	250
S-7513	12 x 8 x 24"	33	102	97	90	85	250
S-11084	12 x 8 x 30"	32	102	97	90	85	200
S-7514	15 x 9 x 24"	40	124	118	111	103	250
S-17701	16 x 14 x 36"	29	95	89	84	80	100
S-7515	18 x 14 x 36"	31	98	91	87	81	100
S-13457	18 x 16 x 40"	38	119	112	106	100	100
S-15889	20 x 18 x 36"	37	132	124	117	110	100
S-17702	23 x 17 x 46"	25	85	80	75	70	50
S-7570	24 x 10 x 36"	17	62	57	54	50	50
S-11085	24 x 20 x 48"	29	90	86	80	75	50
S-7516	28 x 24 x 60"	43	133	125	118	111	50
S-13458	36 x 32 x 48"	45	147	138	130	122	50
S-7571	40 x 22 x 72"	60	180	169	159	149	50

**6 MIL**

S-11086	8 x 4 x 16"	39	\$124	\$118	\$111	\$103	500
S-11087	12 x 8 x 24"	39	124	118	111	103	200
S-15890	22 x 16 x 58"	44	150	142	134	125	50
S-11089	28 x 24 x 60"	63	191	181	169	159	50

## PAPER TWIST TIES

Provide a tight grip for bakery, grocery and garbage bags.

- Won't come apart when baked, boiled or frozen.

MODEL NO.	LENGTH	WIDTH	QTY./CTN.	PRICE PER CARTON		
				2	5	10+
S-15874	4"			\$8	\$7	\$6
S-15875	7"	5/32"	2,000	14	12	11
S-19797	8"			16	14	12

- 27 gauge flexible wire.
- Flush-cut for safe handling.
- Additional ties, see page 138.

SPECIFY COLOR:  White  Red  Green  Blue  Red/White  Yellow  Orange  Black



# ULINE POLY COVERS



Extra-large bags keep furniture and equipment clean.

- Perforated on a roll for easy tear-off.
- Protect stored items from dirt and dust.



## 1 MIL

MODEL NO.	COVER SIZE W x H	RECOMMENDED FURNITURE USE	MIL	QTY./ROLL	LBS./ROLL	PRICE/ROLL	
						1	2+
S-14452	45 x 30"	22" Chair	1	500	45	\$173	\$158
S-5844	54 x 45"	29" Chair		275	45		
S-2896	70 x 45"	29-36" Chair		215	46		
S-3899	76 x 45"	36-42" Chair		200	46		
S-11107	84 x 45"	42-50" Chair		180	46		
S-2897	90 x 45"	50-56" Chair	165	45			
S-11108	92 x 45"	56-60" Chair	1	160	45	173	158
S-2898	106 x 45"	60-70" Loveseat		140	45		
S-5845	124 x 45"	90" Sofa		125	47		
S-2899	140 x 45"	100-106" Sofa		100	43		
S-5846	152 x 45"	116" Sofa		100	46		

## 3 MIL

S-14453	45 x 30"	22" Chair	3	175	45	\$173	\$158
S-11109	54 x 45"	29" Chair		100	49		
S-11110	90 x 45"	50-56" Chair		55	45		
S-8388	106 x 45"	60-70" Loveseat		50	49		
S-8389	124 x 45"	90" Sofa		40	46		
S-8390	140 x 45"	100-106" Sofa		35	45		
S-8391	152 x 45"	116" Sofa		35	49		

## GARMENT BAGS



Pre-slit hole for hanger.

- Printed with child safety warning.
- Convenient dispenser roll.

- 7" deep bags for covering multiple garments.

MODEL NO.	SIZE W x D x H	RECOMMENDED USE	MIL	QTY./ROLL	PRICE PER ROLL		
					1	2	4+
S-5857	21 x 4 x 30"	Pants	0.6	650	\$58	\$56	\$54
S-5858	21 x 4 x 38"	Suit		510			
S-5859	21 x 4 x 54"	Coat		360			
S-5860	21 x 4 x 72"	Dress		270			
S-20585	21 x 7 x 40"	Suit	0.6	470	60	58	56
S-20586	21 x 7 x 54"	Coat		350			
S-20587	21 x 7 x 72"	Dress		260			

## MATTRESS BAGS



Excellent protection from dirt and moisture.

- Low-slip polyethylene with vent holes.
- Perforated on a roll for easy tear-off.
- Gusseted for a better fit.

### STANDARD

MODEL NO.	COVER SIZE W x D x L	MATTRESS SIZE	MIL	QTY./ROLL	LBS./ROLL	PRICE/ROLL	
						1	2+
S-5847	39 x 8 x 90"	Twin	1.5	100	37	\$118	\$108
S-8402	39 x 10 x 90"		4.0	25	30	87	80
S-5848	54 x 8 x 90"	Double	1.5	100	49	153	143
S-8403	54 x 12 x 90"		4.0	25	40	111	104
S-7256	60 x 8 x 90"	Queen	1.5	100	56	163	151
S-8404	60 x 12 x 90"		4.0	25	50	118	108
■ S-3538	78 x 8 x 90"	King	1.5	100	77	200	185
S-8405	78 x 12 x 90"		4.0	25	61	143	131

### PILLOW TOP

S-22702	39 x 15 x 90"	Twin	4.0	25	33	\$97	\$90
S-22703	54 x 15 x 90"	Double			42	119	108
S-12343	60 x 18 x 105"	XL Queen			68	147	137
■ S-12344	78 x 18 x 105"	XL King			73	177	166

■ SHIPS VIA MOTOR FREIGHT

# ULINE DOORKNOB BAGS

Samples, flyers and catalogs slip easily into these bags.

- 1½" hang hole fits standard doorknobs.
- Strong, high-quality bags made of 100% virgin film.

Tri-fold Brochures – 4 x 12" – S-12191.

White Bags – Conceal contents.

\* SPECIFY COLOR: Clear or White

MODEL NO.	SIZE W x L	USABLE DIMENSIONS	MIL	QTY./ CTN.	PRICE PER CARTON		
					1	5	10+
S-11001	4 x 10"	3¾ x 7"	2		\$23	\$22	\$21
S-12191*	4 x 12"	3¾ x 9"	1.5		24	23	22
S-17725	4 x 16"	3¾ x 13"	1.5	1,000	27	26	24
S-2176*	6 x 12"	5¾ x 9"	1.5		\$30/ctn. any qty.		
S-9923	6 x 16"	5¾ x 13"	1.5		38	37	35
S-2177*	9 x 14"	8¾ x 11"	1.5		\$43/ctn. any qty.		
S-5808	9 x 16"	8¾ x 13"	1.5		51	48	46
S-19798	10 x 15"	9¾ x 12"	1.5	1,000	53	50	47
S-8466	10 x 17"	9¾ x 14"	1.5		60	57	54
S-2269	12 x 14"	11½ x 11"	1.5		61	58	56



S-12191  
For Tri-fold Brochures



White



# NEWSPAPER/SPECIALTY BAGS

Deliver a clean, dry newspaper in any weather!

- Recommended for samples, flyers and catalogs.
- Perforated for easy tear-off.

▲ SPECIFY COLOR: Clear Orange

MODEL NO.	SIZE W x L	RECOM. USE	MIL	QTY./ CTN.	PRICE PER CARTON		
					1	5	10+
S-12341	6 x 16"	Tabloids	.65	2,000	\$39	\$37	\$35
S-12342▲	7½ x 21"	Newspapers			57	54	50
S-14432	10 x 16"	Sunday Papers			61	57	54
S-14433	10 x 21"				78	72	68
S-8467*	7½ x 25"	Broadsheets	1.5	1,000	62	58	56

\* Includes 1½" doorknob hole, individually packed in box



1.5" Doorknob Hole

# POLY BAGS ON A ROLL

MEETS FDA AND USDA REQUIREMENTS

MODEL NO.	SIZE W x L	MIL	BAGS/ ROLL	LBS./ ROLL	PRICE PER ROLL		
					1	3	6+
S-13598	9 x 12"	2	1,000	20	\$81	\$78	\$74
S-11151	12 x 18"		1,000	29	107	102	95
S-13599	16 x 20"		1,000	54	163	154	145
S-11152	18 x 24"		1,000	58	166	160	152
S-17726	20 x 30"		500	34	142	134	126
S-13600	24 x 30"		500	51	154	146	137
S-11153	24 x 36"		500	58	162	155	148
S-13601	30 x 36"		250	46	113	107	102
S-11154	36 x 48"		200	47	126	120	113

Protect large items from dirt and dust.

- Perforated for easy tear-offs.
- Roll converts from 1" to 3" core.

## DISPENSERS

Wall, bench or tabletop mount, page 150.







### 3 MIL

MODEL NO.	FITS PALLET L x W x H	COVER SIZE W x D x H	BAGS/ROLL	LBS./ROLL	PRICE PER ROLL		
					1	2	5+
■S-8368	48 x 40 x 65"	60 x 40 x 85"	50	85	\$256	\$228	\$207
■S-7522	48 x 42 x 48"	48 x 48 x 72"	50	75	211	190	169
■S-8365	48 x 42 x 60"	48 x 48 x 84"	50	81	229	209	186
■S-8366	48 x 42 x 78"	48 x 48 x 102"	50	98	288	260	240
■S-5114	48 x 42 x 40"	70 x 44 x 62"	50	72	219	195	182
■S-11100	48 x 42 x 33"	72 x 42 x 54"	50	73	202	182	163
■S-11098	48 x 48 x 48"	51 x 49 x 73"	50	80	224	202	186
■S-3291	48 x 48 x 60"	51 x 49 x 85"	50	87	265	239	212
■S-3292	48 x 48 x 72"	51 x 49 x 97"	50	100	300	272	242
■S-3540	48 x 48 x 36"	52 x 48 x 60"	50	60	198	179	160
■S-2059	48 x 48 x 49"	52 x 48 x 73"	50	69	227	205	188
■S-2060	48 x 48 x 64"	52 x 48 x 88"	50	90	268	242	215
■S-12486	48 x 48 x 106"	52 x 48 x 130"	35	96	303	274	244
■S-3293	64 x 64 x 54"	68 x 65 x 87"	50	117	400	370	349



### 4 MIL

S-11101	42 x 36 x 62"	44 x 36 x 80"	25	43	\$137	\$117	\$110
S-13550	42 x 36 x 51"	42 x 42 x 72"	25	42	127	113	103
S-13551	42 x 36 x 75"	42 x 42 x 96"	25	49	169	155	142
S-13552	42 x 42 x 51"	46 x 42 x 72"	25	43	132	123	111
S-13553	48 x 40 x 27"	48 x 42 x 48"	25	46	90	83	75
S-13554	48 x 40 x 45"	48 x 42 x 66"	25	42	126	114	106
S-12525	48 x 40 x 49"	48 x 46 x 72"	25	52	164	150	140
S-11102	48 x 40 x 73"	48 x 46 x 96"	25	61	180	160	150
S-13555	48 x 40 x 48"	48 x 48 x 72"	25	46	145	130	123
S-13556	48 x 40 x 72"	48 x 48 x 96"	25	53	196	176	167
S-13557	48 x 48 x 48"	51 x 49 x 73"	25	48	153	140	128
S-8355	48 x 48 x 72"	51 x 49 x 97"	25	65	196	180	160
S-8356	48 x 40 x 72"	52 x 48 x 96"	25	64	194	177	159
S-11103	48 x 40 x 50"	54 x 44 x 72"	25	48	144	126	116
S-8358	48 x 40 x 52"	55 x 45 x 75"	25	50	152	132	124
S-8357	48 x 48 x 34"	54 x 52 x 60"	25	43	130	113	105
■S-11104	58 x 41 x 73"	58 x 46 x 96"	25	75	202	176	163
■S-8359	64 x 64 x 49"	68 x 65 x 82"	25	73	217	191	176

Maximum protection for industrial equipment.

- Superior strength eliminates punctures and tears.
- Perforated on a roll for easy dispensing.

■ SHIPS VIA MOTOR FREIGHT

## BLACK PALLET COVERS



Conceal pallet loads and offer protection for light-sensitive items.

- Also used as container liners and machinery covers.
- UVI Opaque liners protect products up to 1 year in direct sunlight.

### 2 MIL

MODEL NO.	FITS PALLET L x W x H	COVER SIZE W x D x H	BAGS/ROLL	LBS./ROLL	PRICE PER ROLL		
					1	2	5+
S-7523	42 x 42 x 47"	46 x 42 x 68"	50	41	\$144	\$130	\$116
S-11172	48 x 36 x 80"	48 x 40 x 100"	50	59	208	193	172
S-13558	48 x 40 x 27"	48 x 42 x 48"	50	38	95	88	78
S-13559	48 x 40 x 49"	48 x 46 x 72"	50	46	147	138	124
S-13560	48 x 48 x 48"	51 x 49 x 73"	50	48	160	148	131
S-7524	48 x 40 x 54"	54 x 44 x 76"	50	51	176	160	142
S-7525	48 x 40 x 68"	54 x 44 x 96"	50	64	223	202	180

### 3 MIL

MODEL NO.	FITS PALLET L x W x H	COVER SIZE W x D x H	BAGS/ROLL	LBS./ROLL	PRICE PER ROLL		
					1	2	5+
S-7526	48 x 34 x 54"	48 x 36 x 72"	50	62	\$219	\$198	\$177
■S-12522	48 x 36 x 28"	48 x 40 x 48"	50	48	163	148	142
S-7527	48 x 40 x 27"	48 x 42 x 48"	50	44	155	139	126
S-7528	48 x 40 x 45"	48 x 42 x 66"	50	61	212	191	170
■S-12523	48 x 40 x 49"	48 x 46 x 72"	50	71	267	240	228
S-12524	48 x 40 x 38"	52 x 44 x 60"	50	61	225	204	193
■S-5116	48 x 48 x 48"	51 x 49 x 73"	50	73	260	234	211
■S-5117	48 x 48 x 60"	51 x 49 x 85"	50	85	300	270	243
■S-11173	48 x 48 x 72"	51 x 49 x 97"	50	100	331	299	271
■S-11174	64 x 64 x 49"	68 x 65 x 82"	50	110	362	333	302

• UVI Opaque

■ SHIPS VIA MOTOR FREIGHT

### 1 MIL

MODEL NO.	FITS PALLET L x W x H	COVER SIZE W x D x H	BAGS/ROLL	LBS./ROLL	PRICE PER ROLL		
					1	2	5+
S-12479	36 x 24 x 51"	36 x 27 x 65"	100	34	\$95	\$83	\$76
S-12480	48 x 36 x 80"	48 x 40 x 100"	100	63	193	176	159
S-13538*	48 x 40 x 27"	48 x 42 x 48"	150	46	140	127	114
S-13539	48 x 40 x 45"	48 x 42 x 66"	150	52	190	175	161
S-12481*	48 x 40 x 49"	48 x 46 x 72"	100	50	150	134	124
S-13540*	48 x 40 x 72"	48 x 48 x 96"	100	58	196	182	166
S-13541	48 x 48 x 51"	51 x 48 x 75"	100	53	160	144	134
S-12482	48 x 42 x 74"	54 x 44 x 96"	100	68	205	187	167
S-13542	48 x 48 x 34"	54 x 52 x 60"	100	59	134	124	113

### 2 MIL

S-11091	24 x 24 x 58"	32 x 28 x 72"	100	63	\$193	\$182	\$175
S-6646	36 x 24 x 31"	36 x 24 x 43"	100	36	132	122	112
S-7538	36 x 24 x 60"	40 x 24 x 72"	50	36	96	86	78
S-5357	36 x 24 x 40"	41 x 31 x 56"	50	33	85	74	69
S-7539	36 x 24 x 56"	42 x 32 x 72"	50	37	108	99	88
S-13543	42 x 36 x 51"	42 x 42 x 72"	50	40	124	112	102
S-13544	42 x 36 x 75"	42 x 42 x 96"	50	47	164	146	134
S-12483	42 x 36 x 78"	44 x 36 x 96"	50	57	158	138	127
S-7540	42 x 36 x 47"	46 x 36 x 65"	50	37	108	99	88
S-7519	42 x 40 x 58"	46 x 44 x 80"	50	49	147	131	122
S-6566	48 x 36 x 54"	48 x 36 x 72"	50	41	132	122	107
S-11092	48 x 36 x 62"	48 x 36 x 80"	50	52	143	130	118
S-5842	48 x 36 x 80"	48 x 40 x 100"	50	66	154	139	130
S-13545	48 x 40 x 27"	48 x 42 x 48"	75	41	137	124	111
S-5358	48 x 40 x 45"	48 x 42 x 66"	50	46	143	128	116
S-6700*	48 x 40 x 49"	48 x 46 x 72"	50	49	159	145	134
S-11106	48 x 40 x 73"	48 x 46 x 96"	50	68	176	161	153
S-13546	48 x 40 x 48"	48 x 48 x 72"	50	50	169	159	146
S-13547	48 x 40 x 72"	48 x 48 x 96"	50	58	188	175	164
S-12484	48 x 40 x 74"	52 x 44 x 96"	50	68	168	152	140
S-6701	48 x 40 x 72"	52 x 48 x 96"	50	69	170	154	143
S-13548	48 x 40 x 38"	54 x 44 x 60"	50	51	124	112	102
S-6567	48 x 40 x 50"	54 x 44 x 72"	50	55	162	150	137
S-7520	48 x 40 x 74"	54 x 44 x 96"	50	69	191	172	155
■S-14473	48 x 40 x 98"	54 x 44 x 120"	50	83	243	219	196
S-5359	48 x 40 x 54"	58 x 43 x 76"	50	60	182	155	148
S-12485	48 x 48 x 48"	51 x 49 x 73"	50	55	175	152	144
S-11093	48 x 48 x 60"	51 x 49 x 85"	50	60	188	161	155
■S-11094	58 x 41 x 73"	58 x 46 x 96"	50	78	207	187	179
S-11095	58 x 41 x 66"	58 x 48 x 90"	50	68	196	180	163
■S-5115	64 x 64 x 49"	68 x 65 x 82"	50	73	270	245	219

### 3 MIL

S-3289	24 x 24 x 36"	26 x 24 x 48"	50	25	\$72	\$64	\$59
S-11096	24 x 24 x 35"	30 x 26 x 48"	50	32	86	79	71
S-6568	36 x 24 x 38"	36 x 28 x 52"	50	38	100	90	81
S-2757	48 x 34 x 43"	48 x 34 x 60"	50	53	161	146	130
S-2762	48 x 34 x 54"	48 x 36 x 72"	50	67	196	179	160
■S-11097*	48 x 36 x 52"	48 x 40 x 72"	50	72	209	188	170
S-6569	48 x 40 x 27"	48 x 42 x 48"	50	46	160	144	129
S-7521	48 x 40 x 45"	48 x 42 x 66"	50	61	181	161	146
■S-5843	48 x 40 x 63"	50 x 46 x 86"	50	82	253	235	217
■S-5113	48 x 40 x 66"	52 x 44 x 90"	50	87	258	234	208
■S-3541	48 x 40 x 68"	52 x 44 x 96"	50	94	273	248	218
■S-3290	48 x 40 x 50"	54 x 44 x 72"	50	71	217	195	175
■S-11099	48 x 40 x 68"	54 x 44 x 96"	50	105	293	260	242
■S-8367	48 x 40 x 60"	58 x 40 x 80"	50	86	240	211	193

■ SHIPS VIA MOTOR FREIGHT



BAGS WORK WELL AS MACHINERY COVERS

**IN STOCK – SHIPS TODAY**

Keep warehouse dust and dirt off your products.

- Pre-cut gusseted bags are ideal for use as container liners or pallet and machinery covers.
- Perforated on a roll for easy dispensing. Linear low density poly.



BAGS WORK WELL AS GAYLORD LINERS

#### BIN LINERS:

\* Sizes recommended for bin liners:  
S-13538, S-12481, S-13540, S-6700 and S-11097.

# CLOTH SHIPPING BAGS



**PARTS BAGS**



**MAILING BAGS**

Pack and ship small parts, hardware and samples economically. Sturdy, dependable cotton.

**PARTS BAGS** – Keep small parts, nuts and bolts together. Tie to larger parts of shipment.

**MAILING BAGS** – Mail samples in bag with sewn-in, postage-ready address tag.

**DELUXE PARTS BAGS** – See [uline.com](http://uline.com) for more information.

MODEL NO.	SIZE W x L	BAG TYPE	PRICE EACH (MIN. ORDER 200)			
			200	500	1,000	3,000+
S-17831	2 x 3"	Parts Bags	\$.16	\$.15	\$.14	\$.13
S-870	3 x 4"		.19	.18	.17	.15
S-871	3 x 5"		.20	.19	.18	.16
S-872	4 x 6"		.23	.22	.21	.19
S-1164	5 x 7"		.28	.27	.25	.22
S-873	5 x 8"		.30	.29	.27	.25
S-874	6 x 8"		.35	.33	.31	.29
S-1165	6 x 10"		.41	.39	.35	.33
S-875	8 x 10"		.57	.55	.50	.47
S-876	8 x 12"		.58	.56	.51	.48
S-17832	8 x 14"		.72	.70	.64	.59
S-2726	8 x 16"		.99	.95	.89	.82
S-2727	12 x 16"		1.35	1.32	1.23	1.13
S-17833	12 x 20"		1.70	1.66	1.54	1.42
S-1070	3 x 5"	Mailing Bags	.27	.26	.24	.21
S-880	4 x 6"		.32	.31	.28	.26
S-881	5 x 7"		.37	.35	.33	.31
S-3024	5 x 8"		.42	.40	.37	.34
S-3025	6 x 8"		.46	.44	.42	.40
S-1988	6 x 10"		.50	.48	.46	.43
S-883	8 x 12"		.61	.59	.56	.51
S-17834	12 x 16"		1.54	1.49	1.38	1.27

# ICE CUBE BAGS



Preprinted ice bags resist temperatures to -20°F.

- "EVA" additive increases strength and puncture resistance.
- Drawstring Bags – Quick closure, no need for ties.
- FDA/USDA compliant.

## BAGS

MODEL NO.	SIZE W x L x D	ICE CAPACITY	MIL	PRICE PER CARTON			QTY./ CTN.
				1	2	5+	
S-7327	9 x 17 x 4"	5 lbs.	1.5	\$94	\$89	\$87	1,000
S-7328	11 x 19 x 3½"	8 lbs.	1.5	120	115	111	1,000
S-7329	12 x 19 x 3½"	10 lbs.	1.7	130	126	120	1,000
S-9956	14 x 26 x 4"	20 lbs.	2.25	150	143	137	500
S-12513	18 x 36 x 4"	50 lbs.	3.0	173	166	160	250

## DRAWSTRING BAGS

MODEL NO.	SIZE W x L x D	ICE CAPACITY	MIL	PRICE PER CARTON			QTY./ CTN.
				1	2	5+	
S-17835	9 x 17 x 4"	5 lbs.	1.5	\$134	\$129	\$124	500
S-16467	11 x 19 x 3½"	8 lbs.	1.5	149	143	137	500
S-16468	12 x 19 x 3½"	10 lbs.	1.7	167	159	152	500
S-16469	14 x 26 x 4"	20 lbs.	2.25	130	126	121	250
S-17836	18 x 36 x 4"	50 lbs.	3.0	217	207	198	250



# HOG RING PLIER STAPLER

Cinch bags with one quick motion.

- Galvanized, rust-free staples.

**FREE HOG RING STAPLER AND STAPLES**  
Upon request with any Ice Cube Bag order of \$500 or more.

\* Not for use with 50 lb. bags

MODEL NO.	DESCRIPTION	PRICE EACH		QTY./ CTN.
		1	2+	
H-1481*	Hog Ring Plier Stapler	\$57	\$55	1
S-12548	11/16" Hog Ring Staples	\$14 ctn. 3+/\$13 ctn.		2,500



# BULK BAGS

**SPOUT TOP, SPOUT BOTTOM** – For fine powders and resins.

MODEL NO.	SIZE W x L x D	CU. FT.	QTY./ SKID	PRICE EACH			SKID LOT	
				1	10	20+		
S-20563	35 x 35 x 40"	35		\$32	\$28	\$25	\$18	
S-19912	35 x 35 x 50"	45		56	36	32	29	21
S-20564	35 x 35 x 55"	50		38	34	31	22	

**DUFFLE TOP, PLAIN BOTTOM** – For scrap and large parts. \* Baffled

MODEL NO.	SIZE W x L x D	CU. FT.	QTY./ SKID	PRICE EACH			SKID LOT
				1	10	20+	
S-22712	35 x 35 x 35"	30	64	\$29	\$28	\$25	\$17
S-20565	35 x 35 x 40"	35	56	32	28	25	18
S-22713	35 x 35 x 45"	40	56	35	31	28	20
S-19913	35 x 35 x 55"	50	56	37	33	30	21
S-22714*	42 x 42 x 55"	70	40	42	39	36	24

**DUFFLE TOP, SPOUT BOTTOM** – For gravel and landscaping stones. \* Baffled

MODEL NO.	SIZE W x L x D	CU. FT.	QTY./ SKID	PRICE EACH			SKID LOT
				1	10	20+	
S-20566	35 x 35 x 35"	30	64	\$32	\$28	\$25	\$18
S-13642	35 x 35 x 40"	35	56	35	31	28	20
S-22715	35 x 35 x 45"	40	56	37	33	30	21
S-22716	35 x 35 x 50"	45	56	38	34	31	22
S-13643	35 x 35 x 55"	50	56	40	36	33	23
S-19914	35 x 35 x 60"	55	56	42	38	35	24
S-13644*	42 x 42 x 44"	55	40	45	41	38	27
S-19915*	42 x 42 x 55"	70	40	48	44	41	29

**DUFFLE TOP, SPOUT BOTTOM, POLY LINED** – For seeds, nuts and grains.

MODEL NO.	SIZE W x L x D	CU. FT.	QTY./ SKID	PRICE EACH			SKID LOT
				1	10	20+	
S-19916	35 x 35 x 40"	35	56	\$39	\$35	\$32	\$23
S-23458	35 x 35 x 55"	50	38	43	39	36	26



**HOLDS UP TO 3,000 LBS.**

Haul heavy loads of powders, resins and grains.

- 4 heavy duty corner straps – Forkliftable.
- Woven polypropylene resists UV and water.
- Collapsible for easy storage. • FDA compliant.

**S-19916 and S-23458** – 3 mil poly liners protect against moisture and contamination.

**S-22714, S-13644 and S-19915** – Corner baffles keep bag square for easy stacking.

- Bulk Bag Lifter, see [uline.com](http://uline.com)

**SKID LOTS – SAVE UP TO 45%**

# WOVEN POLY TARPS

**5 MIL BLUE** – Grommets 36-40" apart.

MODEL NO.	SIZE W x L	LBS. EACH	PRICE EACH			
			1	2	4	10+
S-3886	16 x 20'	5	\$19	\$18	\$17	\$16
S-5128	20 x 30'	9	35	33	31	29
S-8399	20 x 40'	11	45	43	40	38
S-5129	30 x 40'	16	61	59	56	53
S-8400	30 x 50'	20	74	71	68	64
S-23460	40 x 40'	22	92	87	83	77
S-8401	40 x 60'	30	116	112	107	102
S-23461	60 x 60'	50	169	163	158	152

**12 MIL HEAVY DUTY** – Grommets 16-20" apart.

MODEL NO.	SIZE W x L	LBS. EACH	PRICE EACH			
			1	2	4	10+
S-20569	12 x 20'	10	\$52	\$49	\$45	\$41
S-19992	16 x 20'	13	63	59	56	52
S-22717	20 x 20'	16	81	76	70	65
S-19993	20 x 30'	24	108	102	95	89
S-20570	20 x 40'	31	144	137	131	124
S-22718	30 x 50'	58	275	265	254	243
S-19994	40 x 60'	96	395	378	361	343



Shield equipment or skids during storage or natural disasters.

- Provide shade protection or ground cover.
- Both sides laminated. Plastic reinforced corners.

**5 Mil Blue** – Lightweight, polyethylene-coated tarps stand up to water, wind and sun.

**12 Mil Heavy Duty** – Super thick, UV-treated poly with rope-reinforced hems for rugged all-weather use. Reflective silver on one side, black on the other.

# SANDBAGS



Package heavy parts and supplies or use as sand-filled flood barriers.

- Woven polypropylene resists punctures and tears.
- Maximum UVI protection – Lasts 1,600 hours in the sun.
- Dense, tight weave holds almost any dry substance.
- Hi-vis orange and yellow bags for highway barricades and outdoor use.
- Green suitable for military applications.



SPECIFY COLOR: Yellow, Orange, Green, White, Tan\* or Black\*

MODEL NO.	SIZE W x L	CAPACITY (LBS.)	LBS./ BNDL.	PRICE PER BUNDLE			QTY./ BNDL.
				1	5	10+	
S-15518	10 x 14"	15	5	\$33	\$31	\$29	
S-11052	12 x 20"	25	7	43	41	37	
S-13896▲	12 x 38"	90	13	63	59	55	100
S-8419*	14 x 26"	50	10	\$42 per bndl. any qty.			
S-14490	18 x 24"	60	12	57	52	49	

MODEL NO.	SIZE W x L	CAPACITY (LBS.)	LBS./ BNDL.	PRICE PER BUNDLE			QTY./ BNDL.
				1	5	10+	
S-8420	18 x 30"	75	16	\$71	\$65	\$61	
S-8421	20 x 36"	100	20	81	76	71	
S-16504	24 x 40"	125	27	107	101	93	100
S-17705	30 x 36"	150	29	121	113	105	
S-17706	36 x 48"	175	46	193	180	166	

\*Also available in Tan and Black

▲Only available in White

# SANDLESS SANDBAGS



Stop flooding in workshops, garages and basements.

- Self-activating bags expand on contact with water. No sand needed.
- Each bag absorbs 4 gallons, swelling to 3½" high.
- Shrinks down when fully dry.

REUSABLE

MODEL NO.	SIZE W x L	QTY./ PKG.	CAPACITY (LBS.)	LBS./ PKG.	PRICE PER PACKAGE		
					1	5	10+
S-20560	12 x 24"	6	32	5	\$49	\$47	\$44

# BARRIERS IN A BUCKET



Emergency flood control for doorways and garages.

- 10-ft. long barriers each absorb 8 gallons. Can be stacked to form a wall.
- Self-activating barrier expands to 3½" high.
- Easy to store and transport.

REUSABLE

MODEL NO.	SIZE W x L	QTY./ BKT.	CAPACITY (LBS.)	LBS./ BKT.	PRICE PER BUCKET		
					1	3	6+
S-22722	6" x 10'	5	68	15	\$165	\$160	\$155



# MESH BAGS

Package onions, potatoes, fruits and firewood.

- Quick closure. Just cinch up draw tape and tie.
- UV-resistant woven polypropylene.

MODEL NO.	SIZE W x L	CAPACITY (LBS.)	LBS./ BNDL.	PRICE PER BUNDLE			QTY./ BNDL.
				1	5	10+	
S-14435	22 x 18"		12	\$72	\$70	\$68	
S-14436	22 x 24"	50	14	86	83	80	100
S-14437	21 x 32"		17	104	102	99	

# STAINLESS STEEL SCOOPS



Scoop powders, dry grains and bulk ingredients.

- Type 304 stainless steel. Resists rust and corrosion.
- Additional Scoops available, see [uline.com](http://uline.com)

Dishwasher safe. NSF certified.

MODEL NO.	DESCRIPTION	CAPACITY	PRICE EACH	
			1	3+
H-7428		16 oz.	\$71	\$66
H-4869	Stainless Steel	32 oz.	76	70
H-4870		64 oz.	82	75

# BURLAP ROLLS AND SQUARES

## ROLLS

MODEL NO.	SIZE W x L	RECOMMENDED USE	LBS./ROLL	PRICE PER ROLL		
				1	3	5+
S-17710	4" x 100 yds.	Tree Wrap	6	\$30	\$28	\$26
S-15519	8" x 100 yds.		13	55	51	47
S-14512	12" x 100 yds.		18	71	67	62
S-20523	16" x 100 yds.		23	87	81	75
S-14513	20" x 100 yds.	Landscaping	28	102	95	86
S-19805	24" x 100 yds.		34	129	121	110
S-15520	30" x 100 yds.		42	161	149	137
S-11055	36" x 100 yds.		49	180	167	152
S-15521	40" x 100 yds.	Agricultural	54	198	185	168
S-13899	48" x 100 yds.		68	214	200	183
S-20524	54" x 50 yds.		38	120	112	102
S-14514	60" x 50 yds.		42	132	123	112
S-13900	72" x 50 yds.	Construction	49	180	167	152
S-19806	96" x 50 yds.		64	255	237	221

■ SHIPS VIA MOTOR FREIGHT



Recommended for tree wrapping, landscaping and construction.

- Absorbs moisture while allowing airflow. 10 oz. natural fibers.

**Rolls** – Extended lengths for large-scale landscaping projects.

**Squares** – Large pre-cut sizes used to protect plants and roots.

## SQUARES

MODEL NO.	SIZE W x L	FABRIC WEIGHT	LBS./BNDL.	PRICE PER BUNDLE			QTY./BNDL.
				1	5	10+	
S-20520	48 x 48"	10 oz.	44	\$126	\$121	\$114	50
S-20521	60 x 60"		34	98	92	87	25
S-20522	80 x 80"		49	121	114	109	20

# BURLAP BAGS

## BAGS

MODEL NO.	SIZE W x L	FABRIC WEIGHT	LBS./BNDL.	PRICE PER BUNDLE			QTY./BNDL.
				1	5	10+	
S-15522	4 x 6"	10 oz.	6	\$28	\$26	\$25	100
S-15523	6 x 10"		8	38	36	34	
S-8422	8 x 12"		12	46	43	41	
S-14515	10 x 14"		16	54	51	48	
S-8423	12 x 20"		27	77	74	68	
S-8424	14 x 26"		35	110	103	97	
S-8425	18 x 24"		40	126	119	111	
S-11053	18 x 30"	48	140	131	123		
S-19802	20 x 24"	10 oz.	22	84	79	74	50
S-12332	20 x 36"		27	96	91	85	
S-16508	22 x 36"		30	102	96	90	
S-11054	23 x 40"		30	112	106	99	
S-16509	24 x 36"		31	109	102	96	
S-14516	26 x 40"		32	130	122	114	
S-14517	34 x 40"		36	161	152	141	
S-15524	36 x 48"	51	204	191	179		
S-16510	48 x 60"	10 oz.	32	168	156	147	25
S-17709	48 x 72"		49	208	196	182	



Ship and store metal parts and hardware.

- Absorbs moisture, oil and grease while allowing airflow.
- Strong 10 oz. natural fibers. Biodegradable.

## BAGS WITH DRAWSTRING

MODEL NO.	SIZE W x L	FABRIC WEIGHT	LBS./BNDL.	PRICE PER BUNDLE			QTY./BNDL.
				1	5	10+	
S-19803	2 x 3"	10 oz.	2	\$20	\$19	\$17	100
S-19804	3 x 5"		4	23	22	20	
S-13897	4 x 6"		6	30	29	27	
S-13898	6 x 10"		8	42	39	37	
S-15525	8 x 12"		12	50	48	45	
S-15526	10 x 14"		16	59	55	51	
S-16505	12 x 20"		27	82	78	74	
S-17707	14 x 26"		31	114	108	101	
S-17708	18 x 24"	36	132	125	117		



# COLORED BURLAP BAGS

Huge variety of Favor Bags, see page 181.

Rustic favor bags are popular at outdoor weddings and summer picnics.

- Natural jute fibers.
- Sturdy cotton cord drawstring.

SPECIFY COLOR: ■ Red ■ Black ■ Moss ■ Ivory

MODEL NO.	SIZE W x L	FABRIC WEIGHT	LBS./BNDL.	PRICE PER BUNDLE			QTY./BNDL.
				1	5	10+	
S-20525	4 x 6"	10 oz.	6	\$61	\$57	\$54	100
S-20526	6 x 10"		8	91	87	83	





# BLACK POLY SHEETING

Protect and conceal your product. Use in construction, masonry and landscaping.

- Heavy duty opaque plastic sheeting. Quality low-density film on a continuous roll.

## 4 MIL BLACK

MODEL NO.	SIZE W x L	PRICE PER ROLL			LBS./ ROLL
		1	2	4+	
S-14633	6 x 100'	\$37	\$35	\$34	13
S-13638	8 x 100'	47	46	43	16
S-11182	10 x 100'	54	51	49	21
S-13639	12 x 100'	69	65	63	25
S-14634	16 x 100'	89	87	82	33
S-11183	20 x 100'	103	100	95	40
S-14635	24 x 100'	124	121	116	48

## 6 MIL BLACK

MODEL NO.	SIZE W x L	PRICE PER ROLL			LBS./ ROLL
		1	2	4+	
S-14636	6 x 100'	\$50	\$48	\$47	18
S-13640	8 x 100'	69	64	63	24
S-11184	10 x 100'	80	78	75	31
S-13641	12 x 100'	96	93	89	36
S-14637	16 x 100'	131	124	121	48
S-11185	20 x 100'	162	155	148	60
S-14638	24 x 100'	201	193	185	69

# CANVAS DROP CLOTHS



Cover and protect floors, furnishings or equipment.

- Heavyweight 8-oz. fabric absorbs spills.
- Double-stitched hems and seams.
- Washable and reusable.

MODEL NO.	DESCRIPTION	SIZE W x L	PRICE EACH			LBS. EACH
			1	6	12+	
S-20567	Canvas	9 x 12'	\$28	\$26	\$24	7
S-20568		12 x 15'	44	41	38	10

# NON-SLIP DROP CLOTHS

Slip-resistant safety drop cloth stays put on smooth, slick surfaces.

- Leakproof protection against all paints and stains.
- Durable, grippy rubber backing.
- Reusable. Wipes clean.



MODEL NO.	DESCRIPTION	SIZE W x L	PRICE EACH			LBS. EACH
			1	6	12+	
S-22791	Rubber-Backed	4 x 15'	\$29	\$27	\$25	4
S-22792		9 x 12'	45	42	39	8

# ZIPWALL® SYSTEM



Zipper - Create an instant doorway to provide easy entry and exit.

Build a dust barrier in minutes.

- Use with Poly Sheeting rolls 1' wider than ceiling height.
- 4 spring-loaded poles for fast, easy setup.
- Includes 2 standard zippers, 2 flap hooks, 4 grip disks and carrying bag.

## ZIPWALL® SYSTEM

MODEL NO.	DESCRIPTION	POLE HEIGHT	PRICE PER KIT		
			1	2	4+
H-7880	Zipwall® System	12'	\$329	\$319	\$309

## ZIPPERS

MODEL NO.	DESCRIPTION	SIZE W x H	QTY./ BOX	PRICE PER BOX	
				1	3+
S-22875	Standard	2" x 7'	2	\$20	\$18
S-22876	Heavy Duty	3" x 7'		28	26



# FIRE RETARDANT POLY SHEETING

Flame-retardant protection that pleases fire marshals.

- Construct vapor barriers between drywall and insulation or under floors.

**Reinforced** - Tough scrim protects against tears and punctures.

## 6 MIL STANDARD

Meets or exceeds NFPA 701 test, method 2

MODEL NO.	SIZE W x L	PRICE PER ROLL			LBS./ ROLL
		1	2	4+	
S-22877	8 x 100'	\$99	\$95	\$91	24
S-22878	12 x 100'	135	130	125	36
S-20069	20 x 100'	195	190	185	60

## 6 MIL REINFORCED

Meets or exceeds NFPA 701 test, method 2

S-22879	8 x 100'	\$116	\$112	\$108	16
S-22880	12 x 100'	160	155	150	23
S-20070	20 x 100'	255	245	235	40

# POLY SHEETING

## 1 MIL

MODEL NO.	SIZE W x L	PRICE PER ROLL			LBS./ ROLL
		1	2	4+	
S-14628	9 x 400'	\$60	\$58	\$55	19
S-14629	12 x 400'	81	78	72	25
S-20063	20 x 400'	137	128	121	40

## 2 MIL

S-20064	3 x 200'	\$18	\$17	\$16	6
S-5444	4 x 200'	25	24	23	8
S-20065	6 x 200'	37	35	33	13
S-5445	8 x 200'	46	45	42	16
S-14630	10 x 200'	58	55	51	20
S-5446	12 x 200'	66	64	60	25
S-5447	16 x 200'	85	82	79	33
S-13635	20 x 200'	108	105	98	40

## 2 MIL DISPENSER BOX

S-5455	10 x 100'	\$33	\$32	\$30	10
--------	-----------	------	------	------	----

## 4 MIL

S-11175	3 x 100'	\$24	\$23	\$22	7
S-5130	4 x 100'	\$24 per roll any quantity			10
S-20066	5 x 100'	32	30	29	11
S-5131	6 x 100'	33	32	30	13
S-5132	8 x 100'	42	41	39	16
S-5133	10 x 100'	\$45 per roll any quantity			21
S-5134	12 x 100'	62	59	57	25
S-13636	14 x 100'	71	69	65	29
S-5135	16 x 100'	79	76	72	33
S-5136	20 x 100'	91	88	85	40
S-5853	24 x 100'	110	107	103	48
S-11176	32 x 100'	168	163	159	64
■ S-17860	40 x 100'	221	215	208	81

■ SHIPS VIA MOTOR FREIGHT



CONTINUOUS ROLL

Economical protection from dust, dirt and moisture.

- Covers warehouse equipment, machinery, construction materials and skids.
- Replaces expensive drop cloths.
- Giant sheeting ideal cover for lumber, walls, scaffolding.
- Painter's Plastic – Surface protection for indoor painting projects. 1 mil.

## 6 MIL

MODEL NO.	SIZE W x L	PRICE PER ROLL			LBS./ ROLL
		1	2	4+	
S-20067	1 x 500'	\$49	\$47	\$45	16
S-22860	3 x 100'	30	28	27	10
S-13637	4 x 100'	40	38	37	13
S-14631	6 x 100'	46	45	42	18
S-11177	8 x 100'	62	59	57	24
S-11178	10 x 100'	71	69	66	31
S-11179	12 x 100'	86	83	80	36
S-14632	16 x 100'	116	113	108	48
S-11180	20 x 100'	144	139	132	60
S-11181	24 x 100'	171	166	160	69
■ S-17861	32 x 100'	250	242	232	96
■ S-17862	40 x 100'	322	311	299	119

■ SHIPS VIA MOTOR FREIGHT

# REINFORCED POLY SHEETING

## 6 MIL

MODEL NO.	SIZE W x L	PRICE PER ROLL			LBS./ ROLL
		1	2	4+	
S-17863	8 x 100'	\$84	\$82	\$77	22
S-17864	10 x 100'	102	99	95	26
S-20068	12 x 100'	111	107	103	30
S-17865	20 x 100'	196	190	183	44
S-22861	24 x 100'	244	233	223	51
S-22862	32 x 100'	318	307	297	66
■ S-17866	40 x 100'	377	365	352	80

■ SHIPS VIA MOTOR FREIGHT

## 10 MIL HEAVY DUTY

S-22892	12 x 50'	\$175	\$167	\$159	33
S-22893	20 x 50'	286	276	265	49

## CONTINUOUS ROLL

Protect against rain, snow and gusty Nebraska winds.

- Create temporary walls, enclose construction sites or cover temporary windows.
- Waterproof, rot-proof and chemical resistant.
- Reinforced scrim stops punctures and tears.



# HEAVY DUTY POLY TUBING



## HEAVY DUTY POLY TUBING

**IN STOCK - SHIPS TODAY**

### 3 MIL

MEETS MIL. SPEC. A-A-3174

MODEL NO.	ROLL SIZE	LBS./ROLL	PRICE PER ROLL			
			1	2	6	12+
S-5864	2" x 1,500'	8	\$39	\$38	\$35	\$33
S-13501	3" x 1,500'	13	51	49	45	42
S-5522	4" x 1,500'	16	62	59	56	51
S-14493	5" x 1,500'	18	74	70	65	62
S-5523	6" x 1,500'	22	83	79	74	69
S-5524	8" x 1,500'	29	104	98	93	88
S-5865	10" x 1,500'	35	127	120	113	105
S-5525	12" x 1,500'	44	152	145	135	127
S-5866	14" x 1,500'	50	179	168	159	148
S-13502	16" x 1,000'	42	170	160	151	143
S-11123	18" x 1,000'	45	177	167	158	148
S-13503	20" x 1,000'	52	187	177	166	155
S-11124	24" x 1,000'	59	207	194	183	171
S-14494	36" x 750'	65	208	196	185	174

### 6 MIL

Popular heavy-duty thickness.

S-2940	2" x 1,000'	12	\$53	\$50	\$47	\$43
S-3517	3" x 1,000'	16	66	63	59	56
S-1658	4" x 1,000'	20	82	76	72	67
S-2941	5" x 1,000'	25	93	88	83	79
S-1659	6" x 1,000'	29	111	104	98	91
S-3661	7" x 1,000'	34	134	127	120	112
S-1660	8" x 1,000'	39	140	131	123	116
S-13504	9" x 1,000'	43	158	148	142	131
S-2239	10" x 1,000'	49	176	166	155	147
S-1661	12" x 1,000'	58	202	190	179	167
S-2395	14" x 500'	36	118	111	103	97
S-2942	16" x 500'	39	134	127	120	112
S-3518	18" x 500'	48	146	137	129	121
S-11125	20" x 500'	51	154	147	138	129
S-3519	24" x 500'	58	192	182	171	160
S-14495	30" x 400'	58	180	170	160	150
S-7921	36" x 300'	53	162	153	145	135
S-7922	48" x 250'	63	184	174	162	152

MEETS MIL. SPEC. A-A-3174



## BLACK HEAVY DUTY POLY TUBING

Low density poly recommended for light-sensitive products.

### BLACK 4 MIL

MODEL NO.	ROLL SIZE	LBS./ROLL	PRICE PER ROLL			
			1	2	6	12+
S-14496	4" x 1,500'	19	\$82	\$76	\$72	\$67
S-7923	6" x 1,500'	29	120	113	105	99
S-7924	8" x 1,500'	39	150	144	134	126
S-14497	10" x 1,500'	48	208	196	185	174
S-7925	12" x 1,500'	58	224	211	200	187
S-11126	16" x 750'	39	146	137	129	121
S-11129	18" x 750'	47	153	146	137	128
S-14498	24" x 750'	58	193	183	172	161

### BLACK 6 MIL

S-11127	2" x 1,000'	10	\$60	\$57	\$55	\$50
S-5526	4" x 1,000'	20	85	81	75	70
S-5527	6" x 1,000'	29	120	113	105	99
S-5528	8" x 1,000'	39	150	144	134	126
S-14499	10" x 1,000'	48	208	196	185	174
S-5529	12" x 1,000'	58	224	211	200	187
S-6525	14" x 500'	36	150	144	134	126
S-11128	16" x 500'	39	154	147	138	129
S-7926	24" x 500'	58	194	185	174	162



## DISPENSERS

- Wall, bench or tabletop mount.
- 1" core fits all tubing.

MODEL NO.	HOLDS WIDTH UP TO	PRICE EACH		
		1	2	6+
H-28	12" Roll	\$20	\$19	\$18
H-29	24" Roll	27	25	23
H-918	36" Roll	34	32	29
H-1243	48" Roll	50	46	42



## POLY TUBING SEALERS

**WITH BUILT-IN CUTTER**

**SPECIAL OFFER**

- Save \$50 upon request when you order \$200 of poly tubing.

MODEL NO.	SEALING SIZE L x W	PRICE EACH	
		REG. PRICE	SPECIAL
H-940	8 x 1/16"	<del>\$134</del>	\$84
H-920	12 x 1/16"	<del>175</del>	125



# POLY TUBING

SHIPS TODAY

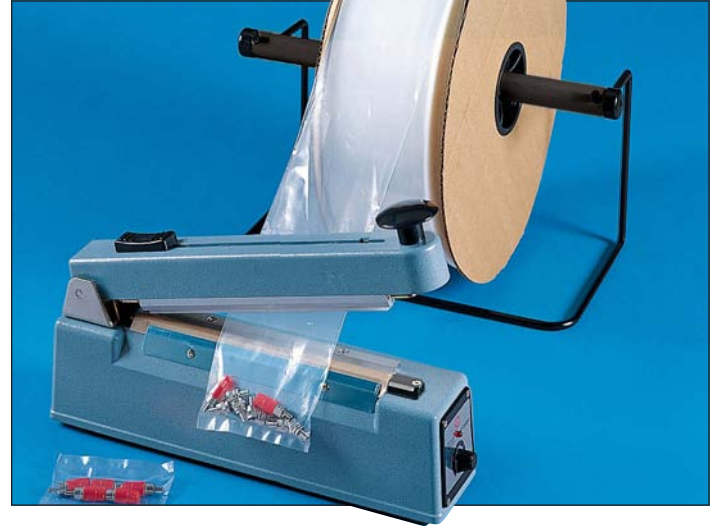

Need special size bags for odd-shaped or extra-large products? Just cut the length you need, insert your product and seal the ends for a custom fit every time. Roll converts from 1" to 3" core.

- Eliminates the need to stock an expensive variety of bags.
- All-virgin film meets FDA and USDA specifications.

2 MIL			MEETS MIL. SPEC. A-A-3174			
MODEL NO.	ROLL SIZE	LBS./ROLL	PRICE PER ROLL			
			1	2	6	12+
S-3520	1" x 1,500'	4	\$20	\$19	\$18	\$17
S-3521	1½" x 1,500'	5	24	23	22	21
S-1112	2" x 3,000'	12	54	50	47	43
S-3657	2½" x 3,000'	14	60	57	55	50
S-1113	3" x 3,000'	16	66	63	59	56
S-1114	4" x 3,000'	20	82	76	72	67
S-2387	5" x 3,000'	24	93	88	83	79
S-1115	6" x 3,000'	31	111	104	98	91
S-2388	7" x 3,000'	36	126	119	112	104
S-1116	8" x 3,000'	37	140	131	123	116
S-2389	9" x 3,000'	44	158	148	142	131
S-1117	10" x 3,000'	45	176	166	155	147
S-3658	11" x 3,000'	54	192	182	171	160
S-1118	12" x 3,000'	56	202	190	179	167
S-19807	13" x 1,500'	33	109	103	96	89
S-1984	14" x 1,500'	35	118	111	103	97
S-1119	16" x 1,500'	39	134	127	120	112
S-1985	18" x 1,500'	43	146	137	129	121
S-1123	20" x 1,500'	48	160	150	143	132
S-2390	22" x 1,500'	53	176	166	155	147
S-1124	24" x 1,500'	59	192	182	171	160
S-3522	26" x 1,500'	63	200	188	177	166
S-5493	28" x 1,500'	68	215	204	192	180
S-5494	30" x 750'	38	138	129	122	114
S-19808	32" x 750'	40	143	132	126	118
S-3659	36" x 750'	42	150	144	134	126
S-14492	40" x 500'	32	118	111	103	97
S-11157	48" x 450'	38	134	127	120	112

4 MIL			MEETS MIL. SPEC. A-A-3174			
MODEL NO.	ROLL SIZE	LBS./ROLL	PRICE PER ROLL			
			1	2	6	12+
S-11155	1" x 750'	4	\$23	\$22	\$21	\$19
S-15162	1½" x 750'	5	25	24	23	22
S-1141	2" x 1,500'	11	53	50	47	43
S-15163	2½" x 1,500'	13	60	57	55	50
S-1142	3" x 1,500'	16	66	63	59	56
S-1143	4" x 1,500'	21	\$67 per roll any quantity			
S-2391	5" x 1,500'	25	93	88	83	79
S-1144	6" x 1,500'	28	111	104	98	91
S-2392	7" x 1,500'	34	126	119	112	104
S-1145	8" x 1,500'	39	140	131	123	116
S-2393	9" x 1,500'	43	158	148	142	131
S-1146	10" x 1,500'	45	176	166	155	147
S-1147	12" x 1,500'	57	202	190	179	167
S-3660	13" x 750'	32	116	108	102	96
S-1986	14" x 750'	35	118	111	103	97
S-1148	16" x 750'	40	134	127	120	112
S-1987	18" x 750'	47	146	137	129	121
S-1153	20" x 750'	49	160	150	143	132
S-2394	22" x 750'	53	176	166	155	147
S-1154	24" x 750'	59	192	182	171	160
S-5495	26" x 750'	63	200	188	177	166
S-5496	28" x 750'	68	215	204	192	180
■S-6520	30" x 750'	73	227	215	203	190
■S-15164	32" x 750'	77	238	224	211	198
■S-3523	36" x 750'	90	257	243	228	214
S-11156	40" x 500'	66	208	195	184	172
■S-5867	48" x 450'	74	219	208	195	184
■S-19809	60" x 400'	76	240	228	216	204

■ SHIPS VIA MOTOR FREIGHT

# Autobag® BAGS



Pre-opened and perforated bags on a roll make packaging quick and easy.

- Special blend of poly provides strength at a lower gauge.
- Low-density poly. • FDA/USDA compliant.

## 1.5 MIL

MODEL NO.	SIZE W x L	MIL	BAGS/ROLL	LBS./ROLL	PRICE PER ROLL		
					1	3	6+
S-16465	3 x 3"	1.5	5,500	5	\$104	\$96	\$90
S-8426	3 x 4"		4,000	6	80	75	68
S-8427	3 x 5"		3,000	6	67	61	57
S-11111	4 x 4"		4,000	6	84	78	71
S-8428	4 x 5"		3,000	8	75	69	63
S-11112	4 x 6"		2,500	6	66	60	55
S-16466	4 x 8"		1,750	6	65	59	54
S-8429	5 x 7"		2,000	9	59	55	50
S-8430	6 x 8"		1,750	9	67	61	57
S-8431	8 x 10"		1,500	15	80	75	68
S-8432	9 x 12½"		1,250	16	93	86	79
S-11113	12 x 14"		1,250	22	172	160	147

## ULINE VACUUM BAGS



Provide excellent barrier protection and lock out moisture.

- Transparent poly nylon vacuum pouches.
- Package food items.
- FDA/USDA compliant.

MODEL NO.	OUTSIDE DIM. W x L	MIL	QTY./CTN.	PRICE PER CARTON		
				1	3	5+
S-14569	5 x 7"	3	1,000	\$40	\$37	\$34
S-7554	6 x 8"			50	46	41
S-12337	6 x 10"			63	58	53
S-14570	6 x 12"			69	65	60
S-15150	6 x 15"			87	81	76
S-15151	7 x 9"			61	56	53
S-15152	7 x 11"			75	69	65
S-7556	8 x 10"			75	69	65
S-7557	8 x 12"			89	84	78

MODEL NO.	OUTSIDE DIM. W x L	MIL	QTY./CTN.	PRICE PER CARTON		
				1	3	5+
S-14571	8 x 15"	3	1,000	\$108	\$102	\$94
S-12338	10 x 10"			92	88	80
S-19799	10 x 12"			108	102	94
S-7558	10 x 13"			116	110	103
S-12339	10 x 15"			135	127	118
S-19800	10 x 18"			171	163	153
S-15153	10 x 22"	3	500	98	92	87
S-16470	10 x 30"			135	125	118
S-15154	12 x 12"			69	65	60
S-14572	12 x 14"			82	77	70
S-7559	12 x 16"			89	84	78
S-11114	12 x 18"			98	92	87
S-14573	14 x 16"			102	95	88
S-12340	14 x 20"			125	118	111
S-16471	14 x 24"			151	142	133
S-11115	16 x 20"			142	134	125
S-14574	16 x 24"			169	158	149
S-14575	18 x 28"	3	250	109	103	95
S-15155	24 x 36"			184	175	165

## VACUUM SEALER

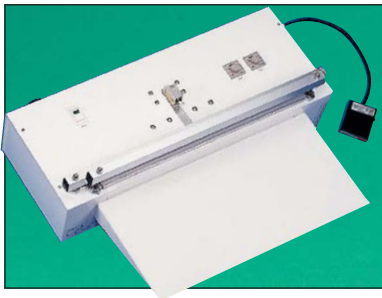

Create an airtight seal.

- Seals vacuum bags, Dri Shield™ bags and metalized poly bags.
- Use with air compressor. Working tray sold separately.

See [uline.com](http://uline.com) for more information

MODEL NO.	DESCRIPTION	SEAL SIZE L x W	SHPG. LBS.	PRICE EACH
H-1075	Sealer	20 x 1/4"	25	\$2,350
H-1076	Working Tray		4	125

## ULINE BAGS ON A ROLL



### WHITE BACK

Label and display parts.

- White opaque back with clear front.

## 2 MIL

MODEL NO.	SIZE W x L	MIL	BAGS/ROLL	LBS./ROLL	PRICE PER ROLL		
					1	3	6+
S-11117	4 x 6"	2	2,000	7	\$68	\$63	\$58
S-11118	6 x 8"		1,500	11	70	66	60
S-11119	8 x 10"		1,250	14	95	89	82
S-11120	9 x 12½"		1,000	16	98	92	84

# ULINE BAGS ON A ROLL

Pre-opened and perforated for easy insertion and tear-off. Ideal for high volume packaging operations.

- Sleeve type bags are open at one end, sealed at the other end.
- All virgin, low density polyethylene film. FDA and USDA compliant.
- Water resistant. • Can be used in Autobag® machines.



CLEAR BAGS ON A ROLL

## 1 MIL

MODEL NO.	SIZE W x L	BAGS/ROLL	LBS./ROLL	PRICE PER ROLL		
				1	3	6+
S-13588	3 x 4"	4,000	6	\$47	\$45	\$43
S-12365	4 x 6"	2,500	8	58	55	51
S-13589	6 x 8"	1,750	10	61	59	55
S-12366	9 x 12"	1,000	12	68	66	62
S-12367	12 x 15"	1,000	17	124	118	112
S-12368	18 x 24"	625	30	203	194	185

## 2 MIL

MODEL NO.	SIZE W x L	BAGS/ROLL	LBS./ROLL	PRICE PER ROLL		
				1	3	6+
S-3772	2 x 3"	4,000	4	\$56	\$54	\$50
S-5449	3 x 3"	4,000	4	60	56	53
S-3305	3 x 4"	3,000	6	47	45	42
S-3027	3 x 5"	2,250	5	39	37	35
S-12369	3 x 8"	1,500	6	50	48	46
S-3028	4 x 4"	3,000	7	54	51	48
S-3029	4 x 5"	2,250	6	47	45	42
S-1262	4 x 6"	2,000	8	47	45	42
S-5878	4 x 8"	1,500	8	51	49	46
S-6526	4 x 12"	1,000	7	46	43	41
S-11116	5 x 5"	2,250	9	58	54	51
S-3031	5 x 7"	1,750	9	62	58	54
S-5450	5 x 8"	1,500	6	55	53	49
S-5451	5 x 10"	1,250	7	48	46	43
S-5452	6 x 6"	2,000	11	66	63	58
S-1263	6 x 8"	1,500	8	56	54	50
S-6527	6 x 9"	1,250	9	55	53	49
S-7564	6 x 10"	1,250	11	66	63	60
S-7565	6 x 12"	1,000	11	63	59	55
S-5453	7 x 8"	1,500	8	68	65	62
S-1264	8 x 10"	1,250	14	69	66	60
S-6528	8 x 12"	1,000	13	66	61	58
S-1265	9 x 12½"	1,000	15	75	70	67

## 2 MIL

MODEL NO.	SIZE W x L	BAGS/ROLL	LBS./ROLL	PRICE PER ROLL		
				1	3	6+
S-3032	10 x 12"	1,000	17	\$92	\$88	\$85
S-3033	10 x 16"	750	15	88	84	79
S-12370	12 x 15"	750	20	131	126	119
S-3034	12 x 18"	750	21	122	116	109
S-13590	14 x 20"	625	25	151	142	134
S-13591	15 x 18"	750	27	174	166	156
S-13592	16 x 20"	625	29	212	203	191
S-3035	18 x 24"	500	30	175	166	155
S-12371	20 x 24"	500	34	240	226	215
S-13593	24 x 24"	500	39	253	240	226
S-7566	24 x 36"	150	18	97	91	88

## 4 MIL

MODEL NO.	SIZE W x L	BAGS/ROLL	LBS./ROLL	PRICE PER ROLL		
				1	3	6+
S-13594	3 x 3"	1,750	5	\$41	\$39	\$37
S-7567	3 x 5"	1,250	6	46	43	41
S-11121	4 x 4"	1,500	7	58	55	51
S-3503	4 x 6"	1,000	8	43	41	38
S-13595	4 x 8"	750	10	45	43	41
S-3504	5 x 7"	1,000	11	59	57	53
S-3505	6 x 8"	750	11	55	53	49
S-5454	6 x 10"	500	10	42	40	36
S-13596	6 x 12"	500	11	60	58	54
S-3506	8 x 10"	500	12	45	43	41
S-7568	8 x 12"	500	14	61	59	55
S-3507	9 x 12½"	500	17	67	61	58
S-6529	10 x 12"	500	18	103	96	90
S-11122	10 x 15"	300	13	74	69	66
S-13597	10 x 16"	300	15	77	74	68
S-6530	12 x 18"	250	17	67	61	58
S-7569	18 x 24"	250	30	168	160	148
S-12372	24 x 36"	150	36	203	193	180

## POLY BAG SEALER



H-1254

## EXTRA LONG TABLETOP IMPULSE WITH CUTTER

Seal and trim larger bags and poly tubing in one step.

- Gently press to seal, then slide cutter across tubing to create a perfect sized bag.

CUTTER



### SEALER

MODEL NO.	SEAL L x W	MAX. SEAL THICKNESS	SHPG. LBS.	PRICE EACH	
				1	2+
H-1254	24 x 1/16"	8 mil	36	\$345	\$335
H-161C	6 Blades for H-1254			\$20/pkg.	

### SERVICE KIT

MODEL NO.	DESC.	KIT INCLUDES	PRICE EACH
H-1255	24" Kit	2 Heating Elements, 2 PTFE Tape Strips, 2 Covers, 1 Blade	\$47





H-161

Seal and trim poly tubing in one step.

- Press gently to seal and slide cutter across tubing to make exact bag size.
- 8-step adjustable timer.

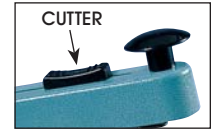

### SEALERS

MODEL NO.	SEAL L x W	MAX. SEAL THICKNESS	SHPG. LBS.	PRICE EACH	
				1	2+
H-161	8 x 1/16"	8 mil	9	\$134	\$123
H-293	12 x 1/16"		11	175	159
H-963	16 x 1/16"		13	215	195
H-1252	20 x 1/16"		15	255	230
H-161C	6 Blades for H-161, H-293, H-963 or H-1252			\$20/pkg.	

### SERVICE KITS

MODEL NO.	DESC.	KIT INCLUDES	PRICE EACH
H-495	8" Kit		\$20
H-294	12" Kit	2 Heating Elements, 2 PTFE Tape Strips, 2 Covers, 1 Blade	25
H-964	16" Kit		30
H-1253	20" Kit		35

## DELUXE TABLETOP

Engineered, developed and built in Europe.

- Fewer moving parts.
- 10-step adjustable timer.
- Wide-field magnet activates heat element.
- Less wiring and no microswitch.



H-6705

H-6706

Handles polyethylene, polypropylene, PVC – even thin laminates.

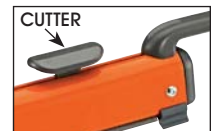

### SEALERS

MODEL NO.	SEAL L x W	MAX. SEAL THICKNESS	SHPG. LBS.	PRICE EACH	
				1	2+
H-6705	12 x 1/16"	8 mil	9	\$260	\$250
H-6706	16 x 1/16"		10	325	315
H-6707	24 x 1/16"		15	395	385
H-2065C	6 Blades for H-6705, H-6706 or H-6707			\$58/pkg.	

### SERVICE KITS

MODEL NO.	DESC.	KIT INCLUDES	PRICE EACH
H-2220	12" Kit	2 Heating Elements, 2 PTFE Tape Strips, 2 Covers, 1 Blade	\$40
H-2221	16" Kit		46
H-2222	24" Kit		50

## DELUXE FOOT-OPERATED

Ideal for high-volume poly tubing and bag sealing. Built-in cutter. Features the latest European technology.

- Variable timer control lets you seal all types of plastic films up to 24" wide and 8 mil thickness.
- Seals and trims poly tubing in one step.
- Safe, smooth operation. Less wiring and no microswitch.

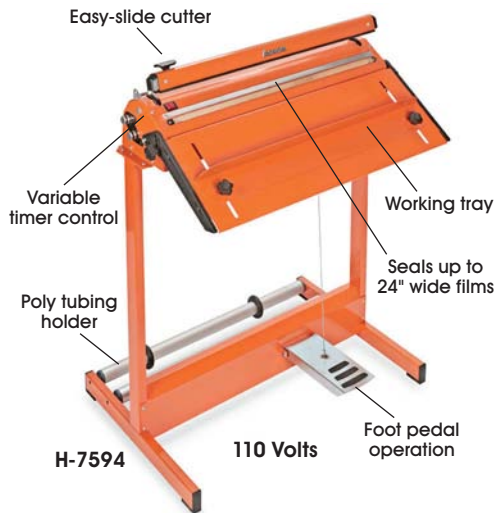

H-7594

110 Volts

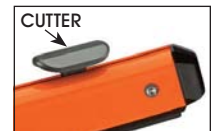

### SEALERS

MODEL NO.	SEAL L x W	MAX. SEAL THICKNESS	SHPG. LBS.	PRICE EACH
H-7593	16 x 3/16"	8 mil	62	\$1,225
H-7594	24 x 3/16"		73	1,400
H-2065C	6 Blades for H-7593 or H-7594			\$58/pkg.

### PRE-ASSEMBLED SERVICE KITS

MODEL NO.	DESC.	KIT INCLUDES	PRICE EACH
H-7596	16" Kit	Heating Element, PTFE Tape and Cover, Sealing Bar	\$70
H-7597	24" Kit		85

■ SHIPS ASSEMBLED VIA MOTOR FREIGHT



## TEFLON® ROLLS

**TAPE** – Adhesive tape is used under the heating wire. For use with all sealers.

**FABRIC COVER** – Place over the heating wire. No adhesive. Use with tabletop sealers up to 20".

MODEL NO.	DESCRIPTION		MIL	PRICE EACH		
	STYLE	W x L		1	2	3+
S-5331	Tape	3/8" x 36 yds.	3	\$40	\$37	\$35
S-7196		1" x 18 yds.		35	32	30
S-6783	Fabric	1½" x 36 yds.		52	48	45

## TABLETOP

Place poly bag between seal bars, press down gently and release. Also seals polypropylene and foam.

- No warmup time needed.
- Adjustable timer creates perfect seals for varying bag thicknesses.

### SEALERS

MODEL NO.	SEAL L x W	MAX. SEAL THICKNESS	SHPG. LBS.	PRICE EACH	
				1	2+
H-458	4 x 1/16"	8 mil	5	\$63	\$58
H-163	8 x 1/16"		6	88	78
H-190	12 x 1/16"		10	123	112
H-306	16 x 1/16"		11	159	145
H-1029	20 x 1/16"		12	210	196

### SERVICE KITS

MODEL NO.	DESC.	KIT INCLUDES	PRICE EACH
H-471	4" Kit	2 Heating Elements, 2 PTFE Tape Strips, 2 PTFE Covers	\$9
H-164	8" Kit		18
H-191	12" Kit		22
H-307	16" Kit		27
H-1042	20" Kit		31



H-163

## BEEP SEALERS

Easy-to-use impulse sealer. Less pressure to activate.

- Automatically beeps when seal is done.
- Heating element is easy to change.

### SEALERS

MODEL NO.	SEAL L x W	MAX. SEAL THICKNESS	SHPG. LBS.	PRICE EACH	
				1	2+
H-597	8 x 1/16"	8 mil	6	\$110	\$100
H-599	12 x 1/16"		9	145	135

### SERVICE KITS

MODEL NO.	DESC.	KIT INCLUDES	PRICE EACH
H-598	8" Kit	2 Heating Elements, 2 PTFE Tapes & Covers	\$18
H-600	12" Kit		22



H-597

## EXTRA-LONG TABLETOP

Seal larger bags with this extra-long tabletop sealer.

- Durable steel construction. No warmup time needed.
- Convenient carry handle to easily move production area.

### SEALERS

MODEL NO.	SEAL L x W	MAX. SEAL THICKNESS	SHPG. LBS.	PRICE EACH	
				1	2+
H-1246	24 x 1/16"	8 mil	24	\$290	\$280
H-1247	32 x 1/16"		26	375	355

### SERVICE KITS

MODEL NO.	DESC.	KIT INCLUDES	PRICE EACH
H-1248	24" Kit	2 Heating Elements, 2 PTFE Tapes & Covers	\$42
H-1249	32" Kit		52

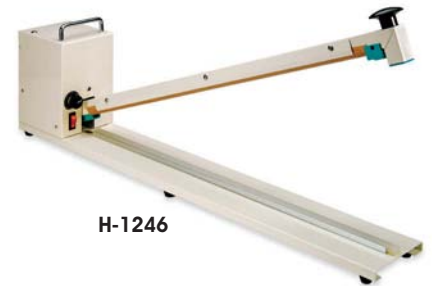

H-1246

## FOOT-OPERATED

Ideal for high-volume poly bag sealing.

- Variable timer control lets you seal all types of plastic films up to 24" wide and 8 mil thickness.
- Extra-long foot sealer for sealing bags up to 30" wide.
- For use with polyethylene and metallic bags.

### SEALERS

MODEL NO.	SEAL L x W	MAX. SEAL THICKNESS	SHPG. LBS.	PRICE EACH
H-87	12 x 1/16"	8 mil	48	\$305
H-89	18 x 1/16"		54	345
H-86	24 x 1/16"		56	499

### SERVICE KITS

MODEL NO.	DESC.	KIT INCLUDES	PRICE EACH
H-173	12" Kit	2 Heating Elements, 1 Large PTFE Sheet, 2 Strips PTFE Tape	\$27
H-174	18" Kit		34
H-204	24" Kit		48

### EXTRA-LONG SEALER

H-1250	30 x 1/16"	8 mil	53	\$619
--------	------------	-------	----	-------

### EXTRA-LONG SERVICE KIT

H-1251	30" Kit	2 Heating Elements, 2 PTFE Tapes & Covers	\$55
--------	---------	--	------

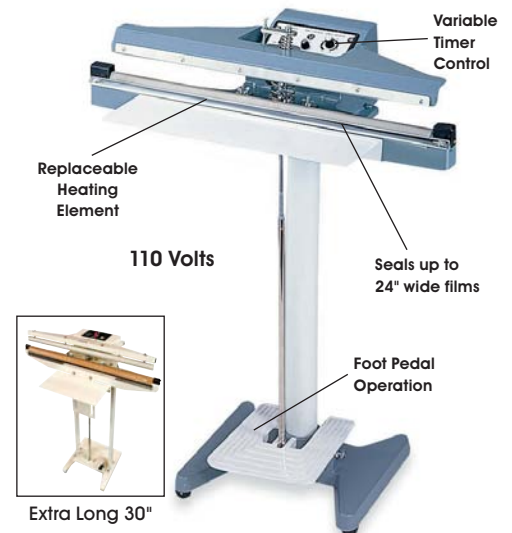

Extra Long 30"

# BLACK UV CABLE TIES



Tamperproof ties secure bags, cords and cables permanently.

- Approved for outdoor use. • UL Listed 6.6 nylon.
- Locks tightly – Won't stretch or slide.
- Temperature range -40° to 180°F.

## BLACK UV STABILIZED

MODEL NO.	LENGTH	WIDTH	TENSILE STRENGTH	QTY./PACK	PRICE PER PACK					
					1	5	10	20+		
S-5826	4"	.10"	18 lbs.	1,000	\$22	\$21	\$20	\$19		
S-5827	5½"			1,000	24	23	22	21		
S-14034	6"			1,000	26	25	24	23		
S-14035	7"			1,000	30	28	26	25		
S-12394	8"			1,000	32	31	30	28		
S-5828	5½"	.14"	40 lbs.	1,000	30	28	26	25		
S-5829	6"			1,000	32	31	30	28		
S-5830	7"			1,000	36	35	34	33		
S-5831	8"			1,000	\$36 per pack any quantity					
S-14036	9"			500	28	26	25	24		
S-12395	10"			500	30	28	26	25		
S-12396	11"			500	33	32	31	30		
S-22719	12"			500	34	33	32	31		
S-14037	13"			500	36	35	34	33		
S-12398	15"			500	42	41	40	39		
S-14932	7"	.19"	50 lbs.	1,000	52	50	46	44		
S-11131	8"			1,000	59	57	55	53		
S-14038	10"			1,000	64	62	60	57		
S-5832	11"			1,000	73	70	66	63		
S-12399	12"			1,000	89	85	80	76		
S-5833	14"			1,000	106	100	95	90		
S-5834	16"			500	64	62	60	58		
S-12400	18"			500	65	63	61	59		
S-12401	21"			500	77	74	71	68		
S-14933	8"			.25"	80 lbs.	100	18	17	15	14
S-14934	14"					100	21	20	19	18
S-14935	24"	100	36			35	34	33		
S-14936	8"	.30"	120 lbs.	100	20	19	18	17		
S-14039	11"			100	21	20	19	18		
S-5835	14"			100	22	21	20	19		
S-22720	18"			100	31	29	26	24		
S-14040	21"			100	45	43	41	39		
S-12397	24"			100	54	52	50	46		

# JUMBO CABLE TIES



HUGE SELECTION  
IN STOCK

Super-tough nylon ties secure heavy duct, wires and cables.

- 36" cable bundles up to 11" diameter.
- 48" cable bundles up to 15" diameter.
- 60" cable bundles up to 20" diameter.

## JUMBO NATURAL

## EXTRA HEAVY DUTY

MODEL NO.	LENGTH	WIDTH	TENSILE STRENGTH	QTY./PACK	PRICE PER PACK			
					1	5	10	20+
S-14024	15"	.35"	175 lbs.	100	\$39	\$36	\$34	\$33
S-11144	18"			100	41	39	36	35
S-5072	21"			100	63	59	55	52
S-14025	24"			100	70	66	61	56
S-5825	25"			100	74	68	62	57
S-12402	30"			100	80	75	70	63
S-14026	32"			100	86	81	76	69
S-9897	36"			100	88	82	76	70
S-12403	40"			100	95	89	82	76
S-7310	48"			50	74	69	62	58
S-11147	60"	50	95	90	81	77		
S-11145	14"	.50"	250 lbs.	100	47	43	40	37
S-11146	17"			100	55	51	47	43
S-5694	18"			100	59	56	52	46
S-13445	21"			100	66	62	57	53
S-5695	24"			100	73	68	62	58
S-14027	28"			100	86	79	74	69
S-12404	30"			100	89	83	77	71
S-5696	36"			100	97	91	82	78
S-12405	41"			100	106	99	91	87

## JUMBO BLACK UV STABILIZED

## EXTRA HEAVY DUTY

MODEL NO.	LENGTH	WIDTH	TENSILE STRENGTH	QTY./PACK	PRICE PER PACK			
					1	5	10	20+
S-7743	18"	.35"	175 lbs.	100	\$43	\$41	\$39	\$37
S-12406	21"			100	68	62	57	54
S-11132	24"			100	76	71	64	59
S-13429	30"	.50"	250 lbs.	100	82	77	72	64
S-7744	36"			100	91	85	79	73
S-11133	40"			100	98	93	86	79
S-12409	48"			50	76	71	64	60
S-12407	18"	.50"	250 lbs.	100	62	58	54	50
S-12408	36"			100	99	93	85	80



# NYLON NATURAL CABLE TIES

Tamperproof ties secure bags, cords and cables permanently.

- Locks tightly – Won't stretch or slide.
- UL Listed 6.6 nylon.



MODEL NO.	LENGTH	WIDTH	TENSILE STRENGTH	QTY./PACK	PRICE PER PACK			
					1	5	10	20+
S-3569	3"	.09"	18 lbs.	1,000	\$19	\$18	\$17	\$15
S-1411	4"	.10"	18 lbs.	1,000	21	20	19	18
S-5070	5½"			1,000	23	22	21	20
S-11134	6"			1,000	25	24	23	22
S-11135	7"			1,000	28	26	25	24
S-5071	8"			1,000	31	30	28	26
S-23454	10"	.14"	40 lbs.	1,000	34	33	32	31
S-23455	15"			1,000	44	42	40	37
S-5272	4"			1,000	24	23	22	21
S-11136	5"			1,000	25	24	23	22
S-1020	5½"			1,000	26	25	24	23
S-5273	6"	.19"	50 lbs.	1,000	30	28	26	25
S-3570	7"			1,000	34	33	32	31
S-1021	8"			1,000	\$34 per pack any quantity			
S-5274	9"			500	25	24	23	22
S-3807	10"			500	26	25	24	23
S-5275	11"	.25"	80 lbs.	500	31	30	28	26
S-22710	12"			500	32	31	30	28
S-5283	13"			500	34	33	32	31
S-11137	14"			500	39	37	36	35
S-5823	15"			500	40	39	37	36
S-11138	5½"	.30"	120 lbs.	1,000	44	42	40	37
S-12377	6"			1,000	45	43	41	39
S-11139	7"			1,000	47	45	43	41
S-3808	8"			1,000	55	53	51	47
S-14011	9"			1,000	59	57	55	53
S-11140	10"	.19"	50 lbs.	1,000	61	59	57	55
S-1022	11"			1,000	70	66	63	60
S-7740	12"			1,000	86	81	77	73
S-14012	13"			1,000	93	89	83	78
S-1023	14"			1,000	103	97	92	87
S-3809	16"	.25"	80 lbs.	500	61	59	57	55
S-11141	17"			500	62	60	58	56
S-5824	18"			500	68	64	61	58
S-14013	19"			500	70	66	63	60
S-9896	21"			500	74	71	68	64
S-22711	24"	.30"	120 lbs.	100	21	20	19	18
S-11143	36"			100	42	40	37	35

MODEL NO.	LENGTH	WIDTH	TENSILE STRENGTH	QTY./PACK	PRICE PER PACK			
					1	5	10	20+
S-14014	6"	.25"	80 lbs.	100	\$14	\$13	\$12	\$11
S-13446	8"			100	17	15	14	13
S-14015	10"			100	18	17	15	14
S-12378	12"			100	20	19	18	17
S-12379	14"			100	21	20	19	18
S-16557	16"	.30"	120 lbs.	100	23	22	21	20
S-14016	18"			100	25	24	23	22
S-13447	20"			100	33	32	31	30
S-16558	22"			100	34	33	32	31
S-6619	24"			100	35	34	33	32
S-16559	6"	.30"	120 lbs.	100	17	15	14	13
S-7309	8"			100	18	17	15	14
S-16560	10"			100	19	18	17	15
S-7741	11"			100	20	19	18	17
S-16561	13"			100	21	20	19	18
S-2676	14"			100	22	21	20	19
S-13448	16"			100	28	26	25	24
S-12380	18"			100	33	32	31	30
S-13449	21"			100	44	42	40	37
S-14017	22"			100	51	47	45	43
S-7742	24"			100	53	51	47	45
S-14018	26"			100	57	55	53	51
S-11142	28"	100	66	63	60	57		

(Not actual size)



LARGER QUANTITIES OF CABLE TIES, CALL FOR QUOTE

# STAINLESS STEEL CABLE TIES

MODEL NO.	LENGTH	WIDTH	TENSILE STRENGTH	QTY./BOX	PRICE PER BOX			
					1	5	10	20+
S-13604	8"	.18"	150 lbs.	100	\$65	\$62	\$58	\$55
S-13605	14"				78	74	70	66
S-13606	20"				90	86	81	76
S-13607	27"				107	102	97	92

For outdoor use. Withstands harshest conditions.

- Secure cables, wires and pipes.
- Self-locking head guarantees security.



## IDENTIFICATION TIES



- EXTRA LARGE 2 x 3"**  
Label unassembled parts and heavy machinery.
- Self-locking ties are tamper evident.
  - Moisture resistant.
  - Color code inventory.

SPECIFY COLOR: ■ Red ■ Green ■ Yellow ■ Blue

MODEL NO.	LENGTH	WIDTH	TENSILE (LBS.)	WRITING AREA	PRICE PER PACK OF 100		
					1	5	10+
S-16555	6"				\$59	\$56	\$53
S-16556	9"	.25"	120	2 x 3"	67	64	61

## IDENTIFICATION TIES

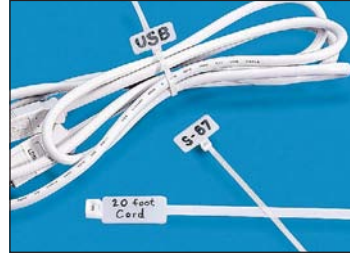

- Recommended for writing part numbers, wiring data.
- Self-locking ties are tamper evident.
  - S-7747 flexible enough to tie as small as 1/16" diameter.

MODEL NO.	LENGTH	WIDTH	TENSILE (LBS.)	WRITING AREA	PRICE PER PACK OF 1,000			
					1	5	10	20+
S-7747	4"	.10"	18	3/4 x 3/8"	\$62	\$59	\$56	\$53
S-2934	7"	.295"	50	1 1/2 x 1/2"	105	100	95	89

## LADDER TIES



- Bundle merchandise together for maximum efficiency.
- Flexible and strong.
  - Bundles as small as 1/16" diameter.
  - Lightweight, low cost.

MODEL NO.	LENGTH	COLOR	TENSILE (LBS.)	PRICE PER PACK OF 1,000			
				1	5	10	20+
S-8122	7"	Natural	40	\$36	\$34	\$32	\$30
S-8123		Black		37	35	33	31
S-8124	11"	Natural		52	50	47	45
S-8125		Black		53	51	48	46

## SECURITY LOOPS



- Attach tags to hardware, glasses and luggage.
- No gun needed. Ends snap together easily by hand.
  - Tamperproof; won't pull apart.

MODEL NO.	LENGTH	COLOR	TENSILE (LBS.)	PRICE PER BOX OF 5,000			
				1	5	10	20+
S-11164	3"	Natural	7.5	\$32	\$30	\$27	\$24
S-11165	5"			34	32	29	26
S-11166	9"			38	36	33	29

## BEADED SECURITY TIES

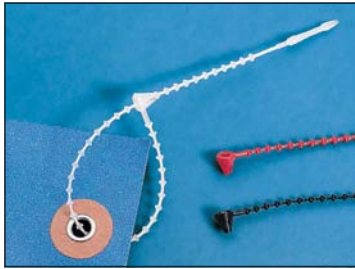

- Tag parts and merchandise.
- Adjustable, tamper-evident ties.
  - Color code inventory.
  - Easy to use. No gun needed.

MODEL NO.	LENGTH	DESCRIPTION	TENSILE (LBS.)	QTY./BOX	PRICE PER BOX		
					1	5	10+
S-7746	5"	Natural	15	5,000	\$55	\$50	\$45
S-7751		Red or Black			65	58	51
S-8092	8"	Natural	15	2,000	67	62	57
S-14053		Red or Black			76	72	66

## CABLE TIE GUNS



H-241 ECONOMY



Deluxe comfort grip handle

Dual tension settings with easy-to-read display

H-6534 DELUXE

H-241 Economy – Cuts ties up to 50 lbs. tensile. Easy to use.

H-6534 Deluxe – Tightens and cuts ties up to 250 lbs. tensile with one squeeze. Highly recommended for repetitive use.

MODEL NO.	DESCRIPTION	MAXIMUM TENSILE	PRICE EACH	
			1	3+
H-241	Economy	50 lbs.	\$16	\$15
H-6534	Deluxe	250 lbs.	360	350

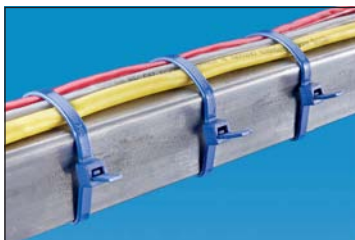

## METAL DETECTABLE CABLE TIES

Guard against contamination in food and pharmaceutical processing.

- Nylon ties with metal content trigger detectors.
- UL Listed 6.6 nylon.

MODEL NO.	LENGTH	WIDTH	TENSILE (LBS.)	QTY./PACK	PRICE PER PACK		
					1	3	5+
S-16562	6"	.14"	30	100	\$27	\$25	\$23
S-16563	8"	.18"	50		36	34	32
S-16564	15"	.18"	50		70	65	62

# COLORED CABLE TIES



REGULAR COLORS

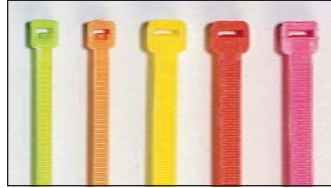

FLUORESCENT COLORS

SPECIFY COLOR: Regular: Green, Yellow, Red, Blue, Purple or Gray  
Fluorescent: Green, Orange, Yellow, Red or Pink

MODEL NO.	LENGTH	WIDTH	TENSILE STRENGTH	QTY./PACK	PRICE PER PACK				
					1	5	10	20+	
S-2151	4"	.10"	18 lbs.	1,000	\$21	\$20	\$19	\$18	
S-2152	5½"	.14"	40 lbs.	1,000	29	28	27	26	
S-2153	8"				38	37	36	35	
S-2154	11"	.19"	50 lbs.	1,000	71	68	65	61	
S-2155	14"				104	99	93	88	
S-12356	18"				500	72	70	68	66

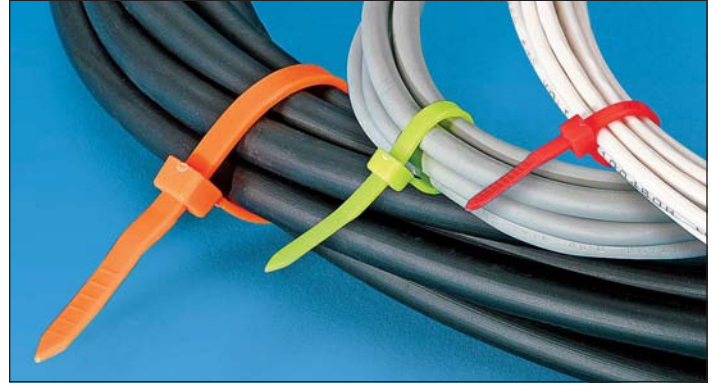

Create a color coding system.

- Locks tightly – Won't stretch or slide.
- Tamperproof for permanent use.
- UL Listed 6.6 nylon.

LARGER QUANTITIES OF CABLE TIES, CALL FOR QUOTE

# CABLE TIE KITS

MODEL NO.	LENGTH	COLOR	QTY./KIT	LBS./KIT	PRICE PER KIT		
					1	2	10+
S-6706	Assorted	Natural*	1,000	3	\$43	\$42	\$41
S-6707		Assorted▲	1,000	3	45	44	43

Our most popular sizes and colors of self-locking nylon cable ties. All the sizes you need.

\* Includes: 400 5½" ties in 40-lb. tensile strength; 400 8" ties in 40-lb. tensile strength; and 200 11" ties in 50-lb. tensile strength.

▲ Includes: 80 each of Black, Blue, Green, Red and Yellow of 5½" and 8" ties in 40-lb. tensile strength; 40 each of the same colors of 11" ties in 50-lb. tensile strength.



# RELEASABLE CABLE TIES

SPECIFY COLOR: Black or Natural

MODEL NO.	LENGTH	WIDTH	TENSILE STRENGTH	QTY./PACK	PRICE PER PACK			
					1	5	10	20+
S-1258	5½"	.295"	50 lbs.	1,000	\$66	\$63	\$60	\$57
S-1259	8"				76	72	69	67
S-5366	10"				97	91	89	85
S-11158*	12"	.30"	120 lbs.	100	22	21	20	19
S-14019*	14"				24	23	22	21
S-11159*	16"				26	25	24	23
S-14020*	21"				37	35	34	32
S-11160*	26"	.35"	175 lbs.	100	42	41	40	37
S-14021*	36"				75	72	69	64
S-14022*	18"	.50"	250 lbs.	100	55	53	51	46
S-14023*	24"				71	69	66	63

\*Slightly different than pictured



BLACK

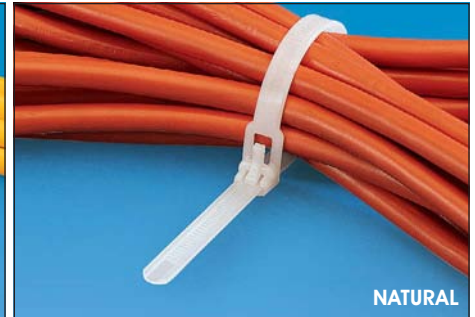

NATURAL

Ideal for frequently used cables, wires, etc.

- Easy-to-use nylon ties. Just press tab, release and re-use.
- No need to cut ties to add or remove bundled cables.

# CABLE TIE MOUNTS

Keep cables bundled and organized.

- Adhesive backing sticks to walls and floors.

SPECIFY COLOR: Black or Natural

MODEL NO.	SIZE L x W	FITS CABLE TIES	QTY./PACK	PRICE PER PACK			
				1	5	10	20+
S-12410	3/4 x 3/4"	Up to .14"	100	\$12	\$11	\$10	\$9
S-12411	1 x 1"	Up to .19"		17	16	15	14
S-14938	1½ x 1½"	Up to .30"		27	25	23	20



BLACK



NATURAL



# COLORED SHOPPING BAGS



## TINTED COLOR

Quickly package multiple purchases in these heavy-duty bags.

- Square-bottom bags stand alone for convenient packaging.
- Strong twisted paper handles make purchases easy to carry.
- Matte finish 60-70 lb. paper.

Kraft – Rich matte colors give purchases a natural look.

## DELUXE COLOR

Deluxe – Bold colors with bright white interior for a classier presentation.

SPECIFY COLOR:

MODEL NO.	BAG NAME	SIZE W x D x H	QTY./CTN.	PRICE PER CARTON			LBS./CTN.
				1	3	5+	
S-12554	Rose	5½ x 3¼ x 8¾"	250	\$111	\$106	\$104	13
S-13143*	Wine	5½ x 3¼ x 13"		116	110	108	16
S-8591	Cub	8 x 4½ x 10¼"		<b>\$91 per carton any quantity</b>			
S-11636	Debbie	10 x 5 x 13"		125	120	117	27
S-8592	Vogue	16 x 6 x 12"		142	137	134	38
S-8593	Queen	16 x 6 x 19¼"	200	142	137	134	41
S-13144	Jumbo	18 x 7 x 18¾"		177	170	167	46

\*Not available in Oatmeal

SPECIFY COLOR:

MODEL NO.	BAG NAME	SIZE W x D x H	QTY./CTN.	PRICE PER CARTON			LBS./CTN.
				1	3	5+	
S-19958	Cub	8 x 4½ x 10¼"	250	<b>\$112 per carton any quantity</b>			20
S-19959	Debbie	10 x 5 x 13"		\$140	\$135	\$130	27
S-19960	Vogue	16 x 6 x 12"		165	160	155	38

# RECYCLED PAPER SHOPPING BAGS

Earth-friendly bags for environmentally conscious shoppers.

- Meet most U.S. recycled paper bag requirements.
- 100% recycled with post-consumer content.
- Matte finish 60 lb. paper. Strong twisted paper handles.



MODEL NO.	BAG NAME	SIZE W x D x H	QTY./CTN.	PRICE PER CARTON			LBS./CTN.
				1	3	5+	
S-19973	Rose	5¼ x 3¼ x 8¼"	250	<b>\$70 per carton any quantity</b>			13
S-20672	Wine	5½ x 3¼ x 12½"		\$82	\$80	\$76	16
S-21195	Double Wine	6½ x 3½ x 12¾"		86	83	79	18
S-19974	Cub	8 x 4¼ x 10¼"	250	<b>\$68 per carton any quantity</b>			20
S-19975	Debbie	10 x 5 x 12¾"		<b>\$81 per carton any quantity</b>			25
S-20673	Take Out	14 x 10 x 15½"	200	113	111	106	42
S-19976	Vogue	16 x 6 x 12"	250	<b>\$96 per carton any quantity</b>			39
S-19977	Queen	16 x 6 x 19¼"	200	102	99	95	39
S-21196	Jumbo	18 x 7 x 18¾"		109	107	102	46



# PAPER SHOPPING BAGS



## KRAFT

MODEL NO.	BAG NAME	SIZE W x D x H	QTY./CTN.	PRICE PER CARTON			LBS./CTN.
				1	3	5+	
S-7636	Rose	5½ x 3¼ x 8¾"	250	<b>\$70 per carton any quantity</b>			13
S-8590	Wine	5½ x 3¼ x 13"		\$82	\$80	\$76	16
S-13049	Double Wine	6½ x 3½ x 12¾"		86	83	79	18
S-7098	Cub	8 x 4½ x 10¼"		<b>\$68 per carton any quantity</b>			20
S-7260	Debbie	10 x 5 x 13"		<b>\$81 per carton any quantity</b>			27
S-9660	Traveler	13 x 6 x 15¾"		100	97	93	36
S-13050	Star	13 x 7 x 13"		104	101	97	34
S-8589	Mart	13 x 7 x 17"		117	114	110	41
S-9661	Take Out	14 x 10 x 15½"	200	113	111	106	42
S-7099	Vogue	16 x 6 x 12"	250	<b>\$96 per carton any quantity</b>			37
S-7100	Queen	16 x 6 x 19¼"	200	102	99	95	41
S-7261	Jumbo	18 x 7 x 18¾"		109	107	102	48

Quickly package multiple purchases in these heavy-duty bags.

- Square-bottom bags stand alone for convenient packaging.
- Strong twisted paper handles make purchases easy to carry.
- Matte finish 60-70 lb. paper.
- Durable bags can be used again and again.

## WHITE

S-8518	Rose	5½ x 3¼ x 8¾"	250	<b>\$75 per carton any quantity</b>			13
S-9664	Wine	5½ x 3¼ x 13"		\$88	\$85	\$81	16
S-13051	Double Wine	6½ x 3½ x 12¾"		91	88	84	18
S-7262	Cub	8 x 4½ x 10¼"		<b>\$81 per carton any quantity</b>			20
S-8519	Debbie	10 x 5 x 13"		<b>\$89 per carton any quantity</b>			27
S-9666	Traveler	13 x 6 x 15¾"		111	108	104	36
S-13052	Star	13 x 7 x 13"		114	110	106	34
S-9667	Mart	13 x 7 x 17"		127	123	120	41
S-9668	Take Out	14 x 10 x 15½"	200	121	118	115	42
S-7101	Vogue	16 x 6 x 12"	250	<b>\$110 per carton any quantity</b>			37
S-8520	Queen	16 x 6 x 19¼"	200	109	106	103	41
S-8521	Jumbo	18 x 7 x 18¾"		120	116	113	48



## CUSTOM PRINTED SHOPPING BAGS

See our website at [uline.com/custom](http://uline.com/custom) or call Customer Service for complete custom information.

# MATTE LAMINATE SHOPPING BAGS



Handsome, upscale look especially popular in men's departments.

- Soft, flexible rope handles.
- 120 gsm paper with reinforced chipboard bottom and top.



SPECIFY COLOR

MODEL NO.	BAG NAME	SIZE W x D x H	QTY./ CTN.	PRICE PER CARTON			LBS./ CTN.
				1	3	5+	
S-23479	Wine	5 x 3½ x 13¼"	100	\$93	\$88	\$83	9
S-15481	Mini	6½ x 3½ x 6½"		67	64	61	7
S-12519	Cub	8 x 4 x 10"		<b>\$73 per carton any quantity</b>			11
S-13129	Shorty	9 x 3½ x 7"		79	76	73	10
S-14151	Debbie	10 x 5 x 13"		96	93	90	17
S-12520	Boutique	13 x 5 x 10"		96	93	90	17
S-13130	Vogue	16 x 6 x 12"		111	108	105	24
S-16669	Queen	16 x 6 x 19¼"		129	125	121	30

## KRAFT EUROTOTES

Simple, elegant style for boutiques and high-end retailers.

- Soft cotton rope handles. Reinforced top and chipboard bottom.
- Heavy 170 gsm kraft paper with embossed stripe pattern.



MODEL NO.	BAG NAME	SIZE W x D x H	QTY./ CTN.	PRICE PER CARTON			LBS./ CTN.
				1	3	5+	
S-19969	Cub	8 x 4 x 10"	100	\$85	\$80	\$75	12
S-19970	Debbie	10 x 5 x 13"		105	100	95	18
S-19971	Boutique	13 x 5 x 10"		105	100	95	18
S-19972	Vogue	16 x 6 x 12"		120	115	110	25

## PRINTED KRAFT PAPER SHOPPING BAGS

Distinctive patterns add dramatic flair to these natural kraft shoppers.

- Strong twisted paper handles make purchases easy to carry.
- Reusable and recyclable. Matte finish 60-65 lb. paper.



Holiday prints, see [uline.com](http://uline.com)

SPECIFY STYLE: Paw Print Geo Chevron



MODEL NO.	BAG NAME	SIZE W x D x H	QTY./ CTN.	PRICE PER CARTON			LBS./ CTN.
				1	3	5+	
S-21245	Cub	8 x 4½ x 10¼"	250	\$90	\$87	\$84	20
S-21246	Vogue	16 x 6 x 12"		133	130	126	36



# HIGH GLOSS SHOPPING BAGS



## HIGH GLOSS

SPECIFY COLOR

MODEL NO.	BAG NAME	SIZE W x D x H	QTY./ CTN.	PRICE PER CARTON			LBS./ CTN.
				1	3	5+	
S-12488	Wine	5 x 3½ x 13¼"	100	\$78	\$76	\$72	10
S-10572	Rose	5¼ x 3¼ x 8¾"		60	57	53	7
S-13127	Mini	6½ x 3½ x 6½"		60	57	53	7
S-8586	Cub	8 x 4 x 10"		<b>\$66 per carton any quantity</b>			11
S-11621	Debbie	10 x 5 x 13"		84	81	77	17
S-15480	Boutique	13 x 5 x 10"		84	81	77	17
S-8587	Vogue	16 x 6 x 12"		100	97	94	24
S-8588	Queen	16 x 6 x 19¼"		113	109	106	30

Showcase your merchandise in these distinctive, high gloss laminated bags.

- Chipboard reinforced bottom.

### HIGH GLOSS



### METALLIC



## HIGH GLOSS METALLICS

SPECIFY COLOR

MODEL NO.	BAG NAME	SIZE W x D x H	QTY./ CTN.	PRICE PER CARTON			LBS./ CTN.
				1	3	5+	
S-12489	Rose	5¼ x 3¼ x 8¾"	100	\$113	\$109	\$106	8
S-9862	Cub	8 x 4 x 10"		139	134	129	12
S-13128	Debbie	10 x 5 x 13"		147	141	136	17
S-11622	Vogue	16 x 6 x 12"		179	172	166	25

# RIBBON HANDLE EUROTOTES



Premium bags for gifts and luxury items at salons, spas and gallery shops.

- Comfortable, soft cotton twill handles.
- Heavy 200 gsm uncoated paper with reinforced chipboard bottom.

\* Only available in Kraft, White or Black

MODEL NO.	BAG NAME	SIZE W x D x H	QTY./ CTN.	PRICE PER CARTON			LBS./ CTN.
				1	3	5+	
S-25096*	Mini	5 x 4 x 6"	100	\$106	\$103	\$100	9
S-21150	Cub	8 x 4 x 10"		128	125	122	15
S-21151	Debbie	10 x 5 x 13"		190	185	180	18
S-21152	Vogue	16 x 6 x 12"		206	201	196	31



# FLAT MERCHANDISE BAGS

KRAFT

FDA COMPLIANT

MODEL NO.	SIZE W x L	BASIS WEIGHT	QTY./ CTN.	PRICE PER CARTON			LBS./ CTN.
				1	5	10+	
S-12491	5 x 7½" (5)	30 lb.	1,000	\$29	\$27	\$25	7
S-6915	6¼ x 9¼" (6)			30	28	26	11
S-6916	7½ x 10½" (7)			37	35	33	14
S-6917	8½ x 11" (8)			41	39	37	16
S-6918	10 x 13" (10)			53	51	48	21
S-6919	12 x 15" (12)			64	60	55	29
S-8537	14¾ x 18" (15)	35 lb.	500	52	50	47	21
S-11623	17 x 21" (17)			63	58	55	32
S-8538	12 x 3 x 18" (16)			52	50	47	25
S-11624	14 x 3 x 21" (17)			63	58	55	35
S-8539	17 x 4 x 24" (21)			99	93	85	46

WHITE

FDA COMPLIANT

MODEL NO.	SIZE W x L	BASIS WEIGHT	QTY./ CTN.	PRICE PER CARTON			LBS./ CTN.
				1	5	10+	
S-21247	5 x 7½" (5)	30 lb.	1,000	\$36	\$34	\$32	7
S-8540	6¼ x 9¼" (6)			37	35	33	11
S-8541	8½ x 11" (8)			57	55	52	16
S-12492	10 x 13" (10)			75	72	69	21
S-8498	12 x 15" (12)			89	85	81	29
S-14250	14¾ x 18" (15)			68	66	63	21



Package greeting cards, magazines and other lightweight items.

- Easy-to-open serrated end.

# HARDWARE BAGS

GUSSETED 52-57 LB.

KRAFT

MODEL NO.	SIZE W x D x H	BASIS WEIGHT	QTY./ BNDL.	PRICE PER BUNDLE (MIN. 2)			LBS./ BNDL.
				2	5	10+	
S-6910	4½ x 2½ x 7½" (2)	52 lb.	250	\$14	\$13	\$12	4
S-9750	4¾ x 2½ x 8½" (3)			16	15	14	5
S-6911	5 x 3¼ x 9¼" (4)			17	16	15	6
S-8530	5¼ x 3½ x 10½" (5)			19	18	17	7
S-6912	6 x 3½ x 11" (6)			21	20	19	8
S-7630	6½ x 4½ x 12½" (8)			57 lb.	250	24	23
S-6913	6½ x 4½ x 13½" (10)	27	26			25	12
S-6914	7½ x 4½ x 13¾" (12)	31	30			28	14
S-8531	7¾ x 4¾ x 16" (16)	35	34			33	17
S-8532	8¼ x 5½ x 16½" (20)	39	38			37	19
S-7631	8½ x 5¼ x 18" (25)	42	41			40	20



Heavy-duty kraft paper bags hold metal parts without puncturing or tearing.

- Can also be used to wrap industrial items for protection from dust and dirt.

# COLORED LUNCH BAGS

SPECIFY COLOR: Red, Black or Blue



Vibrant colored packaging, economical price.

- Easy-to-open bags. Stand-up square bottoms.

MODEL NO.	SIZE W x D x H	BASIS WEIGHT	QTY./ CTN.	PRICE PER CARTON			LBS./ CTN.
				1	5	10+	
S-11566	4 x 2 x 8" (2)	32 lb.	500	\$59	\$57	\$55	7
S-11567	6 x 4 x 11" (6)			71	69	67	13
S-11568	6 x 4 x 13" (8)			78	76	74	15

# BOTTLE CARRIERS

WINE

BEER



Ideal tote for quick and easy transportation.

- Flat packed for easy storage.
- Strong corrugated construction.

Safely carry standard 12-oz. glass beer and soda bottles.

- Flat packed for easy storage.
- Sturdy chipboard construction.



200 LB. TEST

SPECIFY COLOR: White or Kraft

MODEL NO.	SIZE L x W x H	HOLDS # BTL.	QTY./ BUNDLE	PRICE PER BUNDLE	
				1	5+
S-17052	7 x 7 x 12"	4	25	\$62	\$58
S-14251	10 x 7 x 12"	6		66	62

.018 CALIPER

SPECIFY COLOR: White or Kraft

MODEL NO.	SIZE L x W x H	HOLDS # BTL.	QTY./ CARTON	PRICE PER CARTON	
				1	5+
S-19906	5 x 5 x 7¼"	4	200	\$139	\$131
S-19907	7½ x 5 x 7½"	6		160	117

# GROCERY BAGS

KRAFT

S-9826 and S-9827: pinch bottom bags. S-11540: satchel bottom bag.

MODEL NO.	SIZE W x D x H	BASIS WEIGHT	QTY./ BNDL.	PRICE PER BUNDLE (MIN. 2)			LBS./ BNDL.
				2	5	10+	
S-9826	3¼ x 2¼ x 11½" (Pint)	35 lb.	500	\$28	\$27	\$26	7
S-9827	4½ x 2½ x 16" (Quart)			40	39	38	10
S-13236	3 x 1⅞ x 5⅞" (1/2)	30 lb.	500	18	17	16	3
S-11538	3½ x 2⅝ x 6⅞" (1)			20	19	18	4
S-13237	4⅞ x 2⅝ x 7⅞" (2)			20	19	18	5
S-13238	4¾ x 2⅝ x 8⅞" (3)			21	20	19	6
S-7082	5 x 3¼ x 9¾" (4)			22	21	20	7
S-13239	5¼ x 3⅞ x 10⅝" (5)			27	26	25	10
S-7083	6 x 3⅝ x 11" (6)	35 lb.	500	29	28	27	11
S-7084	6⅞ x 4 x 12⅞" (8)			36	35	34	13
S-7085	6⅞ x 4⅞ x 13⅞" (10)			39	38	37	15
S-7086	7⅞ x 4½ x 13¾" (12)			46	45	44	18
S-8533	7¾ x 4¾ x 16" (16)	40 lb.	500	53	51	49	23
S-13240	8¼ x 5⅞ x 16⅞" (20)			61	59	57	26
S-13241	8¼ x 5¼ x 18" (25)			64	62	60	29
S-13242	8¼ x 5⅞ x 13⅞" (20 SH)			62	60	58	25
S-13243	8¼ x 6⅞ x 15⅞" (25 SH)			66	64	62	27
S-9621	12 x 7 x 17" (1/6 BL)			57 lb.		\$91 per bundle	
S-9751	12 x 7 x 17" (1/6 BL)	66 lb.	500	115	110	105	59
S-11539	12 x 7 x 21¾" (1/4 BL)		250	115	110	105	39
S-11540	17 x 6 x 29" (1/4 BL)	52 lb.	250	110	105	100	35



## GUSSETED 30-70 LB.

Use these paper bags to pack sandwiches, food orders or retail purchases.

- FDA compliant.

## FLAT HANDLE

Provide added convenience for your buyers.

- Comfortable, reinforced handles.
- Folds flat for storage.



WHITE

S-14148	3½ x 2⅝ x 6⅞" (1)	30 lb.	500	\$22	\$21	\$20	4
S-21264	4⅞ x 2⅝ x 7⅞" (2)			23	22	21	5
S-8534	5 x 3¼ x 9¾" (4)			27	26	25	7
S-8535	6 x 3⅝ x 11" (6)	35 lb.	500	35	34	33	11
S-8536	6⅞ x 4 x 12⅞" (8)			39	38	37	13
S-12364	7⅞ x 4½ x 13¾" (12)	40 lb.	500	56	55	54	18
S-11541	7¾ x 4¾ x 16" (16)			63	61	60	23

FLAT HANDLE

S-18691	12 x 7 x 14" (1/7 BL)	66 lb.	300	\$85	\$80	\$77	38
S-18692	12 x 7 x 17" (1/6 BL)	70 lb.		\$92 per bundle			42

# RECYCLED GROCERY BAGS

Earth-friendly bags for environmentally conscious shoppers.

- Meet most U.S. recycled paper bag requirements. • FDA compliant.
- 100% recycled. Minimum 40% post-consumer content.



KRAFT

MODEL NO.	SIZE W x D x H	BASIS WEIGHT	QTY./ BNDL.	PRICE PER BUNDLE (MIN. 2)			LBS./ BNDL.
				2	5	10+	
S-21265	4⅞ x 2⅝ x 7⅞" (2)	30 lb.	500	\$20	\$19	\$18	5
S-20657	5 x 3¼ x 9¾" (4)			22	21	20	8
S-21266	6 x 4⅞ x 12⅞" (8)	35 lb.	500	36	35	34	12
S-21267	7 x 4⅞ x 13¾" (12)	40 lb.		46	45	44	17
S-20658	12 x 7 x 17" (1/6 BL)	57 lb.		\$91 per bundle			54



## GUSSETED 30-70 LB.

FLAT HANDLE

S-20659	12 x 7 x 17" (1/6 BL)	70 lb.	300	\$92 per bundle			45
---------	-----------------------	--------	-----	-----------------	--	--	----



# MERCHANDISE BAGS



## HIGH DENSITY

High-density bags for lightweight merchandise.

- Embossed surface makes bags easy to open.
- Low-profile dispenser box fits easily under counters.

SPECIFY COLOR: Blue, Dark Green, Teal, Clear, Purple, Pink, Black, White, Burgundy, Red, Orange or Yellow

MODEL NO.	SIZE W x D x L	USABLE DIM. W x L	MIL	QTY./ CTN.	PRICE PER CARTON			LBS./ CTN.
					1	5	10+	
S-9687	7 x 3 x 12"	7 x 9"	.6	1,000	\$28	\$27	\$26	5
S-9688	9 x 3 x 14"	9 x 10½"	.6	1,000	44	42	40	7
S-6856	12 x 3 x 18"	12 x 14"	.7	500	34	33	32	6
S-6857	16 x 4 x 24"	16 x 20"	.7	500	55	50	49	11

- High density resists tears.
- All bags have die-cut handles.
- Available in twelve colors.

# FROSTY MERCHANDISE BAGS

## HIGH DENSITY

Enhance your presentation with these deluxe bags.

- Recommended for beauty products, stationery and gifts.
- Die-cut handles and pinched bottoms.
- Frosty Shoppers, see pages 170-171.

SPECIFY COLOR: Clear, Blue, Purple, Red, Lime or Black

MODEL NO.	SIZE W x D x L	USABLE DIM. W x L	MIL	QTY./ CTN.	PRICE PER CARTON			LBS./ CTN.
					1	5	10+	
S-9709	9 x 12"	9 x 9"			\$42	\$40	\$39	11
S-9710	12 x 15"	12 x 12"	2.5	500	62	59	56	16
S-9711	14 x 3 x 21"	14 x 18"			125	122	119	30



# JUMBO BAGS

## HIGH DENSITY

Haul all your gifts for kids from dollar stores.

- Strong, high-density bags resist punctures and tears.
- Gusseted sides. Large easy-carry handles.



MODEL NO.	DESCRIPTION	SIZE W x D x L	MIL	QTY./ CTN.	PRICE PER CARTON			LBS./ CTN.
					1	5	10+	
S-20693	Clear				\$117	\$110	\$102	
S-20694	White	22 x 12 x 44"	1.0	250	124	116	107	24
S-20695	Black				129	121	112	

# BAG STANDS



Quickly load purchases with convenient bag stand.

- Holds 100 T-shirt bags for easy opening and packing.

MODEL NO.	DIMENSIONS W x D x H	PRICE EACH	
		1	2+
H-614	13 x 13 x 15"	\$65	\$60
H-1306	13 x 13 x 19½"	70	65

# T-SHIRT BAGS

**HIGH DENSITY**



Economical choice to hold books, groceries and T-shirts.

- Strong, high-density gusseted bag resists punctures and tears.
- Large handles for easy carrying. Reusable.

**FREE OFFER!**

Free Bag Stand with \$250+ order of 12" or wider T-Shirt Bags. See page 166.

MODEL NO.	DESCRIPTION	SIZE W x D x L	MIL	QTY./ CTN.	PRICE PER CARTON			LBS./ CTN.
					1	5	10+	
S-6638	Plain White	7 x 5 x 16"	.5	3,000	\$75	\$70	\$65	19
S-8547		10 x 6 x 21"	.5	1,000	40	37	35	11
S-3631		12 x 7 x 22"	.5	1,000	\$41 per carton			12
S-11637		18 x 10 x 30"	.65	500	67	63	59	18
S-13147	Plain Clear	7 x 5 x 16"	.5	3,000	75	70	65	19
S-13148		10 x 6 x 21"	.5	1,000	40	37	35	11
S-7628		12 x 7 x 22"	.5	1,000	\$41 per carton			12
S-11638		18 x 10 x 30"	.65	500	67	63	59	18
S-10562	"Thank You" Script	7 x 5 x 16"	.5	3,000	75	70	65	19
S-3632		12 x 7 x 22"	.5	1,000	\$41 per carton			12
S-14155		18 x 10 x 30"	.65	500	67	63	59	18
S-17559	"Thank You" Black							
S-8526	"Have A Happy Day"							
S-9689	"Thank You"	12 x 7 x 22"	.5	1,000	54	50	47	12
S-11543	American Flag							
S-8527	"Happy Holidays"							

# COLORED T-SHIRT BAGS

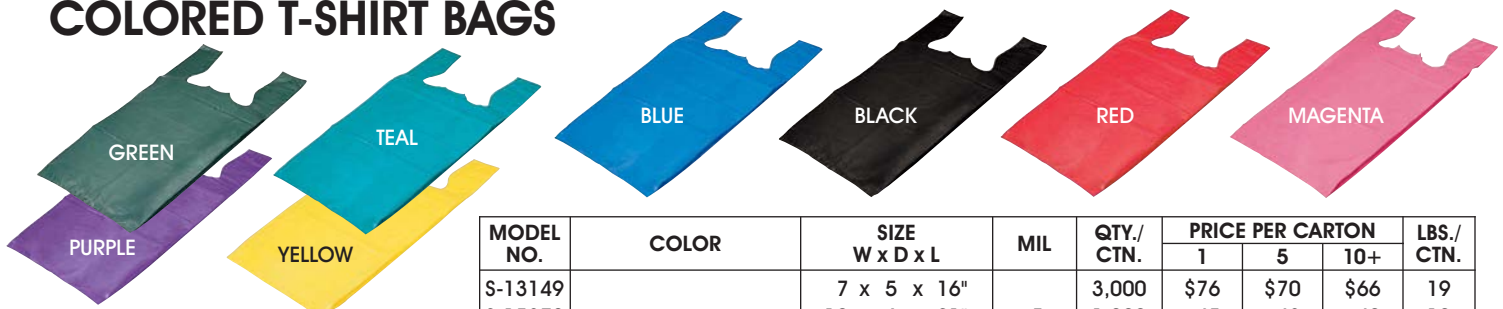

Take advantage of Uline's huge selection of colors and sizes.

MODEL NO.	COLOR	SIZE W x D x L	MIL	QTY./ CTN.	PRICE PER CARTON			LBS./ CTN.
					1	5	10+	
S-13149	Specify	7 x 5 x 16"		3,000	\$76	\$70	\$66	19
S-15379		10 x 6 x 21"	.5	1,000	45	43	40	10
S-9690		12 x 7 x 22"		1,000	55	51	48	12
S-13150		18 x 10 x 30"	.65	500	70	66	62	18

## DELUXE T-SHIRT BAGS



### LOW DENSITY

Opens wide to hold heavy, bulky items.

- Resists punctures and tears.
- Quiet – No grocery store crunch!



SPECIFY COLOR: Clear, White or Black

MODEL NO.	SIZE W x D x L	MIL	QTY./CTN.	PRICE PER CARTON		
				1	5	10+
S-15559	10 x 6 x 21"	1.5	500	\$81	\$77	\$72
S-12349	12 x 7 x 22"			97	92	87
S-12350	20 x 10 x 30"			250	107	102

## ECONOMY T-SHIRT BAGS



### HIGH DENSITY

Thrifty bags hold T-shirts, carryout and loose retail items.

- Gusseted sides. Resists tears.
- Convenient carrying handles.
- "Thank You" script design.

SPECIFY SCRIPT COLOR: Red or Black

MODEL NO.	SIZE W x D x L	MIL	QTY./CTN.	PRICE PER CARTON		
				1	5	10+
S-19027	11½ x 6 x 21"	.5	1,000	\$27 per carton		

## ZIP HANDLE BAGS



### LOW DENSITY

Store, display and sell your products.

- Zipper bag is easy to close.
- Convenient oval-cut handle.
- Reclosable bags complete line, pages 112-123.

SPECIFY COLOR: Clear or White

MODEL NO.	SIZE W x L	USABLE DIM. W x L	MIL	QTY./CTN.	PRICE PER CARTON		
					1	5	10+
S-10712	9 x 14¾"	9 x 12"	3	500	\$64	\$60	\$55
S-10713	13 x 18"	13 x 15"			108	101	91

## CLEAR SHOPPERS



### POLYPROPYLENE

Super clear, gusseted bags shout quality.

- Durable and quiet. No shopping bag crinkle.
- Smooth, sturdy handles make it easy to carry.
- Reinforced chipboard bottom.

MODEL NO.	SIZE W x D x H	MIL	QTY./CTN.	PRICE PER CARTON		
				1	5	10+
S-16690	8 x 4 x 10"	3.5	250	\$92	\$87	\$81
S-16691	10 x 5 x 13"			122	115	108
S-16692	16 x 6 x 12"			167	157	147

## REUSABLE SHOPPING BAGS



### NON-WOVEN POLYPROPYLENE

Get in the habit of using these soft and flexible bags.

- Help our country and our environment.
- Comfortable 28" long handles.
- S-14328 recommended for heavier items. 22" handles.

SPECIFY COLOR: White Black Red Blue Green Lime

MODEL NO.	SIZE W x D x H	WT. (GSM)	QTY./CTN.	PRICE PER CTN.		
				1	5	10+
S-14328	12 x 10 x 14"	90	100	\$195	\$185	\$175
S-14329	16 x 6 x 12"	80		175	165	155
S-14330	20 x 6 x 16"			200	190	180

## COTTON POUCHES



### 100% COTTON

Shabby chic, reusable bags. Natural elegance.

- For vintage-themed gifts, weddings and events.
- Sturdy cotton cord drawstring.

Additional favor bags, page 181

MODEL NO.	SIZE W x L	QTY./BNDL.	PRICE PER BUNDLE		
			1	5	10+
S-24091	4 x 6"	100	\$40	\$35	\$30
S-24092	5 x 7"		45	40	35
S-24093	6 x 10"		65	60	55



# DIE CUT HANDLE BAGS

LOW DENSITY

Super shiny high-gloss bags are perfect for retail and trade shows.

- Reinforced cut-out handle for easy carrying.
- Large size S-9838 recommended for use at trade shows.



SPECIFY COLOR: Teal, Burgundy, Navy, Silver, Orange, Pink, Purple, Red, Green, Clear, Blue, Black, Yellow, Lime Green or White

MODEL NO.	SIZE W x L x D	USABLE DIM. W x L	MIL	QTY./CTN.	PRICE PER CARTON			LBS./CTN.
					1	5	10+	
S-5137	9 x 12"	9 x 9"	1.5	500	\$51	\$48	\$46	7
S-7632	12 x 15"	12 x 12"	1.5		\$55 per carton any qty.			11
S-13156	15 x 18"	15 x 15"	2.0		108	100	94	21
S-5138	11 x 15 x 3"	11 x 12"	1.5	500	67	65	61	12
S-15385	15 x 18 x 4"	15 x 15"	2.0		108	100	94	25
S-5139	16 x 19 x 3"	16 x 16"	2.0		\$105 per carton any qty.			26
S-5477	18 x 19 x 3"	18 x 16"	2.0		121	116	110	28
S-6639	20 x 20 x 5"	20 x 17"	2.0	250	84	80	77	19
S-9838	24 x 24 x 5"	24 x 21"			119	112	108	24
S-13157	12 x 15"	Assorted Colors		500	78	74	69	11

Assorted Colors – S-13157 Includes 40 each: Silver, Orange, Pink, Purple, Red, Green, Blue, Black, Yellow and Lime Green. 50 Each: Clear and White.

# DRAW CORD BAGS

LOW DENSITY

MODEL NO.	SIZE W x L x D	COLOR	MIL	QTY./CTN.	PRICE PER CARTON			LBS./CTN.
					1	5	10+	
S-11544	11 x 16 x 4"	Clear	2.2	500	\$140	\$129	\$122	21
S-10565	16 x 18 x 4"			500	189	178	171	26
S-15386	18 x 20 x 4"			250	127	122	111	17
S-11545	20 x 24 x 4"			250	152	145	137	21
S-6642	11 x 16 x 4"	White	2.2	500	146	137	128	21
S-6643	16 x 18 x 4"			500	195	187	176	26
S-15387	18 x 20 x 4"			250	135	127	120	17
S-10564	20 x 24 x 4"			250	158	152	143	21
S-13158	11 x 16 x 4"	Red or Black	2.2	500	149	139	130	21
S-13159	16 x 18 x 4"			500	197	190	178	26
S-13160	20 x 24 x 4"			250	162	155	145	21



Easy-close draw cord protects everything from shoes to promotional items.



SPECIFY COLOR: White, Clear, Black or Red

# SNAP-SEAL HANDLE BAGS

LOW DENSITY

Popular low-density bags ideal for trade shows, seminars and promotions.

- Snap-seal handle secures contents.
- Choose from two colors – Clear or White.



CLEAR

MODEL NO.	SIZE W x L x D	COLOR	MIL	QTY./CTN.	PRICE PER CARTON			LBS./CTN.
					1	5	10+	
S-6640	15 x 17 x 3"	Clear	1.75	250	\$150	\$137	\$126	16
S-6641	20 x 20 x 5"				169	163	155	21
S-5478	15 x 17 x 3"	White	1.75	250	151	138	127	16
S-5479	20 x 20 x 5"				170	164	156	21



# FROSTY DIE CUT BAGS

HIGH DENSITY



Tough merchandise totes with a dash of style.

- Slotted, die-cut handles and gusseted sides.
- Reinforced gusseted cardboard bottom for strength.



## CLEAR

MODEL NO.	BAG NAME	SIZE W x D x H	MIL	QTY./ CTN.	PRICE PER CARTON			LBS./ CTN.
					1	3	6+	
S-13154	Wine	5½ x 3 x 15"	3.5	250	\$68	\$65	\$62	14
S-11546	Cub	7 x 3½ x 10½"			62	58	55	12
S-11547	Double Wine	7¾ x 3½ x 15"	4	250	70	67	64	17
S-13155	Debbie	10 x 5 x 13"			105	100	96	25
S-11548	Queen	16 x 6 x 15"			144	136	130	39

## COLORED

SPECIFY COLOR: Purple, Lime Green or Blue

S-11549	Cub	7 x 3½ x 10½"	3.5	250	\$68	\$65	\$62	12
S-11550	Double Wine	7¾ x 3½ x 15"	4		80	76	73	17
S-11551	Queen	16 x 6 x 15"		153	146	138	39	

# WINE CARRIERS

Safely carry and showcase your finest vintages in elegant totes.

- Die-cut windows and carrying handle.
- Ships flat for easy storage. Sturdy corrugated totes assemble in seconds.



Recommended for wineries and gift shops.

MODEL NO.	COLOR	SIZE L x W x H	HOLDS # BTLs.	QTY./ CTN.	PRICE PER CARTON		LBS./ CTN.
					1	5+	
S-24076	Kraft	3½ x 3½ x 15"	1	50	\$80	\$75	12
S-22232		7 x 3 x 15"	2	30	85	80	12
S-22233		10% x 3½ x 15"	3	30	110	105	17
S-22234	Black Linen or Red Pebble	7 x 3 x 15"	2	30	90	85	12
S-22235		10% x 3½ x 15"	3	30	120	115	17

# REUSABLE BAGS

NON-WOVEN POLYPROPYLENE

Soft, flexible bags for groceries, books or apparel.

## DIE CUT

- Strong, heat-sealed construction.
- Reinforced handle for easy carrying.

## T-SHIRT

- Gusseted sides. Durable heat seal construction.
- Long handles slide over bag stands for easy filling.



SPECIFY COLOR: Black, Blue or Red

MODEL NO.	SIZE W x L x D	WT. (GSM)	QTY./ CTN.	PRICE PER CARTON			LBS./ CTN.
				1	5	10+	
S-25241	10 x 12"	80	100	\$120	\$115	\$110	5
S-25242	12 x 15"			130	125	120	7
S-25243*	15 x 18 x 4"			150	145	140	10

\* Gusseted bottom

SPECIFY COLOR: Black, Blue or Red

MODEL NO.	SIZE W x L x D	WT. (GSM)	QTY./ CTN.	PRICE PER CARTON			LBS./ CTN.
				1	5	10+	
S-25122	12 x 22 x 7"	60	100	\$55	\$53	\$50	10

# FROSTY SHOPPERS



Deluxe, heavy-duty 4 mil bags enhance your presentation.

- Soft, flexible handles are comfortable for heavy purchases.
- Side gussets expand for bulkier merchandise.
- Durable reinforced chipboard bottom.

## CLEAR

MODEL NO.	BAG NAME	SIZE W x D x H	MIL	QTY./CTN.	PRICE PER CARTON			LBS./CTN.
					1	3	6+	
S-12424C	Wine	5¼ x 3¼ x 13"	4	250	\$75	\$71	\$68	17
S-9697C	Rose	5¼ x 3¼ x 8⅝"			65	62	58	12
S-7257C	Cub	8 x 5 x 10"			<b>\$69 per carton any qty.</b>			20
S-8578C	Debbie	10 x 5 x 13"			108	102	97	28
S-12425C	Marl	13 x 7 x 17"			164	157	149	41
S-7258C	Vogue	16 x 6 x 12"			126	120	114	38
S-7259C	Queen	16 x 6 x 16"	158	150	143	45		
S-9698C	Jumbo	18 x 7 x 19"	4	200	174	165	157	48
S-12426C	Magnum	24 x 7¼ x 18¾"			173	164	156	46



Eye-catching colored bags add a dramatic look to purchases.

- Pair up with coordinating tissue paper, page 183.



## COLORED

SPECIFY COLOR: ■ Pink ■ Blue ■ Purple ■ Lime ■ Red ■ Yellow D. ■ Green ■ Orange ■ Black ■ Chocolate

MODEL NO.	BAG NAME	SIZE W x D x H	MIL	QTY./CTN.	PRICE PER CARTON			LBS./CTN.
					1	3	6+	
S-9697	Rose	5¼ x 3¼ x 8⅝"	4	250	\$75	\$71	\$68	12
S-7257	Cub	8 x 5 x 10"			<b>\$78 per carton any qty.</b>			20
S-8578	Debbie	10 x 5 x 13"			119	114	109	28
S-7258	Vogue	16 x 6 x 12"			140	134	127	38
S-7259	Queen	16 x 6 x 16"			163	155	148	45
S-11557	Jumbo	18 x 7 x 19"			216	206	198	48





Quick and easy gift packaging. Perfect for gifts, dishware and retail products.

- Simple one piece fold-and-tuck construction.
- Gloss finish boxes have light matte interior.
- FDA/USDA compliant for use with food.
- Ships flat to save on freight and storage space.
- 100% recycled content.
- Add colorful Tissue Paper, see pages 182 and 183.

## KRAFT PINSTRIPE

MODEL NO.	SIZE L x W x H	RECOMMENDED USE	QTY./CASE	PRICE PER CASE		
				1	5	10+
S-11612	2 x 2 x 2"	Small Figurine	100	\$16	\$15	\$14
S-10625	3 x 3 x 2"	Ornament		17	16	15
S-10626	3 x 3 x 3"	Candle		19	18	17
S-13219	3 x 3 x 4"	Coasters		21	20	19
S-11613	4 x 4 x 2"	Novelties	100	23	22	21
S-11614	4 x 4 x 3"	Ceramics		28	27	26
S-9601	4 x 4 x 4"	Cup		\$21/case any qty.		
S-13220	4 x 4 x 6"	Mug		28	27	25
S-12457	5 x 5 x 3½"	Belts, Frames	100	30	29	28
S-11615	5 x 5 x 5"	Bowl		33	32	31
S-10627	6 x 4½ x 4½"	Corsage, Dish		31	30	29
S-10628	6 x 6 x 4"	Clocks	100	53	51	49
S-9602	6 x 6 x 6"	Bowl		51	49	47
S-11616	7 x 7 x 7"	Cookie Jar		74	72	69
S-13221	8 x 8 x 4"	Mug Set, Bowl		67	65	63
S-16819	8 x 8 x 6"	Handbag	50	57	55	53
S-16820	9 x 4½ x 4½"	Goblets	100	66	64	62
S-16821	10 x 4½ x 4½"	Small Lamp		57	55	53
S-12458	12 x 6 x 6"	Vase		81	79	76

## BLACK GLOSS

S-10629	2 x 2 x 2"	Small Figurine	100	\$24	\$23	\$22
S-10630	3 x 3 x 3"	Candle		28	27	26
S-11618	4 x 4 x 2"	Novelties	100	35	34	33
S-8554	4 x 4 x 4"	Cup		37	36	35
S-13229	4 x 4 x 6"	Mug		39	38	37
S-12459	5 x 5 x 3½"	Belts, Frames		38	37	36
S-12460	5 x 5 x 5"	Bowl	100	44	42	40
S-10631	6 x 4½ x 4½"	Corsage, Dish		41	40	39
S-8555	6 x 6 x 6"	Bowl		67	65	63
S-13230	8 x 8 x 4"	Mug Set, Bowl		87	85	83

## RED GLOSS

S-15491	3 x 3 x 3"	Candle	100	\$30	\$29	\$28
S-13233	4 x 4 x 4"	Cup		41	40	39
S-13235	6 x 6 x 6"	Bowl	100	71	69	67
S-16826	8 x 8 x 4"	Mug Set, Bowl		90	88	86

## WHITE GLOSS

MODEL NO.	SIZE L x W x H	RECOMMENDED USE	QTY./CASE	PRICE PER CASE		
				1	5	10+
S-9691	2 x 2 x 2"	Small Figurine	100	\$17	\$16	\$15
S-12453	2 x 2 x 4"	Novelties		24	23	22
S-7633	3 x 3 x 2"	Ornament		\$15/case any qty.		
S-9597	3 x 3 x 3"	Candle		21	20	19
S-10616	3 x 3 x 4"	Coasters	100	22	21	20
S-16852	3 x 3 x 6"	Glass		38	37	36
S-13222	4 x 2 x 2"	Candles	100	26	25	24
S-9598	4 x 4 x 2"	Novelties		24	23	22
S-11607	4 x 4 x 3"	Ceramics		26	25	24
S-7087	4 x 4 x 4"	Cup		\$22/case any qty.		
S-11608	4 x 4 x 6"	Mug	100	31	30	29
S-13223	4 x 4 x 7"	Figurines		51	49	47
S-16853	5 x 5 x 2"	Candies	100	51	49	47
S-9692	5 x 5 x 3½"	Belts, Frames		35	34	33
S-11609	5 x 5 x 5"	Bowl		37	36	35
S-7088	6 x 4½ x 4½"	Corsage, Dish		37	36	35
S-9599	6 x 6 x 4"	Clocks	100	53	51	49
S-7089	6 x 6 x 6"	Bowl		56	54	52
S-13225	7 x 3 x 3"	Bud Vase	100	44	42	40
S-7090	7 x 7 x 7"	Cookie Jar	100	94	92	90
S-9693	8 x 8 x 4"	Mug Set, Bowl	100	83	81	79
S-7091	8 x 8 x 6"	Handbag	50	58	56	54
S-12454	8½ x 8½ x 8½"	Deep Bowl	50	73	71	69
S-11610	9 x 4 x 4"	Tumblers	100	59	57	55
S-12455	9 x 5 x 4"	Med. Corsage	100	65	63	61
S-10617	9 x 6 x 6"	Figurines	100	96	94	92
S-9600	10 x 4½ x 4½"	Small Lamp	100	65	63	61
S-10618	10½ x 10½ x 5½"	Stemware	50	79	77	75
S-11611	11 x 3 x 3"	Pillar Candles	100	56	54	52
S-7092	12 x 6 x 6"	Vase	100	126	124	122
S-12456	12 x 12 x 5½"	Glasses	50	127	124	120

# COLORED MAILERS

HIGH GLOSS CORRUGATED



Eliminate the need for gift wrap with our attractive mailers.

- Ships flat. Sets up in seconds. Tab locking.
- High gloss exterior. Kraft interior.
- Strong 200 lb. test corrugated.

SOLD IN BUNDLE QUANTITIES

MODEL NO.	INSIDE DIM. L x W x H	COLOR	QTY./ BNDL.	PRICE PER MAILER		
				25	100	500+
S-16840	4 x 4 x 4"	Black, Green, Navy, Red or White Gloss	25	\$1.95	\$1.75	\$1.65
S-15482	6 x 6 x 1"			2.05	1.85	1.70
S-23462	6 x 6 x 3"			2.65	2.50	2.40
S-13215*	8 x 8 x 3"			3.20	3.05	2.90
S-19114	8 x 8 x 8"			7.00	6.65	6.30
S-23463	9 x 6½ x 1¾"			2.70	2.60	2.45
S-12694*	9 x 6½ x 2¾"			3.20	3.05	2.90
S-19115	9 x 6½ x 4"			3.45	3.30	3.20
S-13216	10 x 10 x 5"			4.70	4.60	4.30
S-12695*	11½ x 8¾ x 2"			3.30	3.20	3.05

\*Also available in Chocolate

SOLD IN BUNDLE QUANTITIES

MODEL NO.	INSIDE DIM. L x W x H	COLOR	QTY./ BNDL.	PRICE PER MAILER		
				25	100	500+
S-14191	11½ x 8¾ x 4"	Black, Green, Navy, Red or White Gloss	25	\$5.30	\$5.20	\$4.90
S-19116	12 x 12 x 2"			5.55	5.25	5.05
S-12696*	12 x 12 x 4"			6.20	5.90	5.55
S-23464	12 x 12 x 6"			6.95	6.55	6.20
S-13217*	12½ x 9¾ x 4"			5.90	5.55	5.20
S-14192	13 x 10 x 2"			4.10	3.80	3.60
S-19117	13 x 10 x 4"			6.10	5.75	5.30
S-15483*	14 x 10 x 6"			6.30	6.10	5.75
S-23465	16 x 16 x 4"			6.40	6.20	5.85
S-16841	19 x 12 x 3"			6.45	6.20	5.90

Literature Mailers, see pages 77-81

# HOLIDAY MAILERS

GORGEOUS GLOSS EXTERIOR

Ready for gift giving with attractive seasonal designs.

- Ships flat. Sets up in a snap.
- Strong 200 lb. test corrugated.

GLOSS EXTERIOR

SOLD IN BUNDLE QUANTITIES

MODEL NO.	INSIDE DIM. L x W x H	DESCRIPTION	QTY./ BNDL.	PRICE PER MAILER		
				25	100	500+
S-21666	8 x 8 x 3"	Red Bow or Holiday Tree	25	\$3.25	\$3.10	\$3.00
S-21667	10 x 10 x 5"			5.00	4.80	4.60
S-21668	12 x 12 x 4"			6.55	6.15	5.75
S-21669	16 x 16 x 4"			6.75	6.55	6.15



# HAT/WREATH BOXES

Two-piece chipboard box with matte white exterior.

MODEL NO.	SIZE L x W x H	DESCRIPTION	QTY./ CASE	PRICE PER CASE		
				1	5	10+
S-7979	12 x 12 x 6"	Hat/Wreath	50	\$182	\$176	\$171
S-7959	14 x 14 x 7"			120	117	112
S-7960	16 x 16 x 7"			140	134	129
S-9809	18 x 18 x 7"			161	155	150



- Includes carrying cord.
- Ships flat to save on shipping.

# DELUXE GIFT BOXES

HI-WALL



Upscale presentation for fine merchandise.

- Rigid lid construction, twice as strong as chipboard.
- Gloss exterior lid, white interior.
- Pre-assembled rigid lid.
- Chipboard base ships flat. Kraft interior, matte exterior.

## WHITE

MODEL NO.	SIZE L x W x H	RECOMMENDED USE	QTY./CASE	PRICE PER CASE		
				1	5	10+
S-10619	4 x 4 x 3"	Novelties	50	\$81	\$77	\$73
S-10620	4 x 4 x 6"	Mugs, Cups		88	86	83
S-11593	4 x 4 x 15"	Liquor Bottle		117	113	109
S-10621	6 x 6 x 3"	Stemware, China		103	99	95
S-10622	6 x 6 x 6"	Clock, Bowl		117	113	109
S-11594	8 x 8 x 3"	Wine Glasses		138	133	130
S-11595	8 x 8 x 6"	Salad Bowl		152	147	136
S-13211	10 x 5 x 3"	Goblets, Pottery	50	134	130	128
S-10623	10 x 10 x 3"	Plates, Pottery		165	158	153
S-10624	10 x 10 x 6"	Glassware, Bowls		190	183	177
S-11596	12 x 12 x 3"	Serving Bowl		259	250	242

## WHITE CONTINUED

MODEL NO.	SIZE L x W x H	RECOMMENDED USE	QTY./CASE	PRICE PER CASE		
				1	5	10+
S-11597	12 x 12 x 6"	Glasses	50	\$293	\$287	\$275
S-11598	12 x 12 x 12"	Cocktail Set		374	361	347
S-13212	14 x 14 x 3"	Cake Plate		323	314	300
S-13213	14 x 14 x 6"	Relish Tray		352	337	333
S-13214	19 x 12 x 3"	Serving Tray		402	387	372
S-12690	19 x 12 x 6"	Blanket		447	432	419

## BLACK

S-15495	4 x 4 x 3"	Novelties	50	\$146	\$138	\$132
S-24098	6 x 6 x 3"	Stemware, China		182	176	167
S-15496	8 x 8 x 3"	Wine Glasses		239	228	219
S-15497	10 x 10 x 3"	Plates, Pottery		293	277	267



## CLEAR TOP JEWELRY BOXES

Protect jewelry and small fragile items.

- Non-tarnishing white polyester fiber included.
- White swirl or kraft chipboard base with a clear plastic lid.

\*Also available in Kraft

MODEL NO.	SIZE L x W x H	RECOMMENDED USE	QTY./CASE	PRICE PER CASE		
				1	5	10+
S-10582	2 <sup>1</sup> / <sub>16</sub> x 1 <sup>1</sup> / <sub>8</sub> x 13/16"	Earrings	100	\$37	\$35	\$33
S-13204	3 x 2 <sup>1</sup> / <sub>8</sub> x 1"	Pin, Earrings		42	40	38
S-12392*	3 <sup>1</sup> / <sub>2</sub> x 3 <sup>1</sup> / <sub>2</sub> x 7/8"	Bracelet		49	47	45
S-10583	3 <sup>1</sup> / <sub>2</sub> x 3 <sup>1</sup> / <sub>2</sub> x 1 <sup>1</sup> / <sub>8</sub> "	Wide Bracelet		60	58	56
S-10584*	5 <sup>1</sup> / <sub>16</sub> x 3 <sup>1</sup> / <sub>2</sub> x 1"	Necklace		64	61	59
S-13205*	7 x 5 x 1 <sup>1</sup> / <sub>4</sub> "	Earrings, Necklace		101	99	97



## RING BOXES

Attractively display and protect rings. Foam insert keeps ring in place.

- White swirl or black embossed chipboard lid and base.

Velvet Boxes and Displays, see [uline.com](http://uline.com)



SPECIFY COLOR: White or Black

MODEL NO.	SIZE L x W x H	DESCRIPTION	QTY./CASE	PRICE PER CASE		
				1	5	10+
S-10600	1 <sup>5</sup> / <sub>8</sub> x 1 <sup>5</sup> / <sub>8</sub> x 1 <sup>1</sup> / <sub>4</sub> "	Ring Box	100	\$55	\$53	\$51



## COTTON INSERTS

Soft white deluxe inserts for jewelry and gift boxes.

- Anti-tarnishing.
- Won't absorb moisture.
- Spun fiber polyester.

MINIMUM 2 CASES

MODEL NO.	SIZE L x W	RECOMMENDED BOX USE	QTY./CASE	PRICE PER CASE		
				2	5	10+
S-11603	2 <sup>1</sup> / <sub>16</sub> x 1 <sup>5</sup> / <sub>8</sub> "	Earrings	100	\$15	\$14	\$13
S-11604	3 <sup>1</sup> / <sub>16</sub> x 3 <sup>1</sup> / <sub>16</sub> "	Bracelet		20	19	17
S-11605	5 <sup>1</sup> / <sub>4</sub> x 3 <sup>3</sup> / <sub>4</sub> "	Necklace		30	28	25
S-11606	7 x 5 <sup>1</sup> / <sub>2</sub> "	Earrings, Necklace		46	42	37
S-15498	8 x 2"	Watch		31	28	25
S-15499	8 x 5 <sup>1</sup> / <sub>16</sub> "	Large Necklace		51	47	42



# JEWELRY BOXES

COMPLETE LINE, SEE [ULINE.COM](http://ULINE.COM)

TWO PIECE

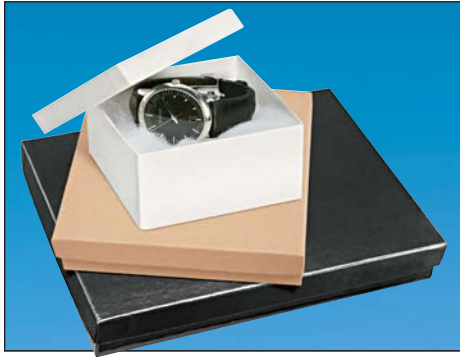

Package and protect your finest jewelry.

- Rigid chipboard, pre-assembled. White cotton non-tarnishing polyester fiber included.

## WHITE SWIRL

MODEL NO.	SIZE L x W x H	RECOMMENDED USE	QTY./CASE	PRICE PER CASE		
				1	5	10+
S-11516	1 3/4 x 1 1/8 x 5/8"	Charm	100	\$41	\$39	\$35
S-7277	2 1/2 x 1 1/2 x 7/8"	Earrings	100	41	39	35
S-8560	3 1/8 x 2 1/8 x 1"	Pin, Earrings	100	51	48	44
S-7278	3 1/2 x 3 1/2 x 1"	Bracelet	100	56	53	51
S-8561	3 1/2 x 3 1/2 x 1 1/2"	Wide Bracelet	100	59	56	53
S-13063	3 1/2 x 3 1/2 x 2"	Wider Bracelet	100	68	65	63
S-12384	4 x 4 x 1"	Large Pin	100	70	67	64
S-12385	4 3/8 x 3 3/4 x 1 1/8"	Bracelet	100	68	65	63
S-7279	5 1/4 x 3 3/4 x 7/8"	Necklace	100	63	61	57
S-13064	5 1/4 x 3 3/4 x 1 3/4"	Medium Necklace	100	68	65	63
S-11517	6 x 5 x 1"	Earring Set	50	57	55	52
S-9607	7 x 5 1/2 x 1"	Earrings/Necklace	50	59	56	53
S-7280	8 x 2 x 7/8"	Watch	100	61	57	55
S-15428	8 x 5 1/2 x 1 1/4"	Large Necklace	50	61	57	55
S-10601	8 x 5 1/2 x 2"	Beaded Necklace	50	65	63	61
S-12386	9 3/4 x 1 1/8 x 1 1/4"	Men's Watch	50	56	53	51

## WHITE GLOSS

MODEL NO.	SIZE L x W x H	RECOMMENDED USE	QTY./CASE	PRICE PER CASE		
				1	5	10+
S-9810	2 1/2 x 1 1/2 x 7/8"	Earrings	100	\$41	\$39	\$35
S-13065	3 1/8 x 2 1/8 x 1"	Pin, Earrings	100	51	48	44
S-9811	3 1/2 x 3 1/2 x 1"	Bracelet	100	56	53	51
S-15422	3 1/2 x 3 1/2 x 2"	Wider Bracelet	100	68	65	63
S-9812	5 1/4 x 3 3/4 x 7/8"	Necklace	100	63	61	57
S-12387	7 x 5 1/2 x 1"	Earrings/Necklace	50	59	56	53
S-13066	8 x 2 x 7/8"	Watch	100	61	57	55

## BLACK GLOSS

S-12388	2 1/2 x 1 1/2 x 7/8"	Earrings	100	\$63	\$61	\$57
S-12389	3 1/8 x 2 1/8 x 1"	Pin, Earrings	100	70	67	64
S-12390	3 1/2 x 3 1/2 x 1"	Bracelet	100	84	81	77
S-15423	3 1/2 x 3 1/2 x 2"	Wider Bracelet	100	97	95	92
S-14340	4 x 4 x 1"	Large Pin	100	123	120	118
S-12391	5 1/4 x 3 3/4 x 7/8"	Necklace	100	97	95	88
S-13069	7 x 5 1/2 x 1"	Earrings/Necklace	50	81	77	75
S-13070	8 x 2 x 7/8"	Watch	100	85	80	76

## KRAFT

S-9813	2 1/2 x 1 1/2 x 7/8"	Earrings	100	\$41	\$39	\$35
S-10602	3 1/8 x 2 1/8 x 1"	Pin, Earrings	100	51	48	44
S-9814	3 1/2 x 3 1/2 x 1"	Bracelet	100	56	53	51
S-10603	3 1/2 x 3 1/2 x 1 1/2"	Wide Bracelet	100	59	56	53
S-15429	3 1/2 x 3 1/2 x 2"	Wider Bracelet	100	70	67	64
S-14339	4 x 4 x 1"	Large Pin	100	70	67	64
S-10604	5 1/4 x 3 3/4 x 7/8"	Necklace	100	63	61	57
S-13067	6 x 5 x 1"	Earring Set	50	57	55	52
S-10605	7 x 5 1/2 x 1"	Earrings/Necklace	50	61	57	55
S-9815	8 x 2 x 7/8"	Watch	100	62	59	56
S-21197	8 x 5 1/2 x 1 1/4"	Large Necklace	50	61	57	55
S-13068	8 x 5 1/2 x 2"	Beaded Necklace	50	65	63	61

## BLACK MATTE

S-24025	3 1/8 x 2 1/8 x 1"	Pin, Earrings	100	\$69	\$67	\$64
S-24026	3 1/2 x 3 1/2 x 1"	Bracelet	100	83	80	76
S-24027	5 1/4 x 3 3/4 x 7/8"	Necklace	100	97	95	88
S-24028	7 x 5 1/2 x 1"	Earrings/Necklace	50	81	77	75

## GOLD OR SILVER LINEN

SPECIFY COLOR

S-13077	1 3/4 x 1 1/8 x 5/8"	Charm	100	\$48	\$46	\$44
S-8562	2 1/2 x 1 1/2 x 7/8"	Earrings	100	51	48	46
S-13078	3 1/8 x 2 1/8 x 1"	Pin, Earrings	100	58	56	53
S-8563	3 1/2 x 3 1/2 x 1"	Bracelet	100	68	65	63
S-9816	5 1/4 x 3 3/4 x 7/8"	Necklace	100	74	72	69
S-9817	8 x 2 x 7/8"	Watch	100	73	70	68

# APPAREL BOXES

TWO PIECE



Pop-up style box instantly folds into place. Holds various sizes of clothing.

- Chipboard exterior with gray/kraft interior.
- Ships flat to save on freight and storage space.

## WHITE GLOSS

MODEL NO.	SIZE L x W x H	RECOMMENDED USE	QTY./CASE	PRICE PER CASE		
				1	5	10+
S-8556	10 x 7 x 1½"	Linens, Small Blouse	100	\$58	\$57	\$56
S-7093	11½ x 8½ x 1½"	Children's Clothes	100	63	62	59
S-10614	12 x 12 x 4"	Tablecloth	50	91	88	86
S-7094	15 x 9½ x 2"	Men's Shirt	100	74	72	68
S-7095	17 x 11 x 2½"	Dress, Sweater	50	57	56	54
S-7096	19 x 12 x 3"	Robe, Jacket	50	74	72	69
S-8559	24 x 14 x 4"	Coat, Blanket	25	66	63	59

## BLACK GLOSS

MODEL NO.	SIZE L x W x H	RECOMMENDED USE	QTY./CASE	PRICE PER CASE		
				1	5	10+
S-13060	11½ x 8½ x 1½"	Children's Clothes	100	\$65	\$64	\$63
S-11513	15 x 9½ x 2"	Men's Shirt	100	80	77	74
S-11514	17 x 11 x 2½"	Dress, Sweater	50	62	59	58
S-11515	19 x 12 x 3"	Robe, Jacket	50	81	79	77
S-14153	24 x 14 x 4"	Coat, Blanket	25	72	68	66

## KRAFT PINSTRIPE

MODEL NO.	SIZE L x W x H	RECOMMENDED USE	QTY./CASE	PRICE PER CASE		
				1	5	10+
S-16842	10 x 7 x 1½"	Linens, Small Blouse	100	\$58	\$57	\$56
S-10598	11½ x 8½ x 1½"	Children's Clothes	100	58	57	56
S-7634	15 x 9½ x 2"	Men's Shirt	100	73	70	67
S-7635	17 x 11 x 2½"	Dress, Sweater	50	54	53	52
S-12382	19 x 12 x 3"	Robe, Jacket	50	70	67	64
S-13059	24 x 14 x 4"	Coat, Blanket	25	62	58	56

# TIE BOXES

TWO PIECE



Elegant boxes for ties and scarves.

- Pre-assembled, rigid chipboard.

MODEL NO.	SIZE L x W x H	COLOR	QTY./CASE	PRICE PER CASE		
				1	5	10+
S-10615	14 x 4½ x ¾"	White	100	\$101	\$98	\$94
S-12383		Black		134	129	123

# SHOE BOXES

TWO PIECE



Universal sizes for storing shoes, small items and photos.

- Sturdy, chipboard construction – Double wall sides and ends.
- Separate lid and base.
- Ships flat. Quick, easy assembly.

## WHITE GLOSS OR KRAFT

MODEL NO.	SIZE L x W x H	RECOMMENDED USE	QTY./CASE	PRICE PER CASE		
				1	5	10+
S-13062	8 x 6 x 3"	Toddler/Baby Shoes	25	\$48	\$44	\$38
S-11570	9 x 7 x 4"	Children's Shoes		50	46	42
S-10585	12 x 7 x 4"	Women's Shoes		51	47	43
S-10586	14 x 8 x 5"	Men's Shoes		63	59	55
S-11571	14 x 10 x 5"	Boots		66	62	58

## BLACK GLOSS

MODEL NO.	SIZE L x W x H	RECOMMENDED USE	QTY./CASE	PRICE PER CASE		
				1	5	10+
S-13061	12 x 7 x 4"	Women's Shoes	25	\$61	\$57	\$53
S-15401	14 x 8 x 5"	Men's Shoes		73	69	65

# HIGH GLOSS GIFT BOXES

TWO PIECE



An upscale box for the finest gifts in boutiques and galleries.

- Matching glossy lid and reinforced base.
- Corrugated.
- Ships flat. Easy assembly.

MODEL NO.	SIZE L x W x H	DESCRIPTION	QTY./CASE	PRICE PER CASE		
				1	5	10+
S-22267	6 x 6 x 5"	White Gloss	50	\$112	\$110	\$108
S-22268	8 x 8 x 6"		50	165	161	156
S-22269	10 x 10 x 8"		30	141	136	132
S-22270	6 x 6 x 5"	Black Gloss	50	132	130	127
S-22271	8 x 8 x 6"		50	193	187	182
S-22272	10 x 10 x 8"		30	163	158	154

# CLEAR LID BOXES



Display and package greeting cards, stationery and picture frames.

- Clear vinyl lids fit over white or kraft rigid chipboard or clear vinyl bases. • Gold and Black, see [uline.com](http://uline.com)

## WHITE

MODEL NO.	SIZE L x W x H	RECOMMENDED USE	QTY./CTN.	PRICE PER CARTON		
				1	2	4+
S-12543	5¼ x 4½ x 3/4"	Greeting Cards	50	\$50	\$48	\$46
S-9822	6½ x 4½ x 2"	Bulk Notes	50	69	67	65
S-7282	7½ x 5½ x 1"	Greeting Cards	50	57	55	53
S-9823	7½ x 5½ x 2"	Bulk Greeting Cards	25	40	39	37
S-7283	8½ x 5½ x 1½"	Large Cards	50	64	62	61
S-9824	8½ x 5½ x 2"	Bulk Large Cards	25	41	40	38
S-8542	9½ x 6½ x 1½"	Invitations	50	74	72	69
S-7284	10 x 7 x 2"	Frames	50	76	74	71
S-8543	11¼ x 8¾ x 2"	Letterhead, Scarf	20	37	36	35
S-10576	12 x 12 x 2"	Apparel, Book	10	46	44	41

## CLEAR

MODEL NO.	SIZE L x W x H	RECOMMENDED USE	QTY./CTN.	PRICE PER CARTON		
				1	2	4+
S-10577	3¾ x 3¾ x 2"	Votives, Bus. Cards	200	\$140	\$133	\$125
S-10578	5½ x 5½ x 1"	Pillar Candles	200	145	138	130
S-10579	5¼ x 4½ x 3/4"	Greeting Cards	200	125	118	110
S-9725	6½ x 4¾ x 3/4"	Notes, Gloves	200	135	128	120
S-9726	7½ x 5½ x 1"	Greeting Cards	200	143	136	128
S-12542	11¼ x 8¾ x 2"	Letterhead, Scarf	50	80	78	75

## KRAFT

S-21240	5¼ x 4½ x 3/4"	Greeting Cards	50	\$46	\$45	\$42
S-21241	7½ x 5½ x 1"	Greeting Cards	50	53	51	48
S-21242	7½ x 5½ x 2"	Bulk Greeting Cards	25	37	35	33

# CORRUGATED SHOE BOXES

## KRAFT

MODEL NO.	SIZE L x W x H	RECOMMENDED USE	QTY./BNDL.	PRICE EACH (MIN. 25)		
				25	100	250+
S-17334	12 x 7 x 4"	Women's Shoes	25	\$2.20	\$2.05	\$1.75
S-17335	13 x 8 x 5"	Men's Shoes		2.40	2.15	1.95

## WHITE

MODEL NO.	SIZE L x W x H	RECOMMENDED USE	QTY./BNDL.	PRICE EACH (MIN. 25)		
				25	100	250+
S-17336	12 x 7 x 4"	Women's Shoes	25	\$2.40	\$2.15	\$1.95
S-17337	13 x 8 x 5"	Men's Shoes		2.60	2.25	2.10

Strong one-piece box for shipping or storing shoes.

- Sturdy, corrugated construction.
- 32 ECT E flute.
- Ships flat. Quick, easy assembly.



ONE PIECE

# PLASTIC SHOE BOXES

See-through protection for shoes, boots and store supplies.

- Durable polypropylene construction. Moisture resistant.
- Secure snap-on lid. Recessed handles.

MADE IN THE USA

MODEL NO.	SIZE L x W x H	RECOMMENDED USE	QTY./CTN.	PRICE PER CARTON		
				1	3	5+
S-15402	13 x 8 x 5"	Women's Shoes	12	\$37	\$36	\$33
S-15403	16 x 12 x 7"	Men's Shoes/Boots		77	74	70



Additional Storage Containers, see page 220.



Sterilite®





## DEEP METAL TINS

Packaging for your candies, spices or teas.

- Popular metal tins in fun shapes and sizes.
- Tin plate. Seamless construction.
- Snug-fitting, slip-on lid.
- FDA compliant.

**Solid Lids** – Protect herbs, spices and other light-sensitive products.

**Window Lids** – Clear top lets you easily view the products inside.



### ROUND SOLID LID

\*Also available in Gold and Black

MODEL NO.	DIMENSIONS DIAM. x H	CAPACITY	QTY./ CTN.	PRICE PER CARTON		
				1	2	4+
S-20649	1½ x 1"	1 oz.	48	\$33	\$31	\$29
S-17905*	2 x 1½"	2 oz.		34	32	30
S-17906*▲	2½ x 1¾"	4 oz.		43	40	36
S-23235*	2¾ x 2"	6 oz.		57	54	51
S-19908*▲	3½ x 2"	8 oz.		59	56	53
S-23236	3¾ x 2"	10 oz.		65	61	57
S-17907*	3¾ x 2½"	14 oz.		70	66	61
S-23423*	4 x 2½"	16 oz.		80	74	69

▲ Also available in White

### ROUND WINDOW LID

\*Also available in Gold and Black

MODEL NO.	DIMENSIONS DIAM. x H	CAPACITY	QTY./ CTN.	PRICE PER CARTON		
				1	2	4+
S-20650	1½ x 1"	1 oz.	48	\$41	\$39	\$36
S-17908	2 x 1½"	2 oz.		42	40	37
S-17909*	2½ x 1¾"	4 oz.		54	50	46
S-23237	2¾ x 2"	6 oz.		68	65	62
S-19909*	3½ x 2"	8 oz.		70	66	62
S-23238	3¾ x 2"	10 oz.		78	74	69
S-17910	3¾ x 2½"	14 oz.		81	77	73
S-23424	4 x 2½"	16 oz.		85	79	74

### SQUARE SOLID LID

MODEL NO.	DIMENSIONS DIAM. x H	CAPACITY	QTY./ CTN.	PRICE PER CARTON		
				1	2	4+
S-20651	2 x 2 x 1"	2 oz.	48	\$43	\$41	\$39
S-20652	2½ x 2½ x 1½"	4 oz.		54	50	46
S-20653	3 x 3 x 2"	8 oz.		63	59	56
S-23231	3½ x 3½ x 2½"	12 oz.		74	70	67
S-23232	4 x 4 x 2½"	16 oz.		88	84	79

### SQUARE WINDOW LID

MODEL NO.	DIMENSIONS DIAM. x H	CAPACITY	QTY./ CTN.	PRICE PER CARTON		
				1	2	4+
S-20654	2 x 2 x 1"	2 oz.	48	\$53	\$50	\$47
S-20655	2½ x 2½ x 1½"	4 oz.		65	62	58
S-20656	3 x 3 x 2"	8 oz.		77	73	68
S-23233	3½ x 3½ x 2½"	12 oz.		85	80	76
S-23234	4 x 4 x 2½"	16 oz.		100	95	90



## DECORATIVE TINS

Give the gift of gourmet treats and snacks.

- Tin-plated steel.
- Snug-fitting lid.
- FDA compliant.

**2 Gallon** – Perfect size for specialty popcorn.

SPECIFY COLOR: Silver, Gold, Red, White or Black

MODEL NO.	DIMENSIONS DIAM. x H	CAPACITY	QTY./ CTN.	PRICE PER CARTON		
				1	3	5+
S-19141	6 x 2"	1 lb.	24	\$100	\$95	\$90
S-19142	7 x 3"	2 lbs.		115	110	105
S-19143	8 x 3"	3 lbs.		100	95	90
S-22941	10 x 3½"	5 lbs.	12	105	100	95
S-22942*	10¼ x 7½"	2 gal.		131	126	121

\*Not available in Black

## SCREW-TOP METAL TINS



Containers for lip balm, lotion and cosmetics.

- Solid screw-top lid closes securely.
- Tin plate. Seamless construction.
- FDA compliant.

### SHALLOW

SPECIFY COLOR: Silver, Gold or Black

MODEL NO.	DIMENSIONS DIAM. x H	CAPACITY	QTY./ CTN.	PRICE PER CARTON		
				1	2	4+
S-23417	1½ x 5/8"	1/2 oz.	48	\$29	\$27	\$25
S-23418	1¾ x 5/8"	1 oz.		32	29	27
S-23419	2½ x 7/8"	2 oz.		33	30	28

### DEEP

SPECIFY COLOR: Silver, Gold or Black

MODEL NO.	DIMENSIONS DIAM. x H	CAPACITY	QTY./ CTN.	PRICE PER CARTON		
				1	2	4+
S-23420	2½ x 1¾"	4 oz.	48	\$48	\$45	\$42
S-23421	3½ x 2"	8 oz.		61	58	55
S-23422*	3¾ x 2½"	14 oz.		73	69	65

\*Available in Silver only

# GABLE BOXES

## CHIPBOARD

FDA COMPLIANT

MODEL NO.	USABLE DIM. L x W x H	COLOR	QTY./CASE	PRICE PER CASE		
				1	5	10+
S-10567	4 x 2½ x 2½"	White	100	\$46	\$44	\$43
S-13182	6 x 4 x 4"			67	64	62
S-8568	8 x 4¾ x 5¼"			71	68	65
S-9616	9 x 6 x 6"			86	84	81
S-12535	10 x 7 x 8"			132	126	120
S-10568	4 x 2½ x 2½"	Kraft	100	44	41	40
S-13183	6 x 4 x 4"			65	62	60
S-8567	8 x 4¾ x 5¼"			69	66	63
S-9615	9 x 6 x 6"			79	74	70
S-12536	10 x 7 x 8"			122	117	111
S-10569	4 x 2½ x 2½"	Black, Red, Green or Blue	100	51	49	47
S-13184	6 x 4 x 4"			71	68	66
S-9798	8 x 4¾ x 5¼"			79	74	70
S-9799	9 x 6 x 6"			107	104	101
S-12537	10 x 7 x 8"			137	131	125



Convenient carry-handle boxes.

- Quick and easy assembly. Fold for easy storage.

S-15409 – Crystal-clear plastic shows off product.

## CLEAR PLASTIC

MODEL NO.	USABLE DIM. L x W x H	COLOR	QTY./CASE	PRICE PER CASE		
				1	5	10+
S-15409	4 x 3 x 2½"	Clear	144	\$78	\$75	\$69

# PILLOW BOXES

Quick packaging for gift certificates or smaller purchases.

- Easy to assemble. • No tape needed.
- Full overlapping flaps for added strength.

Plastic – Crystal-clear boxes show off merchandise.

Chipboard – Gloss finish boxes have light matte interior.



## CLEAR PLASTIC

MODEL NO.	DIMENSIONS L x W x H	COLOR	QTY./CASE	PRICE PER CASE		
				1	5	10+
S-16771	3½ x 3 x 1"	Clear	200	\$64	\$62	\$60
S-12538	4½ x 3½ x 3¼"			\$59 per case any qty.		
S-16772	4½ x 4½ x 1½"			79	77	75
S-13348	7 x 5½ x 2"			91	89	87
S-12539	8 x 4½ x 1⅞"			\$69 per case any qty.		
S-13349	8½ x 5 x 2"			95	93	91
S-16773	12 x 4¾ x 1¼"			123	121	119

## CHIPBOARD

MODEL NO.	DIMENSIONS L x W x H	COLOR	QTY./CASE	PRICE PER CASE		
				1	5	10+
S-13402	3½ x 3 x 1"	White or Kraft	250	\$36	\$35	\$34
S-12540	4½ x 4½ x 1½"			46	44	42
S-11518	7 x 5½ x 2"			69	67	65
S-9806	8½ x 5 x 2"			61	59	57
S-12541	12 x 4¾ x 1¼"			100	40	38
S-23000	3½ x 3 x 1"	Lime, Black, Red or Silver	250	36	35	34
S-23001	4½ x 4½ x 1½"			46	44	42
S-13403	7 x 5½ x 2"			69	67	65

# GLAMOUR BOXES New

Stunning, high gloss gift packaging for cosmetics and fashion accessories.

MODEL NO.	USABLE DIM. L x W x H	COLOR	QTY./BNDL.	SOLD IN BUNDLE QUANTITIES		
				PRICE EACH		
				25	100	500+
S-25100	6 x 6 x 3"	Black, White, Pink or Lime	25	\$2.55	\$2.40	\$2.25
S-25101	8 x 8 x 3"			3.05	2.90	2.75
S-25102	9 x 6½ x 2¾"			3.05	2.90	2.75
S-25103	9 x 6½ x 4"			3.30	3.15	3.05

- Ships flat. Easy assembly.
- High gloss exterior, white interior.
- Sturdy corrugated E flute construction.



# STRETCH LOOPS

Attractive and easy way to secure gift boxes.

50-yard Spool



- Looped cord includes convenient pre-tied bow.

SPECIFY COLOR: Silver Gold Black White Red

MODEL NO.	LOOP SIZE	BOX USE	QTY./ CTN.	PRICE PER CARTON		
				1	2	4+
S-13161*	6"	Earring Box	1,000	\$54	\$50	\$45
S-11630	8"	Jewelry Box		56	51	46
S-9604	10"	Necklace, Gift Box		61	56	52
S-9605	16"	Watch, Card Box		75	70	66
S-9606	22"	Small Apparel, Shirt Box		90	82	77
S-12355*	50-yard Spool			\$15 ea.	\$14 ea.	\$13 ea.

\* Available in Silver, Gold and Black only

# RAFFIA

Spice up your packages, crafts and floral arrangements with this colorful raffia.

Jumbo Roll



- Easy to use and tie.
- 100% Rayon.

\* SPECIFY COLOR: Black White Red Burgundy Blue Hunter Kraft Oatmeal

MODEL NO.	ROLL SIZE W x L	COLOR	PRICE PER ROLL		
			1-2	6	12+
S-9610*	1/4" x 100 yds.	Specify Color	\$8	\$7	\$6
S-15408	1/4" x 2,200 yds.	Red, Hunter, Kraft or Oatmeal	110	105	100

\* Minimum 2 rolls per color



# GROSGRAIN RIBBON

Quality ribbon with the look and feel of fine fabric.

- Finely woven satin texture.
- Create colorful accents.

SPECIFY COLOR: Black White Red Bt. Pink Navy Lt. Blue Green Gray Cream Choc.



MODEL NO.	ROLL SIZE W x L	PRICE PER ROLL		
		1	3	5+
S-11631	7/8" x 100 yds.	\$28	\$27	\$26

# ORGANZA RIBBON

Beautiful sheer ribbon adds a delicately elegant touch.

- Bound edges for crisp, straight lines.
- Wired ribbon, see [uline.com](http://uline.com)

SPECIFY COLOR: Black White Red Burgundy Lt. Pink Blue Hunter Purple Silver Gold



MODEL NO.	ROLL SIZE W x L	PRICE PER ROLL		
		1	3	5+
S-13171	1 1/2" x 100 yds.	\$16	\$15	\$14

# KLEVER KONCEPT™ SAFETY CUTTERS

Reduce employee injuries and damage to merchandise.

- Dual hook design with thick, recessed carbon steel blade.
- Curved, ergonomic handle is easy to hold.
- Lasts twice as long as single blade cutters.

SPECIFY COLOR: Orange, Yellow, Blue or Red



MODEL NO.	QTY./ BAG	PRICE PER CUTTER (MULTIPLES OF 10)			
		10	30	60	120+
H-2723	10	\$2.80	\$2.70	\$2.60	\$2.50

# PULL BOWS

A perfect bow every time!

- Attractive, textured satin finish.
- Tie onto package or basket.



1. Pull String 2. Bow Appears

SPECIFY COLOR: Black White Red Pink Blue Hunter Purple Yellow Silver Gold

MODEL NO.	SIZE	QTY./ CTN.	PRICE PER CARTON	
			1	3+
S-10607	5 1/2" x 20 Loops	50	\$42	\$40
S-13162	8" x 20 Loops		59	55



# VELVET POUCHES

Soft quality velveteen lends a perfect finishing touch to wedding favors, product promos, gifts and more!

- Double cord drawstring pulls tight for a snug, sure closure.
- Unlined, non-scratching interior. • S-11625 – Gusseted.



MODEL NO.	SIZE W x L x D	USABLE DIMENSIONS	QTY./BNDL.	PRICE PER BUNDLE		
				1	5	10+
S-10646	2 x 2½"	1¼ x 2"		\$18	\$17	\$16
S-9673	3 x 4"	2¾ x 3½"		21	20	19
S-9830	4 x 5½"	3¾ x 5"	100	26	25	24
S-12427	5 x 7"	4¾ x 6½"		43	41	39
S-25097	6 x 10"	5¼ x 9½"		54	52	50
S-11625*	8 x 8 x 5"	7½ x 7½ x 4¾"	12	18	17	16

\*Available in Black, Blue and Red only

# ORGANZA BAGS

MODEL NO.	SIZE W x L	USABLE DIMENSIONS	QTY./BNDL.	PRICE PER BUNDLE		
				1	5	10+
S-10647	3 x 4"	2¾ x 2¾"		\$22	\$20	\$18
S-10648	4 x 6"	3¾ x 4¾"		31	28	26
S-11626	5 x 7"	4¾ x 5¼"		37	33	31
S-10649	6 x 10"	5¼ x 7¾"	100	43	40	36
S-12429	6½ x 15"	6¼ x 11½"		79	74	67
S-13169	10 x 12"	9¾ x 9½"		72	66	60
S-13170	12 x 14"	11¾ x 11½"		98	89	81
S-12430	22½ x 25"	22 x 21¾"	10	25	23	21



SPECIFY COLOR:



Attractive presentation for gifts and event favors.

- Recommended for jewelry, cosmetics, candles and gift items.
- Satin ribbon ties to close bag securely.

# SATIN BAGS



Soft and silky. Elegant choice for product giveaways.

- Package perfume and cosmetic samples.
- Satin ribbon drawstring.

SPECIFY COLOR: Black, White, Hot Pink, Silver or Red

MODEL NO.	SIZE W x L	USABLE DIMENSIONS	QTY./BNDL.	PRICE PER BUNDLE		
				1	5	10+
S-21651	3 x 4"	2¾ x 2¾"		\$24	\$22	\$20
S-21653	5 x 7"	4¾ x 5¼"	100	39	35	33
S-24041	6 x 10"	5¼ x 7¾"		60	55	50

# METALLIC POUCHES



Posh bags for upscale salons, jewelry and department stores.

- Glamorous metallic fabric.
- Satin cord drawstring.

SPECIFY COLOR: Gold or Silver

MODEL NO.	SIZE W x L	USABLE DIMENSIONS	QTY./BNDL.	PRICE PER BUNDLE		
				1	5	10+
S-14203	3 x 4"	2¾ x 2¾"		\$39	\$37	\$35
S-14204	5 x 7"	4¾ x 5¼"	120	55	52	48
S-14205	6 x 10"	5¼ x 7¾"		73	69	65

## GIFT WRAP



Dress up any package with our shiny, elegant gift wrap.

- Sturdy wrap won't easily tear or crease.

\* SPECIFY COLOR: Red, Navy or Green

MODEL NO.	ROLL SIZE W x L	DESCRIPTION	COLOR	BASIS WT.	PRICE PER ROLL		
					1	2	4+
S-12352*	24" x 100'	Dispenser Box 	Specify	50 lb.	\$31	\$30	\$29
S-12351			White Gloss	50 lb.	30	29	28
S-12353			Silver Foil	53 lb.	44	43	41
S-12354			Gold Foil	53 lb.	54	51	49
S-8552*	24" x 417'	Jumbo Roll	Specify	50 lb.	105	103	99
S-8551			White Gloss	50 lb.	83	81	78
S-8553			Silver Foil	53 lb.	142	140	138
S-8579			Gold Foil	53 lb.	162	155	149



## TISSUE PAPER PRINTS

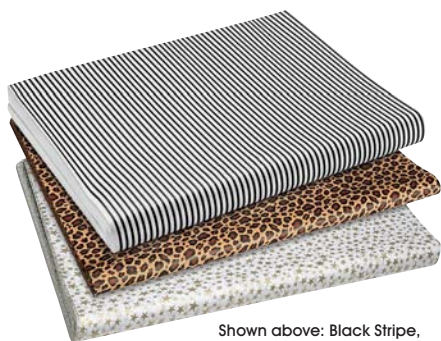

Shown above: Black Stripe, Leopard and Gold Stars

MODEL NO.	SHEET SIZE	DESCRIPTION	SHEETS/ BNDL.	BASIS WT.	PRICE/BUNDLE	
					1	3+
S-23441	20 x 30"	Black Stripe	240	10 lb.	\$52	\$50
S-11651		Gold Stars				
S-14189		Speckled White				
S-14188		Black Toile				
S-11648		Paw Prints				
S-20666		West Indies				
S-24515		White Dots				
S-11652	20 x 30"	Leopard	200	10 lb.	57	55
S-20668		Elegance				
S-14190		Gold Stripe				

ONE COLOR

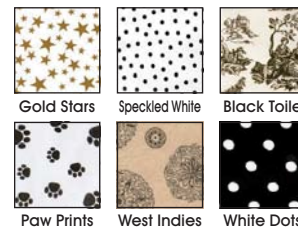

MULTI-COLOR



## SATIN RIBBON



Double faced silky, shiny surface.

- Add a splash of elegance to any gift box or favor.

SPECIFY COLOR: Black, White, Red, Pink, Royal, Lime, Silver or Brown

MODEL NO.	ROLL SIZE W x L	PRICE PER ROLL	
		1	3+
S-19580	1½" x 50 yds.	\$23	\$20

## CANDLE TINS

Make your own candles.

- Snug-fitting, slip-on lids.
- Footed bottom keeps surfaces cool.
- Tin-plated steel. Seamless construction.



MODEL NO.	SIZE DIAMETER x H	CAPACITY	QTY./ CTN.	PRICE PER CARTON		
				1	2	4+
S-23466	2¾" x 1¼"	4 oz.	36	\$60	\$55	\$50
S-23467	3¾" x 2"	8 oz.		85	80	75

## CLEAR VINYL BOXES

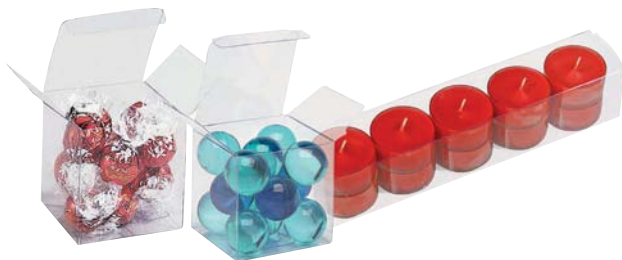

Flexible, durable vinyl folds easily for quick packaging.

- Ships flat to save on space and shipping costs.
- FDA compliant for indirect food contact.

MODEL NO.	SIZE L x W x H	RECOMMENDED USE	QTY./ CTN.	PRICE PER CARTON		
				1	2	4+
S-10651	1½ x 1½ x 8"	Candles, Golf Balls	200	\$90	\$79	\$72
S-9728	2 x 2 x 2"	Truffle, Ornament		76	67	61
S-9729	3 x 3 x 3"	Candle, Favors		91	80	72
S-20670	4 x 4 x 2"	Novelties		110	100	89
S-9730	4 x 4 x 4"	Cup		128	118	109
S-9731	4 x 4 x 6"	Mug, Lotions		146	136	127
S-13353	4 x 4 x 8"	Cups		100	92	81
S-12545	5 x 5 x 5"	Bowl	200	160	149	140
S-10650	5½ x 3¾ x 2"	Cards, Corsage	200	108	95	85
S-12546	6 x 6 x 6"	Tumblers	100	121	109	100
S-12547	12 x 12 x 12"	Cocktail Set	50	217	207	198

# TISSUE PAPER

Add distinction to your packaging with superior quality, colored tissue.

- White and Kraft Tissue – Nontarnishing. Keeps fine jewelry and silverware from tarnishing.
- Choose from 26 colors, including Metallic Gold and Silver.

## WHITE

MODEL NO.	COLOR	SHEET SIZE	BASIS WT.	SHEETS/ BNDL.	PRICE PER BUNDLE	
					1	3+
S-13175	White	10 x 15"	10 lb.	960	\$21	\$20
S-15430		12 x 18"		960	25	23
S-12345		15 x 20"		960	27	25
S-14197		18 x 24"		960	31	29
S-7097W		20 x 30"		480	25	23
S-11572		24 x 36"		960	67	62
■ S-2227	White – Bulk	20 x 30"	10 lb.	4,800	185	175

■ SHIPS VIA MOTOR FREIGHT

## KRAFT

MODEL NO.	COLOR	SHEET SIZE	BASIS WT.	SHEETS/ BNDL.	PRICE PER BUNDLE	
					1	3+
S-13178	Kraft	15 x 20"	10 lb.	960	\$25	\$23
S-7097K		20 x 30"		480		

## COLORS

MODEL NO.	COLOR	SHEET SIZE	BASIS WT.	SHEETS/ BNDL.	PRICE PER BUNDLE	
					1	3+
S-13177	Red, Black, Citrus, Gray, Light Pink, Bright Pink, Purple or Royal Blue	15 x 20"	10 lb.	960	\$40	\$39
S-7097*	Specify Color	20 x 30"	10 lb.	480	36	35

## METALLICS

MODEL NO.	COLOR	SHEET SIZE	BASIS WT.	SHEETS/ BNDL.	PRICE PER BUNDLE	
					1	3+
S-22253	Silver or Gold	15 x 20"	11 lb.	400	\$62	\$60
S-9831		20 x 30"		200	58	56



* SPECIFY COLOR	BLACK	GRAY	RED	DARK GREEN	MIDNIGHT BLUE
CHOCOLATE	ORANGE	BURGUNDY	BERRY	KELLY GREEN	ROYAL BLUE
KRAFT	YELLOW	PURPLE	BRIGHT PINK	CITRUS	TURQUOISE
KHAKI	FRENCH VANILLA	LAVENDER	LIGHT PINK	TEAL	LIGHT BLUE
METALLIC COLORS:				SILVER	GOLD

# TISSUE PAPER ROLLS

Convenient size for easy dispensing all season long.

- Custom length every time.
- For packaging and crafts.

MODEL NO.	COLOR	ROLL SIZE W x L	BASIS WT.	LBS./ ROLL	PRICE PER ROLL	
					1	3+
S-7263	White or Kraft Black	20" x 5,200'	10 lb.	32	\$104	\$99
S-22874					205	194



# TISSUE PAPER ASSORTMENTS

Create beautiful packages all year long.

- Black and White – Includes 3 different prints.
- Solids assortment – Includes 14 colors including white.

MODEL NO.	DESCRIPTION	SHEET SIZE	BASIS WT.	SHEETS/ BNDL.	PRICE PER BUNDLE	
					1	3+
S-21191	Black and White	20 x 30"	10 lb.	240	\$53	\$51
S-6072	Solids			480	49	47

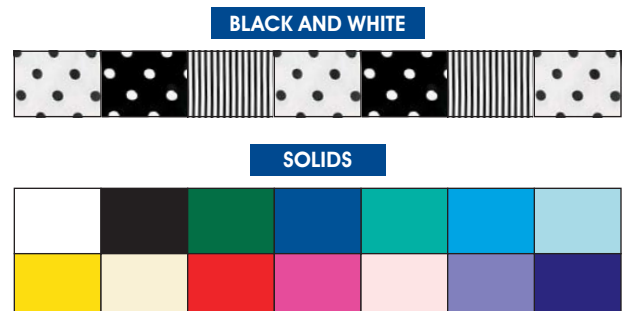



# MAGNETIC GIFT BOXES

ONE PIECE



HIGH GLOSS



MATTE FINISH

SHIPS FLAT – EASY TO ASSEMBLE



Boxes so nice they'll outlast the gift. Perfect for storing expensive items.

- Sturdy chipboard with strong magnetic closure.

High Gloss – Extra glossy shine showcases luxury items.

Matte – Handsome look for a "wow" factor.

SPECIFY COLOR: Black, White or Red

SIZE L x W x H	QTY./ CTN.	LBS./ CTN.	MODEL NO.	HIGH GLOSS			MATTE*			
				PRICE PER CARTON	MODEL NO.	PRICE PER CARTON	1	5	10+	
3½ x 3½ x 1½"	10	2	S-25108	\$55	\$50	\$45	S-25111	\$65	\$60	\$55
6 x 6 x 2¾"		4	S-24094	75	70	65	S-24510	90	85	80
8 x 8 x 3⅝"		7	S-24095	85	80	75	S-24511	105	100	95
10 x 10 x 4½"		13	S-24096	95	90	85	S-24512	120	115	110
12 x 12 x 4½"		22	S-25109	120	115	110	S-25112	145	140	135
13 x 10¾ x 5½"		19	S-24576	135	130	125	S-25113	160	155	150
16 x 12 x 8"	5	15	S-25110	115	110	105	S-25114	140	135	130

\*Also available in Navy

## JUMBO SHOPPER

HIGH GLOSS



Huge, reusable bags for toting bulky bedding, pillows and home goods.

- Laminated polypropylene.
- Wide, gusseted bottom. 28" long handles.

MODEL NO.	SIZE W x D x H	QTY./ CTN.	PRICE PER CARTON			LBS./ CTN.
			1	5	10+	
S-24540	21 x 13 x 14"	50	\$195	\$183	\$170	17

## JUMBO GIFT BAGS

New

Extra large, reusable gift bags for hard-to-wrap gifts.

- Recommended for toys, stuffed animals and bulky items.
- 100% polyester fabric.
- Satin drawstring.



SPECIFY COLOR: Gold, Silver, Red Plaid or White Plaid

MODEL NO.	SIZE W x L	USABLE DIMENSIONS	QTY./ BNDL.	PRICE PER BUNDLE		
				1	5	10+
S-25115	9½ x 12½"	9¼ x 10¼"	10	\$26	\$24	\$22
S-25116	12 x 16"	11½ x 12"		34	32	30
S-25117	16½ x 22"	16¼ x 16½"		52	49	46

## WOOD GIFT BOXES

New

Rustic packaging. Recommended for your wines, gourmet foods and luxury gifts.



- Natural pine wood with plywood top and bottom. Unfinished.
- Easily slide lid open and closed.
- FDA compliant for indirect food contact.



MODEL NO.	SIZE L x W x H	QTY./ CTN.	PRICE PER CARTON			LBS./ CTN.
			1	5	10+	
S-25118	6¾ x 4¾ x 3"	6	\$35	\$33	\$30	5
S-25119	8 x 8 x 3⅝"		45	43	40	7
S-25120	10 x 10 x 5"		85	83	80	10
S-25121	14 x 4 x 4"		65	63	60	12

# CRINKLE PAPER

Attractive void fill for baskets and gift boxes.

- Firmly nestle product in place with interlocking crinkle-cut paper.
- Convenient 10 lb. carton is UPSable.
- **Paper and Metallic Blends** – Add an extra festive touch.
- \* 40 lb. carton available in Red, French Vanilla, Forest Green, Black, Lime, Kraft, White, Ivory and Navy Blue.



S-15484

Gift Boxes, pages 172-179.

MODEL NO.	DESCRIPTION	LBS./ CTN.	PRICE PER CARTON		
			1	5	10+
S-6118	Kraft	10	\$40	\$38	\$36
S-7645	White		47	45	42
S-6119	Specify Color		<b>\$54 per carton any qty.</b>		
S-15484	Red/Green Blend	10	59	56	54
S-9834▲	Specify Metallic Blend		98	92	89
S-9713	Kraft	40	126	122	118
S-9712	White		154	150	145
S-11627*	Specify Color		204	200	194



Navy Blue	Forest Green	Red	Burgundy	Chocolate
Royal Blue	Green	Orange	Purple	Kraft
Light Blue	Lime	Pink	Lavender	Cognac
Teal	Olive	Light Pink	Ivory	Yellow
French Vanilla	White	Black	Gray	Iridescent/White▲
Red/Green	Silver/White▲	Gold/White▲	Silver/Black▲	Gold/Red▲

# MARKET TRAYS

Designer packaging for product displays.

- Recommended for salons and boutiques.
- Thick, sturdy paperboard with die-cut handles.
- Nestable. Ships assembled.



Prints, see uline.com SPECIFY COLOR: Kraft, Red, Black, Lime or White

MODEL NO.	SIZE W x L x H	QTY./ PACK	PRICE PER PACK		
			1	5	8+
S-22254	9 x 7 x 3"	6	\$29	\$28	\$27
S-22255	12 x 9 x 4"		38	36	34

# EXCELSIOR

Support heavier items without matting or losing shape.

- Clean, non-allergenic and dust-free.
- Natural hardwood strands.
- 100% biodegradable.
- 8 oz. supports approx. 3 lbs.



MODEL NO.	COLOR	LBS./ CTN.	PRICE PER CARTON		
			1	5	10+
S-12432	Undyed	5	\$22	\$21	\$20
S-12434		25	56	54	52

# CELLO/POLYPROPYLENE ROLLS

1 MIL

MODEL NO.	COLOR	ROLL SIZE	QTY./ CTN.	PRICE PER ROLL		
				1-4	8	16+
S-8575	Clear	24" x 100'	4	\$9	\$8	\$7
S-8576		30" x 100'		10	9	8
S-8577		40" x 100'		12	11	10
S-13245	Clear	30" x 1,500'	1	148	139	130
S-13246		40" x 1,500'		190	180	170

SOLD IN CARTON QUANTITIES

Wrap baskets, gifts or flowers – A beautiful accent to your packaging.

- Keeps moisture and dirt out.
- Cut roll to desired length. Tie to close.
- Colors and sheets, see uline.com



# POLYPROPYLENE BAGS



**FLAT 1.5 MIL**



**FLAT 3 MIL**



**GUSSETED**

Crystal clear, cello-style bags make product sparkle.

- Flat bags – Packaging for pennies apiece.
- Gusseted bags – Sides expand to fit product.
- Resists moisture and grease.
- Archival safe.

## FLAT – 1.5 MIL

FDA AND USDA COMPLIANT

MODEL NO.	DIMENSIONS W x L	HOLDS	PRICE PER CARTON		QTY./ CTN.
			1	3+	
S-8524	2 x 3"	1/2 oz.	\$53	\$47	10,000
S-22823	2 x 8"	3 oz.	120	112	10,000
S-19157	2 x 10"	3 oz.	160	150	10,000
S-10642	3 x 4"	1 1/2 oz.	82	75	10,000
S-22824	3 x 5"	2 oz.	92	85	10,000
S-3371	3 x 5 1/2"	2 oz.	101	93	10,000
S-11584	3 x 8"	4 oz.	69	63	5,000
S-22825	3 x 10"	5 oz.	50	45	2,000
S-16802	3 x 11"	6 oz.	52	47	2,000
S-22826	3 1/2 x 7"	4 oz.	72	66	5,000
S-14199	4 x 4"	3 oz.	55	49	5,000
S-16803	4 x 5"	3 1/2 oz.	65	59	5,000
S-11585	4 x 6"	4 oz.	69	63	5,000
S-16804	4 x 8"	4 1/2 oz.	52	47	2,000
S-19158	4 x 10"	6 oz.	54	48	2,000
S-11586	4 x 12"	1 lb.	55	49	2,000
S-3372	4 1/4 x 6 3/4"	5 oz.	88	81	5,000
S-16805	5 x 5"	4 oz.	84	77	5,000
S-22827	5 x 6"	6 oz.	85	78	5,000
S-14200	5 x 7"	1/2 lb.	86	79	5,000
S-15451	5 x 8"	3/4 lb.	107	99	5,000
S-24508	5 x 10"	1 lb.	50	45	2,000
S-11587	5 x 12"	2 lbs.	63	57	2,000
S-3373	5 1/4 x 7 3/4"	1 lb.	55	49	2,000
S-7077	5 1/4 x 9 3/4"	1 1/2 lbs.	62	56	2,000
S-14201	6 x 6"	3/4 lb.	42	37	2,000
S-12500	6 x 8"	1 lb.	27	24	1,000
S-16806	6 x 9"	1 1/2 lbs.	32	28	1,000
S-14202	6 x 10"	2 lbs.	33	29	1,000
S-13136	6 x 12"	2 lbs.	42	37	1,000
S-22828	6 x 18"	3 lbs.	60	54	1,000
S-22829	7 x 7"	1 lb.	27	24	1,000
S-13137	7 x 10"	2 lbs.	40	35	1,000
S-22830	7 x 12"	2 1/2 lbs.	54	48	1,000
S-8525	8 x 10"	3 lbs.	54	48	1,000
S-15452	8 x 12"	3 lbs.	56	50	1,000
S-19159	8 x 14"	3 lbs.	62	56	1,000
S-3501	9 x 12"	3 lbs.	60	54	1,000
S-22832	9 x 14"	3 lbs.	65	59	1,000
S-19160	10 x 12"	3 lbs.	62	56	1,000

## FLAT – 1.5 MIL

FDA AND USDA COMPLIANT

MODEL NO.	DIMENSIONS W x L	HOLDS	PRICE PER CARTON		QTY./ CTN.
			1	3+	
S-13138	10 x 15"	3 1/2 lbs.	\$70	\$64	1,000
S-22833	10 x 16"	3 1/2 lbs.	76	70	1,000
S-19161	11 x 14"	3 1/2 lbs.	70	64	1,000
S-22834	12 x 16"	3 1/2 lbs.	98	90	1,000
S-11588	12 x 18"	3 1/2 lbs.	104	96	1,000
S-5836	14 x 20"	8 lbs.	138	129	1,000
S-11589	18 x 24"	8 lbs.	201	188	1,000

## FLAT – 3 MIL

FDA AND USDA COMPLIANT

MODEL NO.	DIMENSIONS W x L	HOLDS	PRICE PER CARTON	QTY./ CTN.
S-13139	3 x 5 1/2"	2 oz.	\$23	1,000
S-13140	4 x 6"	4 oz.	26	1,000
S-13141	4 1/4 x 6 3/4"	1/2 lb.	39	1,000
S-13142	5 1/4 x 7 3/4"	1 lb.	50	1,000
S-22836	7 x 10"	2 lbs.	98	1,000
S-19162	8 x 10"	3 lbs.	109	1,000

## GUSSETED – 1.5 MIL

FDA AND USDA COMPLIANT

MODEL NO.	DIMENSIONS W x D x H	HOLDS	PRICE PER CARTON		QTY./ CTN.
			1	3+	
S-3374	2 1/2 x 3/4 x 6 1/2"	4 oz.	\$28	\$25	2,000
S-5837	2 1/2 x 1 1/4 x 7 1/2"	6 oz.	44	39	2,000
S-13133	3 x 1 1/4 x 8 1/4"	7 oz.	56	50	2,000
S-16797	3 1/2 x 2 x 7 1/2"	8 oz.	59	53	2,000
S-3375	3 1/2 x 2 1/4 x 9 3/4"	1 lb.	61	55	2,000
S-15450	4 x 2 x 6"	8 oz.	54	48	2,000
S-13134	4 x 2 x 8"	1 lb.	57	51	2,000
S-16798	4 x 2 x 9"	1 lb.	64	59	2,000
S-17970	4 x 2 x 10"	2 lbs.	68	63	2,000
S-17971	4 x 2 1/4 x 9"	2 lbs.	66	61	2,000
S-5838	4 1/2 x 2 1/4 x 10 1/4"	3 lbs.	83	76	2,000
S-3376	4 1/2 x 3 1/4 x 13"	3 lbs.	107	99	2,000
S-16799	5 x 2 1/2 x 11"	2 1/2 lbs.	54	48	1,000
S-16800	5 x 3 x 11 1/2"	3 lbs.	56	50	1,000
S-16801	5 x 3 x 15"	3 lbs.	67	63	1,000
S-6625	5 1/4 x 3 x 13"	3 lbs.	59	53	1,000
S-11590	6 x 3 1/4 x 13 1/2"		66	60	1,000
S-12503	6 x 4 x 15"	Corsage	85	78	1,000
S-17972	8 x 3 x 15"		111	103	1,000
S-12504	8 x 4 x 18"		119	111	1,000
S-24509	12 x 4 x 16"	Gift Box	140	130	1,000
S-13135	12 x 8 x 20"		109	101	500



# POLYPROPYLENE BAGS

No heat sealing needed!  
Close and reclose.

- Resealable bags – Peel off strip. Fold to seal with ease.
- Reclosable bags – Lock out dirt and moisture.
- Resist moisture and grease. Archival safe.
- FDA and USDA compliant.



## RESEALABLE – 1.5 MIL

MODEL NO.	USABLE DIM. W x L	RECOMMENDED USE	PRICE PER CARTON		QTY./ CTN.
			1	3+	
S-15454	2 x 3"	Charms	\$26	\$24	1,000
S-14236	3 x 3"	Coins	28	26	1,000
S-17949	3 x 4"	Name Badge	29	27	1,000
S-11574	3 x 5"	Trading Card	30	28	1,000
S-16827	4 x 4"	Pin	30	28	1,000
S-7078	4 x 6"	Photo	32	30	1,000
S-22846	4 x 8"	Pamphlet	39	36	1,000
S-11575	4 1/4 x 9 1/2"	Greeting Card	41	38	1,000
S-16828	4 3/4 x 5 3/4"	Envelope	39	36	1,000
S-13258	4 3/4 x 6 3/4"	Photo	39	36	1,000
S-24516	5 x 6"	Envelope	39	36	1,000
S-12493	5 x 7"	Photo	39	36	1,000
S-17951	5 x 12"	Tri-fold Brochure	46	44	1,000
S-7079	5 1/4 x 8"	Card	41	38	1,000
S-13259	5 1/2 x 7 1/2"	Photo	41	38	1,000
S-7080	6 x 5"	CD	34	32	1,000
S-16829	6 x 6"	CD	38	36	1,000
S-12494	6 x 8"	Greeting Card	43	39	1,000
S-8522	6 x 9"	DVD	47	43	1,000
S-15455	6 x 11"	Postcard	51	47	1,000
S-14237	6 1/4 x 6 1/4"	Card	43	39	1,000
S-17952	6 1/2 x 9 1/2"	Blu-Ray	48	44	1,000
S-11576	7 x 7"	Cookies	43	39	1,000
S-16830	7 x 9"	DVD	51	47	1,000
S-16831	8 x 8"	45 Record	53	49	1,000
S-8523	8 x 10"	Portrait	65	61	1,000
S-15456	8 1/2 x 11"	Literature	70	66	1,000
S-7081	9 x 12"	T-Shirt	76	72	1,000
S-11577	10 x 13"	Artwork	83	79	1,000
S-13260	11 x 14"	Portrait	89	84	1,000
S-9646	12 x 16"	Dress Shirt	100	95	1,000
S-10641	12 x 18"	Calendar	104	99	1,000
S-15457	13 x 13"	Scrapbook Page	100	95	1,000
S-22848	13 x 19"	Art Print	130	125	1,000
S-13261	14 x 20"	Sweater	130	125	1,000
S-12495	16 x 20"	Small Poster	158	148	1,000
S-13262	18 x 24"	Blanket	195	184	1,000

## RECLOSABLE – 2 MIL

MODEL NO.	USABLE DIM. W x L	HOLDS	PRICE PER CARTON		QTY./ CTN.
			1	3+	
S-17954*	2 x 2"	1/4 oz.	\$26	\$24	1,000
S-13263*	2 x 3"	1/2 oz.	28	26	1,000
S-11578*	3 x 3"	1 oz.	30	28	1,000
S-11579*	3 x 4"	1 1/2 oz.	31	29	1,000
S-10643	3 x 5"	2 oz.	33	31	1,000
S-22849	3 x 6"	3 oz.	38	35	1,000
S-12497	4 x 4"	3 oz.	33	31	1,000
S-17956	4 x 5"	3 1/2 oz.	38	35	1,000
S-6621	4 x 6"	4 oz.	41	38	1,000
S-14238	4 x 7"	4 1/2 oz.	49	45	1,000
S-24517	4 x 8"	4 1/2 oz.	53	50	1,000
S-17957	5 x 5"	4 oz.	54	51	1,000
S-22850	5 x 6"	6 oz.	55	52	1,000
S-16832	5 x 7"	1/2 lb.	57	53	1,000
S-11580	5 x 8"	3/4 lb.	58	54	1,000
S-17958	5 x 10"	1 lb.	60	56	1,000
S-11581	6 x 6"	3/4 lb.	64	60	1,000
S-6622	6 x 8"	1 lb.	65	61	1,000
S-11582	6 x 9"	1 1/2 lbs.	76	72	1,000
S-10644	7 x 9"	2 lbs.	79	75	1,000
S-16833	7 x 10"	2 lbs.	81	77	1,000
S-12498	8 x 8"	2 1/2 lbs.	82	78	1,000
S-6623	8 x 10"	3 lbs.	85	81	1,000
S-16834	8 x 12"	3 lbs.	98	93	1,000
S-11583	9 x 12"	3 lbs.	100	95	1,000
S-16835	10 x 10"	3 lbs.	101	96	1,000
S-6624	10 x 12"	3 lbs.	102	97	1,000
S-16836	10 x 13"	3 lbs.	108	103	1,000
S-13264	12 x 12"	3 lbs.	111	106	1,000
S-12499	12 x 15"	3 1/2 lbs.	125	118	1,000

## RECLOSABLE – 4 MIL

MODEL NO.	USABLE DIM. W x L	HOLDS	PRICE PER CARTON		QTY./ CTN.
			1	3+	
S-13265	4 x 6"	4 oz.	\$71	\$67	1,000
S-17960	6 x 8"	1 lb.	87	84	1,000
S-22851	6 x 9"	1 lb.	95	90	1,000
S-13266	12 x 15"	3 1/2 lbs.	127	119	500

# STAND-UP BARRIER POUCHES

MORE SIZES AVAILABLE, SEE [ULINE.COM](http://ULINE.COM)



ULTRA CLEAR



MATTE

MATTE WITH WINDOW

Make your products "POP" off the shelves. Choose between a glossy Ultra Clear or an elegant, smooth Matte finish. Airtight zipper and thick barrier material lock in freshness. • Heat sealable above tear notches. • FDA/USDA compliant.

• SPECIFY ULTRA CLEAR COLOR:



Black

Blue

Lime

▲ SPECIFY MATTE COLOR:



Black

Black Back

White

White Back

Lime

\* SPECIFY MATTE WITH WINDOW COLOR:



Black

White

Silver

Blue

## ULTRA CLEAR FRONT – ULTRA CLEAR BACK

MODEL NO.	COLOR	OUTSIDE DIM. W x H x D	HOLDS	MIL	QTY./ CTN.	PRICE PER CARTON		
						1	3	5+
S-23429	Clear	4 x 6 x 2"	2 oz.	4.0	1,000	\$115	\$110	\$105
S-23430		5 x 8 x 2½"	4 oz.			155	145	135
S-23431		6 x 9 x 3"	8 oz.			210	200	190

## ULTRA CLEAR FRONT – COLORED BACK

MODEL NO.	COLOR	OUTSIDE DIM. W x H x D	HOLDS	MIL	QTY./ CTN.	PRICE PER CARTON		
						1	3	5+
S-23432	Specify*	4 x 6 x 2"	2 oz.	4.0	1,000	\$125	\$120	\$115
S-23433		5 x 8 x 2½"	4 oz.			160	155	145
S-23434		6 x 9 x 3"	8 oz.			212	202	192

## MATTE

MODEL NO.	COLOR	OUTSIDE DIM. W x H x D	HOLDS	MIL	QTY./ CTN.	PRICE PER CARTON		
						1	3	5+
S-24065	Specify▲	3½ x 5½ x 2"	1 oz.	5.0	2,000	\$205	\$195	\$185
S-22820		4 x 6 x 2"	2 oz.			118	113	108
S-22821		5 x 8 x 2½"	4 oz.		154	149	139	
S-22822		6 x 9 x 3"	8 oz.		202	192	182	
S-24663		6 x 11 x 3"	12 oz.		241	231	216	
S-23415		7 x 11½ x 4"	16 oz.		149	139	128	
S-24066		9 x 13½ x 4¾"	32 oz.					221

## MATTE WITH WINDOW

MODEL NO.	COLOR	OUTSIDE DIM. W x H x D	HOLDS	MIL	QTY./ CTN.	PRICE PER CARTON		
						1	3	5+
S-25069	Specify*	4 x 6 x 2"	2 oz.	5.0	1,000	\$140	\$135	\$130
S-25070		5 x 8 x 2½"	4 oz.			175	170	160
S-25071		6 x 9 x 3"	8 oz.			225	215	205
S-25072		7 x 11½ x 4"	16 oz.		170	160	150	
S-25073		9 x 13½ x 4¾"	32 oz.					235

# STAND-UP COFFEE POUCHES

Lock in the flavor and aroma of your freshly roasted coffee beans.

- Reclosable, airtight zipper seals in freshness.
- Heat sealable above tear notches.

FDA AND USDA COMPLIANT

SPECIFY COLOR: Glossy Black or Kraft

MODEL NO.	OUTSIDE DIM. W x H x D	HOLDS	MIL	QTY./ CTN.	PRICE PER CARTON		
					1	3	5+
S-23456	6 x 9 x 3"	8 oz.	6.0	500	\$175	\$165	\$160
S-23457	7 x 11½ x 4"	16 oz.			210	200	190

- One-way valve allows gases to escape, extending shelf life.
- Use with Custom Printed Labels, see [uline.com](http://uline.com)



# STAND-UP BARRIER POUCHES



## CLEAR

MODEL NO.	COLOR	OUTSIDE DIM. W x H x D	HOLDS	MIL	QTY./CTN.	PRICE PER CARTON		
						1	3	5+
S-22240	Clear	3 7/8 x 5 7/8 x 2"	1 oz.	5.0	2,000	\$195	\$185	\$175
S-19171		4 x 6 x 2"	2 oz.		1,000	108	103	98
S-22816		4 1/2 x 7 x 2 3/8"	3 oz.			128	123	118
S-19172		5 x 8 x 2 1/2"	4 oz.			149	139	128
S-19173		6 x 9 x 3"	8 oz.			200	190	180
S-19174		6 x 11 x 3"	12 oz.			226	216	200
S-20712		7 x 11 1/2 x 4"	16 oz.		500	139	128	123
S-21654		9 x 13 1/2 x 4 3/4"	32 oz.			205	190	185
S-22817		11 1/4 x 15 3/4 x 5 3/8"	64 oz.			300	175	164

Airtight zippered display pouches lock in freshness.

- Thick barrier material protects items from moisture, gas and odor.
- Heat sealable above tear notches.
- FDA and USDA compliant.

## KRAFT

\* SPECIFY COLOR: Kraft or Kraft Back

MODEL NO.	COLOR	OUTSIDE DIM. W x H x D	HOLDS	MIL	QTY./CTN.	PRICE PER CARTON		
						1	3	5+
S-21232	Specify*	4 x 6 x 2"	2 oz.	6.0	1,000	\$128	\$123	\$118
S-21233		5 x 8 x 2 1/2"	4 oz.			195	185	175
S-21234		6 x 9 x 3"	8 oz.			257	247	231
S-21235		6 x 11 x 3"	12 oz.		272	262	247	
S-21236		7 x 11 1/2 x 4"	16 oz.		500	185	175	164
S-22837		9 x 13 1/2 x 4 3/4"	32 oz.			262	252	236



## COLORS – GLOSSY

MODEL NO.	COLOR	OUTSIDE DIM. W x H x D	HOLDS	MIL	QTY./CTN.	PRICE PER CARTON		
						1	3	5+
S-22818	Specify*	3 7/8 x 5 7/8 x 2"	1 oz.	5.0	2,000	\$205	\$195	\$185
S-19167		4 x 6 x 2"	2 oz.		1,000	118	113	108
S-19168		5 x 8 x 2 1/2"	4 oz.			154	149	139
S-19169		6 x 9 x 3"	8 oz.			202	192	182
S-19170		6 x 11 x 3"	12 oz.			241	231	216
S-20713		7 x 11 1/2 x 4"	16 oz.			500	149	139
S-22819		9 x 13 1/2 x 4 3/4"	32 oz.		221		205	195

## \* COLORS – GLOSSY



## KRAFT WITH WINDOW

MODEL NO.	COLOR	OUTSIDE DIM. W x H x D	HOLDS	MIL	QTY./CTN.	PRICE PER CARTON		
						1	3	5+
S-22246	Kraft w/ Window	4 x 6 x 2"	2 oz.	6.0	1,000	\$144	\$139	\$134
S-22247		5 x 8 x 2 1/2"	4 oz.			211	200	190
S-22248		6 x 9 x 3"	8 oz.			272	262	247
S-22249		6 x 11 x 3"	12 oz.		283	272	257	
S-22250		7 x 11 1/2 x 4"	16 oz.		500	195	185	175



## COLORS WITH WINDOW – GLOSSY

MODEL NO.	COLOR	OUTSIDE DIM. W x H x D	HOLDS	MIL	QTY./CTN.	PRICE PER CARTON		
						1	3	5+
S-22241	Specify▲	4 x 6 x 2"	2 oz.	5.0	1,000	\$139	\$134	\$128
S-22242		5 x 8 x 2 1/2"	4 oz.			175	170	159
S-22243		6 x 9 x 3"	8 oz.			221	211	200
S-22244		6 x 11 x 3"	12 oz.		262	252	236	
S-22245		7 x 11 1/2 x 4"	16 oz.		500	164	159	149

## ▲ COLORS W/ WINDOW – GLOSSY

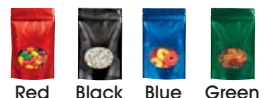



# CRYSTAL CLEAR BAGS



Clearest poly bags Uline sells.

- Protect and show off your finest prints and photography.
- 100% blemish-free virgin polypropylene.
- Acid-free, archival safe.

## RESEALABLE – 1.2 MIL

FDA COMPLIANT

MODEL NO.	USABLE DIM. W x L	RECOMMENDED USE	PRICE PER CARTON		QTY./CTN.	
			1	3+		
S-15459	3 x 5"	Trading Card	\$39	\$33	1,000	
S-17912	4 1/8 x 9 1/2"	Greeting Card	59	54		
S-17911	4 1/4 x 6 1/2"	Photo	54	49		
S-17913	5 1/4 x 7 1/4"	Photo	58	52		
S-15460	6 x 9"	DVD	62	56		
S-16837	7 x 10"	Artwork	79	74		
S-19107	8 x 10"	Portrait	83	79		
S-15461	9 x 12"	T-Shirt	90	85		
S-16838	10 x 13"	Artwork	107	102		
S-19108	11 x 14"	Small Poster	118	112		
S-16839	12 x 16"	Dress Shirt	139	132		
S-22938	12 x 18"	Calendar	182	169		
S-22939	16 1/2 x 20"	Small Poster	242	230		
S-17915*	25 x 37"	Poster	185	175		250

\*1.6 MIL

# STAND-UP BAGS



Showcase your product in these bottom-gusseted bags.

- Chipboard-reinforced bottom.
- Resist moisture.
- High-clarity polypropylene.
- Gold Stripe Bags, see uline.com

## 1.4 MIL

FDA AND USDA COMPLIANT

MODEL NO.	DIMENSIONS W x D x H	HOLDS	PRICE PER PACK		QTY./PACK
			1	10+	
S-16902	1 1/4 x 1 3/4 x 7"	3 oz.	\$32	\$29	100
S-12560	1 3/4 x 1 3/4 x 8 1/2"	1/4 lb.	34	32	
S-16903	2 5/8 x 1 1/4 x 10 1/2"	3/4 lb.	41	39	
S-12561	3 1/4 x 2 x 12"	1 lb.	44	41	
S-12562	4 x 2 1/2 x 13"	3 lbs.	56	53	
S-20803	5 x 3 1/4 x 13"	4 lbs.	77	72	

# CELLOPHANE BAGS



Keep your chocolate chip cookies fresh.

- Moisture resistant; preserve freshness.
- Heat sealable. Clear.
- FDA compliant.

## 1.2 MIL

MODEL NO.	DIMENSIONS W x L	STYLE	HOLDS	PRICE PER CARTON		QTY./CTN.
				1	3+	
S-16897	3 x 5 1/2"	Flat	2 oz.	\$81	\$74	1,000
S-16898	4 3/4 x 6 3/4"		5 oz.	106	100	
S-23601	5 3/4 x 7 3/4"		1 lb.	130	122	
S-16899	2 1/2 x 1 1/4 x 7 1/2"	Gusseted	6 oz.	100	92	1,000
S-16900	3 1/2 x 2 1/4 x 9 3/4"		1 lb.	180	162	
S-16901*	4 x 2 3/4 x 10 3/4"		2 1/2 lbs.	229	218	

\*1.65 MIL



# HAND SEALER

A crimped seal for polypropylene and foil bags. • Foot pedal and clamps included.

- On/off safety switch with temperature control.
- For bags 6" or wider, use Impulse Sealers, pages 153-155.

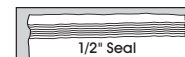

MODEL NO.	DESCRIPTION	SEAL SIZE L x W	WATTS	MAX. SEAL THICKNESS	PRICE EACH	
					1	2+
H-1069	Crimper	6 x 1/2"	50	10 mil	\$170	\$165



# FLAT BARRIER POUCHES

Convenient hanging pouches for jerky, trail mix and candy.

- Moisture and oxygen resistant. Preserve flavor and freshness.
- Heat sealable above tear notches with airtight, reclosable zipper.
- FDA and USDA compliant.

## COLORED BACK

SPECIFY COLOR: Silver Back or Black Back

MODEL NO.	OUTSIDE DIM. W x H	HOLDS	MIL	QTY./CTN.	PRICE PER CARTON		
					1	3	5+
S-22838	4 x 6"	1 oz.	5.0	1,000	\$108	\$103	\$98
S-22839	5 x 7"	2 oz.			139	134	128
S-22840	6 x 9"	4 oz.			190	180	170

## CLEAR

S-22841	4 x 6"	1 oz.	5.0	1,000	\$98	\$92	\$87
S-22842	5 x 7"	2 oz.			134	128	123
S-22843	6 x 9"	4 oz.			185	175	164

# FOOD BAGS

Preserve foods, dry mixes and other materials.

- Metalized poly provides two layers of protection from moisture and light.
- FDA and USDA compliant.

**Reclosable** – Zipper-top closure and bottom seal. Reusable.

**Open End** – Use with Hand Sealer, see page 190.



## RECLOSABLE

MODEL NO.	USABLE DIMENSIONS	MIL	QTY./ CTN.	PRICE PER CARTON		
				1	3	5+
S-20711	2 x 3"	2.5	1,000	\$103	\$99	\$94
S-16893	3 x 5"			120	116	111
S-18132	3½ x 4"			110	106	102
S-16894	4 x 6"			139	135	129
S-21993	5 x 7"			150	145	140
S-16895	6 x 8"			178	173	168
S-18133	6 x 10"			192	187	181
S-16896	8 x 10"			232	226	219
S-21994	10 x 12"			2.5	500	174
S-24087	10 x 16"	189	184			179
S-18134	12 x 18"	238	231			223
S-22298	18 x 24"	2.5	100	117	113	109
S-23408	20 x 29"	4.4		245	240	235

## OPEN END

MODEL NO.	USABLE DIMENSIONS	MIL	QTY./ CTN.	PRICE PER CARTON				
				1	3	5+		
S-18136	2 x 3"	2.5	1,000	\$73	\$70	\$66		
S-11660	3 x 5"			86	82	77		
S-18137	3½ x 4"			83	79	74		
S-11661	4 x 6"			100	96	90		
S-16891	5 x 7"			106	101	95		
S-6175	6 x 8"			110	106	100		
S-6176	6 x 10"			143	137	132		
S-6177	8 x 10"			166	160	153		
S-22299	8 x 12"			203	197	191		
S-16892	10 x 12"			226	219	211		
S-22300	10 x 14"			2.5	500	140	135	130
S-6180	12 x 18"					201	194	186
S-18138	18 x 24"			2.5	100	93	88	83
S-18139	20 x 30"			4.4		172	165	157

# SQUARE BOTTOM BAGS

Easy to fill. Scoop your treats into these square bottom bags.

- Thick barrier material and reclosable zipper lock in freshness.

SPECIFY COLOR: Clear, Glossy Black or Kraft

MODEL NO.	OUTSIDE DIM. W x H x D	HOLDS	MIL	QTY./ CTN.	PRICE PER CARTON		
					1	3	5+
S-24577	5 x 8 x 3"	8 oz.	5.0	500	\$170	\$165	\$155
S-24578	5 x 9 x 3"	12 oz.			195	185	175
S-24579	6 x 9 x 3"	16 oz.			225	215	205
S-24580	7 x 11 x 4"	32 oz.			285	275	260



Unique airtight zipper

- Pull tab to open. Zipper to reseal.
- Heat sealable top.
- FDA and USDA compliant.



# HANG HOLE STAND-UP POUCHES

COLORS – GLOSSY SPECIFY COLOR: Black, Black Back or Silver Back

MODEL NO.	OUTSIDE DIM. W x H x D	HOLDS	MIL	QTY./ CTN.	PRICE PER CARTON		
					1	3	5+
S-24537	4 x 6 x 2"	2 oz.	5.0	1,000	\$125	\$120	\$115
S-24538	5 x 8 x 2½"	4 oz.			160	155	145
S-24539	6 x 9 x 3"	8 oz.			210	205	200

## CLEAR

S-24541	4 x 6 x 2"	2 oz.	5.0	1,000	\$115	\$110	\$105
S-24542	5 x 8 x 2½"	4 oz.			155	145	135
S-24543	6 x 9 x 3"	8 oz.			205	195	185

Pouches stand on shelves or hang from peg hooks.

- Airtight, reclosable zipper and thick barrier material seal in freshness.
- Heat sealable above tear notches.
- FDA and USDA compliant.



# CAKE AND BAKERY BOXES



FDA COMPLIANT

**BOXES** – Protect your cakes, cookies and pastries in these clean white boxes.

- 1-piece box with glossy exterior.

**PADS** – Support baked goods with sturdy grease-resistant pads.

Cupcake Inserts, see [uline.com](http://uline.com)



FDA COMPLIANT

## WHITE PLAIN BOXES (NO WINDOW)

MODEL NO.	SIZE W x D x H	QTY./CTN.	PRICE/CTN.	
			1	2+
S-17566	4½ x 4½ x 4½"	200	\$105	\$100
S-17916	6 x 6 x 3"	250	102	97
S-15469	6 x 6 x 4"	250	110	104
S-17917	8 x 4 x 4"	250	115	109
S-15470	8 x 8 x 4"	250	145	137
S-19921	9 x 9 x 2½"	250	136	129
S-16812	10 x 10 x 2½"	250	144	137
S-17918	10 x 10 x 3"	200	150	142
S-15471	10 x 10 x 4"	100	99	94
S-10694	10 x 10 x 5½"	100	111	105
S-12970	12 x 12 x 6"	50	82	78

## WHITE PLAIN BOXES (NO WINDOW) continued

MODEL NO.	SIZE W x D x H	QTY./CTN.	PRICE/CTN.	
			1	2+
S-12475	14 x 10 x 4"	100	\$113	\$107
S-13256	19 x 14 x 4"	50	109	103
S-14257*	26 x 18½ x 4"	25	94	89

## WHITE WINDOW BOXES

MODEL NO.	SIZE W x D x H	QTY./CTN.	PRICE/CTN.	
			1	2+
S-17565	4½ x 4½ x 4½"	200	\$188	\$178
S-19922	6 x 6 x 3"	200	163	153
S-16813	8 x 8 x 2½"	200	177	167
S-13254	8 x 8 x 4"	150	191	181
S-16814	9 x 9 x 2½"	200	195	184
S-15467	10 x 10 x 2½"	200	199	188
S-12967	10 x 10 x 5"	150	215	202

\* 2-piece box

## WHITE WINDOW BOXES continued

MODEL NO.	SIZE W x D x H	QTY./CTN.	PRICE/CTN.	
			1	2+
S-12476	14 x 10 x 4"	100	\$173	\$163
S-7981	19 x 14 x 4"	50	124	117

## WHITE PADS

MODEL NO.	USABLE DIMENSIONS	QTY./CTN.	PRICE/CTN.	
			1	2+
S-13257	6" Round	250	\$57	\$54
S-10637	8" Round	250	62	59
S-12477	10" Round	100	39	37
S-12478	12" Round	100	54	51
S-15473	16" Round	100	104	99
S-12487	14 x 10"	100	45	42
S-10639	18½" x 13½"	50	40	38

# CUPCAKE CONTAINERS New



Protect and display cupcakes and muffins in cafés and bakeries.

- Convenient 1-piece hinged design. Crystal clear plastic.
- Lock tabs secure lid and seal in freshness.



FDA COMPLIANT

MODEL NO.	DESCRIPTION	SIZE W x D x H	QTY./CTN.	PRICE/CTN.	
				1	3+
S-25143	1 Cupcake	5½ x 5 x 3"	400	\$122	\$117
S-25144	6 Cupcakes	7½ x 10 x 3"	250	137	132
S-25145	12 Cupcakes	9½ x 11 x 3"	100	132	127

# GUSSETED RECLOSABLE BAGS



Store and ship bottled liquid products and dry packaged food.

- Gusseted bottom lets product stand upright.
- Double-track zipper is ultra easy to use.

MEETS FDA AND USDA SPECIFICATIONS

MODEL NO.	USABLE DIM. W x H x D	HOLDS	MIL	QTY./CTN.	PRICE/CARTON		
					1	3	5+
S-10710	6 x 9 x 2"	8 oz.	2.0	1,000	\$47	\$44	\$40
S-10711	9 x 12 x 2"	12 oz.			71	67	63
S-14521	10 x 12 x 3"	14 oz.			91	87	82
S-12304	12 x 15 x 3"	20 oz.			115	110	105

# PARCHMENT PAPER



The nonstick wonder used in kitchens and bakeries.

**Quilon** – Single use, up to 390°F for 30 minutes.

**Silicone** – Multiple use, up to 480°F for 30 minutes.

FDA AND KOSHER COMPLIANT

MODEL NO.	COATING	DESCRIPTION	SIZE W x L	SHEETS/CTN.	PRICE/CTN.	
					1	5+
S-19144	Quilon	Half Pan	12 x 16"	2,000	\$78	\$73
S-19145		Full Pan	16 x 24"	1,000	76	71
S-23532	Silicone	Half Pan	12 x 16"	2,000	116	111
S-19146		Full Pan	16 x 24"	1,000	113	108



# FOOD PACKAGING



## BAKERY AND COFFEE BAGS

Pack your special cookies or custom coffees in these tab-lock bags.

- Laminated poly liner keeps contents fresh.
- FDA and USDA compliant.
- Metal tabs allow easy opening and a secure closure.

## GLASSINE BAGS

Attractive translucent bags for baked goods, small food items and film negatives.

- FDA and USDA compliant.
- Grease resistant.
- Use as liners to protect your products and packaging.

### WINDOW FRONT

MODEL NO.	SIZE W x D x H	COLOR	HOLDS	QTY./ CTN.	PRICE PER CARTON		
					1	3	5+
S-13248*	3 $\frac{3}{4}$ x 2 $\frac{1}{2}$ x 7 $\frac{3}{4}$ "	White	1/2 lb.	250	\$50	\$48	\$46
S-6908	4 $\frac{3}{4}$ x 2 $\frac{1}{2}$ x 9 $\frac{1}{2}$ "		1 lb.		55	52	50
S-6909	6 x 2 $\frac{3}{4}$ x 9 $\frac{1}{2}$ "		1 $\frac{1}{2}$ lbs.		60	58	56
S-13249*	3 $\frac{3}{8}$ x 2 $\frac{1}{2}$ x 7 $\frac{3}{4}$ "	Kraft	1/2 lb.	250	45	43	41
S-9672	4 $\frac{3}{4}$ x 2 $\frac{1}{2}$ x 9 $\frac{1}{2}$ "		1 lb.		49	47	45
S-13250	6 x 2 $\frac{3}{4}$ x 9 $\frac{1}{2}$ "		1 $\frac{1}{2}$ lbs.		55	52	50

### PLAIN FRONT (NO WINDOW)

MODEL NO.	SIZE W x D x H	COLOR	HOLDS	QTY./ CTN.	PRICE PER CARTON		
					1	3	5+
S-6905	3 $\frac{3}{8}$ x 2 $\frac{1}{2}$ x 9 $\frac{3}{8}$ "	White	1/2 lb.	250	\$52	\$50	\$48
S-6906	4 $\frac{3}{4}$ x 3 $\frac{1}{4}$ x 9"		1 lb.		57	55	52
S-6907	4 $\frac{3}{4}$ x 3 $\frac{1}{4}$ x 11"		2 lbs.		59	57	55
S-18224	3 $\frac{3}{8}$ x 2 $\frac{1}{2}$ x 7 $\frac{3}{4}$ "	Kraft	1/2 lb.	250	46	44	42
S-9800	3 $\frac{3}{8}$ x 2 $\frac{1}{2}$ x 10 $\frac{3}{8}$ "		1 lb.		47	45	43
S-9801	4 $\frac{3}{4}$ x 3 $\frac{1}{4}$ x 9"		1 lb.		51	49	47
S-20616	6 $\frac{1}{2}$ x 4 x 18"		5 lbs.		137	134	130

\*Round Window

### GLASSINE BAGS

MODEL NO.	SIZE W x L	STYLE	HOLDS	QTY./ CTN.	PRICE PER CARTON		
					1	3	5+
S-11591	2 x 3 $\frac{1}{2}$ "	Flat	Sugar Ration	2,000	\$31	\$30	\$29
S-12470	2 $\frac{1}{4}$ x 4 $\frac{1}{4}$ "	Flat	1 oz.	1,000	28	27	26
S-13251	3 x 5 $\frac{1}{2}$ "		No. 1 Peanut		29	28	27
S-8548	3 $\frac{3}{4}$ x 6 $\frac{1}{4}$ "		1/4 lb.		33	32	31
S-13252	4 x 7 $\frac{1}{2}$ "		1/2 lb.		46	45	43
S-8549	4 $\frac{1}{2}$ x 6 $\frac{3}{4}$ "		1/2 lb.		39	38	36
S-8550	5 $\frac{1}{2}$ x 7 $\frac{3}{4}$ "		1 lb.		44	43	41
S-12471	11 $\frac{1}{2}$ x 12"		Coffee Cake		114	110	106
S-9611	4 x 2 $\frac{1}{2}$ x 8 $\frac{1}{2}$ "	Gusseted	2 lbs.	1,000	52	50	48
S-11592	4 $\frac{1}{2}$ x 3 $\frac{1}{4}$ x 9 $\frac{3}{4}$ "		3 lbs.		70	68	65
S-12472	6 x 3 $\frac{1}{2}$ x 13"		6# Popcorn		108	104	100



FDA COMPLIANT

Pop-up box with glossy exterior.

- Pads for multilayer packaging and top layer protection.

## CANDY BOXES

### ONE PIECE

MODEL NO.	SIZE W x D x H	HOLDS	QTY./ CTN.	PRICE/CTN.	
				1	2+
S-8569	5 $\frac{1}{2}$ x 2 $\frac{3}{4}$ x 1 $\frac{3}{4}$ "	1/2 lb.	250	\$71	\$68
S-8570	7 $\frac{1}{8}$ x 3 $\frac{3}{8}$ x 1 $\frac{1}{8}$ "	1 lb.		89	85
S-9835	8 $\frac{3}{8}$ x 3 $\frac{3}{4}$ x 2 $\frac{3}{8}$ "	2 lbs.		134	128
S-9820	10 $\frac{3}{8}$ x 4 $\frac{1}{4}$ x 2 $\frac{1}{2}$ "	3 lbs.		209	199

### PADS (CORRESPONDING)

MODEL NO.	QTY./ CTN.	PRICE/CTN.	
		1	2+
S-12463	250	\$23	\$22
S-12464	250	27	26
S-12465	250	39	37
-	-	-	-

### TWO PIECE

MODEL NO.	SIZE W x D x H	HOLDS	QTY./ CTN.	PRICE/CTN.	
				1	2+
S-12462	7 x 4 $\frac{3}{8}$ x 1 $\frac{1}{8}$ "	1/2 lb.	250	\$167	\$159
S-7982	9 $\frac{3}{8}$ x 5 $\frac{3}{8}$ x 1 $\frac{1}{8}$ "	1 lb.	125	95	91
S-8571	9 $\frac{3}{8}$ x 5 $\frac{3}{8}$ x 2"	2 lbs.		133	127

### PADS (CORRESPONDING)

MODEL NO.	QTY./ CTN.	PRICE/CTN.	
		1	2+
S-12466	250	\$37	\$35
S-12467	125	26	25

# FOOD STORAGE BOXES

RUBBERMAID®



Store bulk fruits and vegetables in commercial kitchens.

- Space saving. Stack when full or nest when empty. Snap-tight lids.
- Clear, break-resistant polycarbonate stands up to heavy use and frequent washings.
- Temperature range -50° to 212°F. • FDA, USDA and HACCP compliant. NSF certified.

## BOXES

White, see uLINE.com

MODEL NO.	OUTSIDE DIM. L x W x H	CAPACITY	QTY./CTN.	PRICE EACH	
				6	12+
S-21498	18 x 12 x 6"	3½ Gal.	6	\$26	\$24
S-21499	18 x 12 x 9"	5 Gal.		36	33
S-21500	26 x 18 x 6"	8½ Gal.	6	48	44
S-21501	26 x 18 x 9"	12½ Gal.		69	65

## LIDS

MODEL NO.	QTY./CTN.	PRICE EACH	
		6	12+
S-21502	6	\$14	\$13
S-21503	6	26	24

SOLD IN CARTON QUANTITIES

# SCOOPS

DISHWASHER SAFE

## COLORED PLASTIC



- Seamless, unbreakable polypropylene.
- Color coded for food safety.
- Use with food storage containers.

REMCO SPECIFY COLOR: Blue, Red, White or Yellow

MODEL NO.	CAPACITY	PRICE EACH (MIN. 6)	
		6	12+
H-10134	32 oz.	\$8	\$7
H-10135	82 oz.	10	9

FDA COMPLIANT

## CLEAR PLASTIC



- Tough, durable polycarbonate construction.
- Resists stains and scratches.
- Use with ice bags and ingredient bins.

RUBBERMAID®

MODEL NO.	CAPACITY	PRICE EACH	
		1	3+
H-4867	32 oz.	\$14	\$13
H-4868	64 oz.	16	15

NSF CERTIFIED

## STAINLESS STEEL



- Type 304. Resists rust and corrosion.
- Polished finish is easy to clean.
- Use with drums and bulk bags.

MODEL NO.	CAPACITY	PRICE EACH	
		1	3+
H-4869	32 oz.	\$76	\$70
H-4870	64 oz.	82	75

NSF CERTIFIED

# COLORED HAND SCRAPERS *New*

REMCO



Remove stuck, burnt-on food or debris from countertops and machinery.

- Color coding reduces the risk of cross-contamination.
- One-piece polypropylene construction. No seams to prevent bacteria growth.

SPECIFY COLOR: Black Green Yellow Red Blue Orange White

MODEL NO.	DESCRIPTION	SIZE W x L	PRICE EACH (MIN. 6)	
			6	12+
H-10727	Hand Scraper	3 x 8"	\$7	\$6
H-10728		4 x 9"	8	7

FDA COMPLIANT



LIGHT DUTY

Durable polypropylene resists denting and cracking.

# ICE TOTES *New*

SAN JAMAR®

Transport ice from the icemaker to the bar, from the cooler to the buffet or to stock up your YETI®.

- Prevents contamination. Easy to fill, carry and pour.
- Built-in hook for upside down drying and storage.

NSF CERTIFIED

MODEL NO.	DESCRIPTION	CAPACITY	PRICE EACH	
			1	3+
H-10729	Light Duty Ice Tote	6 Gallon	\$49	\$45
H-10730	Heavy Duty Ice Tote	6 Gallon	70	66



HEAVY DUTY

Break-resistant polycarbonate stands up to daily use.

# RUBBERMAID® INGREDIENT BINS

Store heavy bulk items such as dry beans, pasta and flour.

- Recommended for commercial kitchens, restaurants and bakeries.
- Clear sliding lid provides content visibility. Plastic scoop included.

**Mobile Bins** – Fit under most counters. Roll easily from storage to prep areas with 3" casters: 2 swivel, 2 rigid.

**Shelf Bins** – Fit most standard shelves. Quick, one-handed access when stacked. First in, first out divider for proper product rotation.



## MOBILE BINS FDA AND USDA COMPLIANT. NSF CERTIFIED.

MODEL NO.	OUTSIDE DIM. L x W x H	CAPACITY	WT. (LBS.)	PRICE EACH	
				1	2+
H-3559	29 x 13 x 29"	25 Gal.	28	\$320	\$310
H-3560	29 x 15 x 29"	31 Gal.	31	337	326
H-3561	29 x 18 x 29"	38 Gal.	33	343	332

## SHELF BINS FDA AND USDA COMPLIANT. NSF CERTIFIED.

MODEL NO.	OUTSIDE DIM. L x W x H	CAPACITY	WT. (LBS.)	PRICE EACH	
				1	2+
H-4042	15 x 12 x 9"	40 Cups	4	\$93	\$90
H-4043	24 x 12 x 17"	100 Cups	14	174	169
H-4044	24 x 20 x 17"	200 Cups	19	243	236



### Round Bins

- Clear, rotating lid provides quick, one-handed access.
- Plastic scoop included.
- Brutes and Dollies complete line, see page 397.

## ROUND BINS USDA COMPLIANT. NSF CERTIFIED.

MODEL NO.	OUTSIDE DIM. L x W x H	CAPACITY	WT. (LBS.)	PRICE EACH	
				1	2+
H-5081	19 x 17 x 19"	10 Gal.	8	\$80	\$77
H-5082	23 x 21 x 25"	20 Gal.	11	115	110
H-5083	26 x 24 x 30"	32 Gal.	14	140	135

# FOOD STORAGE CONTAINERS

Store ingredients, toppings and leftovers in restaurants and bakeries. Lasts for years.

- Durable polycarbonate with measurements for bulk food prep. Dishwasher safe.

More styles available, see [uline.com](http://uline.com)

MODEL NO.	OUTSIDE DIM. L x W x H	CAPACITY	QTY./CTN.	PRICE EACH	
				6	12+
S-21881	7 x 7 x 4"	2 Quart	6	\$8	\$7
S-21882	7 x 7 x 7"	4 Quart		12	11
S-21883	8 x 8 x 9"	8 Quart	6	16	15
S-22308	11 x 12 x 8"	12 Quart	6	24	22
S-21884	11 x 12 x 16"	22 Quart		39	36

SOLD IN CARTON QUANTITIES

## CAMBRO®

- Temperature range -40° to 210°F.
- Nestable. Stackable with optional color-coded lids, see [uline.com](http://uline.com)
- NSF listed.



# COMMERCIAL MEASURING CUPS

Chef's best friend. Measure hot and cold ingredients precisely.

- Durable polycarbonate with measurements on both sides. Dishwasher safe.

MODEL NO.	DIMENSIONS L x W x H	CAPACITY	QTY./CTN.	PRICE/CARTON	
				1	3+
S-24377	6 x 5 x 6"	1 Quart	12	\$85	\$80
S-24378	7 x 6 x 9"	2 Quart	6	75	70
S-24379	9 x 8 x 11"	4 Quart	4	75	70

- Temperature range -40° to 210°F.
- Tapered lip for clean pouring from front or sides.
- NSF listed.





# MOBILE PAN RACKS



Easily transfer or display bakery items. Move parts during in-process work.

- All-welded aluminum construction.
- **Half-Height Rack** – Holds (10) 18 x 26" Pans or (20) 13 x 18" Pans.
- **Full-Height Rack** – Holds (20) 18 x 26" Pans or (40) 13 x 18" Pans.
- Slides are 3" apart for easy access.
- 5" polyurethane swivel casters.



H-6468

## COVERS

Slide over rack. Protect foods and maintain freshness.

- Compatible with Full-Height Racks.

## RACKS

MODEL NO.	DESCRIPTION	SIZE W x L x H	LOAD CAP.	WT. (LBS.)	PRICE EACH	
					1	2+
H-6468	Half Height	21 x 26 x 38"	800 lbs.	23	\$309	\$299
H-4000	Full Height	21 x 26 x 70"		30	369	359

SHIPS ASSEMBLED VIA MOTOR FREIGHT

## COVERS

MODEL NO.	DESCRIPTION	SIZE W x L x H	THICK. (MIL)	QTY./ CTN.	PRICE/CARTON	
					1	2+
S-21385	Disposable	52 x 80"	0.6	50	\$34	\$33
S-21386	Clear Vinyl	24 x 28 x 62"	7	1	24	23
S-23508	Freezer	25 x 28 x 62"	13	1	99	94

# BAKING PANS



Executive chef approved.

- Withstands demands of commercial kitchens.

**Aluminum Pans** – Bake cookies, pastries and breads. 18-gauge, tempered aluminum alloy browns food evenly.

**Wire Grate** – Elevate food off the pan during cooking and cooling. Stainless steel mesh for even airflow.

## ALUMINUM PANS

MODEL NO.	DESCRIPTION	SIZE W x L x D	WT. (LBS.)	PRICE/PAN (MIN. 12)	
				12	24+
H-8545	Half Sheet	13 x 18 x 1"	2	\$10	\$9
H-4001	Full Sheet	18 x 26 x 1"	4	18	17
<b>WIRE GRATE</b>				6	12+
H-8578*	Full Sheet	16 x 24 x 7/8"	3	\$28	\$25

\*MIN. 6

# PERFORATED BAKING PANS



Bake flaky croissants, curly fries and toasted flatbreads.

- Perforations increase airflow for faster baking and a crispy finish.
- Sturdy 18-gauge aluminum.

MODEL NO.	DESCRIPTION	SIZE W x L x D	WT. (LBS.)	PRICE/PAN (MIN. 12)	
				12	24+
H-10762	Half Sheet	13 x 18 x 1"	2	\$10	\$9
H-10763	Full Sheet	18 x 26 x 1"	3	18	17

# COMMERCIAL MIXING BOWLS

Not your grandma's mixing bowls.

- Withstands daily use in high-volume kitchens.
- Durable yet lightweight **27-gauge stainless steel.**
- Resists rust and corrosion.
- Sizes nest for storage. Dishwasher safe.



## STAINLESS STEEL

MODEL NO.	SIZE DIAM. x H	QUART CAPACITY	QTY./ CTN.	PRICE PER CARTON		
				1	2	3+
H-9813	10¼ x 3½"	3	12	\$60	\$58	\$56
H-9814	11¾ x 4"	5		86	83	80
H-9815	13¾ x 5"	8		120	115	110
H-9816	16½ x 5½"	13		170	165	160
H-9817	19¼ x 6½"	20		275	265	255

# DISPLAY TRAYS

Showcase signature desserts in bakeries and coffee shops.

- Dishwasher safe.
- Fiberglass resists scratching and chipping.



Lightweight and stackable

## FIBERGLASS

SPECIFY COLOR: Black or White

MODEL NO.	DESCRIPTION	SIZE W x L x D	WT. (LBS.)	PRICE/PAN (MIN. 12)	
				12	24+
H-10764	Narrow Sheet	9 x 26 x 1½"	2	\$20	\$19
H-10765	Half Sheet	12 x 18 x 1"	2	22	21
H-4002	Full Sheet	18 x 26 x 1½"	4	25	24

# FOODSAVER® BAGS

Seal freshness in. Block out moisture and oxygen. Prevent freezer burn.

FDA COMPLIANT. BPA FREE.

MODEL NO.	SIZE	DESCRIPTION	QTY./CTN.	PRICE PER CARTON		
				1	2	5+
S-19138	6 x 9"	Pint Bag	28	\$18	\$17	\$15
S-18140	8 x 10"	Quart Bag	44	30	29	28
S-24042	11 x 14"	Gallon Bag	13	16	15	14
S-25491	8" x 15'	FoodSaver® Heat-Seal Roll	2	23	22	21
S-25492	11" x 12'					
S-20395	6 x 10"	Uline Pint Bag		16	15	14
S-19920	8 x 12"	Uline Quart Bag	100	24	23	22
S-20396	11½ x 14"	Uline Gallon Bag		41	39	37
S-19139	8" x 50'	Uline Jumbo Roll	1	18	16	14
S-19140	11½" x 50'			23	21	19
H-6676	FoodSaver® FM 5200 Vacuum			\$260 each		

- Excellent for fish, game and vegetables.
- 5-ply construction creates an airtight barrier.
- Can be frozen, refrigerated, microwaved, boiled and washed.



FoodSaver® Vacuum Sealer  
more information, see [uline.com](http://uline.com)

## COMMERCIAL CUTTING BOARDS



Chef approved for safe slicing, dicing and chopping.

- Rubber corner grips prevent slipping.
- Embossed ruler for accurate food portioning.
- Convenient carrying handle.
- Dishwasher safe.

Assortment Pack – Color coding prevents cross-contamination. Includes one each: White, Yellow, Red, Green, Blue and Brown.

SPECIFY COLOR: White or Assortment Pack

MODEL NO.	DESCRIPTION	SIZE W x L x H	QTY./CTN.	PRICE PER CARTON	
				1	2+
S-24553		12 x 18 x 1/2"		\$79	\$74
S-24554	Polypropylene	15 x 20 x 1/2"	6	105	100
S-24555		18 x 24 x 1/2"		152	142

## MIXING PADDLES

Mix and scrape vats of soup and sauces in commercial kitchens.

- Seamless, sanitary one-piece construction. Virtually unbreakable.
- Long handle extends deep into tall pots.

Type 304 Stainless Steel – Resists harsh cleanings and corrosive environments.

Polypropylene – Won't scratch pots and pans. Color coded for food safety.



\* SPECIFY COLOR: Red Blue Green White Yellow

MODEL NO.	DESCRIPTION	OVERALL LENGTH	BLADE SIZE	PRICE EACH	
				1	3+
H-9721	Stainless Steel	48"	5 x 9"	\$35	\$32
H-9722*	Polypropylene	40"	6 x 13"	51	48
H-9723*		52"		56	53

## FOOD SERVING PANS

Easily customize your buffet table, banquet station or salad bar.

- Holds cold sides, salad toppings, fruits and vegetables.
- Tough, clear polycarbonate resists stains and odors.

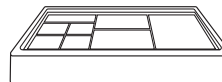

CAMBRO®



Temperature range -40° to 210°F.  
Dishwasher safe.

Nestable. Stackable with optional lids.  
NSF listed.

### PANS

MODEL NO.	OUTSIDE DIM. L x W x D	PAN SIZE	CAPACITY	QTY./CTN.	PRICE/CTN.	
					1	2+
S-24621	7 x 6 x 6"	1/6	2 Quart		\$50	\$47
S-24622	13 x 7 x 6"	1/3	6 Quart	6	74	68
S-24623	13 x 10 x 6"	1/2	9 Quart		96	90
S-24624	21 x 13 x 6"	Full	21 Quart		168	158

### LIDS

MODEL NO.	QTY./CTN.	PRICE/CTN.	
		1	2+
S-24625		\$28	\$26
S-24626	6	37	34
S-24627		48	45
S-24628		91	86

# CASH REGISTER PAPER



Print a high-quality record of all your transactions.

**Thermal** – For cash registers, ATM machines and gas stations. No ribbon required.

**1-Ply Bond** – Recommended for kitchen printers, calculators and adding machines.

**2-Ply Carbonless** – Ideal for credit card machines and impact printers to create two receipts at one time.

\*RIBBON REQUIRED

MODEL NO.	SIZE W x L	DESCRIPTION	QTY./CTN.	LBS./CTN.	PRICE/CARTON			
					1	3+		
S-18643	44 mm x 230'	Thermal	50	17	\$71	\$69		
S-18644	2¼" x 50'			6	29	28		
S-16160	2¼" x 85'			9	39	38		
S-18645	2¼" x 165'			16	70	67		
S-18646	2¼" x 230'			21	91	89		
S-19680	3⅞" x 119'			15	78	76		
S-16161	3⅞" x 230'			30	\$99/ctn. any qty.			
S-16162	3⅞" x 273'			35	122	120		
S-16163*	2¼" x 150'			1-Ply Bond		17	46	45
S-16164*	3" x 165'					25	60	58
S-16165*	3" x 90'	2-Ply Carbonless		23	75	73		

# SUPER TOUGH T-SHIRT BAGS

LOW DENSITY



Our thickest T-shirt bag. Pack it all in and carry it around all day.

- Holds your heaviest home décor purchases.
- Reusable and recyclable.
- Strong, wide handles for easy carrying.
- Resists punctures and tears.
- Complete line, see pages 166-168.

MODEL NO.	DESC.	SIZE W x D x L	MIL	QTY./CTN.	PRICE/CARTON		
					1	5	10+
S-22794	Plain Clear	12 x 7 x 22"	2.25	500	\$117	\$111	\$106
S-22796		20 x 10 x 30"		250	127	122	117
S-22793	"Thank You" Script	12 x 7 x 22"	2.25	500	127	122	117
S-22795		20 x 10 x 30"		250	144	139	132

# PALLET SIGN HOLDER



Draw attention to seasonal and bulk merchandise displays.

- Double-sided, free-swinging frame loads easily from side.
- Sturdy base slips easily under pallets and gaylords.
- Height adjusts from 50-70".

**Clear Inserts** – Scratch-resistant plastic protects signs.

SIGN HOLDER				CLEAR INSERTS			
MODEL NO.	SIGN SIZE W x L	WT. (LBS.)	QTY./CTN.	PRICE PER CARTON		MODEL NO.	PRICE PER CARTON OF 4
				1	3+		
H-7870	14 x 11"	24	2	\$95	\$90	H-8593	\$22

BOX				SHIPS VIA MOTOR FREIGHT			
MODEL NO.	INSIDE DIMENSIONS L x W x H	TEST	HOLDS MAX. WT.	PRICE/BOX (MIN. 5)			
				5	25	100+	
S-12707	46 x 38 x 36"	1,300# TW	2,200 lbs.	\$93	\$90	\$86	

# JUMBO TAKE-OUT BAGS



LOW DENSITY

Feed the whole crew. Package and transport large, heavy carryout orders.

- Chipboard bottom and plastic handles.
- Extra-thick 2.5 mil low-density polyethylene.

MODEL NO.	SIZE W x D x H	QTY./CTN.	PRICE PER CARTON		
			1	3	5+
S-25064	19 x 10 x 12"	100	\$140	\$135	\$130
S-25065	22 x 14 x 15"		190	185	180



# FLOOR STANDING SIGN HOLDERS

## SINGLE TIER

SPECIFY COLOR: Chrome or Black

MODEL NO.	SIGN SIZE W x H	HEIGHT	WT. (LBS.)	PRICE EACH	
				1	3+
H-5712	14 x 22"	54"	18	\$46	\$42
H-5713	22 x 28"	61"	19	65	60
H-7014	24 x 36"	70"	24	75	69
H-7871	28 x 22"	60"	20	73	67

EASY ASSEMBLY. SHIPS VIA UPS.

## DOUBLE TIER

SPECIFY COLOR: Chrome or Black

MODEL NO.	SIGN SIZE W x H	HEIGHT	WT. (LBS.)	PRICE EACH	
				1	3+
H-7869	22 x 28"	61"	20	\$91	\$84

EASY ASSEMBLY. SHIPS VIA UPS.

## THREE TIER

SPECIFY COLOR: Chrome or Black

MODEL NO.	SIGN SIZE W x H	HEIGHT	WT. (LBS.)	PRICE EACH	
				1	3+
H-9687	22 x 28"	85"	23	\$155	\$145

SHIPS VIA MOTOR FREIGHT

## CLEAR PROTECTIVE INSERTS

MODEL NO.	SIGN HOLDER SIZE	THICKNESS	QTY./CTN.	PRICE PER CARTON	
				1	3+
H-7167	14 x 22"			\$16	\$15
H-7168	22 x 28"	.04"	2	31	29
H-7169	24 x 36"			43	41

Advertise your events or special announcements.

Single Tier – Signs easily slide in from the top to the bottom.

Double Tier – Holds two 22 x 28" posters. Loads from side.

Three Tier – Triple the merchandising space. Holds three 22 x 28" posters. Loads from side.

Clear Inserts – Scratch-resistant plastic protects posters.



# PAPER TAKE-OUT BAGS

Quickly package carryout entrées, salads and pasta dishes.

- Flat-bottom gusseted bags stand alone for fast packing.
- Reinforced die-cut handles.



## KRAFT

MODEL NO.	SIZE W x D x H	BASIS WEIGHT	QTY./CTN.	PRICE PER CARTON			LBS./CTN.
				1	5	10+	
S-23512	7 1/2 x 3 1/4 x 10 3/4"	60 lb.	250	\$85	\$80	\$75	14
S-23513	8 x 4 x 13 5/8"	60 lb.	250	95	90	85	19
S-23514	11 x 6 x 11"	40 lb.	500	145	140	135	26

## WHITE

MODEL NO.	SIZE W x D x H	BASIS WEIGHT	QTY./CTN.	PRICE PER CARTON			LBS./CTN.
				1	5	10+	
S-23515	7 1/2 x 3 1/4 x 10 3/4"	60 lb.	250	\$95	\$90	\$85	14
S-23516	8 x 4 x 13 5/8"	60 lb.	250	105	100	95	19
S-23517	11 x 6 x 11"	40 lb.	500	160	155	150	26

# TAKE-OUT BAGS HIGH DENSITY

Package bulky merchandise. Wide-mouth bags, ideal for carryout.

- Large-bottom gusset bags stand alone for fast packing.
- Durable high-density film.

Colored – Stronger, tear-resistant for heavier packages.



## WHITE

MODEL NO.	SIZE W x L x D	USE FOR	MIL	QTY./CTN.	PRICE PER CARTON		
					1	3	5+
S-9700	19 x 18 x 9 1/2"	Chinese Take-Out, Bakery	1.4	500	\$89	\$81	\$75
S-9701	21 x 18 x 10"				98	91	84
S-9702	24 x 20 x 11"				69	64	60

## COLORED

SPECIFY COLOR: Blue, Lime or Clear

MODEL NO.	SIZE W x L x D	USE FOR	MIL	QTY./CTN.	PRICE PER CARTON		
					1	3	5+
S-16807	12 x 11 x 4"	Ribs, Chicken	2.0	250	\$48	\$46	\$44
S-16808	18 x 15 x 6"				71	68	65
S-16809	22 x 18 x 8"				97	93	90



## HEAVY DUTY SNAP EDGE SIGNS

Weatherproof sidewalk sign handles winds up to 60 mph.

- Quickly change signage with aluminum snap edges.
- 1½" double-sided, weather-resistant frame and cover.
- 2 wheels and hidden handle for easy portability.
- Reservoir Base – Fill with sand for added stability.

WINDPRO®

SPECIFY COLOR: Black or Silver

MODEL NO.	DESCRIPTION	SIZE W x H	SIGN SIZE W x H	WT. (LBS.)	PRICE EACH	
					1	3+
H-7041	Wind Sign	29 x 49"	24 x 36"	35	\$240	\$220
H-8546		35 x 53"	30 x 40"	40	295	275

EASY ASSEMBLY. SHIPS VIA UPS.



Quickly update visuals.  
Outside edges flip open for quick changes.

## SNAP EDGE FRAME SIGNS WALL-MOUNT

Mounting hardware included

SPECIFY COLOR: Black or Silver

MODEL NO.	SIGN SIZE W x H	SUGGESTED USE	QTY./ CTN.	PRICE/SIGN	
				2	10+
S-21325*	8½ x 11"	Documents/Certificates	10	\$15	\$14
S-22813	11 x 14"			20	19
S-21326*	11 x 17"	Posters/Advertisements	10	21	20
S-23416	16 x 20"			30	29
S-22814	18 x 24"			38	36
S-21327	22 x 28"			48	46
S-22290*	24 x 36"			62	60
S-22815	30 x 40"	80	75		

\*Also available in White



Sleek, 1" profile aluminum body with non-glare plastic cover.

## PLATFORM LUGGAGE CART

Pile on all your luggage. Recommended for trade shows, banquet halls and resorts.

- Welded steel base with sleek black polyester carpet.
- Upright handle for easy control.
- Wraparound bumper protects walls.
- Coated stainless steel frame.
- 8" pneumatic casters: 2 swivel, 2 rigid.



MODEL NO.	DESCRIPTION	DIMENSIONS L x W x H	LOAD CAPACITY	WT. (LBS.)	PRICE EACH	
					1	2+
H-10097	Platform	45 x 26 x 38"	1,100 lbs.	94	\$675	\$655

SHIPS UNASSEMBLED VIA MOTOR FREIGHT



## LUGGAGE CARTS

The gold standard for hotels, motels, convention centers and condominiums.

- Welded steel base with durable polyester carpet.
- Garment bar for hanging 20-50 jackets and bags.
- 8" pneumatic casters: 2 swivel, 2 rigid.

\*SPECIFY COLOR: Brass or Silver

SHIPS UNASSEMBLED VIA MOTOR FREIGHT

MODEL NO.	DESCRIPTION	DIMENSIONS L x W x H	LOAD CAPACITY	WT. (LBS.)	PRICE EACH	
					1	2+
H-8588	Narrow	40 x 22 x 74"	1,100 lbs.	97	\$745	\$725
H-5010*	Bellman	43 x 26 x 78"		108	765	745



Bellman



Narrow

# A-FRAME SIGNS

## WOOD FRAMES

Promote lunch specials, daily entertainment and special events.

- 2-sided boards with attractive wood frames and self-leveling feet.

**Markerboard** – Glossy melamine surface erases cleanly. Use with dry erase or chalk ink markers only.

**Chalkboard** – Inform customers of events and promotions. Use with chalkboard chalk.



Markers and chalk available, see [uline.com](http://uline.com)



MODEL NO.	DESCRIPTION	FRAME	SIZE W x H	WRITABLE AREA	WT. (LBS.)	PRICE EACH	
						1	3+
H-5104	White Markerboard	Oak	24 x 42"	21 x 34"	18	\$160	\$150
H-5903	Black Markerboard	Cherry	24 x 42"	21 x 34"	20	175	165
H-5105	Chalkboard	Cherry	24 x 42"	21 x 34"	19	175	165

## JUMBO PLASTIC



Big and bold. Recommended for messages that need to "pop."

- 2-sided plastic frame provides 360° messaging.
- "Quick change" tabs secure sign. No tape or screws needed.
- 2 wheels and handle for easy mobility.

SHIPS VIA MOTOR FREIGHT

MODEL NO.	DESCRIPTION	SIZE W x H	SIGN AREA W x H	WT. (LBS.)	PRICE EACH	
					1	3+
H-9725	Billboard™	39 x 58"	36 x 48"	45	\$360	\$330

## PLASTIC

Popular style used everywhere from retail shops to parks and construction areas.

- 2-sided frame for indoor and outdoor use.

**Standard** – Attach sign with double-sided tape, Velcro® or screws.

**Deluxe** – "Quick change" tabs hold sign in place. No tape or screws needed!



SIGNICADE® SPECIFY COLOR:  White  Black  Yellow

MODEL NO.	DESCRIPTION	SIZE W x H	SIGN AREA W x H	WT. (LBS.)	PRICE EACH	
					1	3+
H-6104	Standard	25 x 45"	24 x 36"	18	\$110	\$105
H-7902*	Deluxe	27 x 46"	24 x 36"	20	130	125

\*Available in White and Black only

## PEDESTAL SIGN HOLDERS



Sleek, curved displays get noticed in lobbies, galleries and cafés.

- Frame edges flip open for quick changes.
- Easily rotates from portrait to landscape position.
- Non-glare plastic cover protects signs and posters.

SPECIFY COLOR: Black or Silver

MODEL NO.	DESCRIPTION	SIGN SIZE W x H	HT.	WT. (LBS.)	PRICE EACH	
					1	3+
H-6328	Pedestal	8½ x 11"	48"	10	\$100	\$95
H-6329		11 x 17"	50"	11	105	100

EASY ASSEMBLY. SHIPS VIA UPS.

## ALUMINUM SNAP EDGE

Easily update your sidewalk promotions. Sleek and stylish.

- Outside edges flip open for quick changes.
- 1¼" aluminum frame.
- Weather-resistant cover.
- Sturdy. Use indoors and out.



SPECIFY COLOR: Black or Silver

MODEL NO.	FRAME	SIZE W x H	SIGN SIZE W x H	WT. (LBS.)	PRICE EACH	
					1	3+
H-6327	Aluminum	24 x 40"	22 x 28"	21	\$165	\$150



# SINGLE SHEET HOLDERS

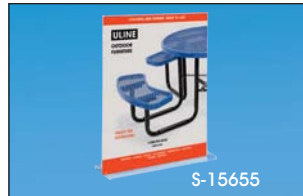

Full-view clear acrylic displays for promotions or product information.

**T-Style** – Holds two sheets back-to-back or one two-sided sheet. Easy top loading.

**Slanted** – Shows off single-sided material. Side loading.

**Wall-Mount** – Pre-drilled holes for easy installation.

▲With Attached Business Card Holder

MODEL NO.	DESCRIPTION	SIZE W x H	QTY./CTN.	PRICE PER CARTON		
				1	2	3+
S-20964	T-Style	4 x 6"	4	\$20	\$18	\$16
S-15654		5 x 7"		23	21	19
S-15655		8½ x 11"		44	41	37
S-20965		11 x 8½"		44	41	37
S-15658	Slanted	4 x 6"	4	20	18	16
S-13383		5 x 7"		23	21	19
S-13384		8½ x 11"		43	40	36
S-15660▲		8½ x 11"		48	44	40
S-19918*	Wall-Mount	8½ x 11"	4	37	35	33
S-22005*		11 x 8½"		37	35	32
S-22006*		11 x 17"		74	70	66
S-23549*		17 x 11"		74	70	66

\* Mounting hardware not included

# BROCHURE HOLDERS



Crystal clear, attractive, long-lasting acrylic.

- Display pamphlets, business cards and brochures.
- Slant back design keeps literature in place.

**Slanted** – Single-sided countertop display.

**Wall-Mount** – For eye-level display of booklets.

SLANTED

▲With Attached Business Card Holder

MODEL NO.	DESCRIPTION	SIZE W x D x H	QTY./CTN.	PRICE PER CARTON		
				1	2	3+
S-8398	Business Cards	4 x 2 x 3"	20	\$28	\$26	\$24
S-8260	Pamphlets	4 x 3 x 7"	10	30	28	25
S-20966	Booklet	6 x 4 x 7"	10	53	49	45
S-8337	Literature	9 x 4 x 10"	10	69	63	58
S-15684▲	Lit. w/ Bus. Card	9 x 4 x 10"	10	85	81	77

WALL-MOUNT

MODEL NO.	DESCRIPTION	SIZE W x D x H	QTY./CTN.	PRICE PER CARTON		
				1	2	3+
S-18619	Pamphlets	4 x 1½ x 6½"	10	\$29	\$28	\$26
S-15685	Booklets	6 x 1¼ x 6½"		50	48	46
S-15686	Literature	9 x 1¼ x 9½"		74	73	71

Mounting hardware not included

# TIERED LITERATURE HOLDERS



Slanted "steps" keep literature visible and accessible.

- Saves space, organizes pamphlets and brochures.
- Free-standing or wall-mount. Sturdy, crystal clear acrylic.

Mounting hardware not included

MODEL NO.	DESCRIPTION	SIZE W x D x H	QTY./CTN.	PRICE PER CARTON		
				1	2	3+
S-15683	4-Tier Bus. Card	4 x 4 x 4"	2	\$12	\$11	\$10
S-12206	4-Tier Pamphlet	4 x 6 x 10"		30	28	26
S-12205	3-Tier Literature	9 x 6 x 13"		34	32	30

# OUTDOOR BROCHURE HOLDER



Frosted, attractive, long-lasting polystyrene.

- Self-closing lid keeps weather off.
- Holds 250 sheets up to 8½ x 11".

MODEL NO.	SIZE W x D x H	QTY./CTN.	PRICE PER CARTON		
			1	2	3+
S-12207	9 x 2 x 13"	2	\$38	\$36	\$34

# MAGAZINE RACK

Wall-mount acrylic display.

- Features 9 pockets for magazines.
- Crystal clear, professional look.

MODEL NO.	SIZE W x D x H	WT. (LBS.)	PRICE EACH	
			1	5+
H-2519	31 x 2 x 39"	20	\$270	\$250

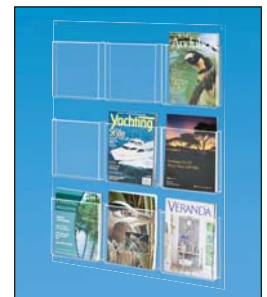

# EASEL BACKS

SELF-ADHESIVE

## SINGLE WING – ECONOMY

SPECIFY COLOR: Black or White

MODEL NO.	EASEL SIZE	SIGN HEIGHT	THICK-NESS	QTY./ CTN.	PRICE PER CARTON		
					1	3	5+
S-18202	3"	5"	.040"	100	\$25	\$23	\$21
S-18203	5"	7"			29	27	24
S-17092	7"	9"			37	35	32
S-17093	9"	12"			43	41	37
S-17094	12"	15"			52	50	46
S-17095	15"	17"		50	51	49	45

BOARD NOT INCLUDED

## DOUBLE WING – DELUXE

SPECIFY COLOR: Black or White

MODEL NO.	EASEL SIZE	SIGN HEIGHT	THICK-NESS	QTY./ CTN.	PRICE PER CARTON		
					1	3	5+
S-15487	5"	7"	.040"	50	\$29	\$27	\$24
S-17084	6"	8"			32	30	27
S-12943	7"	9"			34	32	29
S-19120	8"	10"			36	34	31
S-12944	9"	11"			39	37	34
S-15488	12"	14"			47	45	42
S-15489	15"	17"			55	52	49
S-17090	18"	20"			67	64	59
S-15490	24"	26"			79	75	70
S-17091	36"	38"			198	188	175

BOARD NOT INCLUDED

## DOUBLE WING – JUMBO DELUXE

COLOR: White

MODEL NO.	BOX SIZE L x W x H	HEADER SIZE	QTY./ CTN.	PRICE PER BOX	10	50+
S-18212	48"	60"	.090"	5	\$86	\$76
S-18213	60"	80"			107	86
S-18214	72"	96"			133	112

BOARD NOT INCLUDED

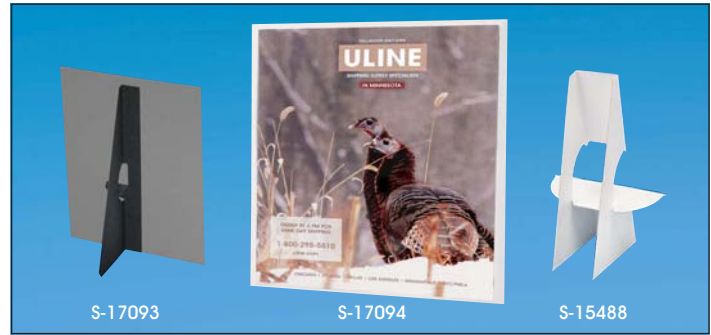

Create an instant display for signs, photos and presentations.

- No glue needed – Adhesive sticks to coated and uncoated paper.
- Double wing provides extra-firm support.
- Use with Foam Core Board (see pages 792-793) or Chipboard Pads (see page 41).

**Jumbo Deluxe** – Huge sizes used for trade shows. Corrugated. Fold in half for storage.



# BALLOT BOXES

## CORRUGATED – 200 LB. TEST

SOLD IN CARTON QUANTITIES

MODEL NO.	BOX SIZE L x W x H	HEADER SIZE	QTY./ CTN.	PRICE PER BALLOT BOX		
				10	20	50+
S-9924	6 x 6 x 6"	6 x 6"	10	\$5.30	\$4.60	\$4.40
S-5188	10 x 10 x 10"	10 x 10"		9.00	8.20	7.70

### PRICE EACH

MODEL NO.	BOX SIZE L x W x H	HEADER SIZE	QTY.	PRICE EACH		
				1	3	5+
S-11327	14 x 14 x 50"	14 1/4 x 10 1/2"	1	\$44	\$43	\$41

## ACRYLIC – CLEAR

\* With lock

MODEL NO.	BOX SIZE L x W x H	HEADER SIZE	QTY.	1	3	5+
S-9925	5 x 5 x 6"	5 x 7"	1	\$44	\$41	\$37
S-16323*	5 x 5 x 6"	5 x 7"		48	46	44
S-11328	10 x 10 x 10"	9 1/2 x 11"		117	113	111
S-13382*	10 x 10 x 10"	9 1/2 x 11"		129	125	123

## ACRYLIC – BLACK

\* With lock

MODEL NO.	BOX SIZE L x W x H	HEADER SIZE	QTY.	1	3	5+
S-16324*	10 x 10 x 10"	9 1/2 x 11"	1	\$144	\$141	\$138

Use for employee suggestions, contests, raffles or elections.

- Each box includes a plain header.

**Black Acrylic** – Maintains privacy.



S-13382 Acrylic with Lock



S-16324 Acrylic with Lock



S-5188 Corrugated

# COUNTER DISPLAYS

Successfully promote your products with these display boxes.

**S-7881** – Holds literature up to 8 1/2 x 11" in slanted tray.

**S-15194** – Securely holds pamphlets, brochures up to 4 x 8 1/2".

## DISPLAYS WITH HEADER

SOLD IN BUNDLE QUANTITIES

MODEL NO.	SIZE W x D x H	FRONT LIP HEIGHT	QTY./ BNDL.	PRICE PER DISPLAY	
				10	20+
S-7881	10 x 6 x 18"	1 1/4"	10	\$6.25	\$5.70
S-7880	16 x 12 x 12"	2"		15.50	13.75

## PAMPHLET HOLDER

MODEL NO.	SIZE W x D x H	FRONT LIP HEIGHT	QTY.	50	100+
S-15194	4 x 2 x 7"	2 5/8"	50	\$.70	\$.65



S-7881

S-7880



S-15194

# PLASTIC CROWD CONTROL



Direct folks at indoor or outdoor events. Economical, lightweight and portable.

- Weatherproof, durable and UV resistant.
- Fill bases with sand or gravel for added stability.
- Flat Base – Standard-duty stanchion. Fill weight: 6.4 lbs.
- Dome Base – Heavy-duty stanchion. Fill weight: 12 lbs.
- Plastic Chain – Easily cut to size.
- S-Hooks – Connect chains together.

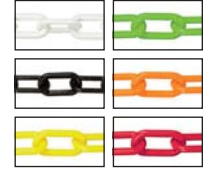

SPECIFY COLOR: White, Black, Yellow, Lime, Orange or Red

MODEL NO.	DESCRIPTION	HT.	POST DIAM.	BASE DIAM.	WT. (LBS.)	PRICE EACH	
						1-2	5+
H-3361	Post with Flat Base	40"	2½"	14"	3	\$37	\$34
H-3362	Post with Dome Base	41"	3"	16"	4	43	40
H-3363	8' Bag of Chain – 2" Links (min. 2 bags)				1	10	8
H-3364	100' Box of Chain – 2" Links				7	80	75
H-5108	500' Box of Chain – 2" Links				33	375	350
S-17974	S-Hooks 12/pk. (min. 2 pks.)				1	6	5



## OUTDOOR CROWD CONTROL

Direct crowds around hazards and work zones. Heavy-duty outdoor portable barrier.

- Durable rubber base tough enough to be driven over.
- Rustproof stainless steel post unscrews from base for easy storage.
- Extra long 2" wide belt reduces number of posts needed.



### YELLOW POSTS

Sold in sets of 2

MODEL NO.	DESCRIPTION	HT.	BELT LENGTH	POST DIAM.	BASE DIAM.	WT. (LBS.)	PRICE/CTN. OF 2	
							1	5+
H-7079	Black/Yellow Belt	40"	16'	3"	19"	43	\$280	\$270
H-7080	"Caution – Do Not Enter" Belt						280	270
H-7864	Black/Yellow Belt	40"	35'	3"	19"	53	395	385
H-7865	"Caution – Do Not Enter" Belt						395	385



## UMBRELLA BAGS

Provide customer convenience and ensure safety.

- Recommended for retail stores and businesses.
- Reduce mop-ups, slippery floors.
- Clear, low density polyethylene.

Stand – Sturdy and wobble-proof.

For more info, see uline.com

### 1 MIL

MODEL NO.	SIZE W x L	BAGS/HEADER	BAGS/CTN.	PRICE PER CARTON		
				1	5	10+
S-17364	7 x 24"	50	1,000	\$73	\$70	\$67
S-17365	7 x 35"			84	81	78
H-2953	46" Bag Stand			138	133	128

## ROLLING CROWD CONTROL

Reposition barriers at crowded airports, museums and stadiums. Rolls easily on recessed wheel.

- 2" wide self-retracting universal belt.
- 16-gauge steel post and cast iron base with 4½" roller.
- Hook up to 3 additional barriers with clips on post.



### ROLLER PRO

MODEL NO.	DESCRIPTION	HT.	BELT LENGTH	POST DIAM.	WT. (LBS.)	PRICE/CTN. OF 2	
						1	5+
H-7879	Black Posts w/ Black Belt	40"	11'	2½"	46	\$223	\$213



# RETRACTABLE CROWD CONTROL

Indoor portable barrier diverts traffic where you need it.

- 2" wide self-retracting universal belt. Connects to all common posts.
- Hook up to 3 additional barriers with clips on post.

**Uline** – 18-gauge steel post with concrete-filled base. Extra-long belt reduces number of posts needed.

**TensabARRIER®** – Virtually indestructible. Sturdy 14-gauge steel post with cast iron base. Wall mount also available.



## ULINE

\* SPECIFY BELT COLOR: Black, Red, Blue or Black/Yellow

MODEL NO.	DESCRIPTION	HT.	BELT LENGTH	WT. (LBS.)	PRICE/CARTON OF 2	
					1	5+
H-3736*	Black Posts with Retractable Belt	40"	10'	42	\$119	\$109
H-4206	Yellow Posts with Black/Yellow Belt		11'	46	149	139
H-5097	Yellow Posts with "Caution - Do Not Enter" Belt					
H-6417	Chrome Posts with Black Belt	40"	10'	42	159	149
PRICE EACH						
H-5098	Wall Mount with Retractable Black Belt	5"	7½'	2	\$60	\$55
H-5872	Wall Mount with "Caution - Do Not Enter" Belt	5½"	15'		90	85
H-5873	Wall Mount with Retractable Black Belt	6½"	30'	3	105	95
H-5099	Wall Mount with Retractable Black/Yellow Belt					
H-7081	Wall Mount with "Caution - Do Not Enter" Belt					

## TENSABARRIER®

\* SPECIFY BELT COLOR: Black, Red or Black/Yellow

MODEL NO.	DESCRIPTION	HT.	BELT LENGTH	WT. (LBS.)	PRICE EACH	
					1	5+
H-1742*	Black Post with Retractable Belt	38"	7½'	22	\$169	\$159
H-4205	Chrome Post with Red Retractable Belt				209	199
H-2468	Chrome Post with Black Retractable Belt				209	199
H-2469*	Wall Mount with Retractable Belt	4½"	7½'	3	105	95
H-3360*	Wall Mount with Retractable Belt	5½"	15'		125	115
H-3735*	Wall Mount with Retractable Belt	7¾"	24'	5	215	205
H-2053	Receiver Post w/o Belt	38"	N/A	21	165	155



# CROWD CONTROL SIGNS



- Attractive black acrylic signs.
- Blank Sign Frame – Insert your own message. Protected by clear acrylic.

Bracket included

MODEL NO.	DESCRIPTION	DIM. W x H	PRICE EACH
H-1743	"Please Enter Here"	7 x 11"	\$85
H-6055	"Line Forms Here"		
H-5095	"Exit - Please Do Not Enter"		
H-5096	Blank Frame	8½ x 11"	98
H-6418		11 x 8½"	

# VELVET ROPE CROWD CONTROL

Adds a red carpet look.

- Recommended for museums, restaurants, theaters and special events.
- Stainless steel posts are 2" thick with heavy 19 lb. base. Won't tip over.
- Premium 2" thick velour rope with matching stainless steel snap ends.



## POSTS

MODEL NO.	HEIGHT	POST DIAMETER	BASE DIAMETER	WT. (LBS.)	PRICE PER CARTON OF 2	
					1	5+
H-4488	38"	2"	14"	39	\$145	\$135

## ROPE

SPECIFY COLOR: Black Red

MODEL NO.	COLOR	LENGTH	WT. (LBS.)	PRICE EACH	
				1	5+
H-4489	Specify	6'	5	\$79	\$73

# DISPLAY TABLES



Easily reach out and touch merchandise you want sold.

- Convenient access from all sides.
- 24, 36 and 48" tabletops are 15" apart.
- Durable, 3/4" thick wood with smooth melamine surface.

- Moves easily on 4 hidden swivel casters: 2 locking.

SPECIFY COLOR: Black or White

MODEL NO.	DESCRIPTION	DIMENSIONS L x W x H	WT. (LBS.)	PRICE EACH	
				1	4+
H-5714	3 Tier Table	48 x 48 x 42"	162	\$495	\$480

SHIPS UNASSEMBLED VIA MOTOR FREIGHT

# WIRE DUMP BINS



Store gym equipment or display bulky retail products and sale items.

- Folds to 3" high for storage when not in use.
- Bottom shelf adjusts every 3".
- Heavy duty, gloss black steel.
- 2" swivel casters: 2 locking.

- Lockable Sports Cart available, see [uline.com](http://uline.com)

MODEL NO.	OUTSIDE DIM. L x W x H	CAPACITY	WT. (LBS.)	PRICE EACH	
				1	5+
H-6266	24 x 24 x 34"	100 lbs.	46	\$130	\$125
H-5109	36 x 36 x 34"	200 lbs.	60	235	225

EASY ASSEMBLY. SHIPS VIA UPS.



# HAT AND COAT HOOK New

Space-saving double hook holds coats, hats or purses.

- Satin finish stainless steel.
- Mounts easily to back of door. Hardware included.



Umbrella Stand, [uline.com](http://uline.com)

MODEL NO.	SIZE W x D x H	COAT CAPACITY	WT. (LBS.)	QTY./CTN.	PRICE PER CARTON	
					1	5+
H-10680	2 x 3 x 6"	2	.5	4	\$140	\$130

# COAT HOOKS



Oversized circular hooks hold jackets.

- Satin finish or black. Easy to assemble.

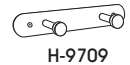

H-9709

SPECIFY COLOR: Silver or Black

MODEL NO.	SIZE W x D x H	COAT CAPACITY	WT. (LBS.)	QTY./CTN.	PRICE PER CARTON	
					1	5+
H-9709	12 x 3 x 2"	2	1	2	\$80	\$70
H-8579	36 x 3 x 2"	6	2	1	95	85

Mounting hardware included

# GONDOLA ACCESSORIES



Peg Hook



Scanner Hook



Price Tag Holder and Insert Cards



Fencing and Dividers



Sign Holder

Create customized product displays for your gondola shelving.

**Peg Hooks** – Hang packaged products and signs.

**Scanner Hooks** – Display price. Flip up for easy stocking.

**Fencing** – Keep merchandise from falling off the shelf.

**Dividers** – Organize small items on shelves.

**Sign Holders** – Display promotions. Grips top of gondola securely.

**Plastic Price Tag Holders** – Clip easily onto shelf channel.

**Insert Cards** – Display prices and barcodes. Perforated.

MODEL NO.	DESCRIPTION	SIZE	QTY./CTN.	PRICE PER CARTON		
				1	3	5+
S-21795	Peg Hooks	2"	25	\$11	\$10	\$9
S-21796		4"		12	11	10
S-21797		6"		13	12	11
S-21798		8"		15	14	13
S-21799		10"		17	16	15
S-21800	Scanner Hooks	6"	25	20	19	18
S-21801	w/ 2 x 1 1/4" Tag Holder	8"		22	21	20

MODEL NO.	DESCRIPTION	SIZE L x H	QTY./CTN.	PRICE PER CARTON		
				1	3	5+
S-21692	Fencing	36 x 3"	10	\$88	\$86	\$84
S-21693		48 x 3"		98	96	94
S-21690	Dividers	11 x 3"	20	75	73	70
S-21691		14 x 3"		81	79	77
S-21802	Sign Holders	6 x 1 1/4"	10	22	21	20
S-20248	Price Tag Holders	47% x 1 1/4"	10	1/\$36	5+/\$34	
S-20247	Price Tag Insert Cards	2 x 1 1/4"	640	1/\$15	5+/\$14	



# GONDOLA SHELVING

Build custom-length store aisles for retail, grocery and hardware stores.

- Simple – Purchase one starter unit and the desired number of add-on units to build each aisle. Built-in grooves to connect multiple units together.
- Steel base with 1/4" thick pegboard panel.
- Assembles in minutes. No tools required.
- Shelves – 500 lb. capacity. Powder-coat finish. Built-in price channel. Sold separately.
- Accessories and price tag holders, see page 206.

## DOUBLE-SIDED STARTER UNITS INCLUDE:

- 2 16" shelves
- 2 upright end trims
- 2 uprights, 1 top rail
- 2 back panels
- 1 center rail
- 1 bottom rail
- 4 base end trims
- 4 base brackets
- 2 base decks
- 2 closed base fronts

### STARTER UNITS

\* SPECIFY COLOR:  Platinum  Black

### SHELVES

Sold in carton quantities

MODEL NO.	STYLE	SIZE W x D x H	BASE SHELF	WT. (LBS.)	PRICE EACH			MODEL NO.	SIZE W x D	QTY./ CTN.	PRICE/SHELF	
					1	3	5+				2	10+
H-3873	Single-Sided	48 x 19 x 54"	16" Deep	70	\$318	\$306	\$294	H-3877*	48 x 16"	2	\$51	\$46
H-3874*		48 x 19 x 72"	87	338	326	314	\$51				\$46	
H-3875*	Double-Sided	48 x 35 x 54"	16" Deep	134	539	523	506	H-3877*	48 x 16"	2	51	46
H-3876		48 x 35 x 72"	156	560	543	528	51				46	

### ADD-ON UNITS

\* SPECIFY COLOR:  Platinum  Black

### SHELVES

Sold in carton quantities

MODEL NO.	STYLE	FOR USE WITH	BASE SHELF	WT. (LBS.)	PRICE EACH			MODEL NO.	SIZE W x D	QTY./ CTN.	PRICE/SHELF	
					1	3	5+				2	10+
H-3873-ADD	Single-Sided	H-3873	16" Deep	50	\$206	\$194	\$182	H-3877*	48 x 16"	2	\$51	\$46
H-3874-ADD*		H-3874	61	228	216	204	\$51				\$46	
H-3875-ADD*	Double-Sided	H-3875	16" Deep	83	303	290	278	H-3877*	48 x 16"	2	51	46
H-3876-ADD		H-3876	100	318	308	294	51				46	

SHIPS UNASSEMBLED VIA MOTOR FREIGHT

## End Cap Unit



## END CAP UNITS

Add merchandising space to aisle ends. Pegboard panels front and back.

### END CAP UNITS

\* SPECIFY COLOR:  Platinum  Black

### SHELVES

Sold in carton quantities

MODEL NO.	STYLE	SIZE W x D x H	BASE SHELF	WT. (LBS.)	PRICE EACH			MODEL NO.	SIZE W x D	QTY./ CTN.	PRICE/SHELF	
					1	3	5+				2	10+
H-4441*	Single-Sided	36 x 19 x 54"	16" Deep	134	\$360	\$348	\$336	H-4443*	36 x 16"	2	\$51	\$46
H-4442		36 x 19 x 72"	171	365	353	341	\$51				\$46	

SHIPS UNASSEMBLED VIA MOTOR FREIGHT



## COAT TREE

Accent your entryway with much-needed coat storage.

- Includes 8 hooks, adjustable height umbrella holder and drip tray.
- Attractive stainless steel with powder-coat finish.
- Weighted 15½" base with protective rubber bottom.
- Easy assembly. Ships via UPS.

MODEL NO.	COLOR	HEIGHT	COAT CAPACITY	WT. (LBS.)	PRICE EACH	
					1	5+
H-7863	Black	73"	8	19	\$155	\$145

## TIERED BASKET STAND

Capture impulse buys at checkout.

- Large, 8" deep wire baskets.
- Position baskets straight or at a 35° tilt.
- Square steel frame. Durable black powder-coat finish.
- Swivel casters for mobility; 2 locking.
- Easy assembly. Ships via UPS.



MODEL NO.	DESCRIPTION	SIZE W x D x H	WT. (LBS.)	PRICE EACH		
				1	3	5+
H-9697	Basket Stand	21 x 16 x 48"	36	\$160	\$155	\$150



# ACRYLIC GRIDWALL ACCESSORIES

Crystal clear, durable acrylic.

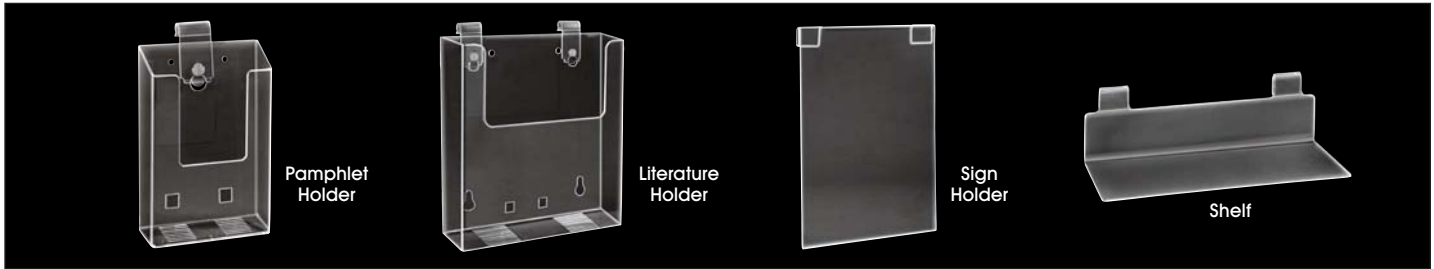

**Brochure and Sign Holders** – Display marketing materials and product information. Pamphlet and Literature Holders include adapter clips.

**Shelf** – Showcase shoes, cosmetics and other products.

Use with Gridwall Panels and Mobile Towers, see page 209.

MODEL NO.	DESCRIPTION	SIZE	QTY./ CTN.	PRICE PER CARTON		
				1	3	5+
S-21367	Pamphlet Holder	4 x 1 1/8 x 6 1/2"	10	\$34	\$32	\$30
S-21368	Literature Holder	9 x 1 3/4 x 9 1/2"		85	83	80

MODEL NO.	DESCRIPTION	SIZE	QTY./ CTN.	PRICE PER CARTON		
				1	3	5+
S-21369	Sign Holder	8 1/2 x 11"	4	\$46	\$44	\$42
S-21370	Shelf	12 x 6"	6	103	100	96



## PIPE WALL UNIT

Trendy warehouse-style piping turns walls into full length merchandising displays.

- Industrial 1 1/4" plumbing pipe in gray finish.
- Includes two 96" slotted wall posts, 48" hangrail and two black melamine shelves with brackets.

MODEL NO.	DESCRIPTION	SIZE H x W x D	QTY./ CTN.	WT. (LBS.)	PRICE EACH	
					1	3+
H-6355	Wall Unit	96 x 48 x 19"	1	78	\$410	\$400

## DUAL BELT CROWD CONTROL

Keep kids in line at the theater and rock stars safe.

- 2" wide self-retracting universal belts.
- Hook up to 3 additional barriers with clips on post.
- 18-gauge steel post with concrete-filled base.



ADA compliant

MODEL NO.	DESCRIPTION	HT.	BELT LENGTH	WT. (LBS.)	PRICE/CTN. OF 2	
					1	2+
H-6454	Black Posts w/ Dual Belt	40"	11'	42	\$199	\$189



## RETAIL PACKING CART

Sort, tag and process garments and online purchases.

- 4 adjustable wire shelves with clear acrylic liners.
- Store hangers on top bar. Bin rail holds tags and markers.
- 5" locking swivel casters.
- Stackable Bins sold separately, see page 491.

EASY ASSEMBLY. SHIPS VIA UPS.

MODEL NO.	DESCRIPTION	DIMENSIONS L x W x H	CAP. (LBS.)	WT. (LBS.)	PRICE EACH	
					1	3+
H-9741	Packing Cart	36 x 24 x 60"	1,000	80	\$350	\$340

## HEAVY DUTY Z-RACK

Super heavy duty with 500 lb. weight capacity.

- Recommended for bulky garments and winter wear.
- Nests to save storage space.
- Large, 4" swivel casters: 2 locking.

EASY ASSEMBLY. SHIPS VIA UPS.

MODEL NO.	DESCRIPTION	HT.	LENGTH	CAP. (LBS.)	WT. (LBS.)	PRICE EACH	
						1	5+
H-8532	Heavy Duty Z-Rack	70"	63"	500	35	\$125	\$110



# GRIDWALL PANELS

Economical wall display for retail stores, tradeshow and fairs.

- Chrome, black or white glossy panels of heavy duty, 1/4" thick wire in 3" square grids.
- Panels can be mounted vertically or horizontally to fit your space.
- Wall Mount Brackets suspend panels 2" from wall. 4 required per panel. Sold separately.

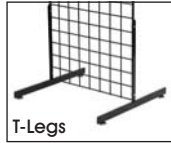

## PANEL BASES

T-Legs – One pair supports one panel.

Gondola Base – Add 4 panels and S-19931 for H-unit style fixture.



## WIRE PANELS

MODEL NO.	DESCRIPTION	SIZE	QTY./CTN.	LBS./CTN.	BLACK OR WHITE			CHROME		
					1	3	5+	1	3	5+
H-4278	3" Standard Grid	2 x 4'	2	24	\$48	\$46	\$43	\$69	\$65	\$63
H-6277		2 x 5'		30	55	53	48	77	75	71
H-4279		2 x 6'		36	62	59	56	89	86	83
■H-5702		2 x 7'		41	72	70	66	104	101	99
■H-4280		2 x 8'		48	83	81	77	118	113	111
S-19930	Wall Mount Bracket		8	3	15	13	12	17	16	15

## PANEL BASES

H-4281	T-Legs	24 x 19 1/2"	4	11	\$44	\$42	\$39	\$49	\$47	\$44
H-4282	Gondola Base	24 x 48"	1	14	49	47	44	58	55	50

## GRIDWALL MOBILE TOWERS

■H-5703	Triangle Tower	2 x 2 x 6 1/2'	1	56	\$156	\$148	\$137	\$201	\$194	\$178
---------	----------------	----------------	---	----	-------	-------	-------	-------	-------	-------

■ SHIPS VIA MOTOR FREIGHT

## GRIDWALL MOBILE TOWERS

Grab attention from every direction with this 3-sided mobile display.

- Durable, glossy 1/4" thick wire in 3" square grids.
- Includes three 2 x 6' panels, connectors and base with 3 locking casters.

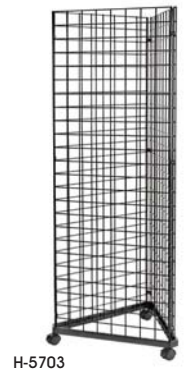

# GRIDWALL ACCESSORIES



Build your own customized gridwall display. More accessories available on [uline.com](http://uline.com)

## METAL ACCESSORIES

SPECIFY COLOR: Black, White or Chrome

MODEL NO.	DESCRIPTION	SIZE	QTY./CTN.	PRICE PER CARTON		
				1	3	5+
S-19932	Peg Hooks	2"	25	\$15	\$14	\$13
S-19933		4"		16	15	14
S-19934		6"		17	16	15
S-19935		8"		19	17	16
S-19936		10"		23	21	20
S-19937		12"		25	24	23
S-19931		Connector Clips		N/A	25	12
S-22263	Scanner Hooks	8"	25	57	54	52

## METAL ACCESSORIES (CONT.)

SPECIFY COLOR: Black, White or Chrome

MODEL NO.	DESCRIPTION	SIZE	QTY./CTN.	PRICE PER CARTON		
				1	3	5+
S-19940	Straight Faceout	12"	12	\$47	\$45	\$41
S-19941	7 Ball Waterfall	16"		54	52	49
S-19942	5 J-Hook Waterfall	16"		66	61	57

## WIRE BASKETS

SPECIFY COLOR: Black, White or Chrome

S-18618	Wire Basket	12 x 12 x 4"	6	\$44	\$42	\$40
S-21145		12 x 12 x 8"		68	66	64
S-18612		24 x 12 x 4"		59	57	55

# SLATWALL ACCESSORIES



Literature Holder

Sign Holder

Pamphlet Holder

## ACRYLIC BROCHURE HOLDERS

MODEL NO.	DESCRIPTION	SIZE	QTY./ CTN.	WT. (LBS.)	PRICE PER CARTON		
					1	2	5+
S-18604	Pamphlets	4 x 1 1/8 x 6 1/2"	10	3	\$32	\$30	\$28
S-18605	Booklets	6 x 1 1/4 x 6 9/16"		5	55	52	50
S-18606	Literature Holder	9 x 1 3/4 x 9 1/2"		10	82	79	77
S-18603	Extra Brochure Holder Clip		10	1	9	8	7

## ACRYLIC SIGN HOLDERS

MODEL NO.	DESCRIPTION	SIZE	QTY./ CTN.	WT. (LBS.)	PRICE PER CARTON		
					1	2	5+
S-18607	Single Sheet	5 x 7"	4	2	\$28	\$26	\$24
S-18601		8 1/2 x 11"		3	38	36	34
S-19988		11 x 8 1/2"		3	38	36	34
S-21705		11 x 17"		6	74	71	68

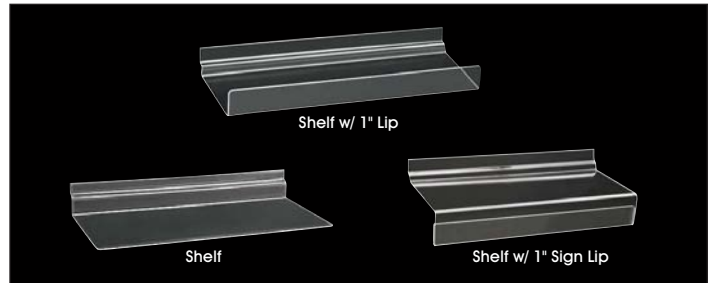

Shelf w/ 1" Lip

Shelf

Shelf w/ 1" Sign Lip

Turn your walls into merchandising display space.

**Brochure and Sign Holders** – Display marketing and product literature.

**Shelves** – Showcase shoes, cosmetics and other products.

## ACRYLIC SHELVES

MODEL NO.	DESCRIPTION	SIZE	QTY./ CTN.	WT. (LBS.)	PRICE PER CARTON		
					1	2	5+
S-18602	Shelf	10 x 4"	6	3	\$37	\$35	\$33
S-18608		12 x 6"		4	47	44	41
S-21706	Shelf w/ 1" Lip	10 x 4"	6	3	39	37	35
S-18609	Shelf w/ 1" Sign Lip			4	41	39	37

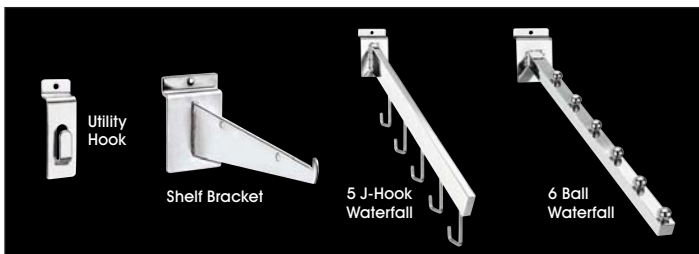

Utility Hook

Shelf Bracket

5 J-Hook Waterfall

6 Ball Waterfall

**Shelf Brackets** – Support glass, wood and melamine shelves for product display.

**Straight and Waterfall** – Hang shirts, sweatshirts and jackets.

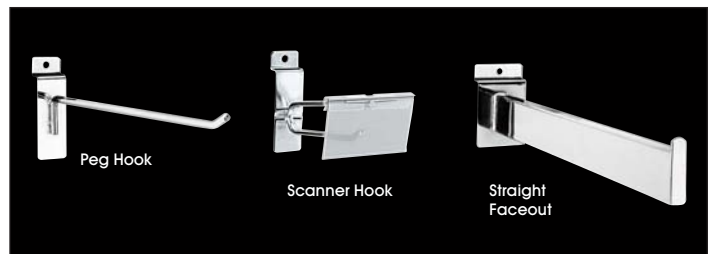

Peg Hook

Scanner Hook

Straight Faceout

**Utility and Peg Hooks** – Hang framed pictures, signage and packaged products.

**Scanner Hooks** – Display price. Flip up for easy stocking.

## METAL ACCESSORIES

SPECIFY COLOR: Chrome or Black

MODEL NO.	DESCRIPTION	SIZE	QTY./ CTN.	WT. (LBS.)	PRICE PER CARTON		
					1	2	5+
S-18613	Utility Hooks	N/A	100	8	\$45	\$43	\$41
S-19200	Shelf Brackets	8"	12	6	29	26	24
S-19201		10"		6	31	29	26
S-21144		12"		7	33	31	29
S-18617	5 J-Hook Waterfall	16"	12	14	57	54	52
S-19989	Scanner Hooks	4"	25	4	39	36	34
S-19990		6"		5	41	39	36
S-19991		8"		6	43	41	39
S-21142		12"		8	51	47	45

## METAL ACCESSORIES

SPECIFY COLOR: Chrome, Black or White

MODEL NO.	DESCRIPTION	SIZE	QTY./ CTN.	WT. (LBS.)	PRICE PER CARTON		
					1	2	5+
S-18611	6 Ball Waterfall	16"	12	12	\$45	\$43	\$41
S-19197	Peg Hooks	2"	25	4	13	12	11
S-19198		4"		4	14	13	12
S-19199		6"		5	15	14	13
S-18614	Peg Hooks	8"	25	5	18	15	14
S-18615		10"		6	20	19	18
S-18616		12"		6	22	21	20
S-18610	Straight Faceout	12"	12	9	42	40	37



## Acrylic J-Shelves

Display books, software and videos.

- Tilted shelf with 2 1/2" front lip.
- Crystal clear, durable acrylic.



## Wire Baskets

Stock with toys and small items.

- Easily attach to slatwall, gridwall and gondola shelving.

SPECIFY COLOR: Chrome, Black or White

MODEL NO.	DESCRIPTION	SIZE W x D x H	QTY./ CTN.	WT. (LBS.)	PRICE PER CARTON		
					1	2	5+
S-22312	Clear J-Shelf	12 x 2 x 3 1/2"	4	5	\$58	\$55	\$52
S-22313		24 x 2 x 3 1/2"		10	69	66	63
S-22905		24 x 4 x 3 1/2"		12	88	85	82

MODEL NO.	DESCRIPTION	SIZE W x D x H	QTY./ CTN.	WT. (LBS.)	PRICE PER CARTON		
					1	2	5+
S-18618	Wire Basket	12 x 12 x 4"	6	11	\$44	\$42	\$40
S-21145		12 x 12 x 8"		14	68	66	64
S-18612		24 x 12 x 4"		16	59	57	55



# SLATWALL PANELS

Turn your walls into merchandising display space.

- Strong 4 x 8' panels of 3/4" Anchor™ Core board.
- 15 channels per board, spaced 3" apart on center.
- 2 x 4' for smaller displays, see page 212.

**Wire Shelves** – Showcase shoes, handbags or this week's hot item.

PANELS		* SPECIFY COLOR: White, Black or Gray					
MODEL NO.	DESCRIPTION	SIZE H x W	QTY./PACK	LBS./PACK	PRICE PER PACK		
					1	3	5+
H-4776	Paint Ready	4 x 8'	2	170	\$240	\$230	\$225
H-4774*	Colored Melamine				255	250	245
H-5060▲	Wood Melamine				260	255	250

▲ Available in Birch or Cherry

SHIPS VIA MOTOR FREIGHT

WIRE SHELVES		SPECIFY COLOR: Black, White or Chrome					
MODEL NO.	DESCRIPTION	SIZE W x D	QTY./CTN.	WT. (LBS.)	PRICE PER CARTON		
					1	2	5+
H-8035	Wire Shelf	12 x 8"	6	8	\$48	\$46	\$44
H-8036		24 x 12"			67	65	63

ANCHOR™ CORE BOARD IS 50% STRONGER THAN STANDARD FIBERBOARD



Available in: Paint Ready, White, Black, Gray, Birch or Cherry

# SLATWALL GONDOLA DISPLAY

The workhorse of retail stores everywhere.

- Four-sided design gets attention from all directions.
- Giant, 51 sq. ft. display area.
- Solid base with hidden 1½" swivel casters.

**Shelves** – 50 lb. capacity. Sold separately.

H-UNIT GONDOLA		SPECIFY COLOR: White or Black				
MODEL NO.	DESCRIPTION	SIZE W x D x H	WT. (LBS.)	PRICE EACH		
				1	3	5+
H-3760	H-Unit Gondola	51 x 24 x 55"	123	\$450	\$440	\$430

SHIPS UNASSEMBLED VIA MOTOR FREIGHT

SHELF		* SPECIFY COLOR: White or Black			
MODEL NO.	DESCRIPTION	SIZE	QTY./CTN.	PRICE PER CARTON	
				1	3+
H-3761*	Shelf	48 x 10"	4	\$95	\$85
S-19201▲	Bracket	10"	12	31	29

3 brackets required per shelf

▲ SPECIFY COLOR: Chrome or Black



**H-UNIT**  
Shown with additional shelves and accessories.

# ACRYLIC SLATWALL BINS



Organize candies, toys and small bulk products.

- Angled opening allows easy access to items.

MODEL NO.	DESCRIPTION	SIZE W x D x H	QTY./CTN.	WT. (LBS.)	PRICE PER CARTON		
					1	2	5+
S-22306	Clear Bin	6 x 7½ x 5½"	10	7	\$78	\$75	\$70
S-20707		6 x 9½ x 5½"	10	8	88	85	80
S-20708		6 x 11½ x 5½"	10	9	100	97	92
S-20709		12 x 9½ x 5½"	5	6	67	64	61
S-22307	Quarter Ball	12 x 7 x 7"	10	9	120	117	112

# SLATWALL ACCESSORIES

More info, see [uline.com](http://uline.com)

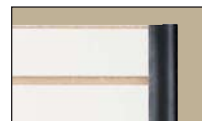

Slatwall Trim



Aluminum Inserts



Light

Put the finishing touches on your slatwall display.

\* SPECIFY COLOR: Black, White or Gray

SHIPS VIA MOTOR FREIGHT

MODEL NO.	DESCRIPTION	LENGTH	QTY./PACK	PRICE PER PACK	
				1	2+
S-23525*	Slatwall Trim Aluminum Inserts	8'	4	\$35	\$34
H-4773			16	260	250

**LIGHT**

ETL/C-ETL Listed

MODEL NO.	LUMENS	NECK LENGTH	CORD LENGTH	WT. (LBS.)	PRICE EACH	
					1	3+
H-7113	200	16"	13'	2	\$77	\$72

## SLATWALL QUARTER PANELS



Display your company's marketing brochures, pamphlets and merchandise.

- Convenient 2 x 4' panels are easy to transport and install.
- Strong 3/4" Anchor™ Core board. Ships via UPS.
- 7 channels per board, spaced 3" apart on center.

Accessories, see page 210 \* SPECIFY COLOR: White, Black or Gray

MODEL NO.	DESCRIPTION	SIZE H x W	QTY./PACK	LBS./PACK	PRICE PER PACK		
					1	3	5+
H-5061	Paint Ready	2 x 4'	2	45	\$100	\$98	\$96
H-5062*	Colored Melamine				108	104	100
H-5063▲	Wood Melamine				110	106	102

▲ Available in Birch or Cherry

## SLATWALL VERTICAL PANELS

Create floor to ceiling shoe, clothing and merchandise displays.

- Recommended for narrow wall spaces, aisle ends, columns and tradeshow booths.
- Strong 8 x 4' panels of 3/4" Anchor™ Core board with white melamine finish.
- 31 channels per board, spaced 3" apart on center.
- Inserts available, see [uline.com](http://uline.com)



MODEL NO.	DESCRIPTION	SIZE H x W	QTY./PACK	LBS./PACK	PRICE PER PACK		
					1	3	5+
H-6351	White Melamine	8 x 4'	2	170	\$265	\$260	\$255

SHIPS VIA MOTOR FREIGHT

## SLATWALL SHELVES



Showcase handbags or this week's hot item.

- Easy to install with shelf brackets, sold separately.

**Anchor™ Core** – 3/4" Anchor™ Core shelves with smooth melamine surface. Finished edges for a clean, crisp look.

**Glass** – Heavy duty 1/4" thick tempered glass. Beveled edges for an elegant presentation. Shelf rests sold separately.



GLASS

**ANCHOR™ CORE SHELVES** ▲ SPECIFY COLOR: White or Black

MODEL NO.	DESCRIPTION	SIZE W x D	CAP. (LBS.)	QTY./CTN.	PRICE PER CARTON	
					1	3
H-6352	Melamine▲	24 x 10"	50	4	\$60	\$55
H-6353		24 x 12"			65	60
H-3761		48 x 10"			95	85
H-6354		48 x 12"			110	100
S-19201	Shelf Brackets*	10"	35	12	31	29
S-21144		12"			33	31

\* SPECIFY COLOR: Chrome or Black

**GLASS SHELVES** \* SPECIFY COLOR: Chrome or Black

MODEL NO.	DESCRIPTION	SIZE W x D	CAP. (LBS.)	QTY./CTN.	PRICE PER CARTON	
					1	3+
H-8516	Glass Shelf	24 x 12"	60	5	\$64	\$58
■ H-8517		48 x 12"			116	105
H-8518	Glass Shelf Rests	1½ x 3/4"	–	50	29	26
S-19201	Shelf Brackets*	10"	35	12	31	29
S-21144		12"			33	31

■ SHIPS VIA MOTOR FREIGHT

## SLATWALL ACCESSORIES

More info, see [uline.com](http://uline.com)



Accent Strips



Hat Display



U Rail

**ACCENT STRIPS** SPECIFY COLOR: Almond, Black, Gray, Red or White

MODEL NO.	DESCRIPTION	SIZE	WT. (LBS.)	PRICE PER ROLL		
				1	2	5+
S-20710	Accent Strips	1½" x 130'	2	\$39	\$36	\$33

**HAT DISPLAY** SPECIFY COLOR: Chrome or Black

MODEL NO.	DESCRIPTION	SIZE	QTY./CTN.	WT. (LBS.)	PRICE PER CARTON		
					1	2	5+
S-21146	Hat Display	8"	12	16	\$45	\$43	\$41

**U RAIL** SPECIFY COLOR: Chrome or Black

MODEL NO.	DESCRIPTION	SIZE	QTY./CTN.	WT. (LBS.)	PRICE PER CARTON
S-21147	U Rail	24 x 10"	6	20	\$81 \$77 \$73



ÉTAGÈRE



LARGE TABLE

MEDIUM TABLE



ISLAND



SINGLE RAIL



DOUBLE RAIL

**TABLES AND SHELVES**

Attractive, high-end displays work in your store or at home.

- Natural distressed pine and steel pipe for a vintage look.

**Tables** – Nest together for layered display or use separately.

**Island** – 3 fixed shelves are 14" apart.

**Étagère** – 3 shelves included, adjust in 7" increments.

MODEL NO.	DESCRIPTION	SIZE W x D x H	SHELF CAPACITY	WT. (LBS.)	PRICE EACH	
					1	3+
H-5523	Medium Table	60 x 30 x 24"		64	\$610	\$560
H-5524	Large Table	72 x 36 x 30"	175 lbs.	92	745	665
H-5525	Island	72 x 26 x 36"		112	1,070	965
H-5526	Étagère	48 x 26 x 84"	225 lbs.	134	1,235	1,125

SHIPS UNASSEMBLED VIA MOTOR FREIGHT

**PIPE CLOTHING RACKS**

Upscale, industrial-style racks inspired by New York's Garment District.

- 1 1/4" plumbing pipe and connectors in gray finish.
- Adjustable height with locking twist knobs.
- 3 3/8" casters, 2 locking.

MODEL NO.	DESCRIPTION	HEIGHT	LENGTH	CAPACITY	WT. (LBS.)	PRICE EACH	
						1	3+
H-5816	Single Rail	44-72"	41"	450 lbs.	37	\$195	\$185
H-6958						240	230
H-5817	Double Rail	50-78"	50"		58	320	310

EASY ASSEMBLY. SHIPS VIA UPS.





# CHROME DISPLAY RACKS



**ROUND** – Circular design maximizes floor space. Holds a ton of clothes.

- Folds for easy storage.
- Adjustable up to 66".
- Melamine topper and casters sold separately.

**STRAIGHT ARM** – Display your merchandise on these easy-to-shop racks.

- **4 Way** – Used for heavier coats and sweatshirts. Optional casters available.

**SLANT ARM** – Waterfall design provides maximum merchandise visibility.

- Adjustable up to 72". 8 ball stops per arm.
- **4 Way** – Levelers included. Optional casters available.

**DOUBLE RAIL** – Twice the display space for hanging garments.

- Sturdy 1" square tubing uprights.
- Adjusts up to 80".
- Hangrails adjust in 3" increments.
- Add-on Hangrail, see [uline.com](http://uline.com)

**SPIRAL** – Stylish design makes shopping easy.

- Spiral arm adjusts up or down.
- Easily holds 28 garments.
- Weighted 18" base won't tip over.

**HAT RACK** – No hat will go unnoticed. Perfect for shops and showrooms.

- Adjustable 4-way tiers.
- 15" weighted square base.
- Removable foam pads on each holder.

**SHOE RACK** – A shoe shopper's dream. Double-sided display for every day or sale events.

- Six shelves per side. Front lip holds shoes in place.
- Folding A-frame design.
- Includes 7 x 11" removable sign. 2 1/4" casters: 2 locking.

\* FITS H-3332, H-3331, H-3787 AND H-3788

EASY ASSEMBLY. SHIPS VIA UPS.

MODEL NO.	DESCRIPTION	HEIGHT	ARM LENGTH	CAPACITY	WT. (LBS.)	PRICE EACH	
						1	5+
■ H-3332	Round	48-66"	36" Diam.	330 lbs.	33	\$120	\$110
H-3333	White Melamine Topper		30" Diam.	30 lbs.	16	43	39
H-3331	4 Way Straight Arm	48-72"	16"	175 lbs.	31	91	83
H-3787	4 Way Slant Arm		18"				
H-3788	Double Rail	48-80"	60"	330 lbs.	42	112	106
H-3789	Spiral	67"	N/A	120 lbs.	19	72	66
H-3791	• Hat Rack	72"	N/A	20 Hats	42	150	140
H-4381	Shoe Rack 62 x 44 x 40" (H x W x D)			168 Shoes	69	265	245
H-3334*	Set of 4 Lockable Casters – 2 1/4" Diameter				2	8	7

• Product slightly different than shown

■ SHIPS VIA MOTOR FREIGHT

# CLOTHES RACKS



Every office, store and home needs one!



**FREE CARTON OF S-13388 HANGERS WHEN YOU BUY 3+ ROLLING RACKS.**  
See [uline.com](http://uline.com) for more information.

## ROLLING

- Set up fast for winter coats and easily collapse for summer storage.
- 48" hangrail expands with two 12" pull-out rods.
- Adjustable height for longer garments.
- H-1977 holds double the amount of garments.

### ROLLING

MODEL NO.	DESCRIPTION	HEIGHT	LENGTH	CAPACITY	WT. (LBS.)	PRICE EACH	
						1	5+
H-1546	Single	55-65"	50"	150 lbs.	28	\$100	\$90
H-1977	Double			200 lbs.	39	140	130

## Z-RACK

- Nests to save storage space.
- H-2493 Add-on Bar for Z-Rack – Doubles capacity.

### Z-RACK AND ACCESSORIES

\* SPECIFY COLOR: Orange or Black

MODEL NO.	DESCRIPTION	HEIGHT	LENGTH	CAPACITY	WT. (LBS.)	PRICE EACH	
						1	5+
H-1978*	Z-Rack	70"	63"	300 lbs.	32	\$90 ea. any qty.	
H-2493	Add-on Bar	N/A	63"	150 lbs.	7	\$19	\$16
H-4277*	Bottom Shelf	N/A	62"		29	62	58
H-4285▲	Cover Supports	4"	24"	N/A	5	22	20

▲Priced per pair

# CLOTHES RACK COVERS

MODEL NO.	DESC.	DIMENSIONS L x H x D	WT. (LBS.)	PRICE EACH		FITS RACK
				1	5+	
S-17933	Clear Vinyl	56 x 60 x 20"	6	\$46	\$42	H-1546
S-17934		66 x 63 x 26"	7	51	46	H-1977/H-1978
S-17935	Blue Nylon	56 x 60 x 20"	3	68	63	H-1546
S-17936		66 x 63 x 26"	4	79	73	H-1977/H-1978

Slip over Uline Rolling and Z-Racks.

- Keep your stored clothes clean and dust free.
- Zippers provide easy access.
- Choose clear vinyl or flexible, tear-resistant blue nylon.



# COAT RACKS

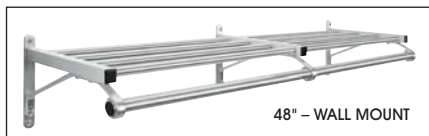

Holds up to 30 coats with shelf for gloves, hats and storage.

- Attractive satin-finish aluminum extends 13" from wall.

MODEL NO.	DESCRIPTION	SIZE	COAT CAP.	WT. (LBS.)	PRICE EACH	
					1	5+
H-2515	Coat Rack	48"	20	6	\$310	\$300
H-9854		72"	30	14	415	400

# WIRE GARMENT RACK

Maximize space with this closet on wheels in your store or office.

- Two 48" shelves hold boxes, hats, shoes and much more.
- Hang bar holds up to 20 jackets.
- 5" locking poly swivel casters.



EASY ASSEMBLY. SHIPS VIA UPS.

MODEL NO.	DESCRIPTION	HT.	LENGTH	CAPACITY	WT. (LBS.)	PRICE EACH	
						1	5+
H-7896	Wire Garment Rack	69"	48"	150 lbs.	50	\$213	\$203

# ZIPPERED GARMENT BAGS



Keep dust, rain and snow off your clothing.

- Full zipper front. Reinforced hanger hole.

**Vinyl** – Long lasting. Clear plastic window allows you to see what is inside.

**Non-Woven Polypropylene** – Breathable storage for seasonal or formal items. Black with clear PVC ID pocket.



BRIDAL GOWN

## 3 MIL VINYL

SPECIFY COLOR: Black, White or Clear

MODEL NO.	SIZE W x D x L	USE	QTY./CTN.	PRICE PER CARTON	
				1	5+
S-14313	24 x 40"	1 Suit	50	\$110	\$103
S-14314	24 x 54"			140	131
S-21655*	24 x 5 x 54"	5 Suits	50	199	188
S-25226*	24 x 5 x 72"	5 Dresses	25	144	135
S-19137	24 x 72"	Bridal Gown	25	103	95
S-14315	36 x 72"		12	61	58

\* Only available in Black or Clear

## 100 GSM NON-WOVEN POLYPROPYLENE

BLACK ONLY

MODEL NO.	SIZE W x L	USE	QTY./CTN.	PRICE PER CARTON	
				1	5+
S-19953	24 x 40"	Suit	50	\$135	\$129
S-19954	24 x 54"	Coat		174	165
S-25227	24 x 72"	Dress	25	159	150

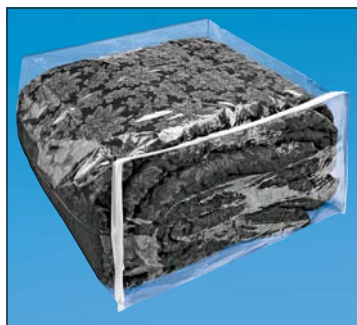

Clearly store and display products while keeping out dust and dirt.

- High-quality vinyl, resists moisture.
- Side and bottom gussets for added room.
- Available with handle, see [uline.com](http://uline.com)

# ZIPPER VINYL BAGS

## 3.2 MIL

MODEL NO.	SIZE W x L x D	USE	QTY./CTN.	PRICE PER CARTON	
				1	5+
S-11511	15 x 18 x 3"	Blanket	144	\$139	\$122
S-16795	15 x 18 x 5"			170	149
S-15400	15 x 18 x 6"			201	177
S-11512	23 x 23 x 12"	Comforter	72	148	132
S-16796	24 x 27 x 8"			151	135



# GARMENT STEAMERS

Smooth and revive dresses, gowns, drapes and tablecloths.

- Auto shutoff for added safety.
- Swivel casters and 5½' flexible hose.

**Jiffy® J-2000** – Heats up in 2 minutes. 1,300 watt heating element.

**Jiffy® J-4000** – All-day use in department stores. 1,500 watt heating element.

UL/C-UL Listed

MODEL NO.	DESCRIPTION	WATER CAPACITY	WT. (LBS.)	PRICE EACH	
				1	2+
H-4473	Professional Duty J-2000	3/4 Gal.	18	\$250	\$240
H-4474	Commercial J-4000	1 Gal.	26	339	325

# LITTLE LAUNDRY CART



Snappy cart used in hotels and laundromats.

- Glides effortlessly between washer and dryer.
- Vinyl-dipped wire with heavy-duty vinyl rim.
- 5" polyurethane swivel casters.

Optional Garment Hanger sold separately

MODEL NO.	DESCRIPTION	OVERALL DIM. L x W x H	PRICE EACH	
			1	3+
H-5238	Laundry Cart	27 x 22 x 27"	\$352	\$341
H-5239	Garment Hanger	53 x 20"	143	138

SHIPS UNASSEMBLED VIA UPS



# HANGERS

COMPLETE LINE, SEE ULINE.COM

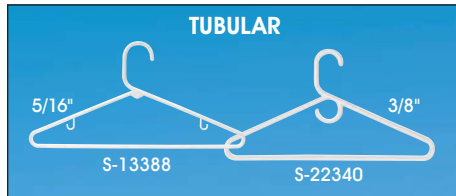

Economical 5/16" plastic.  
Heavy-duty 3/8" hanger with loop.



Molded notches for garment straps.  
Black hangers are GS1 compliant.



Hang clothes with ease from any direction.  
Molded notches for garment straps.



Swivel hook with adjustable padded metal clips – S-20945.

Easy-to-use pinch clip with no-slip grip. GS1 compliant – S-16794.

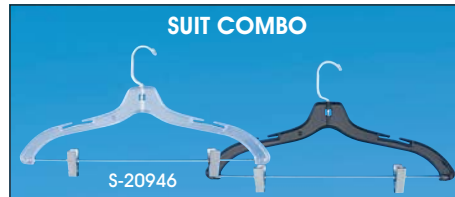

Molded notches keep garments in place.

Adjustable padded metal clips.

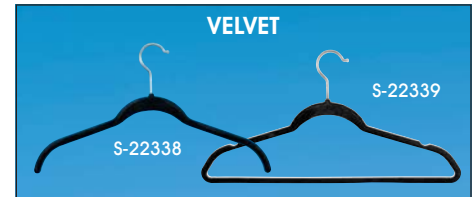

No-slip, flocked velvet finish.  
Blouses and lingerie – S-22338.  
Two-piece outfits and pants – S-22339.

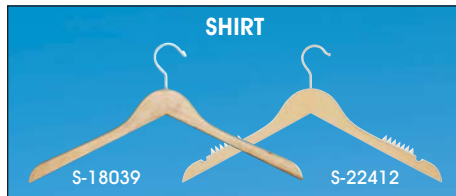

Attractive solid wood hangers.  
Rubber grips and notches for garment straps – S-22412.



Hang suits with locking pants bar – S-18040.  
Adjustable padded metal clips for skirts and pants – S-21710.

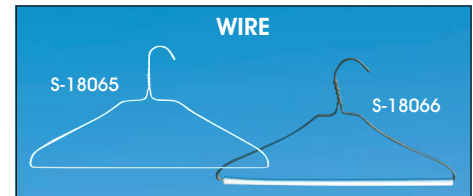

Industry standard shirt hanger – S-18065.  
Strut pants hanger with self-stick cardboard tube – S-18066.

## PLASTIC

\* SPECIFY COLOR: Black or Clear

MODEL NO.	DESCRIPTION	SIZE	COLOR	QTY./CTN.	PRICE/CTN.	
					1	5+
S-13388	Tubular – 5/16"	17"	White	144	\$73	\$70
S-22340	Tubular – 3/8"			120	80	77
S-13389	Fixed Hook	17"	Clear	100	58	56
S-18036			Black	200	84	80
S-18038*	Swivel Hook	17"	Black/Clear	100	62	60
S-20947	Black Swivel Hook		Black w/ Black Hook		64	62
S-20945*	Adjustable Clips	14"	Black/Clear	100	97	95
S-16794*	Pinch Clips	12"		200	124	119
S-20946*	Suit Combo	17"		100	126	123

## VELVET

MODEL NO.	DESCRIPTION	SIZE	COLOR	QTY./CTN.	PRICE/CTN.	
					1	5+
S-22338	Shirt Hanger	17 3/8"	Black	100	\$99	\$94
S-22339	Suit Hanger				109	104

## WOOD

SPECIFY COLOR: Natural, Walnut or Black

MODEL NO.	DESCRIPTION	SIZE	COLOR	QTY./CTN.	PRICE	PRICE
S-18039	Shirt/Coat	17"	Natural/Walnut/Black	50	\$69	\$65
S-22412	Shirt w/ Notches				74	70
S-18040	Suit w/ Bar	14"			92	87
S-21709	Suit Combo				103	99
S-21710	Adjustable Clips				92	87

## WIRE – 14.5 GA

MODEL NO.	DESCRIPTION	SIZE	COLOR	QTY./CTN.	PRICE	PRICE
S-18065	Wire Shirt	18"	White	500	\$90	\$85
S-18066	Strut Pants	16"	N/A		132	127

## HANGER STACKER

Keep checkout areas and stock rooms clutter free.

- Chrome-plated steel.
- Fits plastic, wire and wood hangers.

**FREE UPON REQUEST**  
Free Hanger Stacker w/ \$110+ Hanger order

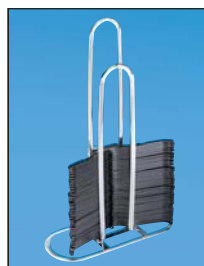

MODEL NO.	DESCRIPTION	SIZE W x D x H	CAPACITY	WT. (LBS.)	PRICE EACH	
					1	5+
H-3564	Hanger Stacker	19 x 7 x 33"	60 - 100	5	\$17	\$15

## MOBILE HANGER RACK

Use at the cash register to neatly organize and store hangers.

- Steel frame with six removable bars.
- 15 slots for custom positioning.
- 3" swivel casters: 2 locking.



MODEL NO.	DESCRIPTION	SIZE W x D x H	CAPACITY	PRICE EACH	
				1	3+
H-7083	Hanger Rack	26 x 18 x 53"	130 - 530	\$150	\$140

## FLAP LOCK BAGS



Easy-to-close fold-over cuff quickly locks in merchandise. No tape needed. 100% virgin polyethylene film.

- Ideal for protecting flatware, food and apparel.

MODEL NO.	SIZE W x L	MIL	APPLICATION	LBS./CTN.	PRICE PER CARTON			QTY./CTN.
					1	5	10+	
S-11535	7 x 7"	1	Large Sandwich	8	\$39	\$36	\$32	2,000
S-10608	9 x 12"	1	Youth T-Shirt	8	32	30	27	1,000
S-10609	12 x 15"		Dress Shirt	13	48	44	42	
S-6649	9 x 12"	2	Youth T-Shirt	17	54	51	49	1,000
S-8528	10 x 15"		Large T-Shirt	22	67	64	62	
S-9859	11 x 14"	2	Portrait	21	70	67	64	1,000
S-8529	12 x 14"		Blouse	25	75	72	70	
S-6650	12 x 16"		Dress Shirt	29	84	80	77	
S-14334	12 x 18"		Light Sweater	31	98	93	90	
S-18051	14 x 16"	2	Sweatshirt	34	104	99	93	1,000
S-6651	14 x 18"		Sweater	37	109	104	98	
S-6652	16 x 20"		Jacket	48	139	134	129	
S-12357*	18 x 24"	2	Blanket	31	91	87	82	500

\*S-12357 has a 3" flap

FDA COMPLIANT

## RESEALABLE BAGS



Quickly package clothing and retail items with self-seal adhesive lip. 100% virgin polyethylene film.

- Peel back release strip and fold lip to seal.

MODEL NO.	SIZE W x L	MIL	LBS./CTN.	PRICE PER CARTON			QTY./CTN.
				1	5	10+	
S-9818	4 x 6"	1.5	3	\$35	\$34	\$33	1,000
S-14476	6 x 9"		7	43	41	38	
S-5066	7 x 10"		8	50	48	45	
S-14477	8 x 10"		9	54	50	48	
S-5067	9 x 12"		12	66	63	59	
S-14478	10 x 12"	1.5	13	70	67	64	1,000
S-11063	10 x 13"		15	75	69	66	
S-5068	10 x 15"		17	83	78	75	
S-12278	11 x 14"		18	80	77	71	
S-11064	12 x 15"		20	98	93	87	
S-5069	12 x 18"	1.5	23	112	106	100	500
S-10612	16 x 20"		17	80	77	71	
S-9819	18 x 24"		25	99	93	87	

COMPLETE LINE, SEE PAGE 119

FDA AND USDA COMPLIANT



## VENT HOLE BAGS

Quickly package and stack your merchandise.

- 1/4" vent hole allows air to escape.
- 100% virgin polyethylene film.

MODEL NO.	SIZE W x L	MIL	LBS./CTN.	PRICE PER CARTON			QTY./CTN.
				1	5	10+	
S-11536	6 x 8"	2	8	\$56	\$52	\$49	1,000
S-7934	9 x 12"		18	98	94	90	
S-24111	10 x 12"		20	114	109	103	
S-7935	12 x 16"		28	150	141	134	
S-7936	15 x 18"		39	195	188	177	
S-11537	16 x 22"		52	226	216	207	

FDA COMPLIANT



## ROUND SIZE DIVIDERS

Organize clothing racks by size.

- Fits 1 1/2" round or 1" square hangrail.

MODEL NO.	SPECIFY MESSAGE	PRICE PER PACK		QTY./PACK
		2	5+	
S-18042	XS, S, M, L, XL, XXL or Blank	\$6	\$5	10
S-21694	0, 2, 4, 6, 8, 10, 12, 14, 16, 18, 20			

MINIMUM ORDER 2

# SUFFOCATION WARNING BAGS

Alert customers to potential child hazards.

- Items easily slip into poly bag.
- Recommended for shirts and toys.
- Message printed in English, Spanish and French.
- Available on a roll, see [uline.com](http://uline.com)

**SHIPS FROM  
13 LOCATIONS**



Warning: Keep this bag away from babies and children. Do not use in cribs, beds, carriages or playpens. The thin film may cling to nose and mouth and prevent breathing.

**Resealable with Vent Hole – Two 1/4" vent holes allow air to escape.**

## OPEN END FDA COMPLIANT

MODEL NO.	SIZE W x L	MIL	LBS./ CTN.	PRICE PER CARTON			QTY./ CTN.
				1	5	10+	
S-22803	6 x 9"	1	4	\$26	\$25	\$23	1,000
S-18056	9 x 12"		8	48	46	43	
S-22807	10 x 12"		8	54	51	47	
S-18057	10 x 15"		11	63	61	57	
S-19133	12 x 15"		13	79	76	71	
S-18058	12 x 18"		15	90	87	81	
S-19134	14 x 20"		18	102	98	91	
S-19135	18 x 24"		29	127	120	114	
S-13125	6 x 9"		2	8	36	33	
S-22804	6 x 12"	10		46	43	41	
S-12358	8 x 10"	11		47	45	42	
S-12359	9 x 12"	14		62	60	57	
S-16787	10 x 15"	20		84	80	76	
S-15380	11 x 14"	21		85	81	77	
S-16788	12 x 15"	24		100	96	90	
S-12360	12 x 18"	29		116	109	104	
S-16789	14 x 20"	37		154	146	139	
S-19952	15 x 18"	36		153	145	138	
S-19136	16 x 16"	35	150	143	135		
S-15381	18 x 24"	2	29	113	108	102	500
S-18059	18 x 30"		34	144	137	129	
S-13126	22 x 24"		37	139	131	125	
S-22811	24 x 36"	2	29	106	100	95	250

## RESEALABLE WITH VENT HOLE FDA COMPLIANT

MODEL NO.	SIZE W x L	MIL	LBS./ CTN.	PRICE PER CARTON			QTY./ CTN.
				1	5	10+	
S-20699	9 x 12"	1.5	12	\$76	\$74	\$70	1,000
S-20700	10 x 15"		16	96	91	87	
S-20701	12 x 18"		23	130	125	118	
S-20702	14 x 20"		29	154	147	139	
S-22809	18 x 24"	1.5	26	136	130	125	500

## RESEALABLE FDA COMPLIANT

MODEL NO.	SIZE W x L	MIL	LBS./ CTN.	PRICE PER CARTON			QTY./ CTN.		
				1	5	10+			
S-21687	4 x 6"	1.5	3	\$38	\$36	\$34	1,000		
S-22301	4 x 10"		5	46	44	42			
S-22302	5 x 7"		4	45	43	41			
S-19948	6 x 6"		5	45	43	41			
S-19949	6 x 9"		6	46	44	42			
S-21688	6 x 12"		8	54	52	49			
S-22805	7 x 10"	1.5	8	56	54	51	1,000		
S-16790	8 x 10"		9	57	55	52			
S-22806	8 x 12"		11	70	67	63			
S-18055	9 x 12"		12	71	69	64			
S-20683	10 x 12"		13	89	83	79			
S-22808	10 x 13"		15	90	84	80			
S-16791	10 x 15"		16	91	85	81			
S-19131	11 x 14"		17	94	90	85			
S-21689	12 x 12"		15	111	106	101			
S-16792	12 x 15"		19	114	109	102			
S-20696	12 x 16"	1.5	20	124	118	111	1,000		
S-16793	12 x 18"		23	126	120	113			
S-22303	14 x 18"		30	145	138	130			
S-19132	14 x 20"		26	149	142	134			
S-22304	16 x 16"		31	182	175	169			
S-19950	16 x 20"		1.5	17	108	101		96	500
S-20697	16 x 24"			20	131	125		119	
S-19951	18 x 24"			23	143	136		128	
S-22810	20 x 20"			21	142	135		127	
S-22305	20 x 24"			29	163	156		149	
S-20698	22 x 24"	27		179	171	162			



## ROUND SIZE LABELS

Separate merchandise by size with these pre-printed labels.

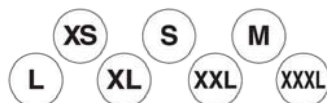

3/4" DIAMETER SPECIFY COLOR: Clear or White

MODEL NO.	SPECIFY MESSAGE	PRICE PER ROLL		QTY./ ROLL
		1	5+	
S-9671	XS, S, M, L, XL, XXL or XXXL	\$6	\$5	1,000

## STRIP LABELS

Can't miss your size in the pile.

- Use with folded apparel.
- Clear adhesive label with black print on white background.



1 1/4 x 5"

MODEL NO.	SPECIFY MESSAGE	PRICE PER ROLL		QTY./ ROLL
		1	5+	
S-18052	XS, S, M, L, XL, XXL or XXXL	\$7	\$6	250



# PLASTIC STORAGE

STERILITE®



S-18822

Amazingly popular! Keep supplies organized and safe from pests and dust. Use in schools, salons and retail stores.

- Durable polypropylene construction.

**Containers** – Protection from dust and moisture. Secure snap-on lid. Stackable, nestable.

**S-21756** – Space-saving design with latching handles. Wheels for easy mobility.



S-21756 with wheels

**3-Drawer Carts** – Keep supplies or crafts organized and mobile. Drawer stops prevent spills. 1 1/4" swivel casters.

## CONTAINERS

MODEL NO.	OUTSIDE DIM. L x W x H	RECOMMENDED USE	QTY./ CTN.	PRICE PER CTN.	
				1	3+
S-18822	23 x 16 x 6"	Cords, Electronics	10	\$131	\$123
S-18824	23 x 16 x 12"	Crafts, Toys	8	128	121
S-25104	30 x 19 x 14"	Bedding, Clothes	4	90	85
S-18823	35 x 16 x 6"	Seasonal Linens	6	109	102
S-21756	34 x 19 x 7"	Gift Wrap	4	94	89



S-18824

## 3-DRAWER CARTS

MODEL NO.	SIZE W x L x H	RECOMMENDED USE	QTY./ CTN.	PRICE PER CTN.	
				1	3+
S-19113	15 x 13 x 24"	Art/Office Supplies	2	\$64	\$61
S-19903	15 x 22 x 24"	Beauty Supplies	1	49	46

SHIPS ASSEMBLED VIA UPS



S-19113

# FOLDING SHOPPING CART



Transport groceries, laundry and sports equipment in apartments and condos.

- Lightweight. Collapses to 6" for easy storage.
- Steel frame with black powder-coat finish. Foam padded handle.
- Two 4" rubber swivel casters, two 6" poly rigid casters.

SHIPS ASSEMBLED VIA UPS

MODEL NO.	OUTSIDE DIM. W x L x H	CAPACITY	WT. (LBS.)	PRICE EACH	
				1	5+
H-9520	15 x 15 x 42"	100 lbs.	16	\$105	\$100

# CONVENIENCE CART

Maneuver in narrow aisles. Steel with powder-coat finish.

- Nestable for space-saving storage.
- 5" polyurethane casters: 2 swivel, 2 rigid.
- More Shopping Carts, see [uline.com](http://uline.com)



Drop ships from TN in 7-10 business days

MODEL NO.	SIZE W x L x H	WT. (LBS.)	QTY./ SKID	PRICE/CART (MIN. 4)	
				4	10+
H-4567	22 x 33 x 41"	45	10	\$215	\$205

# SHOPPING BASKETS

Customer convenience that pays for itself.

**Hand-Held** – Includes 12 plastic baskets, sign and steel stand.

- Durable metal handles with comfort grips.

**Rolling** – Plastic. Convenient 36" telescoping handle and easy-grip carry handle.

- Nestable. 2" casters with 55 lb. capacity.



## HAND-HELD

SPECIFY COLOR: Red or Blue

MODEL NO.	SIZE W x L x H	CAPACITY	QTY./ CTN.	PRICE PER CARTON	
				1	5+
H-7875	12 x 17 x 9"	5 Gallons	12	\$105	\$95

## ROLLING

SPECIFY COLOR: Red or Black

MODEL NO.	SIZE W x L x H	CAPACITY	QTY./ CTN.	PRICE PER CARTON	
				1	5+
H-4204	20 x 15 x 18"	13 Gallons	6	\$195	\$185

# HANG TABS

Easy-to-use precut **clear** tabs turn bags and small boxes into display items.

- Permanent adhesive.
- Simply peel off backing and stick to product.
- Heavy Duty – Fold-over styles hold up to 36 oz.

## ULINE

MODEL NO.	SIZE W x L	HOLE SHAPE	QTY./CTN.	PRICE PER CARTON		
				1	5	10+
S-7643	7/8 x 1 1/8"	J-Hook	500	\$30	\$27	\$25
S-12558*	1 x 1 3/4"		3,500	136	125	115
S-11655	1 1/2 x 1 1/8"		500	22	20	18
S-11656	7/8 x 1 1/4"	Round	500	11	10	9
S-5861	1 x 2"		1,000	36	34	32
S-5863	2 x 2"		500	30	27	25
S-11657	1 1/8 x 1 1/4"	Triangle	500	19	17	15
S-5862	2 x 2"		500	30	27	25
S-11658*	2 1/2 x 1 1/2"		4,500	135	133	130
S-13197*	1 1/8 x 1 3/4"	Euro	3,000	116	111	106
S-11659	2 x 2"		500	22	20	18

## ULINE HEAVY DUTY

MODEL NO.	SIZE W x L	HOLE SHAPE	QTY./CTN.	1	5	10+
S-20023	2 x 5 1/4"	Triangle	500	\$47	\$46	\$44
S-20024*	1 1/8 x 2 3/4"	Euro	4,000	216	212	205

## 3M

MODEL NO.	SIZE W x L	HOLE SHAPE	QTY./CTN.	1	5	10+
S-15411	1 x 1 1/2"	J-Hook	500	\$69	\$67	\$65
S-15412	1 x 2"	Round	1,000	89	87	84
S-15413	2 x 2"		500	70	68	65
S-15414	2 x 2"	Triangle	500	70	68	65



S-12559  
Plastic Display Strip,  
see below

S-Hooks available,  
see uline.com



### J-Hook

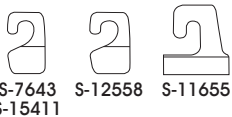

S-7643 S-12558 S-11655

### Round

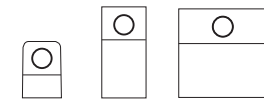

S-11656 S-5861 S-5863 S-15412 S-15413

### Triangle

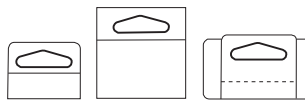

S-11657 S-5862 S-15414 S-11658

### Euro

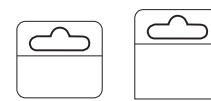

S-13197 S-11659

### Heavy Duty

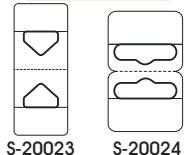

S-20023 S-20024



## INDUSTRIAL DOORSTOPS

Open the door for more customers.

- Rubber. Won't slip or mark floors.

\* SPECIFY COLOR: Brown or Yellow

MODEL NO.	SIZE L x W x H	QTY./PACK	PRICE PER PACK	
			1	5+
H-3050	5 x 2 x 1"	2	\$10	\$9
H-3051*	7 x 4 x 2"		12	11

## DISPLAY STRIPS

Plastic – Use with hang tabs to hold small items.

Metal – Clips hold heavier products. Beige.

MODEL NO.	DESCRIPTION	PRICE PER CTN.		
		1	5	10+
S-12559	21" Plastic – 50 Strips	\$18	\$17	\$15
S-20025	30" Metal – 1 Strip	N/A	7	6

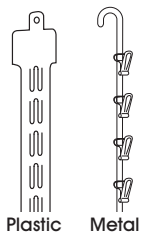

## MERCHANDISE TAGS

Pre-strung tags attach easily to merchandise.

- Smaller sizes for fine jewelry.
- S-11647 for marking rings and necklaces. Adhesive on ends only.



S-11647

S-15421

\* SPECIFY COLOR: White or Magenta String

MODEL NO.	SIZE W x L	QTY./CTN.	PRICE PER CARTON	
			1	5+
S-8574*	3/8 x 13/16" (Jewelry)	1,000	\$17	\$16
S-11647	7/16 x 1 1/8" (Jewelry)		14	13
S-8573	3/4 x 1 1/2" (#2)		14	13
S-7603	1 1/2 x 1 1/4" (#5)		15	14
S-7604	1 1/8 x 2 3/4" (#8)		19	18
S-15421	1 1/8 x 2 3/4" (#8) Sale		20	19
S-13208	1 1/8 x 1 1/4" (#5) Unstrung	1,000	15	14
S-13209	1 1/8 x 2 3/4" (#8) Unstrung		19	18

## RETAIL TAGS



SOLD TAG



HOLD TAG

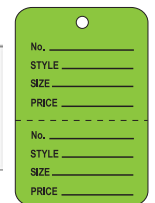

GARMENT TAG

Easily identify merchandise and track sales.

- Slit for quick attachment to hangers or hooks.
- Garment Tag – Perforated. One tag to the customer; one for inventory.

\* SPECIFY COLOR: Green White

MODEL NO.	DESCRIPTION	SIZE W x L	QTY./CTN.	PRICE PER CARTON	
				1	5+
S-10669	Sold Tag	4 1/4 x 2 3/8" (#5)	500	\$24	\$22
S-13210	Hold Tag				
S-10670*	Garment Tag	1 1/4 x 1 1/8"	1,000	11	10
S-10671*		1 3/4 x 2 3/8"		13	12
S-12393	Plain White Tag	1 1/4 x 2 3/8"	1,000	14	13

# PRICE TAG GUN/FASTENERS

Guns listed with corresponding fasteners and needles.

## STANDARD

Fast and easy. Pull the trigger and price tags are attached.

- Loads full strips of plastic fasteners.
- H-863N – Heavy-duty needle with all-steel construction for rugs and mats.



CLIPS OF 50

### STANDARD GUN

MODEL NO.	PRICE EACH	
	1	5+
H-863	\$39	\$36

### STANDARD REPLACEMENT NEEDLES

MODEL NO.	DESCRIPTION	PRICE PER PACK OF 4
H-863B	Standard	\$20
H-863N	Heavy Duty	30

### LONG NEEDLE GUN

MODEL NO.	PRICE EACH	
	1	5+
H-4338	\$56	\$53

### LONG REPLACEMENT NEEDLES

MODEL NO.	DESCRIPTION	PRICE PER PACK OF 4
H-4338N	Long Heavy Duty	\$42

## LONG NEEDLE

60% longer to tag wool, denim or multiple layers of thick fabric. All-steel needle.



### FASTENERS

\* SPECIFY COLOR: Red or Black

MODEL NO.	SIZE	QTY./ CTN.	PRICE PER CARTON	
			1	5+
S-8572	1/2"	5,000	\$13	\$11
S-7105	1"		14	12
S-19965	1" Heavy Duty		21	19
S-7639	2"		14	12
S-7106	3"		15	13
S-12361*	3" Red or Black		21	19
S-19966	1 1/2" C-Hook	5,000	31	28
S-7640	2" C-Hook		32	29

## JUMBO

Save time and money. Attach up to 1,000 tags without reloading.

- Lightweight housing for easy one-handed tagging.
- Special mechanism prevents gun jams.



ROLLS OF 1,000

### GUN

MODEL NO.	PRICE EACH	
	1	5+
H-1120	\$52	\$50

### REPLACEMENT NEEDLES

MODEL NO.	DESCRIPTION	PRICE PER PACK OF 4
H-863B	Standard	\$20
H-863N	Heavy Duty	30

### FASTENERS

MODEL NO.	SIZE	QTY./ CTN.	PRICE PER CARTON	
			1	5+
S-9803	1"	5,000	\$18	\$16
S-13207	1 3/4"			
S-9804	2 1/2"			

## FINE FABRIC

Makes tagging delicate fabrics no problem!

- Reduces risk of damaging silk, linens, lingerie and infant clothing.
- Smaller profile needle and fasteners slide in easily.



CLIPS OF 100

### GUN

MODEL NO.	PRICE EACH	
	1	5+
H-1231	\$39	\$36

### REPLACEMENT NEEDLES

MODEL NO.	DESCRIPTION	PRICE PER PACK OF 4
H-1231B	Fine Fabric	\$20
H-1231N	Heavy Duty	32

### FASTENERS

MODEL NO.	SIZE	QTY./ CTN.	PRICE PER CARTON	
			1	5+
S-10673	3/4"	10,000	\$24	\$22
S-10674	2"		24	22
S-19978	3"		25	23
S-10672	1 1/4" T-End		42	40

## SUCTION CUPS

Hang signs or displays.

- Sticks to smooth, nonporous surfaces like glass, plastic, fiberglass and tile.
- 70% stronger hold with thick ribbed construction.
- Release tab makes removal easy.



MORE SUCTION CUPS, SEE ULINE.COM

### SUCTION CUPS WITH HOOKS

MODEL NO.	HOLDS	DIAMETER	QTY./ PACK	PRICE PER PACK		
				1	3	5+
S-16140	1/2 lb.	3/4"	500	\$102	\$99	\$96
S-16141	1 lb.	1 1/8"	100	33	31	26
S-16142	3 lbs.	1 3/4"	100	40	36	33
S-16143	8 lbs.	2 1/2"	50	43	40	36



# Monarch® LABEL GUNS AND LABELS

Price, date or label incoming inventory and merchandise. • Free ink roller included with each gun and each box of labels.

## MONARCH 1136®

ALPHA/NUMERIC  
TWO LINE GUN

DROP/LOAD  
FEATURE

NEW  
TECHNOLOGY



H-4565

- Print letters and numbers on first line.

PRINTS 2 LINES –  
UP TO 8 CHARACTERS PER LINE:

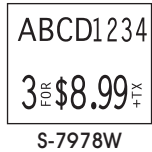

FIRST LINE: A-Z, 0-9.  
SECOND LINE: 0-9, ¢, \$, ., /, FOR, NOW, +TX, -, EACH, OFF, +DEP, LB., SET, CASE, BOX, PKG, PAIR, DOZ, YARD, FOOT.

S-7978W

Corresponding labels shown actual size. Label size: 3/4 x 5/8".



S-15301



S-9654



S-15300

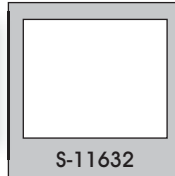

S-11632

Removable Adhesive



S-7978FO

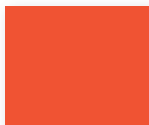

S-7978R



S-7978G



S-7978Y

### GUN

H-4565 GUN	2 lines / 8 characters per line	\$131	3+/\$126 ea.
------------	---------------------------------	-------	--------------

### LABELS

\* Specify color

MODEL NUMBER	QTY./ ROLL	QTY./ BOX	PRICE PER BOX		
			1	5	15+
S-7978* to S-15301	1,750	14,000	\$37	\$35	\$33

## MONARCH 1153®

THREE LINE GUN

DROP/LOAD  
FEATURE

NEW  
TECHNOLOGY



H-1077

- Inventory info easily seen with these large labels.
- Large print on bottom line for easy-to-read prices.

PRINTS 3 LINES –  
UP TO 12 CHARACTERS PER LINE:

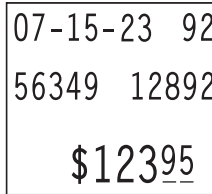

S-9655W

FIRST LINE: 0-9, \$, FOR, ., -, ¢, /, WAS.  
SECOND LINE: 0-9, \$, FOR, ., -, ¢, /, WAS.  
THIRD LINE: 0-9, \$, FOR, /, ., ¢, +TX, +DEP, OFF, LB., SET, CASE, BOX, PKG, PAIR, DOZ, YARD, FOOT, EACH.

Corresponding labels shown actual size. Label size: 1 1/4 x 1".



S-9655R

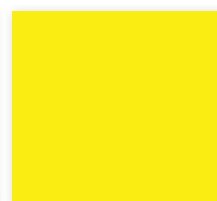

S-9655Y

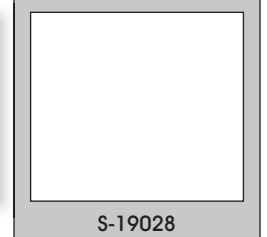

S-19028

Removable Adhesive

### GUN

H-1077 GUN	3 lines / 12 characters per line	\$292	3+/\$279 ea.
------------	----------------------------------	-------	--------------

### LABELS

\* Specify color

MODEL NUMBER	QTY./ ROLL	QTY./ BOX	PRICE PER BOX		
			1	5	15+
S-9655* to S-19028	1,000	6,000	\$35	\$33	\$31

## MONARCH 1131®

DATE/NUMERIC  
ONE LINE GUN

DROP/LOAD  
FEATURE

NEW  
TECHNOLOGY



H-7894

- Prints date and price on the same label.
- Easily identify expiration dates.

PRINTS 1 LINE –  
UP TO 8 CHARACTERS:

ONE LINE: JAN-DEC, AM, PM, 2023-2032,  
0-9, \$, ¢, FOR, /, EACH, OFF, +TX.

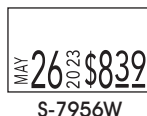

S-7956W

Corresponding labels shown actual size. Label size: 3/4 x 7/16".



S-7956FO



S-7956R



S-7956G



S-7956Y



S-7956BLU

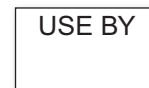

S-10560



S-9653



S-13166

### GUN

H-7894 GUN	1 line / 8 characters per line	\$74	3+/\$70 ea.
------------	--------------------------------	------	-------------

### LABELS

\* Specify color

MODEL NUMBER	QTY./ ROLL	QTY./ BOX	PRICE PER BOX		
			1	5	15+
S-7956* to S-13166	2,500	20,000	\$39	\$37	\$34

# Monarch® LABEL GUNS AND LABELS

**IN STOCK – SHIPS TODAY**

- Guns listed with corresponding labels. (Example: H-707 uses S-5542 labels) • See [uline.com](http://uline.com) or call for exact gun setup.



## MONARCH 1110®

### ONE LINE GUN

- Labels can be used in Monarch 1105 and 1107 guns.

**PRINTS 1 LINE – UP TO 6 CHARACTERS:**

DROP/LOAD FEATURE



## MONARCH 1131®

### ONE LINE GUN

- More labels/roll.
- Our best-selling gun.

**PRINTS 1 LINE – UP TO 8 CHARACTERS:**

3 FOR 99¢  
S-5542W

**ONE LINE:** 0-9, €, \$, FOR, +TX, ., -.

Corresponding labels shown actual size. Label size: 3/4 x 3/8".

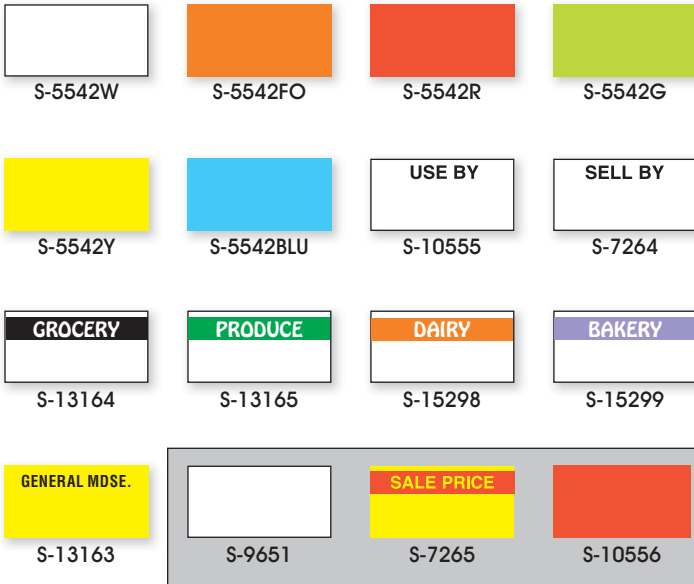

GUN		Removable Adhesive		
H-707 GUN	1 line / 6 characters per line	\$83	3+/\$78 ea.	

LABELS	MODEL NUMBER	QTY./ROLL	QTY./BOX	*Specify color		
				PRICE PER BOX		
				1	5	15+
	S-5542* to S-15299	1,063	17,008	\$29	\$27	\$25

4 FOR \$2.95  
S-7956W

**ONE LINE:** 0-9, €, \$, ., FOR, /, +TX, -, EACH, OFF, +DEP, LB., SET, CASE, BOX, PKG, PAIR, DOZ, YARD, FOOT.

Corresponding labels shown actual size. Label size: 3/4 x 7/16".



GUN		Removable Adhesive		
H-991 GUN	1 line / 8 characters per line	\$74	3+/\$70 ea.	

LABELS	MODEL NUMBER	QTY./ROLL	QTY./BOX	*Specify color		
				PRICE PER BOX		
				1	5	15+
	S-7956* to S-15479	2,500	20,000	\$39	\$37	\$34

DROP/LOAD FEATURE



## MONARCH 1155®

### TWO LINE GUN

- Customized for Uline with alpha characters in the first line.
- Large, easy-to-read type.
- Labels can be used in Monarch 1156 and 1170 guns.

**PRINTS 2 LINES – UP TO 12 CHARACTERS PER LINE:**



S-7985W

**FIRST LINE:** Alpha (A-Z)

**SECOND LINE:** 0-9, €, \$, ., FOR, /, +TX, EACH, OFF, +DEP, LB., SET, CASE, BOX, PKG, PAIR, DOZ, YARD, FOOT.

GUN		Removable Adhesive		
H-993 GUN	2 lines / 12 characters per line	\$260	3+/\$250 ea.	

LABELS (ON FACING PAGE)	MODEL NUMBER	QTY./ROLL	QTY./BOX	*Specify color		
				PRICE PER BOX		
				1	5	15+
	S-7985* to S-17546	1,000	8,000	\$31	\$30	\$29

# Monarch® LABEL GUNS AND LABELS

**QUICK, ACCURATE MARKING**

Price, date or label incoming inventory and merchandise. • Free ink roller included with each gun and each box of labels.

## MONARCH 1136® TWO LINE GUN

- More labels per roll.

**PRINTS 2 LINES –  
UP TO 8 CHARACTERS PER LINE:**



H-992



**FIRST LINE:** 0-9, \$, FOR, ., -, /, WAS, 1/2, EA, OFF, , , +TX.

**SECOND LINE:** 0-9, ¢, \$, ., /, FOR, +TX, -, EACH, OFF, +DEP, LB., SET, CASE, BOX, PKG, PAIR, DOZ, YARD, FOOT.

S-7978W

Corresponding labels shown actual size. Label size: 3/4 x 5/8".

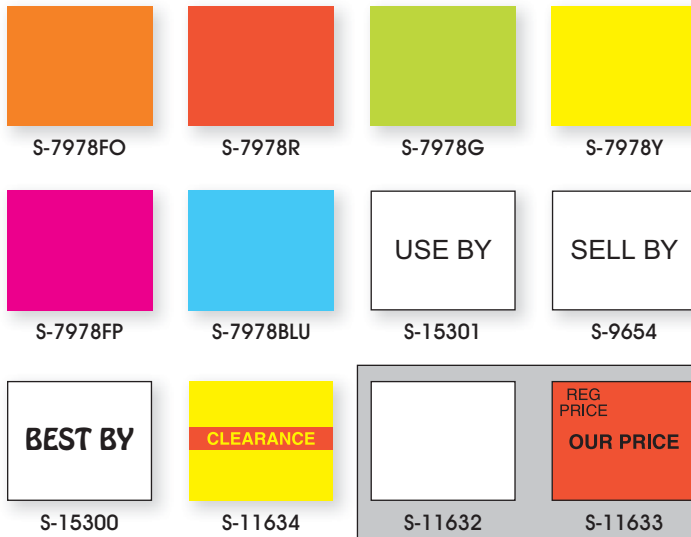

GUN			
H-992 GUN	2 lines / 8 characters per line	\$131	3+/\$126 ea.

MODEL NUMBER	QTY./ ROLL	QTY./ BOX	PRICE PER BOX		
			1	5	15+
S-7978* to S-15301	1,750	14,000	\$37	\$35	\$33

## MONARCH 1115® TWO LINE GUN

- Easy-squeeze trigger.

**PRINTS 2 LINES –  
UP TO 7 CHARACTERS PER LINE:**



H-708

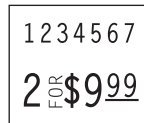

**FIRST LINE:** 0-9, ., -.

**SECOND LINE:** 0-9, +TX, OZ, N/TX, LB., CASE, BOX, PKG, PAIR, DOZ, YARD, FOOT, EACH, FOR, \$, ¢.

S-5543W

Corresponding labels shown actual size. Label size: 3/4 x 5/8".



GUN			
H-708 GUN	2 lines / 7 characters per line	\$145	3+/\$140 ea.

MODEL NUMBER	QTY./ ROLL	QTY./ BOX	PRICE PER BOX		
			1	5	15+
S-5543* to S-15465	1,500	15,000	\$37	\$35	\$33

## MONARCH 1155® LABELS



S-7985FO

S-7985R

S-7985G

S-7985Y

S-7985FP



S-7985BLU

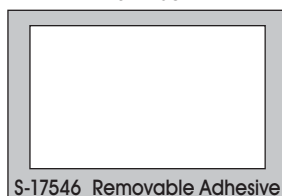

For use with Monarch 1155®

Corresponding labels shown actual size. Label size: 1 1/4 x 3/4".

MODEL NUMBER	QTY./ ROLL	QTY./ BOX	PRICE PER BOX		
			1	5	15+
S-7985* to S-17546	1,000	8,000	\$31	\$30	\$29





**FDA COMPLIANT FOR DIRECT FOOD CONTACT**

## CRYOVAC® CT-300 SERIES

America's best selling polyolefin film.

- Puncture resistance works well with irregularly shaped objects.
- Versatile: can be used with virtually any shrink machine.
- **Pre-perforated** – Tiny vent holes allow air to escape while shrinking. Available in select sizes.

## CRYOVAC® D-940

Shrinks "friendly" – Won't buckle or distort soft and lightweight products.

- Soft yet strong film protects without damaging packaging.

### CRYOVAC® CT-304 – 55 GAUGE CENTERFOLD

MODEL NO.	SUGGESTED USE	WIDTH	FT./ ROLL	LBS./ ROLL	PRICE PER ROLL		
					1	2	4+
S-23559	Gift Baskets	8"	4,770	17	\$276	\$265	\$254
S-23560		10"		21	334	323	312
S-23561		12"		25	414	397	381
S-23562		14"		29	472	455	439
S-23563		Pizzas		16"	34	541	519
S-23564		18"	38	615	587	565	
S-23565		20"	42	679	651	624	

### CRYOVAC® CT-306 – 90 GAUGE CENTERFOLD

MODEL NO.	SUGGESTED USE	WIDTH	FT./ ROLL	LBS./ ROLL	PRICE PER ROLL		
					1	2	4+
S-23574	Plumbing Fixtures	14"	2,910	29	\$451	\$435	\$418
S-23575		16"		34	519	497	475
S-23576		18"		38	582	560	538
S-23577		20"		42	645	623	595

### CRYOVAC® D-940 – 60 GAUGE CENTERFOLD

MODEL NO.	SUGGESTED USE	WIDTH	FT./ ROLL	LBS./ ROLL	PRICE PER ROLL		
					1	2	4+
S-16348	Textiles	10"	4,370	24	\$324	\$312	\$307
S-14001		12"		29	390	378	367
S-14002		14"		33	450	439	428
S-14003		16"		39	511	499	488
S-16349		18"		44	577	560	549

### CRYOVAC® CT-305 – 70 GAUGE CENTERFOLD

MODEL NO.	SUGGESTED USE	WIDTH	FT./ ROLL	LBS./ ROLL	PRICE PER ROLL		
					1	2	4+
S-23566	Auto Parts	8"	3,750	17	\$255	\$244	\$233
S-23567		10"		21	311	300	289
S-23568		12"		25	380	363	341
S-23569*		14"		29	437	420	404
<b>S-23570*</b>		Books		16"	<b>34</b>	<b>\$460 per roll any qty.</b>	
S-23571		18"	38	561	539	517	
S-23572		20"	42	624	596	574	
S-23573		24"	50	748	721	693	

### CRYOVAC® D-940 – 75 GAUGE CENTERFOLD

MODEL NO.	SUGGESTED USE	WIDTH	FT./ ROLL	LBS./ ROLL	PRICE PER ROLL			
					1	2	4+	
S-10458	Stationery	10"	3,500	24	\$302	\$297	\$286	
S-10459		12"		29	361	356	344	
S-10460		14"		33	417	411	400	
S-10461		Software		16"	38	476	464	453
S-10462		18"		44	539	522	511	

\*Specify plain or pre-perforated

## POLYOLEFIN SHRINK BAGS

Strong, puncture-resistant film molds well to any shaped product.

### 100 GAUGE

MODEL NO.	DIMENSIONS W x L	QTY./ CTN.	LBS./ CTN.	PRICE PER CARTON			
				1	2	5	10+
S-16350	4 x 6"	500	1	\$22	\$20	\$19	\$18
S-16351	6 x 7"		1	26	24	23	22
S-16352	6 x 8½"		2	27	25	24	23
S-16353	7 x 10"		2	37	33	31	30
S-16354	8 x 12"		3	46	42	40	37
S-16355	10 x 15"		4	80	75	69	64

- Safe, odorless, noncorrosive. Smokeless sealing.
- Soft film easy on equipment. Keeps sealing wire clean.
- Bundle like items.



## ECONOMY SHRINK FILM

Best value for general purpose shrink applications.

- Puncture resistant, protects against pilfering and tampering.
- Works well on manual and low/medium speed equipment.

## DELUXE POLYOLEFIN SHRINK FILM

Uline's top polyolefin shrink! Compare performance with the best films available.

- High gloss, unparalleled clarity for fantastic appearance.
- Tough, flexible, conforms to unusually shaped or heavy items.
- Puncture and tear resistant, stretches without breaking.



ULINE ECONOMY – 60 GAUGE CENTERFOLD							
MODEL NO.	SUGGESTED USE	WIDTH	FT./ROLL	LBS./ROLL	PRICE PER ROLL		
					1	2	4+
S-16362		8"		18	\$82	\$75	\$68
S-14989		10"		23	101	93	86
S-14990	Food	12"	4,375	28	120	110	102
S-14991		14"		32	139	128	118
S-14992	Gift Baskets	16"		37	\$134 per roll any qty.		
S-14993		18"		42	177	165	150
S-14994		20"		47	197	182	167
S-17837		24"		49	234	218	203

ULINE DELUXE – 60 GAUGE CENTERFOLD							
MODEL NO.	SUGGESTED USE	WIDTH	FT./ROLL	LBS./ROLL	PRICE PER ROLL		
					1	2	4+
S-16356		8"		18	\$124	\$113	\$108
S-14977		10"		23	147	134	127
S-14978	Food, Medicine	12"	4,375	28	180	165	152
S-14979		14"		32	201	185	174
S-14980	Lightweight Products	16"		37	\$192 per roll any qty.		
S-14981		18"		42	246	224	214
S-14982		20"		47	269	246	236
S-17839		24"		49	322	293	281

ULINE ECONOMY – 75 GAUGE CENTERFOLD							
MODEL NO.	SUGGESTED USE	WIDTH	FT./ROLL	LBS./ROLL	PRICE PER ROLL		
					1	2	4+
S-16363		8"		18	\$82	\$75	\$68
S-14995		10"		23	101	93	86
S-14996		12"		28	120	110	102
S-14997	Toys	14"	3,500	32	139	128	118
S-14998		16"			37	\$134 per roll any qty.	
S-14999	Books	18"		42	177	165	150
S-15000		20"		47	197	182	167
S-16364		24"		54	234	218	203
S-17838		30"		62	295	272	250

ULINE DELUXE – 75 GAUGE CENTERFOLD							
MODEL NO.	SUGGESTED USE	WIDTH	FT./ROLL	LBS./ROLL	PRICE PER ROLL		
					1	2	4+
S-16357		8"		18	\$120	\$112	\$104
S-14983		10"		23	143	124	119
S-14984		12"		28	165	147	142
S-14985	Software	14"	3,500	32	188	171	164
S-14986		16"			37	\$185 per roll any qty.	
S-14987	DVDs, CDs	18"		42	233	214	207
S-14988		20"		47	255	237	228
S-16358		24"		54	300	284	267
S-17840		30"		62	377	355	334

ULINE ECONOMY – 100 GAUGE CENTERFOLD							
MODEL NO.	SUGGESTED USE	WIDTH	FT./ROLL	LBS./ROLL	PRICE PER ROLL		
					1	2	4+
S-16365	Office Products	14"	2,620	32	\$139	\$128	\$118
S-16366		16"		37	158	145	133
S-16367		18"		42	177	165	150

ULINE DELUXE – 100 GAUGE CENTERFOLD							
MODEL NO.	SUGGESTED USE	WIDTH	FT./ROLL	LBS./ROLL	PRICE PER ROLL		
					1	2	4+
S-16359	Heavy Items	14"	2,620	32	\$200	\$183	\$172
S-16360		16"		37	222	203	191
S-16361		18"		42	245	223	213

## BLACK SHRINK FILM



Conceal special interest shipments, medical products and health supplements.

- Opaque film conceals product and deters theft.
- Strong, cross-linked polyolefin film.
- Puncture and tear resistant.

200 GAUGE CENTERFOLD							
MODEL NO.	SUGGESTED USE	WIDTH	FT./ROLL	LBS./ROLL	PRICE PER ROLL		
					1	2	4+
S-23621	Software, Books, Media	14"	1,313	32	\$425	\$415	\$405
S-23622		16"		37	485	475	465
S-23623		18"		42	550	535	520

# REYNOLDS PVC SHRINK FILM



Reynolds PVC film has excellent clarity and sparkle.

- Designed for portable or automatic systems.
- Perforated shrink film available. Call for quote.

## 75 GAUGE CENTERFOLD

MODEL NO.	WIDTH	FT./ ROLL	LBS./ ROLL	PRICE PER ROLL			
				1	2	4	6+
S-676	12"	2,000	23	\$167	\$161	\$154	\$147
S-669	14"		27	197	191	182	174
S-572	16"		31	226	217	207	197
S-562	18"		33	254	244	233	222

## 100 GAUGE CENTERFOLD

MODEL NO.	WIDTH	FT./ ROLL	LBS./ ROLL	1	2	4	6+
S-1392	16"	1,500	31	\$239	\$229	\$220	\$211
S-1393	18"		33	265	254	244	232
S-2497	20"		35	289	277	265	254
S-1395	24"		40	348	335	322	305

# HEAVY DUTY SHRINK BUNDLING FILM



Up to 3 times stronger than standard shrink film.

- Bundle or bulk pack items such as cases of soda, water bottles or cleaning supplies.
- Use where toughness and puncture resistance are important.
- Widely used with automated packaging equipment with integral heat tunnels.

## 200 GAUGE SINGLE WOUND

MODEL NO.	WIDTH	FT./ ROLL	LBS./ ROLL	PRICE PER ROLL		
				1	2	3+
S-11519	16"	4,200	54	\$195	\$180	\$171
S-17659	18"		60	215	200	190
■S-11520	20"		68	238	220	210
■S-17660	22"		74	258	242	231
■S-11521	24"		81	278	263	251

■ SHIPS VIA MOTOR FREIGHT

# SHRINK BANDS

IN STOCK - SHIPS TODAY



TO ORDER: Measure the diameter of the widest part of your container to be covered.

Create quick, tamper-evident packaging for bottles and jars.

- Seal spice and sauce jars, water bottles, pharmaceuticals and more.
- 200 gauge PVC.



## 1" BAND HEIGHT - SAFETY

MODEL NO.	FLAT BAND DIM. (mm)	FITS BOTTLE CAP DIAMETER	NON-PERFORATED PRICE PER 1,000		
			1	2	3+
S-16283	48 x 28	3/4 - 1"	\$19	\$18	\$17
S-16284	66 x 28	1 1/4 - 1 1/2"	20	19	18
S-16285	75 x 28	1 1/2 - 1 3/4"			
S-16286	86 x 28	1 3/4 - 2"			

## 1" BAND HEIGHT - CLEAR

MODEL NO.	FLAT BAND DIM. (mm)	FITS BOTTLE CAP DIAMETER	PERFORATED PRICE PER 1,000		
			1	2	3+
S-12227	48 x 28	3/4 - 1"	\$16	\$15	\$14
S-12228	55 x 28	1 - 1 1/4"			
S-12229	66 x 28	1 1/4 - 1 1/2"	17	16	15
S-12230	75 x 28	1 1/2 - 1 3/4"			
S-12231	86 x 28	1 3/4 - 2"			
S-12232	100 x 28	2 - 2 1/2"	19	18	17
S-12233	110 x 28	2 1/2 - 2 3/4"			
S-12234	125 x 28	2 3/4 - 3"			

## 2" BAND HEIGHT - CLEAR

MODEL NO.	FLAT BAND DIM. (mm)	FITS BOTTLE CAP DIAMETER	PERFORATED PRICE PER 1,000		
			1	2	3+
S-18600	48 x 56	3/4 - 1"	\$19	\$18	\$17
S-18623	55 x 56	1 - 1 1/4"			
S-18624	66 x 56	1 1/4 - 1 1/2"	23	22	21
S-18625	75 x 56	1 1/2 - 1 3/4"			
S-18626	86 x 56	1 3/4 - 2"			
S-18627	100 x 56	2 - 2 1/2"	27	26	25
S-18628	110 x 56	2 1/2 - 2 3/4"			
S-18629	125 x 56	2 3/4 - 3"			



# ULINE SHRINK TUBING

PVC tubing is sealed on both sides to speed your packaging.

- Clear, high-gloss packaging.

**200 Gauge Tubing** – Use 2 and 3" widths to create tamper-evident packaging for bottled goods like vitamins and spices.



## 100 GAUGE TUBING

SOLD IN CARTON QUANTITIES

MODEL NO.	WIDTH	FT./ROLL	LBS./ROLL	PRICE PER ROLL		
				1	2	6+
S-6636*	4"	1,500	8	N/A	\$45	\$41
S-7312*	5"		N/A	55	51	
S-6637	6"		13	\$60	57	55
S-5027	8"		16	86	82	78
S-5028	10"		20	110	106	99
S-5868	12"		24	132	128	122
S-5869	14"		28	154	150	140
S-5029	16"		32	177	168	157
S-5030	18"		36	198	190	177
S-5870	20"		40	220	200	190
S-10413	24"		48	264	255	241
S-16279	30"		58	332	320	304

\* 2 rolls/carton

## 200 GAUGE TUBING

SOLD IN CARTON QUANTITIES

MODEL NO.	WIDTH	FT./ROLL	LBS./ROLL	PRICE PER ROLL		
				1	2	6+
S-23533*	1½"	750	3	N/A	\$18	\$16
S-11801*	2"		4	N/A	19	17
S-19011*	2½"		5	N/A	24	22
S-11802*	3"		6	N/A	28	26
S-11531*	4"		7	N/A	37	34
S-19012*	5"		9	N/A	49	45
S-11532	6"		11	\$59	53	50
S-11533	8"		16	79	72	68
S-12998	10"		19	99	93	83
S-15284	12"		23	118	111	102
S-15285	16"		29	150	142	134
S-19013	20"		35	191	183	172

\* 2 rolls/carton

# SEXY ZEBRA KNIFE

Free upon request with any Uline order of \$300 or more.

Comfortable rubber grip. Metal body.

- Includes ratchet lock. 6½" in length.
- 48 snap-off blades. 6 sheets of 8.



Auto-loading snap blades

MODEL NO.	PRICE EACH	EXTRA BLADES	
		MODEL	PRICE/10 SHTS.
H-4342	\$10	H-273B	\$5

# ULINE PVC SHRINK FILM

Uline PVC Film offers a value alternative.

- Designed for portable or automatic systems.
- Shrinks at lower temperatures to speed production.



## 60 GAUGE CENTERFOLD

MODEL NO.	WIDTH	FT./ROLL	LBS./ROLL	PRICE PER ROLL			
				1	2	4	6+
S-16280	8"	2,500	17	\$104	\$95	\$86	\$80
S-7754	10"		21	113	107	96	88
S-7729	12"		22	129	122	111	106
S-7730	14"		27	146	136	123	114
S-7731	16"		31	166	156	142	129
S-7732	18"		33	185	172	158	147
S-16281	24"		49	246	232	213	198

## 75 GAUGE CENTERFOLD

MODEL NO.	WIDTH	FT./ROLL	LBS./ROLL	PRICE PER ROLL			
				1	2	4	6+
S-7755	10"	500	5	\$31	\$29	\$28	\$26
S-2472	12"		6	36	35	33	31
S-2473	14"		8	41	39	37	35
S-2474	16"		10	49	47	43	39
S-3046	18"		12	53	50	47	43
S-7489	24"		16	69	64	59	53
S-11529	6"	2,000	10	57	52	48	43
S-10410	8"		15	75	70	64	58
S-7756	10"		19	90	85	78	71
S-6573	12"		23	107	98	90	83
S-6574	14"		27	128	119	109	99
S-6575	16"		31	\$108 per roll any quantity			
S-6576	18"		36	155	144	128	118
S-11530	20"		40	171	161	146	135
S-6577	24"		47	198	185	172	157
S-17662	26"		50	226	209	194	179
S-17663	30"	56	265	246	229	210	
S-10414	36"	60	301	276	258	239	

## 100 GAUGE CENTERFOLD

MODEL NO.	WIDTH	FT./ROLL	LBS./ROLL	PRICE PER ROLL			
				1	2	4	6+
S-7757	10"	1,500	19	\$96	\$89	\$83	\$77
S-7733	12"		23	113	107	96	88
S-7734	14"		27	133	123	112	105
S-7735	16"		31	152	143	128	118
S-7736	18"		33	165	153	138	126
S-16282	24"		49	210	198	181	169

# HEAT GUNS



## INDUSTRIAL

Variable control easily adjusts heat level.

- 2-speed fan.
- ETL/C-ETL Listed.

MODEL NO.	DESCRIPTION	TEMPERATURE RANGE	WEIGHT	PRICE EACH
H-915	Industrial Heat Gun	110° to 930°F	2 lbs.	\$60



## DELUXE

Shrinks faster, more powerful fan.

- Insulated heating element lasts longer.
- UL/C-UL Listed.

**1 YEAR WARRANTY**

MODEL NO.	DESCRIPTION	TEMPERATURE	WEIGHT	PRICE EACH
H-8094	Deluxe Heat Gun	1,200°F	5 lbs.	\$190

# SHRINK WRAP SYSTEMS

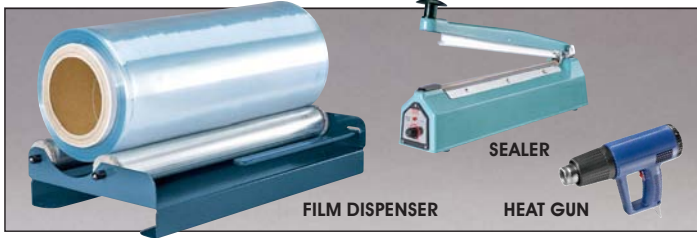

## ECONOMY

All you need to start shrink packaging your products.

- Handles 1-2 packages per minute.
- Use with shrink bags, tubing or film.

System includes: Dispenser, Bar Sealer with or without cutter and H-915 Heat Gun.

Service Kit includes: 2 Heating Elements, 2 PTFE Strips, 2 PTFE Covers.

### ECONOMY SYSTEMS

MODEL NO.	DESCRIPTION	PRICE EACH
H-1164	12" without cutter	\$190
H-5106	12" with cutter	225
H-1165	20" without cutter	275
H-5107	20" with cutter	300

### CORRESPONDING SERVICE KITS

MODEL NO.	SIZE	PRICE EACH
H-191	12"	\$22
H-294*		25
H-1042	20"	31
H-1253*		35

\*Also includes 1 blade



## INDUSTRIAL

Compact, all-in-one design dispenses, seals and trims film.

- Handles 1-2 packages per minute.
- Heavy-duty steel construction. UL/C-UL Listed.

System includes: Bar Sealer, 100 ft. of 75 gauge PVC Film. Optional H-915 Heat Gun.

Service Kit includes: 5 PTFE Tapes, 3 PTFE Covers, 1 Sealing Wire, 1 Microswitch, 1 Reversible Silicone Pad.

### INDUSTRIAL SYSTEMS

MODEL NO.	SIZE	WITHOUT GUN	WITH GUN
H-8254	13"	\$360	\$415
H-8255	18"	415	470
H-8256	24"	475	530
H-8257	40"	515	570

### SERVICE KITS

MODEL NO.	SIZE	PRICE EACH
H-8271	13"	\$46
H-8272	18"	53
H-8273	24"	61
H-8274	40"	79

# DELUXE L-BAR SEALER

Extremely fast for higher volume. Cuts sealing time in half.

- 1000W power seals 6-8 pkgs./min.
- Works with heat gun or shrink tunnel.
- Seals and trims up to two 18" sides at once.

Includes: 18" film dispenser, film separator, worktable and twin perforating hole punches.



UP TO 1,000 PACKAGES PER DAY

MODEL NO.	MAXIMUM SEAL LENGTH	MAXIMUM SEAL THICKNESS	WATTS	WEIGHT	PRICE EACH
H-2378	18 x 18"	100 Gauge	1,000	106 lbs.	\$1,050

SHIPS VIA MOTOR FREIGHT

### SERVICE KIT

S-15286	2 PTFE Tapes, 2 PTFE Covers, 1 Sealing Wire	\$42
---------	---	------

# SHRINK TUNNEL

Superior Italian design is almost maintenance free. Quickly shrink-wrap packages.

- For packages up to 5" high and 15" wide.

- Use with PVC or polyolefin film.
- Seal with Uline Shrink Wrap Systems.

For more information, see [uline.com](http://uline.com)

MODEL NO.	OPENING DIM. H x W	TEMPERATURE RANGE	VOLTAGE	WEIGHT	PRICE EACH
H-951	6 x 16"	100° to 350°F	110V	300 lbs.	\$3,000
H-953	Leg Kit \$460 each				



ALL-DAY USE

# ULINE PVC SHRINK FILM BAGS



MODEL NO.	SIZE W x L	APPLICATION	GA.	QTY./ CTN.	WT. (LBS.)	PRICE PER CARTON			
						1	2	5	10+
S-6833	4 x 6"	Candles, Trading Cards	100	500	2	\$21	\$19	\$18	\$17
S-10412	5 x 8"	Jewelry Box, Pen Set	100	500	2	25	23	22	21
S-3549	6 x 6"	Stationery	100	500	2	24	22	20	19
S-11522	6 x 7"	1 CD Case	80	500	2	20	19	18	17
S-8477	6 x 7"	1 CD Case	100	500	2	25	23	22	20
S-11523	6 x 8½"	1 DVD Case, 1-2 CD Cases	80	500	2	25	23	22	20
S-7727	6 x 8½"	1 DVD Case, 1-2 CD Cases	100	500	2	26	24	23	22
S-1530	6 x 11"	Notepads, Candles	80	500	3	28	26	25	24
S-7728	6 x 11"	Notepads, Candles	100	500	4	31	29	28	27
S-6834	7 x 10"	1-2 DVD Cases, 3-5 CD Cases	100	500	4	34	31	29	28
S-1531	8 x 12"	Invitations, Books	80	500	5	44	40	37	35
S-3550	8 x 14"	Computer Software	100	500	6	48	44	41	38
S-6835	8 x 16"	Awards, Plaques	100	500	7	59	55	51	47
S-3363	9 x 12"	3-5 DVD Cases, Booklets	100	500	6	51	47	43	40
S-1532	9 x 14"	Video, Magazine, Literature	80	500	6	55	51	47	44
S-3364	10 x 15"	Brochures, Catalogs	100	500	8	76	71	66	60
S-3551	12 x 10"	Photographs	100	500	6	53	48	45	43
S-3861	12 x 12"	Frames, Photo Albums	100	500	7	73	68	62	58
S-1533	12 x 16"	Tabloids, Mailers, Reports	80	250	5	56	52	48	45
S-11524	12 x 16"	Tabloids, Mailers, Reports	100	250	5	59	55	52	48
S-2499	12 x 18"	Legal Size, Calendars	100	250	6	68	61	57	54
S-5026	14 x 18"	Computer Reports	100	250	6	79	73	68	62
S-2500	14 x 20"	Oversize Documents	100	250	7	89	83	78	72
S-17661	16 x 20"	Board Games	100	250	8	102	96	88	82
S-3862	18 x 24"	Reams of Paper	100	300	13	157	146	137	126
S-16229	24 x 24"	Poster Frames	100	250	15	194	182	168	158

PVC film shrinks to fit. Speed your packaging operations with these bags.

- Recommended for DVDs, compact discs and software.
- Crystal clear packaging in seconds.
- Dome shrink bags designed for gift or food baskets.



1. Place in bag and seal.

2. Shrink with heat gun.

## DOME SHRINK BAGS

FDA COMPLIANT

MODEL NO.	SIZE W x H	FITS BASKET UP TO		GA.	QTY./ CTN.	WT. (LBS.)	PRICE PER CARTON			
		DIAMETER	HEIGHT				1	2	5	10+
S-11525	16 x 16"	9"	16"	100	100	4	\$28	\$27	\$26	\$24
S-11526	22 x 22"	13"	22"	100	100	5	61	58	55	52
S-3041	23 x 19"	14"	19"	100	100	5	61	58	55	52
S-11527	24 x 24"	14"	24"	100	100	6	68	64	60	58
S-16230	24 x 30"	14"	30"	100	100	7	76	73	70	66
S-11528	26 x 28"	16"	28"	100	100	7	84	80	76	73
S-3042	29 x 24"	20"	24"	100	100	7	75	71	67	62
S-3043	29 x 34"	20"	34"	100	50	5	43	41	37	34





# SHRINK PALLET BAGS



Recommended for large machinery, heavy irregular loads and outdoor protection.

- Heavy-duty moisture and dirt protection.
- Perforated rolls for easy tear-off.
- Slip gusseted bag over pallet and heat shrink.
- White Bags with UVI additive protect from the sun's rays up to 1 year.



## CLEAR

MODEL NO.	FITS PALLET L x W	BAG SIZE W x L x H	MIL	BAGS/ROLL	LBS./ROLL	PRICE PER ROLL		
						1	2	5+
S-15001	42 x 42"	44 x 44 x 66"	4	30	47	\$149	\$142	\$132
S-15002		44 x 44 x 84"			59	194	185	175
S-7772	48 x 40"	50 x 42 x 66"	4	30	50	153	147	137
S-7773		50 x 42 x 78"			60	183	174	160
S-7774		50 x 48 x 84"			68	210	198	185
S-11509	48 x 40"	50 x 42 x 66"	6	20	45	153	147	137
S-7775		50 x 48 x 84"			68	210	198	185
■S-15003		50 x 48 x 96"			75	241	222	214
■S-11510		50 x 48 x 110"			87	271	256	241

## WHITE

■ SHIPS VIA MOTOR FREIGHT

S-18240	48 x 40"	50 x 42 x 66"	4	30	50	\$175	\$169	\$157
S-18241		50 x 48 x 84"			68	240	223	211

# SHRINKFAST™ HEAT GUNS



H-950



H-2030

Easily shrink film on skids and machinery.

- 90° rotating heat guard nozzle, double trigger and automatic shutoff.
- **Propane powered.** • Portable – Use indoors or out.
- Includes 25' hose, pressure gauge, UL guard, wrench and plastic carrying case.
- **Heat Gun H-950** – Up to 18" in a single pass. Adjustable heat settings. Powerful but lightweight.
- **Heat Gun H-2030** – Covers up to 14" in a single pass. Tough aluminum body. Well-proven durability.
- 4' extensions for hard-to-reach areas. 6' extensions, see uline.com

## 4' EXTENSIONS

MODEL NO.	DESC.	HEAT CAPACITY (BTU)	WT.	PRICE EACH	MODEL NO.	USE WITH	WT.	PRICE EACH
H-950	#998	136,000 - 212,000	2 lbs.	\$715	H-1302	H-950	6 lbs.	\$475
H-2030	#975	125,000	3 lbs.	750	H-2031	H-2030	9 lbs.	

# RIPACK® HEAT GUN



Wrap your boat and equipment 15% faster.

- **360° rotatable nozzle** stays cool to the touch.
- Covers up to **19"** in a single pass.
- **Propane powered** with adjustable heat settings.
- Includes 26' hose, fail-safe regulator, wrench and heavy-duty carrying case.
- 3' and 6' extensions for added versatility.

MODEL NO.	DESCRIPTION	HEAT CAPACITY (BTU)	PRICE EACH
H-4693	#3000	153,000 - 260,000	\$800
H-4694	3 ft. Extension		435
H-4695	6 ft. Extension		600



# SHRINK FILM DISPENSER

Maneuvers easily over indoor or outdoor surfaces to get to your product.

- Accommodates pallet covers, large poly sheeting and marine shrink film.
- Holds two 60" rolls. 8" lockable solid rubber casters.

EASY ASSEMBLY. SHIPS VIA UPS.

MODEL NO.	DESCRIPTION	DIMENSIONS L x W x H	CAPACITY (LBS.)	WT. (LBS.)	PRICE EACH
H-5121	Marine Shrink Cart	76 x 24 x 24"	500	85	\$995

# MARINE/INDUSTRIAL SHRINK FILM



\*Available in Blue and White only

SPECIFY COLOR:  Blue  White  Clear

MODEL NO.	ROLL SIZE W x L	APPLICATION	MIL	LBS./ROLL	PRICE PER ROLL		
					1	3	6+
S-10447	12' x 175'	Fishing Boats	7	71	\$223	\$208	\$193
S-10448	14' x 150'	Runabouts	7	71	223	208	193
S-7737	16' x 140'	Pontoon Boats	7	75	238	222	205
S-16308	16' x 372'			200	601	566	531
S-17656*	17' x 120'			69	218	202	189
S-17664*	17' x 350'			200	601	566	531
S-15406	18' x 120'			Large Pontoon Boats	7	73	229
S-17665*	18' x 200'	124	370			346	323
S-10449	20' x 100'	Cabin Cruisers	7	67	212	198	183
S-16309	20' x 298'			200	601	566	531
S-7738	24' x 95'	Cabin Cruisers w/ Arches	7	77	241	225	209
S-17673*	26' x 100'			88	272	255	238
S-17674*	28' x 100'	Charter Fishing Boats	7	95	294	276	256
S-7739	32' x 70'			75	238	222	205
S-17675*	36' x 70'			85	265	249	231
S-15407	40' x 60'			81	300	285	265
S-20786	20' x 100'	Renovation and Transportation	10	96	316	297	283
S-23552▲	20' x 100'	Heavy Equipment and Overseas Freight	12	116	377	361	344

▲ Available in White only

SHIPS VIA MOTOR FREIGHT

Recommended for outdoor storage and protection of heavy-duty equipment.

Protect boats and industrial equipment with the toughest film Uline sells.

- Waterproof, puncture and tear-proof.
- **UVI additive** protects from sun's rays up to 9 months.

**10 Mil** – For renovations and protecting cargo in transit.

**12 Mil** – For heavy equipment and overseas freight.



## MARINE SHRINK ACCESSORIES

SPECIFY COLOR:  Blue  White  Clear

MODEL NO.	SIZE W x L	DESCRIPTION	APPLICATION	MIL	QTY./CTN.	PRICE/ROLL
S-14139*	2" x 180'	Shrink Tape	Quickly patches holes, reinforces stress areas	9	4	\$12
S-10450*	4" x 180'					24
S-16158*	6" x 180'					35
S-14140*	4" x 108'	Hull Tape	Keeps film in place for transport and storage	10	4	24
S-20787▲	6" x 600'	Anti-Chafe Tape	Protects surfaces from scratching and chafing	3	8	55
S-20788▲	12" x 600'					110

▲ Available in White only

\* SOLD IN FULL CARTONS ONLY



# ULINE COLORED LASER LABELS

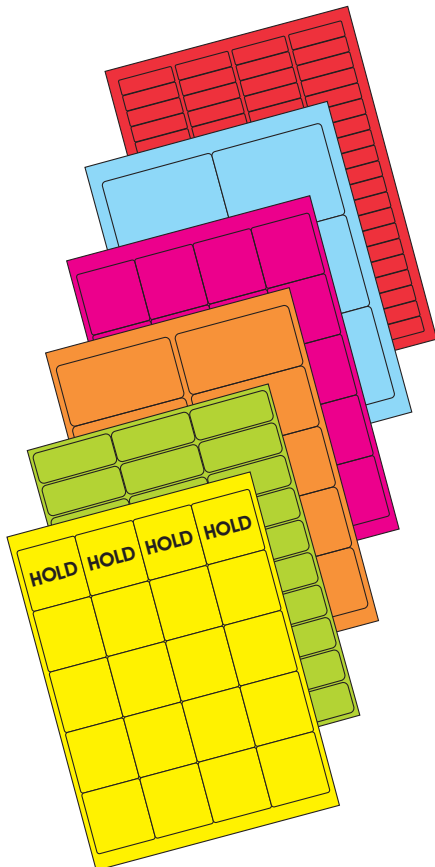

Fluorescent Colors: Make your message pop.

True Colors: Coordinate files and paperwork.

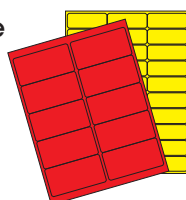

SPECIFY COLOR:

Blue\* Red Orange Yellow Green Pink

## FLUORESCENT COLORS

MODEL NO.	SIZE W x H	LABELS/SHEET	LABELS/BOX	PRICE PER BOX			
				1	2	3	5+
S-17045	1 1/4 x 1/2"	80	8,000	\$42	\$41	\$39	\$36
S-5961	1 1/16 x 1/2"	80	8,000	42	41	39	36
S-17046	2 x 2"	20	2,000	42	41	39	36
S-5047	2 5/8 x 1"	30	3,000	42	41	39	36
S-17047	3 x 1"	20	2,000	42	41	39	36
S-6228	3 x 5"	4	400	42	41	39	36
S-17048	3 1/2 x 5"	4	400	42	41	39	36
S-11246	4 x 1"	20	2,000	42	41	39	36
S-3847	4 x 2"	10	1,000	<b>\$36 per box any quantity</b>			
S-5048	4 x 2 1/2"	8	800	42	41	39	36
S-3848	4 x 3 1/2"	6	600	42	41	39	36
S-3849	4 x 5"	4	400	42	41	39	36
S-6229▲	4 x 6"	4	400	42	41	39	36
S-17049	4 1/4 x 5 1/2"	4	400	42	41	39	36
S-5049	8 1/2 x 5 1/2"	2	200	42	41	39	36
S-5050	8 1/2 x 11"	1	100	42	41	39	36

▲ Legal Size Sheet

\* Pastel Blue

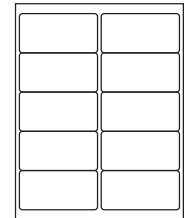

S-3847/S-21852

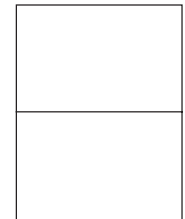

S-5049/S-21854

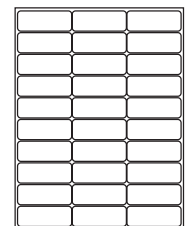

S-5047/S-21851

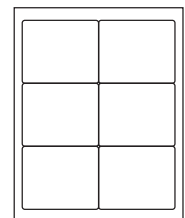

S-3848/S-21853

## TRUE COLORS

SPECIFY COLOR: Red Yellow

MODEL NO.	SIZE W x H	LABELS/SHEET	LABELS/BOX	PRICE PER BOX			
				1	2	3	5+
S-21851	2 5/8 x 1"	30	3,000	\$42	\$41	\$39	\$36
S-21852	4 x 2"	10	1,000	<b>\$36 per box any quantity</b>			
S-21853	4 x 3 1/2"	6	600	42	41	39	36
S-21854	8 1/2 x 5 1/2"	2	200	42	41	39	36
S-21855	8 1/2 x 11"	1	100	42	41	39	36

# ULINE LASER LABEL BULK PACKS



Save time and money with labels for your largest jobs.

- Templates available on [uline.com](http://uline.com)

## WHITE RECTANGLES BULK PACKS

▲ Legal Size Sheet

MODEL NO.	SIZE W x H	LABELS/SHEET	LABELS/BOX	PRICE PER BOX			
				1	2	3	5+
S-20185	1 1/2 x 1"	50	50,000	<b>BULK PACKS</b> Save up to 50% \$150 per box any quantity			
S-17379	1 3/4 x 1/2"	80	80,000				
S-11893	2 5/8 x 1"	30	30,000				
S-17380	3 1/2 x 5"	4	4,000				
S-21856	4 x 1"	20	20,000				
S-19649	4 x 1 1/8"	14	14,000				
S-11892	4 x 2"	10	10,000				
S-12211	4 x 3 1/2"	6	6,000				
S-17381	4 x 5"	4	4,000				
S-12212▲	4 x 6"	4	4,000				
S-17382	4 1/4 x 5 1/2"	4	4,000				
S-11891	8 1/2 x 5 1/2"	2	2,000				
S-14115	8 1/2 x 11"	1	1,000				

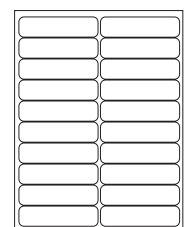

S-11246

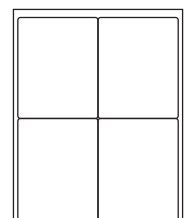

S-3849



# ULINE LASER LABELS

Create your own mailing or inventory labels.

- Heat-resistant adhesive reduces jamming in your laser or inkjet printer.
- High quality labels – Will work in laser and inkjet printers.
- Easy to format with templates in Microsoft® Word™.

## SUGGESTED USES

- |                              |                                    |
|------------------------------|------------------------------------|
| S-5957 – Return addresses    | S-3196 – "To" and "From" addresses |
| S-5042 – Book spines         | S-5044 – Shipping labels           |
| S-10436 – File folder labels | S-5045 – Large pallets             |
| S-5960 – Shelf marking       | S-5046 – Product labeling          |

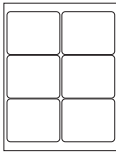

S-3196



S-5044



S-5042

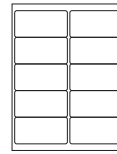

S-3845



S-5492

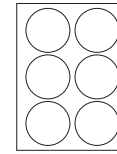

S-10417

## WHITE RECTANGLES

MODEL NO.	SIZE W x H	LABELS/SHEET	LABELS/BOX	PRICE PER BOX			
				1	2	3	5+
S-16986	1/2 x 3/4"	224	22,400	\$31	\$30	\$28	\$26
S-16987	1/2 x 1"	160	16,000	31	30	28	26
S-16988	1/2 x 1 1/4"	96	9,600	31	30	28	26
S-20130	1 x 1/2"	160	16,000	31	30	28	26
S-10433	1 x 1"	80	8,000	31	30	28	26
S-16989	1 1/2 x 1/2"	100	10,000	31	30	28	26
S-20131	1 1/2 x 3/4"	70	7,000	31	30	28	26
S-5959	1 1/2 x 1"	50	5,000	31	30	28	26
S-16990	1 1/2 x 1 1/2"	35	3,500	31	30	28	26
S-5957	1 3/4 x 1/2"	80	8,000	31	30	28	26
S-20133	2 x 1"	40	4,000	31	30	28	26
S-16991	2 x 1 1/4"	32	3,200	31	30	28	26
S-10434	2 x 2"	20	2,000	31	30	28	26
S-20134	2 x 5"	8	800	31	30	28	26
S-21844	2 1/4 x 3/4"	30	3,000	31	30	28	26
S-19344	2 1/2 x 1 1/2"	21	2,100	31	30	28	26
S-5042	2 5/8 x 1"	30	3,000	\$24 per box any quantity			
S-19345	2 5/8 x 2"	15	1,500	31	30	28	26
S-5628	2 3/4 x 2 3/4"	9	900	31	30	28	26
S-19346	3 x 1"	18	1,800	31	30	28	26
S-19643	3 x 2"	10	1,000	31	30	28	26
S-20135	3 x 3"	6	600	31	30	28	26
S-5488	3 x 5"	4	400	31	30	28	26
S-6944	3 1/2 x 2"	10	1,000	31	30	28	26
S-8064	3 1/2 x 5"	4	400	31	30	28	26
S-10436	3 7/16 x 2/3"	30	3,000	31	30	28	26
S-20136	3 3/4 x 4 3/4"	4	400	31	30	28	26
S-5960	4 x 1"	20	2,000	31	30	28	26
S-8039	4 x 1 1/8"	14	1,400	31	30	28	26

## WHITE RECTANGLES

▲ Legal Size Sheet

MODEL NO.	SIZE W x H	LABELS/SHEET	LABELS/BOX	PRICE PER BOX			
				1	2	3	5+
S-5627	4 x 1 1/2"	12	1,200	\$31	\$30	\$28	\$26
S-3845	4 x 2"	10	1,000	\$24 per box any quantity			
S-5043	4 x 2 1/2"	8	800	31	30	28	26
S-10435	4 x 3"	6	600	31	30	28	26
S-3196	4 x 3 3/8"	6	600	\$24 per box any quantity			
S-10437	4 x 4"	4	400	31	30	28	26
S-3846	4 x 5"	4	400	31	30	28	26
S-5492▲	4 x 6"	4	400	\$24 per box any quantity			
S-8065	4 1/4 x 5 1/2"	4	400	31	30	28	26
S-10438▲	4 1/4 x 7"	4	400	31	30	28	26
S-20137	5 x 5"	2	200	31	30	28	26
S-9658	7 1/2 x 2"	5	500	31	30	28	26
S-21846	7 3/4 x 4 3/4"	2	200	31	30	28	26
S-10439	8 x 3 1/2"	3	300	31	30	28	26
S-5044	8 1/2 x 5 1/2"	2	200	\$24 per box any quantity			
S-5045	8 1/2 x 11"	1	100	31	30	28	26
S-10440▲	8 1/2 x 14"	1	100	31	30	28	26

## WHITE CIRCLES

MODEL NO.	LABEL DIAMETER	LABELS/SHEET	LABELS/BOX	PRICE PER BOX			
				1	2	3	5+
S-15580	1/2"	154	15,400	\$31	\$30	\$28	\$26
S-13768	3/4"	108	10,800	31	30	28	26
S-8075	1"	63	6,300	31	30	28	26
S-13769	1 1/2"	30	3,000	31	30	28	26
S-5489	1 3/8"	24	2,400	31	30	28	26
S-14071	2"	20	2,000	31	30	28	26
S-5046	2 1/2"	12	1,200	31	30	28	26
S-10417	3"	6	600	31	30	28	26
S-19347	4"	4	400	31	30	28	26



Create temporary labels for binders, diskettes and file folders.

- Labels lift cleanly – No residue left behind.

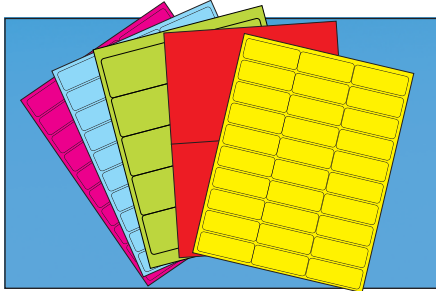

Color code and label your folders, binders and diskettes.

- Clean removal.
- Use in hospitals, schools and warehouses.

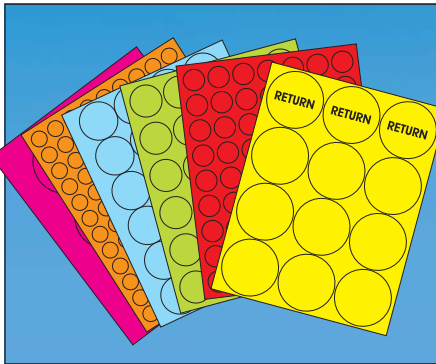

## ULINE FLUORESCENT CIRCLE LABELS

Ideal for product identification, price marking and promotional uses.

- More Colored Laser Labels available, see page 234.

## FOIL LASER LABELS



Unique gold or silver labels draw attention to your product or advertisements.

- High quality laser labels.
- Heat-resistant adhesive reduces jamming.

MODEL NO.	SIZE W x H	LABELS/SHEET	LABELS/BOX	PRICE PER BOX			
				1	2	3	5+
S-8068	1 3/4 x 1/2"	80	8,000				
S-6773	2 5/8 x 1"	30	3,000				
S-6774	4 x 1 1/3"	14	1,400	\$70	\$68	\$66	\$62
S-6775	4 x 2"	10	1,000				
S-8070	8 1/2 x 11"	1	100				

## ULINE REMOVABLE LASER LABELS

### WHITE

MODEL NO.	SIZE W x H	LABELS/SHEET	LABELS/BOX	PRICE PER BOX	
				1	5+
S-18453	1 1/2 x 1"	50	5,000		
S-10432	1 3/4 x 1/2"	80	8,000	\$41	\$36
S-8080	2 5/8 x 1"	30	3,000		
S-18454	3 1/2 x 5"	4	400		
S-15573	4 x 1"	20	2,000		
S-5962	4 x 2"	10	1,000		
S-5963	4 x 3 1/3"	6	600		
S-18455	4 x 5"	4	400	41	36
S-18456▲	4 x 6"	4	400		
S-18457	4 1/4 x 5 1/2"	4	400		
S-5964	8 1/2 x 5 1/2"	2	200	41	36
S-15574	8 1/2 x 11"	1	100		

▲ Legal Size Sheet

### WHITE CIRCLES

S-20175	3/4"	108	10,800	\$41	\$36
S-20176	1"	63	6,300		

### FLUORESCENT

SPECIFY COLOR: Red Blue\* Green Yellow Pink

S-14074	2 5/8 x 1"	30	3,000		
S-14075	4 x 2"	10	1,000	\$48	\$43
S-14076	8 1/2 x 5 1/2"	2	200		

\* Pastel Blue

### RECTANGLES

SPECIFY COLOR: Red Blue\* Green Yellow Orange Pink

MODEL NO.	LABEL DIAMETER	LABELS/SHEET	LABELS/BOX	PRICE PER BOX			
				1	2	3	5+
S-17050	3/4"	108	10,800				
S-10415	1"	63	6,300				
S-17051	1 1/2"	30	3,000				
S-5490	1 1/3"	24	2,400	\$42	\$41	\$39	\$36
S-21848	2"	20	2,000				
S-5051	2 1/2"	12	1,200				
S-10416	3"	6	600				

\* Pastel Blue

### CIRCLES

SPECIFY COLOR: Gold Silver

MODEL NO.	SIZE W x H	LABELS/SHEET	LABELS/BOX	PRICE PER BOX			
				1	2	3	5+
S-10425	2 5/8 x 1"	30	3,000	\$62	\$60	\$59	\$57
S-10426	4 x 2"	10	1,000				

### EMERGENCY SHUT OFF

S-10429	3/4"	108	10,800				
S-10430	1 1/3"	24	2,400	\$62	\$60	\$59	\$57
S-10431	2 1/2"	12	1,200				

## CLEAR LASER LABELS

Graphics show through. Use for inventory or bulk mailings.

- Heat-resistant adhesive.
- Frosted, matte finish.

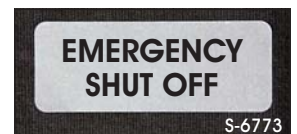

# MAILING LABELS

Seal gift boxes, envelopes or tab mailings.

**Clear Acetate** – Lets your graphics show through. Perforation facilitates easy opening.

**Frosty White Paper** – Keeps envelopes shut when mailing, yet opens with the flick of a finger.

**White Paper** – Stands out on all materials – Distinguishes opening point.

**Manual Dispenser** – Apply labels up to 50% faster than using your hands. For 3/4 to 2" wide labels.

**Automatic Dispenser** – Speedy. Advances, peels and releases labels. Up to 7,000 labels per hour. For 1/4 to 2 1/4" wide labels.



H-7206 – More info, see uline.com



S-5504 CLEAR ACETATE



H-994 DISPENSER

## CLEAR ACETATE

## WAFER SEALS

MODEL NO.	SIZE	QTY./ROLL	PRICE PER ROLL		
			1	5	25+
S-5641	3/4"	5,000	\$24	\$22	\$20
S-6137	3/4" Perfed.		24	22	20
S-5502	1"	5,000	36	32	30
S-6138	1" Perfed.		36	32	30
S-14111	1 1/4"	1,000	17	16	15
S-5503	1 1/2"		20	19	18
S-6931	1 1/2" Perfed.		20	19	18
S-5504	2"	1,000	<b>\$26 per roll any quantity</b>		
S-9991	2" Perfed.		30	28	26
S-6006	2 1/2"	1,000	41	39	36
S-6767	3"	1,000	58	56	53
S-7486	4"	500	52	50	47
S-14112	1 x 1" Square	1,000	21	18	15
S-11394	1 x 2" Rect.		23	19	16
S-11395	2 x 2" Square		37	33	29

## FROSTY WHITE PAPER

MODEL NO.	SIZE	QTY./ROLL	PRICE PER ROLL		
			1	5	25+
S-13185	3/4"	5,000	\$23	\$21	\$18
S-9992	1"	5,000	31	27	25
S-13186	1" Perfed.		31	27	25
S-14952	1 1/2"		47	41	38
S-9993	2"	1,000	23	19	17

## WHITE PAPER

S-9994	1"	5,000	\$25	\$21	\$18
S-13187	1" Perfed.		25	21	18
S-14953	1 1/2"		36	32	28

## DISPENSERS

MODEL NO.	DESCRIPTION	PRICE EACH		
		1	5	25+
H-994	Manual Dispenser	\$28	\$26	\$25
H-7206	Automatic Dispenser	\$645 each 2+/\$635 each		

## CLEAR ACETATE JUMBO ROLLS – For Automated Machines

S-20228	1"	20,000	\$106	\$102	\$98
S-20229	1 1/2"		185	183	180

# PAPER SHREDDERS

FELLOWES®

Protect against identity theft. Shreds important papers, credit cards, even small paper clips. Virtually jam-proof.

- Cross cuts in 5/32 x 1 1/2" shreds. • Quiet operation.
- Stops shredding when hands get too close. • 2" casters.

**H-2608 – 60% faster.** Continuous shredding requires no cool down.

**2 YEAR WARRANTY**

MODEL NO.	DESCRIPTION	DIMENSIONS W x D x H	MAXIMUM RUN TIME	SHEET CAP./PASS	BIN CAP. (GAL.)	PRICE EACH
H-2606	Small	16 x 11 x 20"	20 min.	16	6	\$345
H-2607	Medium	12 x 18 x 26"	30 min.	18	9	480
■H-2608	Large	18 x 18 x 31"	Continuous	22	16	1,355

■ SHIPS VIA MOTOR FREIGHT



SMALL

LARGE

MEDIUM



# QUICK LIFT LASER LABELS



Peel and apply labels up to 30% faster!

- Vertical slits expose label edges when you fold or bend.
- Bright white, smudge-proof.

## WHITE

MODEL NO.	SIZE W x H	LABELS/SHEET	LABELS/BOX	PRICE PER BOX		
				1	3	5+
S-21928	1 1/2 x 1 1/2"	35	3,500			
S-15183	1 3/4 x 1/2"	80	8,000	\$33	\$31	\$29
S-21929	1 3/4 x 2/3"	60	6,000			
S-21930	2 x 2"	12	1,200	\$33	\$31	\$29
S-15184	2 5/8 x 1"	30	3,000			
S-15185	4 x 1"	20	2,000			
S-15186	4 x 2"	10	1,000	\$33	\$31	\$29
S-15187	4 x 3 3/8"	6	600			

# BLOCKOUT LASER LABELS

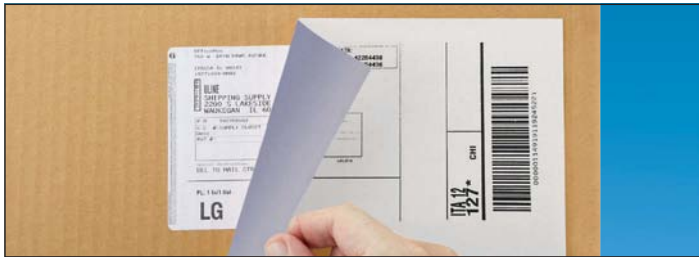

Reuse boxes, tubes and mailers.

- Opaque white or kraft. Block out old shipping labels and markings.
- Won't smudge or jam laser and inkjet printers.

## WHITE

MODEL NO.	SIZE W x H	LABELS/SHEET	LABELS/BOX	PRICE PER BOX		
				1	3	5+
S-21933	2 5/8 x 1"	30	3,000			
S-19321	4 x 2"	10	1,000	\$32	\$31	\$30
S-19322	4 x 3 3/8"	6	600			
S-19323	8 1/2 x 5 1/2"	2	200	\$32	\$31	\$30
S-19324	8 1/2 x 11"	1	100			

## KRAFT

S-16087	8 1/2 x 5 1/2"	2	200	\$72	\$70	\$68
S-21934	8 1/2 x 11"	1	100			



# INTEGRATED LABELS

Print packing lists and shipping labels on the same sheet.

- Combines a paper form and adhesive label into one document.
- Works with shipping software from PayPal®, Stamps.com, UPS, USPS and FedEx®.
- Compatible with laser and inkjet printers.

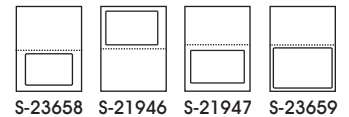

## PERFORATED

MODEL NO.	LABEL SIZE W x H	LABELS/SHEET	LABELS/BOX	PRICE PER BOX		
				1	3	5+
S-23658	6 x 4"	1	100	\$28	\$26	\$21
S-21946	6 3/4 x 4 3/4"					
S-21947	7 x 4 1/4"					
S-23659	7 1/2 x 5 1/8"					



# PLACARD LABEL HOLDERS

INDOOR/OUTDOOR USE

Make any label removable! Specially coated placard holds adhesive labels in place.

- Apply placard to racking, shelves and containers for easy label removal.
- Eliminates adhesive residue and label buildup.

MODEL NO.	PLACARD SIZE	FITS LABEL SIZE	QTY./PACK	PRICE PER PACK		
				1	3	5+
S-23207	2 1/2 x 3 1/2"	2 x 3"	25	\$25	\$23	\$21
S-23208	3 1/2 x 5 1/2"	3 x 5"		27	25	23
S-23209	4 1/2 x 6 1/2"	4 x 6"		35	33	31
S-23210	8 1/2 x 10 1/2"	8 x 10"		60	58	56

# WEATHER RESISTANT LASER LABELS

Ink won't bleed. Weather won't damage.

- Recommended for drums, outside inventory or nursery flower pots.
- Tear-resistant vinyl repels moisture.
- Permanent acrylic adhesive with good initial tack.
- Use only with laser printers and copiers.



## RECTANGLES

MODEL NO.	SIZE W x H	LABELS/SHEET	LABELS/BOX	PRICE PER BOX		
				1	3	5+
S-21906	1 x 1"	80	8,000			
S-19297	1 1/4 x 1/2"	80	8,000	\$97	\$92	\$87
S-20177	2 x 2"	20	2,000			
S-16643	2 3/8 x 1"	30	3,000			
S-21907	3 x 1"	18	1,800			
S-21908	3 x 2"	10	1,000	\$97	\$92	\$87
S-21909	3 x 3"	6	600			
S-20178	3 x 5"	4	400			
S-21910	4 x 1"	20	2,000	\$97	\$92	\$87
S-20179	4 x 1 1/8"	14	1,400			

## RECTANGLES

▲ Legal Size Sheet

MODEL NO.	SIZE W x H	LABELS/SHEET	LABELS/BOX	PRICE PER BOX		
				1	3	5+
S-16644	4 x 2"	10	1,000			
S-19298	4 x 3 1/2"	6	600	\$97	\$92	\$87
S-20180	4 x 4"	4	400			
S-19299▲	4 x 6"	4	400			
S-16645	8 1/2 x 5 1/2"	2	200			
S-19300	8 1/2 x 11"	1	100	\$97	\$92	\$87
S-23660▲	8 1/2 x 14"	1	100			

# GLOSSY WHITE LASER LABELS

Create attractive, photo-finish labels for your products.

- Recommended for packaging, mailings and presentations.
- Use only with laser printers and copiers.



## RECTANGLES

▲ Legal Size Sheet

MODEL NO.	SIZE W x H	LABELS/SHEET	LABELS/BOX	PRICE PER BOX		
				1	3	5+
S-21903	1 1/2 x 1"	50	5,000			
S-10420	2 3/8 x 1"	30	3,000	\$45	\$43	\$41
S-19301	2 3/4 x 2 3/4"	9	900			
S-20181	3 1/2 x 5"	4	400			
S-10421	4 x 2"	10	1,000			
S-10422	4 x 3 1/2"	6	600	\$45	\$43	\$41
S-10423▲	4 x 6"	4	400			
S-10424	8 1/2 x 5 1/2"	2	200			
S-15581	8 1/2 x 11"	1	100	\$45	\$43	\$41
S-21904▲	8 1/2 x 14"	1	100			

## CIRCLES

MODEL NO.	LABEL DIAMETER	LABELS/SHEET	LABELS/BOX	PRICE PER BOX		
				1	3	5+
S-20182	1"	63	6,300			
S-19302	1 1/2"	30	3,000	\$45	\$43	\$41
S-20183	2"	20	2,000			
S-20184	2 1/2"	12	1,200			
S-19303	3"	6	600	\$45	\$43	\$41
S-21905	4"	4	400			

# CRYSTAL CLEAR LASER LABELS



Absolutely crystal-clear gloss label. Use for your finest presentations and mailings.

- Clear polyester with permanent adhesive.
- Non-oozing adhesive. Use only with laser printers and copiers.

MODEL NO.	SIZE W x H	LABELS/SHEET	LABELS/BOX	PRICE PER BOX		
				1	3	5+
S-14854	1 1/4 x 1/2"	80	8,000			
S-21913	2 x 3"	12	1,200			
S-21914	3 x 2"	10	1,000	\$88	\$86	\$83
S-14857	4 x 2"	10	1,000			
S-14858	8 1/2 x 11"	1	100			



P-TOUCH® 410

P-TOUCH® 610BT

**PRINTERS**

- USB cable for PC connection – Create custom labels with barcodes, images and QR codes.
- Full QWERTY keyboard with graphic display.

**P-Touch® 410** – Prints up to 5 lines, stores up to 50 labels.

**P-Touch® 610BT** – Bluetooth® for wireless convenience. Prints up to 7 lines, stores up to 99 labels and has a color display. Carrying case included.

**PRINTERS** Powered by 6 AA batteries or included AC adapter

MODEL NO.	DESCRIPTION	TAPE WIDTH	PRINT SPEED	MAX. RES.	WT. (LBS.)	PRICE EACH	
						1	3+
H-10158	P-Touch® 410	1/8 - 3/4"	20 mm/sec.	180 dpi	3	\$90	\$85
H-10159	P-Touch® 610BT	1/8 - 1"	30 mm/sec.		4	195	190

# BROTHER® P-TOUCH® LABEL MAKERS

Quickly print labels for files, binders and storage bins.



**TZe LABEL TAPE** – Drop-in, easy-to-change cartridges.

- Laminated for indoor/outdoor use.

**TZe LABEL TAPE**

Sold in Multiples of 2

MODEL NO.	COLOR	TAPE WIDTH	TAPE LENGTH	TZe MODEL	PRICE PER CARTRIDGE		
					2	6	12+
S-19336	Black on White	1/4"	314"	211	\$18	\$16	\$15
S-19337		3/8"		221	19	17	16
S-16116		1/2"		231	22	20	18
S-16117		3/4"		241	25	23	21
S-16118		1"		251	28	26	24
S-21857	Black on Clear	1/4"	314"	111	18	16	15
S-21858		3/8"		121	19	17	16
S-21161		1/2"		131	22	20	18
S-21162		3/4"		141	25	23	21
S-21163		1"		151	28	26	24
S-18423	Black on Yellow	1/2"	314"	631	22	20	18
S-18424		3/4"		641	25	23	21
S-18425		1"		651	28	26	24
S-21859	White on Black	1/4"	314"	315	20	18	17
S-21860		1/2"		335	27	25	23
S-22508		3/4"		345	30	28	26
S-23696		1"		355	33	31	29

## BROTHER® LABEL PRINTER

Mr. Speedy prints fast like a jet. Up to 110 labels per minute. For packages and mailing envelopes.



**QL-810W PRINTER**

- Up to 300 x 600 dpi resolution for crisp text and graphics.
- Wireless connectivity. Print from anywhere.

**DK LABELS** – Convenient, drop-in rolls. No ribbons required.

- Permanent adhesive on bright white, high-quality paper.

**S-21867** – 100' continuous roll. Cut to desired size.

**DK LABELS**

Minimum 2 Cartridges

MODEL NO.	SIZE W x H	LABELS/ROLL	BROTHER® MODEL	PRICE PER CARTRIDGE		
				2	6	12+
S-21863	1.1 x 3.5"	400	1201	\$21	\$19	\$17
S-21864	2.4 x 3.9"	300	1202	33	31	29
S-21866	.66 x 2.1"	400	1204	21	19	17
S-22399	1.1 x 2.4"	800	1209	33	31	29
S-21867	2.4" x 100'	1	2205	33	31	29

**PRINTER** PC and Mac compatible

MODEL NO.	DESCRIPTION/ SIZE	MAX. PRINT WIDTH	LABELS/MINUTE	WT. (LBS.)	PRICE EACH	
					1	3+
H-6568	Brother® QL-810W 4 x 4 x 5"	2.4"	110	4	\$240	\$225

## BROTHER® COMPACT COLOR PRINTER

Print full-color labels, photos or name tags for schools, offices and tradeshow.



**VC-500W PRINTER**

- Wireless. Easily design and print from your smart device.
- Built-in cutter for custom length.

**CZ LABELS** – Convenient, drop-in rolls.

- Like a Polaroid picture. Crisp, vivid graphics appear on label. No ribbon required.
- Water, tear and smudge resistant. Adhesive backed.

**PRINTER** PC, Mac, Android and iOS compatible

MODEL NO.	DESCRIPTION/ SIZE	MAX. PRINT W x L	MAX. RES.	WT. (LBS.)	PRICE EACH	
					1	3+
H-8754	Brother® VC-500W 4 x 4 x 5"	2 x 17"	313 dpi	1.5	\$275	\$265

**CZ LABELS**

MODEL NO.	LABEL		BROTHER® MODEL	PRICE PER CARTRIDGE		
	WIDTH	LENGTH		1	3	6+
S-23697	1"	16.4'	CZ-1004	\$45	\$43	\$41
S-23698	2"		CZ-1005	60	57	53



# ZEBRA MOBILE LABEL AND RECEIPT PRINTERS

NO RIBBONS REQUIRED

Print labels on the spot in warehouses, shipping departments and offices.

Totally wireless with WiFi and Bluetooth® connections. Rechargeable lithium ion battery included.

Label Printers – Fantastic color display. Prints immediately even out of sleep mode.

- ZQ620 – Prints labels up to 3" wide.
- ZQ630 – Prints labels up to 4" wide.

Labels – Apply direct thermal labels to corrugated, metal or plastic. Perforated.



Receipt Printer – Print on-demand receipts, invoices and tickets. For car rental returns and postal deliveries.



- Rugged design.
- Paper – Premium white.

LABELS – 3/4" CORE				SOLD IN CASE QUANTITIES		
MODEL NO.	SIZE W x H	LABELS/ROLL	ROLLS/CASE	PRICE PER ROLL		
				24	48	96+
S-13026	2 x 1 1/4"	280	24	\$6	\$5	\$4
S-17071	3 x 1"	565	24	10	9	8
S-17072	3 x 2"	300	24	10	9	8
S-13027*	4 x 2"	300	24	10	9	8
S-13028	4 x 3"	200	24	10	9	8
S-13029*	4 x 6"	105	24	10	9	8

\*Also available in Yellow

## LABEL PRINTERS

MODEL NO.	MFR. NO.	MAX. PRINT W x L	PRINT SPEED	MAX. RES.	PRICE EACH	
					1	2+
H-7889	Zebra ZQ620	2.8 x 32"	4.5"/sec.	203 dpi	\$1,375	\$1,275
H-8740	Zebra ZQ630	4.1 x 32"			1,525	1,495

Drop ships in 3 to 5 days from KY

## RECEIPT PRINTER

Mobile Printer Accessories, see uline.com

MODEL NO.	MFR. NO.	MAX. PRINT W x L	PRINT SPEED	MAX. RES.	PRICE EACH	
					1	2+
H-9575	Zebra ZQ511	2.8 x 39"	5"/sec.	203 dpi	\$840	\$820

Drop ships in 3 to 5 days from KY

## RECEIPT PAPER

MODEL NO.	SIZE W x L	CORE SIZE	ROLLS/CASE	PRICE PER CASE		
				1	3	5+
S-23694	2" x 85'	3/4"	36	\$47	\$44	\$42
S-23695	3" x 85'			55	53	50

# FOLDING HANDI-MOVER

Light and portable for office deliveries and sales calls. Folds down to briefcase size for easy transport.

- Telescoping deck adjusts to 4 lengths.
- Handle extends to 36".
- Lightweight aluminum frame.

MODEL NO.	DECK SIZE W x L	FOLDED DIM. H x W x D	LOAD CAPACITY	WT. (LBS.)	PRICE EACH	
					1	3+
H-5040	17 x 17 - 26"	9 x 17 x 23"	330 lbs.	18	\$140	\$130

SHIPS UNASSEMBLED VIA UPS



- Front and rear bumpers.
- 4" non-marking casters: 2 swivel, 2 rigid.



# DYMO® RHINO PRO LABEL PRINTER

Super fast and easy to use. Print vinyl labels for job site identification on pipes, cables and other tough applications.



- One-touch "Hot Keys" auto format frequently used labels.
- Built-in memory saves more than 100 customized labels.
- Prints up to 5 lines. 14 character, two line display.
- Prints up to 99 copies.

## PRINTER KIT

More information, see uline.com

MODEL NO.	DESCRIPTION/ SIZE	TAPE WIDTH	PRINT SPEED	MAX. RES.	PRICE EACH	
					1	3+
H-4582	Rhino Industrial 5200 Label Maker 11 x 6 x 3"	3/8 - 3/4"	10 mm/sec.	180 dpi	\$260	\$250

## VINYL TAPE

Minimum 2 Cartridges

MODEL NO.	COLOR	TAPE WIDTH	TAPE LENGTH	QTY./ CASE	PRICE PER CARTRIDGE		
					2	5	10+
S-20201	Black on White	3/8"	216"	5	\$25	\$24	\$23
S-20202		1/2"			28	26	24
S-20203		3/4"			31	29	27



**Wax** – Recommended for shipping labels, carton labeling and retail bags. Use with high speed printers.

**Wax/Resin** – Increased resin makes labels smudge and smear-proof. Use with synthetic and colored labels.

**Resin** – Waterproof, grease, chemical and solvent resistant. Use with polyester and synthetic labels.

**Colors** – Recommended for color coding inventory in warehouse and retail applications.

**WAX** SOLD IN CASE QUANTITIES

MODEL NO.	PRINTER TYPE	SIZE W x L	ROLLS/CASE	PRICE PER ROLL			
				4-6	12	24+	
S-6937	Zebra	1.57" x 1,476'	12	N/A	\$6	\$5	
S-7476		2.36" x 984'	12	N/A	6	5	
S-6938		2.36" x 1,476'	12	N/A	11	10	
S-8007		3.14" x 984'	6	\$11	10	9	
S-6941		3.14" x 1,476'	6	17	15	13	
S-7426		3.27" x 984'	6	11	10	9	
S-8008		3.27" x 1,476'	6	17	15	13	
S-6939		3.54" x 1,476'	6	19	17	15	
S-7427		4.02" x 984'	6	14	12	11	
S-6799		4.02" x 1,476'	6	\$17 per roll any case qty.			
S-11313		4.17" x 1,476'	6	23	21	19	
S-6258		4.33" x 984'	6	17	15	13	
S-6259		4.33" x 1,476'	6	\$18 per roll any case qty.			
S-7479		5.12" x 984'	6	18	16	14	
S-7431		5.12" x 1,476'	6	29	26	23	
S-6940		6.02" x 1,476'	6	31	28	25	
S-11314		6.14" x 1,476'	6	31	28	25	
S-7432		6.50" x 1,476'	6	32	29	26	
S-11315		6.85" x 1,476'	6	32	29	26	
S-10762		8.66" x 1,476'	6	39	35	31	
S-8005		Datamax	2.01" x 1,181'	12	N/A	8	7
S-8006			2.52" x 1,181'	12	N/A	10	9
S-7425			3.00" x 1,181'	6	14	12	11
S-6256			4.02" x 1,181'	6	\$13 per roll any case qty.		
S-11317	4.02" x 1,476'		6	22	20	18	
S-7477	4.25" x 1,181'		6	18	16	14	
S-7429	4.33" x 1,181'		6	19	17	15	
S-7478	4.50" x 1,181'		6	19	17	15	
S-6257	Sato	4.02" x 1,345'	6	19	17	15	
S-7430		4.33" x 1,345'	6	22	20	18	
S-21832		6.50" x 1,345'	6	30	28	26	

**WAX** SOLD IN CASE QUANTITIES

MODEL NO.	PRINTER TYPE	SIZE W x L	ROLLS/CASE	PRICE PER ROLL		
				4-6	12	24+
S-7428	Intermec	4.09" x 502'	6	\$11	\$10	\$9
S-11319		4.10" x 1,500'	4	23	21	19
S-11320		4.33" x 502'	6	11	10	9

**WAX/RESIN** SOLD IN CASE QUANTITIES

MODEL NO.	PRINTER TYPE	SIZE W x L	ROLLS/CASE	PRICE PER ROLL			
				6	12	24+	
S-8392	Zebra	2.36" x 1,476'	12	N/A	\$19	\$17	
S-7480		3.14" x 1,476'	6	\$29	26	23	
S-11322		3.54" x 1,476'	6	31	28	25	
S-6800		4.02" x 1,476'	6	32	29	26	
S-7483		4.33" x 984'	6	26	23	21	
S-6943		4.33" x 1,476'	6	33	30	27	
S-10768		5.12" x 1,476'	6	39	35	31	
S-21833		6.50" x 1,476'	6	42	39	36	
S-11323		Datamax	3.00" x 1,181'	6	23	21	19
S-7481			4.02" x 1,181'	6	29	26	23
S-11324	4.50" x 1,181'		6	31	28	25	
S-7482	Sato	4.02" x 1,345'	6	31	28	25	
S-11325	Intermec	4.02" x 502'	6	12	11	10	
S-11326		4.17" x 1,500'	6	33	30	27	

**RESIN** SOLD IN CASE QUANTITIES

MODEL NO.	PRINTER TYPE	SIZE W x L	ROLLS/CASE	PRICE PER ROLL		
				6	12	24+
S-8610	Datamax	4.02" x 1,181'	6	\$46	\$42	\$39
S-18381	Zebra	2.36" x 1,476'	12	N/A	33	28
S-18382		3.27" x 1,476'	6	41	39	38
S-8407		4.33" x 1,476'	6	62	55	49

**COLORS – WAX/RESIN** SPECIFY COLOR: ■ Red ■ Blue ■ Green

MODEL NO.	PRINTER TYPE	SIZE W x L	ROLLS/CASE	PRICE PER ROLL		
				6	12	24+
S-9603	Datamax	4.02" x 1,181'	6	\$50	\$46	\$43
S-8472	Zebra	4.33" x 984'	6	45	41	37
S-10769		4.33" x 1,476'	6	68	62	56

SOLD IN CASE QUANTITIES

# INDUSTRIAL THERMAL TRANSFER LABELS

IN STOCK – SHIPS TODAY

Use with Zebra, Eltron, Fargo, NEC, Datamax and other thermal transfer printers.

- Ideal for shipping labels, barcodes, identification labels, price labels and tags.
- Smooth surface ensures superior print quality.
- Perforated rolls, wound out on a **3" core; 8" outer diameter.**

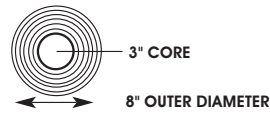

## WHITE SOLD IN CASE QUANTITIES

MODEL NO.	SIZE W x H	LABELS/ROLL	ROLLS/CASE	PRICE PER ROLL		
				4-8	12	24+
S-10765	1 x 1/2" 2-Up	19,200	6	\$30	\$27	\$25
S-7991	1 x 3/4"	6,800	8	18	17	15
S-8336	1 x 1"	5,100	8	18	17	15
S-21868	1 1/2 x 1/2" 2-Up	19,200	4	32	29	27
S-14058	1 1/2 x 1/2"	9,600	8	18	17	15
S-21869	1 1/2 x 3/4"	6,800	8	19	18	16
S-11289	1 1/2 x 1" 2-Up	10,200	4	33	30	28
S-6247	1 1/2 x 1"	5,100	8	18	17	15
S-6248	1 1/2 x 1 1/2"	3,500	8	18	17	15
S-15728	2 x 1/2"	9,600	8	21	20	18
S-16992	2 x 3/4"	6,800	8	20	19	17
S-7410	2 x 1" 2-Up	10,200	4	38	36	33
S-6249	2 x 1"	5,100	8	20	19	17
S-7473	2 x 1 1/4"	4,300	8	24	22	20
S-14059	2 x 1 1/2" 2-Up	7,000	4	37	35	32
S-7411	2 x 1 1/2"	3,500	8	23	21	19
S-21870	2 x 2" 2-Up	5,500	4	39	37	34
S-6250	2 x 2"	2,750	8	20	19	17
S-6784	2 x 3"	1,800	8	21	20	18
S-7474	2 x 4"	1,400	8	23	21	19
S-6785	2 x 5"	1,100	8	23	21	19
S-21871	2 x 6"	1,000	8	24	22	20
S-11290	2 1/4 x 3/4"	6,800	6	25	23	21
S-8338	2 1/4 x 1 1/4"	4,400	6	27	25	23
S-11291	2 1/4 x 2"	2,750	6	26	24	22
S-11292	2 1/2 x 1"	5,100	6	27	25	23
S-6786	2 1/2 x 1 1/2"	3,500	8	27	25	23
S-14060	2 1/2 x 2 1/2"	2,200	6	28	26	24
S-6924	2 1/2 x 5"	1,100	6	26	24	22
S-11293	2 3/4 x 1 1/4"	4,400	6	29	27	25
S-16993	3 x 3/4"	6,800	6	27	25	23
S-5951	3 x 1"	5,100	6	27	25	23
S-7994	3 x 1 1/2"	3,700	6	29	27	25
S-6787	3 x 2"	2,750	6	27	25	23

## WHITE SOLD IN CASE QUANTITIES

MODEL NO.	SIZE W x H	LABELS/ROLL	ROLLS/CASE	PRICE PER ROLL		
				4-8	12	24+
S-6251	3 x 3"	1,800	6	\$26	\$24	\$22
S-6925	3 x 4"	1,400	6	27	25	23
S-6252	3 x 5"	1,100	6	28	26	24
S-8360	3 x 6"	1,000	6	28	26	24
S-22342	3 x 12"	500	6	28	26	24
S-6253	3 1/4 x 5 1/2"	1,000	6	33	30	28
S-6788	3 1/2 x 1"	5,500	4	35	33	30
S-15729	3 1/2 x 1 1/2"	3,500	6	35	33	30
S-14061	3 1/2 x 2"	2,750	4	35	33	30
S-7475	3 1/2 x 5"	1,100	6	36	34	31
S-6789	3 1/2 x 8"	750	4	35	33	30
S-5952	4 x 1"	5,100	4	37	35	32
S-7412	4 x 1 1/2"	3,500	4	40	37	35
S-5035	4 x 2"	2,750	4	\$26/roll any case qty.		
S-5953	4 x 2 1/2"	2,200	4	33	30	28
S-5036	4 x 3"	1,800	4	\$25/roll any case qty.		
S-6254	4 x 4"	1,400	4	29	27	25
S-6790	4 x 5"	1,100	4	36	34	31
S-7413	4 x 6" No Perf.	1,000	4	29	27	25
S-5037	4 x 6"	1,000	4	\$23/roll any case qty.		
S-8433	4 x 6" Weatherproof	950	4	45	42	40
S-5038	4 x 6 1/2"	900	4	29	27	25
S-6933	4 x 8"	750	4	32	29	27
S-7993	4 x 10"	600	4	37	35	32
S-7996	4 x 12"	500	4	38	36	33
S-6935	4 x 13"	500	4	38	36	33
S-7958	4" x 500' Continuous	1	4	39	37	34
S-6792	5 x 3"	1,800	4	40	37	35
S-16995	5 x 7"	875	4	40	37	35
S-12992	5 x 8"	750	4	40	37	35
S-5954	6 x 4"	1,500	4	42	39	37
S-12993	6 x 6"	1,000	4	42	39	37
S-11298	6 x 8"	750	4	42	39	37
S-21872	6 x 9"	675	4	46	42	41



# WEATHERPROOF THERMAL TRANSFER LABELS

RIBBONS REQUIRED

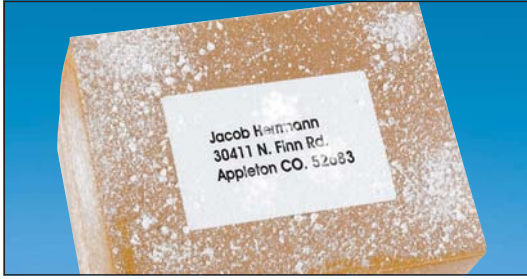

## POLYPROPYLENE

Smudge proof for plant nurseries, lumberyards and shipping. Matte finish.

- UV and moisture resistant. Use outdoors for up to 1 year.

**INDUSTRIAL 3" CORE** Use wax/resin ribbons, page 242

MODEL NO.	SIZE W x H	LABELS/ROLL	ROLLS/CASE	PRICE/ROLL (SOLD PER CASE)		
				4-6	12	24+
S-20142	3 x 1"	5,500	6	\$37	\$35	\$32
S-8412	3 x 2"	2,750	6	37	35	32
S-22429	4 x 1"	5,500	4	45	42	40
S-17067	4 x 2"	3,000	4	45	42	40
S-17068	4 x 3"	2,000	4	45	42	40
S-17069	4 x 4"	1,500	4	45	42	40
S-8433	4 x 6"	950	4	45	42	40

**DESKTOP 1" CORE** Use wax/resin ribbons, page 246

MODEL NO.	SIZE W x H	LABELS/ROLL	ROLLS/CASE	PRICE/ROLL (SOLD PER CASE)		
				12	24	36+
S-22430	2 x 1"	1,300	12	\$18	\$17	\$16
S-22431	3 x 1"	1,300	12	20	19	18
S-22432	3 x 2"	700	12	20	19	18
S-22433	4 x 2"	700	12	23	22	20
S-22434	4 x 3"	500	12	23	22	20
S-22435	4 x 6"	250	12	23	22	20



## POLYESTER

Highest durability for labeling outdoor HVAC and industrial equipment. Glossy finish.

- UV, moisture and chemical resistant.

**INDUSTRIAL 3" CORE** Use resin ribbons, page 242

MODEL NO.	SIZE W x H	LABELS/ROLL	ROLLS/CASE	PRICE/ROLL (SOLD PER CASE)		
				4-6	12	24+
S-18446	2 x 1"	5,500	6	\$85	\$80	\$76
S-18447	3 x 1"	5,500	6	121	115	110
S-18448	3 x 2"	2,750	6	114	109	103
S-18449	4 x 2"	3,000	4	156	150	145
S-18450	4 x 6"	950	4	143	137	132

**DESKTOP 1" CORE** Use resin ribbons, page 246

MODEL NO.	SIZE W x H	LABELS/ROLL	ROLLS/CASE	PRICE/ROLL (SOLD PER CASE)		
				12	24	36+
S-22436	2 x 1"	1,300	12	\$29	\$26	\$24
S-22437	3 x 1"	1,300	12	40	37	35
S-22438	3 x 2"	700	12	40	37	35
S-22439	4 x 2"	700	12	45	43	41
S-22440	4 x 6"	250	12	45	43	41

# INDUSTRIAL THERMAL TRANSFER LABELS/TAGS

RIBBONS REQUIRED



## BLOCKOUT LABELS

Cover old shipping labels to reuse your packaging.

- Opaque design hides serial numbers, barcodes and text.
- Smooth, white surface ensures superior print quality.

**INDUSTRIAL 3" CORE** Use wax ribbons, page 242

MODEL NO.	SIZE W x H	LABELS/ROLL	ROLLS/CASE	PRICE/ROLL (SOLD PER CASE)		
				4	12	24+
S-23578	4 x 2"	3,000	4	\$48	\$46	\$44
S-23579	4 x 6"	1,000		46	44	42



## PERFORATED TAGS

Print important information and barcodes on hang tags.

- 7 pt. cardstock with 1/8" hang hole. **No adhesive.**
- Bright white top coating ensures premium print quality.

**INDUSTRIAL 3" CORE** Use wax ribbons, page 242

MODEL NO.	SIZE W x H	TAGS/ROLL	ROLLS/CASE	PRICE/ROLL (SOLD PER CASE)		
				4	12	24+
S-23580	3 x 5"	1,000	4	\$23	\$20	\$18
S-23581	4 x 6"	800		28	25	23

# INDUSTRIAL THERMAL TRANSFER LABELS



## COLORS

SPECIFY COLOR: ■ Red ■ Orange ■ Yellow ■ Green ■ Blue ■ Pink ■ Purple

MODEL NO.	SIZE W x H	LABELS/ROLL	ROLLS/CASE	PRICE/ROLL (SOLD PER CASE)		
				4-8	12	24+
S-15723	2 x 1"	5,100	8	\$37	\$34	\$32
S-15724	2 x 3"	1,800	8	32	30	28
S-8566	3 x 1"	5,100	6	42	39	37
S-17059	3 x 2"	2,750	6	43	40	38
S-6936	3 x 5"	1,100	6	41	38	36
S-11265	4 x 1"	5,100	4	47	45	42
S-6797	4 x 2"	2,750	4	46	43	41
S-5956	4 x 3"	1,800	4	40	37	35
S-10767	4 x 4"	1,500	4	46	43	41
S-5955	4 x 6"	1,000	4	44	41	39
S-6255	4 x 6½"	900	4	44	41	39
S-17060	4 x 8"	750	4	45	42	40
S-17061	6 x 4"	1,500	4	62	59	57



## RIBBONS REQUIRED



## FLUORESCENT

SPECIFY COLOR: ■ Fl. Blue ■ Fl. Green ■ Fl. Orange ■ Fl. Yellow ■ Fl. Pink

MODEL NO.	SIZE W x H	LABELS/ROLL	ROLLS/CASE	PRICE/ROLL (SOLD PER CASE)		
				4-8	12	24+
S-17062	2 x 3"	1,800	8	\$33	\$31	\$29
S-17063	3 x 5"	1,100	6	44	41	39
S-8597	4 x 2"	2,750	4	49	47	44
S-7989	4 x 3"	1,800	4	44	41	39
S-7990	4 x 6"	1,000	4	47	44	42



Color code products and equipment for easy tracking and identification.

- Perforated rolls have smooth surface for excellent printing.
- Wax/resin ribbons recommended for use with color and fluorescent labels.

## SOLD IN CASE QUANTITIES

MODEL NO.	SIZE W x H	LABELS/ROLL	ROLLS/CASE	PRICE PER ROLL		
				4-8	12	24+
S-9630	1½ x 1"	5,100	8	\$26	\$24	\$22
S-9631	2 x 1"	5,100	8	29	27	25
S-11276	3 x 1"	5,100	6	37	35	33
S-11277	3 x 2"	2,750	6	38	36	34
S-19352	3 x 5"	1,100	6	37	35	33
S-19353	3½ x 1½"	3,700	4	44	41	39
S-19354	4 x 1"	5,100	4	47	44	42
S-10766	4 x 2"	2,750	4	46	43	41
S-8488	4 x 3"	1,800	4	43	40	38
S-19355	4 x 4"	1,500	4	47	44	42
S-7995	4 x 6"	1,000	4	46	43	41

## REMOVABLE ADHESIVE

Ideal for temporary labeling on shelving in warehouses/stores.

- Clean removal.
- Choose from eleven sizes of low gloss matte finish labels.



RIBBONS REQUIRED

MODEL NO.	SIZE W x H	LABELS/BOX	PRICE PER BOX		
			1	3	6+
S-19356	3 x 5"	5,000	\$105	\$101	\$95
S-12994	4 x 2"	12,000	110	105	100
S-7992	4 x 3"	8,000	127	122	117
S-6934	4 x 4"	6,000	127	122	117
S-6795	4 x 6"	4,000	112	107	102
S-14067	4 x 8"	2,800	118	113	108

## FANFOLDED

Cut reloading time in half.

- Fanfold design provides twice as many labels versus roll stock.
- Excellent for storage and future use. Stacks easily.



RIBBONS REQUIRED

**DESKTOP**

# THERMAL TRANSFER LABELS



**RIBBONS REQUIRED**

For use in Zebra, Eltron, Fargo, Sato, NEC, Datamax and other desktop thermal transfer printers.

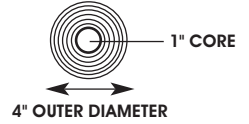

**WHITE** SOLD IN CASE QUANTITIES

MODEL NO.	SIZE W x H	LABELS/ROLL	ROLLS/CASE	PRICE PER ROLL		
				8	12-16	24+
S-21828	1½ x 1/2"	2,400	12	N/A	\$9	\$8
S-16996	1½ x 1"	1,300	12	N/A	9	8
S-21829	2 x 1/2"	2,400	12	N/A	9	8
S-16997	2 x 1"	1,300	12	N/A	9	8
S-21830	2 x 3"	500	12	N/A	9	8

**WHITE** SOLD IN CASE QUANTITIES

MODEL NO.	SIZE W x H	LABELS/ROLL	ROLLS/CASE	PRICE PER ROLL		
				8	12-16	24+
S-16998	2¼ x 1¼"	1,100	12	N/A	\$9	\$8
S-21831	2¼ x 4"	350	12	N/A	10	9
S-15738	3 x 1"	1,300	12	N/A	11	10
S-16999	3 x 2"	700	12	N/A	11	10
S-7997	4 x 1"	1,300	12	N/A	12	11
S-15739	4 x 2"	700	12	N/A	12	11
S-7998	4 x 3"	500	12	N/A	12	11
S-7418	4 x 4"	350	8	\$14	12	11
S-7420	4 x 6"	250	12	N/A	13	12

**COLORS** SPECIFY COLOR: Red Orange Yellow Green Blue

MODEL NO.	SIZE W x H	LABELS/ROLL	ROLLS/CASE	PRICE PER ROLL (SOLD PER CASE)		
				8	12-16	24+
S-7422	2 x 3"	500	12	N/A	\$13	\$12
S-7423	4 x 6"	250	8	\$20	18	16

**DESKTOP**

# THERMAL TRANSFER RIBBONS



For use with dual desktop printers. 1/2" core size.

**Wax Ribbons** – Recommended for shipping labels, carton labeling and retail bags.

**Wax/Resin Ribbons** – Smudge-proof. For use with color labels.

**Resin Ribbons** – Waterproof, grease, chemical and solvent resistant. Use with polyester and synthetic labels.

**SOLD IN CASE QUANTITIES**

MODEL NO.	PRINTER TYPE	RIBBON TYPE	SIZE W x L	ROLLS/CASE	PRICE PER ROLL		
					6-12	24	48+
S-8036	Zebra GC, GK, GX and ZD Series	Wax	2.52" x 244'	12	\$5	\$4	\$3
S-8037			3.30" x 244'		6	5	4
S-8038			4.33" x 244'		9	8	7
S-6942	Zebra T402	Wax	4.33" x 298'	12	9	8	7
S-7428*	Intermec	Wax	4.09" x 502'	6	11	9	8
S-18466	Zebra GC, GK, GX and ZD Series	Wax/Resin	4.33" x 244'	12	13	11	8
S-18467		Resin			20	19	18

\*1" Core

**DESKTOP**

# DUAL BARCODE PRINTERS



Prints both direct thermal and thermal transfer labels.

- 256MB SDRAM/512MB flash.
- Includes USB interface and Bluetooth® LE.
- Prints 2D barcodes, including QR.
- Easy to load both labels and ribbons.

Recommended for printing up to 500 labels per day.

**1 YEAR WARRANTY**

Additional Desktop Printers and options, see [uline.com](http://uline.com)

MODEL NO.	MFR. NO.	PRINT QUALITY	PRINT SPEED	MAX. PRINT W x L	PRICE EACH	
					1	2+
H-9581	ZD421T	203 dpi	6"/sec.	4.09 x 39"	\$615	\$604
H-9582		300 dpi	4"/sec.	4.27 x 39"	640	625

Drop ships in 3 to 5 days from KY

# BARCODE SOFTWARE



Quickly combine barcodes, text and graphics into professional quality labels.

- Prints shipping, compliance or inventory labels and shelf tags.

Arrives via email within 2 business days

MODEL NO.	EDITION	COMPATIBILITY	LICENSES	PRICE EACH
H-8115	Professional 2022	Windows® 10 and Windows® 11	1 User/1 Printer	\$715



# INDUSTRIAL DIRECT THERMAL LABELS

Quality direct thermal material requires no ribbon.

- Recommended for shipping, product identification, barcoding and part bins.

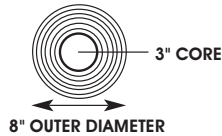

- Use with industrial barcode printers.



## WHITE

SOLD IN CASE QUANTITIES

MODEL NO.	SIZE W x H	LABELS/ROLL	ROLLS/CASE	PRICE PER ROLL		
				2-8	12	24+
S-17054	1 x 1"	5,100	8	\$22	\$20	\$18
S-11266	1½ x 1"	5,100	8	28	26	24
S-20138	1½ x 1½"	3,500	8	25	23	21
S-6260	2 x 1"	5,100	8	27	25	23
S-6261	2 x 1½"	3,500	8	30	28	26
S-10773	2 x 2"	2,750	8	31	29	27
S-17055	2 x 4"	1,400	8	29	27	25
S-11267	2 x 6"	1,000	8	31	29	27
S-8364	2¼ x 1¼"	4,400	6	33	31	29
S-17056	2½ x 1"	5,100	6	33	31	29
S-17057	2½ x 1½"	3,500	6	35	33	31
S-8373	3 x 1"	5,100	6	39	37	35
S-17058	3 x 1½"	3,500	6	37	35	33
S-7433	3 x 2"	2,750	6	41	38	36
S-11269	3 x 3"	1,800	6	43	41	38
S-21841	3 x 4"	1,400	6	42	40	37
S-6262	3 x 5"	1,140	6	42	40	37
S-11270	3½ x 1"	5,100	6	48	46	42
S-8374	4 x 1"	5,100	4	49	47	44
S-19349	4 x 1½"	3,500	4	50	48	46
S-7484	4 x 2"	2,750	4	\$39 per roll any case qty.		
S-13025	4 x 2½"	2,400	4	48	46	43
S-8004	4 x 3"	1,800	4	\$39 per roll any case qty.		
S-8375	4 x 4"	1,400	4	48	46	43
S-11272	4 x 5"	1,100	4	50	48	46

## WHITE

SOLD IN CASE QUANTITIES

MODEL NO.	SIZE W x H	LABELS/ROLL	ROLLS/CASE	PRICE PER ROLL		
				2-8	12	24+
S-6264	4 x 6"	1,000	4	\$39 per roll any case qty.		
S-22386	4 x 6" No Perf.	1,000	4	\$49	\$47	\$44
S-10774*	4 x 6" 12" Diameter	2,450	2	105	100	95
S-9627	4 x 6" Removable	1,000	4	64	62	58
S-20140	4 x 6" w/ 3/4" Tab	900	4	49	47	44
S-9659	4" x 500' Continuous	1	4	48	46	43
S-6265	4 x 6½"	900	4	45	43	40
S-10775	4 x 8"	750	4	50	48	46
S-21843	4 x 12"	500	4	54	51	48
S-11275	5 x 5"	1,100	4	60	58	56

\*12" diameter roll for use with commercial in-line printer/applications

## COLORS

SPECIFY COLOR: Red Orange Yellow Green Blue

MODEL NO.	SIZE W x H	LABELS/ROLL	ROLLS/CASE	PRICE/ROLL (SOLD PER CASE)		
				4-8	12	24+
S-22387	2 x 1"	5,100	8	\$65	\$60	\$55
S-17064	3 x 1"	5,100	6	71	66	58
S-22388	3 x 2"	2,750	6	72	67	59
S-17065	3 x 5"	1,100	6	72	67	59
S-22389	4 x 1"	5,100	4	75	70	62
S-17066	4 x 2"	2,750	4	77	72	64
S-9628	4 x 3"	1,800	4	77	72	64
S-22390	4 x 4"	1,400	4	75	70	62
S-7437	4 x 6"	1,000	4	76	71	63
S-22391	4 x 6½"	900	4	75	70	62

# FANFOLD DIRECT THERMAL LABELS

MODEL NO.	SIZE W x H	COLOR	LABELS/BOX	PRICE PER BOX		
				1	12	24+
S-19348	3 x 2"	White	12,000	\$150	\$145	\$140
S-22396	4 x 1"		22,000	160	155	150
S-21842	4 x 2"		12,000	162	158	152
S-19350	4 x 3"		8,000	152	148	142
S-8376	4 x 6"		4,000	152	148	142
S-22397	4 x 6"	Yellow	4,000	165	160	155
S-19351	4 x 8"	White	3,000	152	148	142

Cut your label reloading time in half.

- Provides twice as many labels.
- Durable topcoated, bright white quality labels.
- Use with desktop or industrial barcode printers.



## DESKTOP DIRECT THERMAL LABELS



Use with Zebra, Eltron, Sato, Datamax and other desktop printers.

- Colors create high visibility for inventory labels.

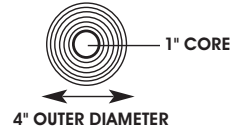

SPECIFY COLOR: Red Orange Yellow Green Blue Pink

MODEL NO.	SIZE W x H	LABELS/ROLL	ROLLS/CASE	PRICE/ROLL (SOLD PER CASE)		
				12	24	36+
S-22418	1½ x 3/4"	1,700	12	\$26	\$24	\$22
S-19476	1½ x 1"	1,300	12	27	24	22
S-7442	2 x 1"	1,300	12	28	25	23
S-19478	2 x 3"	500	12	27	24	22
S-19477	2¼ x 1¼"	1,000	12	28	25	23
S-22419	2¼ x 2"	700	12	30	26	24
S-22420	2½ x 1"	1,500	12	33	28	26

MODEL NO.	SIZE W x H	LABELS/ROLL	ROLLS/CASE	PRICE/ROLL (SOLD PER CASE)		
				12	24	36+
S-15818	3 x 1"	1,300	12	\$31	\$27	\$25
S-15819	3 x 2"	700	12	31	27	25
S-19479	3 x 5"	300	12	31	27	25
S-14064	4 x 1"	1,300	12	33	28	26
S-22421	4 x 1½"	900	12	42	37	33
S-19480	4 x 2"	700	12	34	29	27
S-6927	4 x 3"	500	12	34	29	27
S-6928	4 x 4"	250	12	29	26	23
S-8604	4 x 6"	250	12	31	28	25
S-6929	4 x 6½"	200	12	30	27	24

## DESKTOP REMOVABLE ADHESIVE DIRECT THERMAL LABELS

Recommended for temporary inventory labels on warehouse and retail shelving.

- Use with Zebra, Eltron, Sato, Datamax and other desktop printers.
- Clean removal.

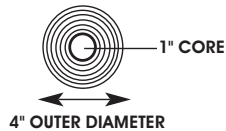

MODEL NO.	SIZE W x H	LABELS/ROLL	ROLLS/CASE	PRICE/ROLL (SOLD PER CASE)		
				12	24	36+
S-18451	2 x 1"	1,600		\$26	\$24	\$22
S-22422	2¼ x 3/4"	2,000		27	25	23
S-18452	2¼ x 1¼"	1,400	12	27	25	23
S-19481	3 x 1"	1,300		28	26	24
S-19482	3 x 2"	700		28	26	24
S-19483	4 x 1"	1,300		27	25	23
S-19485	4 x 2"	700	12	27	25	23
S-21840	4 x 3"	500		29	27	25
S-8487	4 x 6"	250		33	29	27

## DESKTOP DIRECT THERMAL PRINTERS

**NO RIBBONS REQUIRED**

An economical choice for creating shipping, inventory or product labels.

- Easy to load in one step. • Efficient design prevents label jams.
- Includes USB interface and Bluetooth® LE. • Increased memory for faster processing.
- Compatible with Windows®-based software/systems. • Supports EPL and ZPL printer languages.



Drop ships in 3 to 5 days from KY

**1 YEAR WARRANTY**

MODEL NO.	MFR. NO.	PRINT QUALITY	PRINT SPEED	MAX. PRINT W x L	MEMORY	PRICE EACH	
						1	2+
H-9579 H-9580	ZD421D	203 dpi 300 dpi	6"/sec. 4"/sec.	4.09 x 39" 4.27 x 39"	256MB SDRAM/ 512MB Flash	\$530 594	\$514 578

Recommended for printing up to 500 labels per day.

Use with Zebra, Eltron, Sato, Datamax and other desktop printers.

- Bright white labels provide excellent printability for low to medium-speed printers.
- Document Tab: FedEx® S-7485 or UPS style S-7901.

**S-22378 – 5" outer diameter. More labels per roll.**

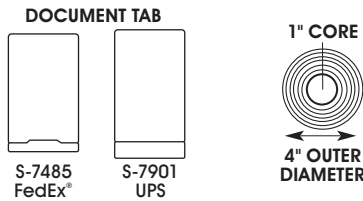

**WHITE**

SOLD IN CASE QUANTITIES

MODEL NO.	SIZE W x H	LABELS/ROLL	ROLLS/CASE	PRICE PER ROLL		
				12	24	36+
S-22370	1 x 1/2"	2,400	12	\$19	\$18	\$17
S-19338	1 x 1/2" 2-Up	4,800	12	19	18	17
S-23605	1 x 1"	1,600	12	19	18	17
S-19339	1 x 1" 2-Up	2,600	12	19	18	17
S-11281	1 x 3"	500	12	13	12	11
S-11280	1½ x 17/20"	1,500	12	16	15	14
S-10763	1¼ x 1"	1,300	12	16	15	14
S-22371	1¼ x 1" 2-Up	2,600	12	28	26	24
S-17355	1½ x 1/2"	2,350	12	16	15	14
S-19340	1½ x 3/4" 2-Up	3,400	12	28	26	24
S-7999	1½ x 1"	1,300	12	17	16	15
S-19341	1½ x 1" 2-Up	2,600	12	28	26	24
S-14062	1½ x 1½"	900	12	17	16	15
S-22372	1½ x 3"	500	12	17	16	15
S-23606	1¾ x 1/2"	2,400	12	17	16	15
S-7439	2 x 1"	1,300	12	17	16	15
S-18451	2 x 1" Removable	1,600	12	26	24	22
S-18458	2 x 1" 2-Up	2,600	12	34	30	28
S-22373	2 x 1¼"	1,000	12	18	17	16
S-11282	2 x 1½"	900	12	18	17	16
S-14063	2 x 2"	700	12	18	17	16
S-22374	2 x 3"	500	12	18	17	16
S-8598	2 x 4"	350	12	19	18	17
S-22375	2 x 6"	250	12	19	18	17
S-22376	2" x 200' Cont.	1	12	18	17	16
S-8599	2¼ x 3/4"	1,700	12	21	19	17
S-18459	2¼ x 1"	1,500	12	19	18	17
S-6801	2¼ x 1½"	1,000	12	\$11 per roll any case qty.		
S-18452	2¼ x 1½" Removable	1,400	12	27	25	23
S-22377	2¼ x 1½" 2-Up	1,800	12	22	21	20
S-8361	2¼ x 2"	700	12	17	16	15
S-8362	2¼ x 3"	500	12	18	17	16

**WHITE**

SOLD IN CASE QUANTITIES

MODEL NO.	SIZE W x H	LABELS/ROLL	ROLLS/CASE	PRICE PER ROLL		
				6-12	24	36+
S-8600	2¼ x 4"	350	12	\$19	\$18	\$17
S-18460	2½ x 1"	1,500	12	21	20	19
S-19342	2½ x 1½"	900	12	22	21	20
S-19343	3 x 3/4"	1,700	12	24	22	20
S-8000	3 x 1"	1,300	12	\$19 per roll any case qty.		
S-18461	3 x 1½"	900	12	24	22	20
S-8363	3 x 2"	700	12	23	21	19
S-11283	3 x 3"	500	12	24	22	20
S-8001	3 x 5"	300	12	25	23	21
S-18462	3½ x 1"	1,500	12	25	23	21
S-11284	3½ x 1½"	900	12	25	23	21
S-18463	3½ x 5"	325	12	25	23	21
S-18464	4 x 1/2"	2,400	12	25	23	21
S-8601	4 x 1"	1,300	12	22	20	18
S-23607	4 x 1¼"	1,000	12	23	21	19
S-8003	4 x 1½"	900	12	23	21	19
S-7440	4 x 2"	700	12	\$17 per roll any case qty.		
S-8602	4 x 2½"	575	12	23	21	19
S-6263	4 x 3"	500	12	\$15 per roll any case qty.		
S-6926	4 x 4"	350	12	21	19	17
S-7441	4 x 5"	300	12	25	23	21
S-6802	4 x 6"	250	12	\$12 per roll any case qty.		
S-8487	4 x 6" Removable	250	12	33	29	27
S-22378	4 x 6" w/ 5" OD	475	6	41	39	37
S-18465	4 x 6¼"	300	12	24	22	20
S-8002	4 x 6½"	200	12	17	15	14
S-7957	4" x 200' Cont.	1	12	26	24	22
S-7485*	4 x 6" w/ 3/4" Tab	245	12	20	18	17
S-7901▲	4 x 6" w/ 2" Tab	185	12	24	22	20
S-10764	4 x 8"	200	12	22	20	18
S-22379	4 x 10"	160	12	22	20	18

\*FedEx® tracking tab ▲UPS style shipping label



# BARCODE SCANNERS



H-1670



H-3813



H-6542



H-6672



2D Barcode



H-6673

## CORDED

Quickly scan shipping and product labels.

- Recommended for light industrial or retail applications.
- Always on. No batteries or recharging necessary.
- Includes stand and USB cable.

## CORDLESS

Wireless convenience works well in warehouse and point-of-sale settings.

- For light industrial or retail applications.
- Wall or countertop mountable.
- Includes base, battery and USB cable.

BASES INCLUDED  
ON ALL CORDLESS  
SCANNERS.

## INDUSTRIAL CORDLESS

Rugged scanner for shipping and warehouse areas.

- For warehouse and industrial applications.
- Reads dirty, damaged barcodes.
- Includes base, battery, cradle adapter cable and USB cable.

## 2D CORDED/CORDLESS

Scans traditional barcode labels (1D) and graphical based labels (2D) for warehouses and shipping.

- Streamline shipping and receiving processes with complete data capture.
- H-6672 – Includes 7 ft. USB straight cable.
- H-6673 – Wireless convenience. Includes base, power supply and USB cable.

▲ Drop ships in 3 to 5 days from KY

\* SPECIFY COLOR: Black or White

MODEL NO.	TYPE	CONNECTION TYPE	READING DISTANCE	TRAVEL DISTANCE FROM BASE	RECOMMENDED USE	WARRANTY	MANUFACTURER NUMBER	USE TIME BETWEEN CHARGES	PRICE EACH
H-1670*▲	1D Coded	USB	17"	6'	Light Industrial	5 YEAR	LS2208	Infinite	\$175
H-3813 H-6542▲	1D Cordless	USB	10" 31"	33' 300'	Light Industrial Warehouse	3 YEAR	Voyager 1202g LI3678	Approx. 12 Hrs.	459 1,010
H-6672▲	2D Coded	USB	24"	7'	Light Industrial	5 YEAR	DS8108	Infinite	465
H-6673▲	2D Cordless	Bluetooth®		328'	Warehouse	3 YEAR	DS8178	Approx. 24 Hrs.	1,080



ZT411

Recommended for printing up to 3,000 labels per day.

Industry-leading performance. Prints up to 14"/second.

- For order picking, shipping and back-of-house operations.
- Easy-to-use 4" touch screen display.

# BARCODE PRINTERS

## INDUSTRIAL

Efficient and durable for heavy warehouse use.

- Direct Thermal and Thermal Transfer labels.
- Windows® compatible only.
- Impressive durability and performance.
- Rugged metal case and full-color display.
- USB, Serial, Ethernet and Bluetooth® interface.

**ADDITIONAL PRINTERS, options and accessories, see [uline.com](http://uline.com)**

- Up to 6" wide
- Up to 600 dpi
- Internal rewind
- Printheads
- Catch tray and cutter



ZT610

Recommended for printing up to 5,000 labels per day.

Zebra's **next generation workhorse** designed for 24/7 use.

- Fulfills high-volume needs with superior print quality.
- 8 times the memory to deliver complex graphics fast.

Drop ships in 3 to 5 days from KY

**1 YEAR WARRANTY**

MODEL NO.	MFR. NO.	PRINT QUALITY	PRINT SPEED	MEMORY	MAX. PRINT W x L	LABEL REQUIREMENTS	PRICE EACH	
							1	2+
H-8906	ZT411	203 dpi	14"/sec.	256MB SDRAM/512MB Flash	4.09 x 157"		\$1,645	\$1,590
H-7378	ZT610	203 dpi	14"/sec.	1GB RAM/2GB Flash	4.09 x 150"		2,600	2,550
H-8725	ZT610	300 dpi	12"/sec.	1GB RAM/2GB Flash	4.09 x 100"		3,325	3,275

# DYMO® LABELWRITER® 500 SERIES PRINTERS

New, faster model for printing inventory and office labels.

- Automatic label recognition tracks type and quantity when connected to a computer.
- 300 dpi. Power and USB cables included.
- PC or Mac compatible. **2 Year Warranty.**

Dymo® 550 – 62 labels per minute.

Dymo® 550 Turbo – 90 labels per minute.

Dymo® 5XL – 53 labels per minute. High-res labels up to 4" wide. USPS quality approved for shipping.



DYMO® 550



DYMO® 5XL

## WHITE PAPER LABELS MIN. 2

MODEL NO.	SIZE W x H	RECOMMENDED USES	LABELS/ROLL	ROLLS/CASE	PRICE PER ROLL		
					2	10	20+
S-25520	1/2 x 1"	Mini Multi-Purpose	1,000	10	\$25	\$24	\$23
S-25521	3/4 x 2"	Return Address	500	10	21	20	19
S-18476	7/8 x 15/16"	Price Tag	400	10	31	30	29
S-25522	1 x 1"	Small Multi-Purpose	750	10	25	24	23
S-24738	1 x 2 1/8"	Multi-Purpose	500	10	21	19	18
S-24739	1 1/8 x 3 1/2"	Small Address	350	20	15	13	12
S-24740	2 1/8 x 4"	Shipping	220	10	22	20	19
S-25523	2 1/4 x 1 1/4"	Identification	1,000	10	30	29	28

## WHITE PAPER LABELS MIN. 2

MODEL NO.	SIZE W x H	RECOMMENDED USES	LABELS/ROLL	ROLLS/CASE	PRICE PER ROLL		
					2	10	20+
S-24741	2 1/16 x 4"	Shipping	300	10	\$25	\$23	\$22
S-25456	4 x 6"	Shipping	220	20	26	24	23

## PRINTERS

MODEL NO.	DESCRIPTION	MAX. PRINT W x L	LABELS/MIN.	PRICE EACH	
				1	2+
H-10012	Dymo® 550	2.3 x 10"	62	\$130	\$120
H-10013	Dymo® 550 Turbo		90	150	140
H-10870	Dymo® 5XL	4 x 6"	53	349	329

## ULINE MINI PRINTER LABELS

NO RIBBONS REQUIRED

Mini direct thermal labels provide excellent printability. Compatible with Dymo® LabelWriter® 400 Series Printers only.

## WHITE PAPER MIN. 2

MODEL NO.	SIZE W x H	RECOMMENDED USES	LABELS/ROLL	ROLLS/CASE	PRICE PER ROLL		
					2	10	20+
S-18475	3/8 x 3/4"	Jewelry	1,500	10	\$51	\$48	\$46
S-9629	9/16 x 3 1/16"	File Folders	130	20	8	7	6
S-14052	1/2 x 1"	Mini Multi-Purpose	1,000	10	16	15	14
S-22413	1/2 x 1 1/8"	Library Label	600	6	11	10	9
S-8503	3/4 x 2"	Return Address	500	10	12	11	10
S-21838	3/4 x 2 1/2"	Barcode Label	450	16	14	13	12
S-12995	1 x 1"	Small Multi-Purpose	750	10	15	14	13
S-18477	1 x 1 1/2"	Small Multi-Purpose	750	20	15	14	13
S-10770	1 x 2 1/8"	Multi-Purpose	500	6	<b>\$13 per roll</b>		
S-8504	1 1/8 x 3 1/2"	Small Address	350	16	<b>\$9 per roll</b>		
S-12953	1 1/8 x 3 1/2"	Large Address	260	20	13	12	11
S-15670	1 1/8 x 1 1/4"	Internet Postage	200	20	16	15	14
S-11285	2 1/8 x 2 3/4"	Disk	320	10	16	15	14
S-11286	2 1/8 x 4"	Shipping	220	6	<b>\$14 per roll</b>		
S-12996	2 1/4 x 1 1/4"	Identification	1,000	10	23	21	19
S-18478	2 1/4 x 4"	Shipping	250	20	23	21	19
S-8505	2 1/16 x 4"	Shipping	300	8	<b>\$15 per roll</b>		
S-17044	4 x 6"	UPS Labels	220	20	<b>\$16 per roll</b>		

## COLOR PAPER SPECIFY COLOR: Yellow Blue Green Red

MODEL NO.	SIZE W x H	RECOMMENDED USES	LABELS/ROLL	ROLLS/CASE	PRICE PER ROLL		
					2	10	20+
S-23719	1 x 2 1/8"	Multi-Purpose	450	16	\$14	\$13	\$12
S-18480	1 1/8 x 3 1/2"	Small Address	350	16	12	11	10
S-22414	2 1/8 x 4"	Shipping	220	6	21	19	18
S-24734	2 1/4 x 1 1/4"	Identification	1,000	10	27	25	23
S-18481	2 1/16 x 4"	Shipping	220	6	20	18	15
S-22416	4 x 6"	UPS Labels	220	20	23	21	19

## REMOVABLE PAPER

MODEL NO.	SIZE W x H	RECOMMENDED USES	LABELS/ROLL	ROLLS/CASE	PRICE PER ROLL
S-24731	1 x 2 1/8"	Multi-Purpose	450	16	\$18 \$16 \$14
S-18482	1 1/8 x 3 1/2"	Small Address	350	16	16 14 12

## WEATHERPROOF POLY

MODEL NO.	SIZE W x H	RECOMMENDED USES	LABELS/ROLL	ROLLS/CASE	PRICE PER ROLL
S-23720	1 x 1 1/2"	Small Multi-Purpose	750	20	\$16 \$15 \$14
S-24732	1 x 2 1/8"	Multi-Purpose	450	16	22 20 18
S-21839	1 1/8 x 3 1/2"	Small Address	300	16	19 17 15
S-22415	2 1/8 x 4"	Shipping	220	6	22 20 19
S-24733	2 1/4 x 1 1/4"	Identification	1,000	10	38 36 34
S-18483	2 1/16 x 4"	Shipping	250	10	21 19 17
S-22417	4 x 6"	UPS Labels	200	20	27 25 23

# INTERNATIONAL SAFE-HANDLING LABELS



3 x 4" S-852

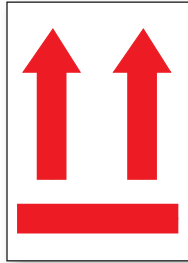

3 x 4" S-850



3 x 4" S-853



S-868, S-869 and S-7409 wrap around edges.



3 x 4" S-851

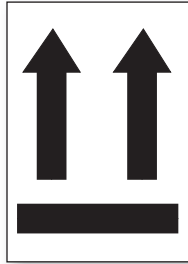

3 x 4" S-20756



3 x 4" S-8236



3 x 4" S-849



3 x 4" S-856

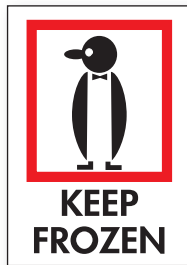

3 x 4" S-857

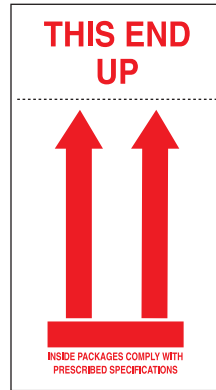

4 x 8" S-868

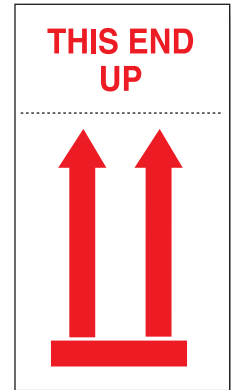

4 x 8" S-869  
2 x 3" S-7409



3 x 4" S-855



3 x 4" S-854



3 x 4" S-3242



4 x 6" S-2862



4 x 6" S-3243



3 x 4" S-859

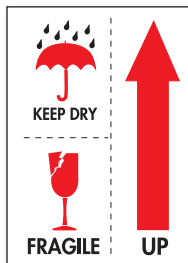

3 x 4" S-8175

Internationally recognizable.

- Pressure-sensitive labels on high-gloss paper.
- Red arrows comply with IATA regulations (S-850, S-868, S-869, S-7409).
- Uline's most attractive labels. Perfect for shipping to customers and VIPs.

- Combine labels for quantity pricing.

SIZE	QTY./ROLL	PRICE PER ROLL			
		1	2	6	10+
2 x 3"	500	\$18	\$17	\$16	\$15
3 x 4"		20	19	18	17
4 x 6"		37	35	32	29
4 x 8"		42	38	35	34



# FRAGILE SHIPPING LABELS



2 x 3" S-6203  
3 x 5" S-5946

Call attention to your fragile shipments with these labels.

- **Quality High Gloss** pressure-sensitive labels.
- Lends a professional appearance to your important shipments.
- 2 x 3" size for smaller packages, multimedia mailers and envelopes.



2 x 3" S-5943  
3 x 5" S-3004



2 x 3" S-6197  
3 x 5" S-3329



2 x 3" S-5944  
3 x 5" S-3514



2 x 3" S-6204  
3 x 5" S-5947



2 x 3" S-6200  
3 x 5" S-3513



2 x 3" S-6198  
3 x 5" S-3005



2 x 2" S-8211  
4 x 4" S-3003



4 x 4" S-3516



2 x 3" S-6201  
3 x 5" S-3515



2 x 3" S-6202  
3 x 5" S-5945

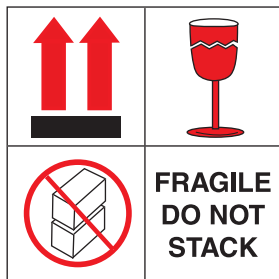

4 x 4" S-6205

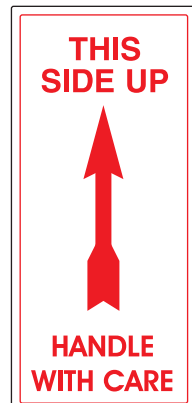

7 x 2 1/2" S-3002



2 x 3" S-6199  
3 x 5" S-3328



2 x 3" S-11443  
3 x 5" S-11444

SIZE	QTY./ROLL	PRICE PER ROLL				
		1	2	5	10	25+
2 x 2"	500	\$25	\$22	\$19	\$16	\$14
2 x 3"		27	24	21	18	16
3 x 5"		33	\$23 per roll			
4 x 4"		34	33	30	27	25
7 x 2 1/2"		36	34	31	28	26



2 x 3" S-261  
3 x 5" S-14072



2 x 3" S-292  
3 x 5" S-14073



2 x 3" S-1228



2 x 3" S-1125



2 x 3" S-3260



2 x 3" S-263



2 x 3" S-262  
3 x 5" S-8251



2 x 3" S-197



2 x 3" S-3418



2 x 3" S-5929



2 x 3" S-603



2 x 3" S-17003



2 x 3" S-8253

- Use on UPSable packages, envelopes and small boxes to ensure proper handling.
- Red fluorescent labels guaranteed to stand out.
- Easy to use – Simply peel and apply.

SIZE	QTY./ROLL	PRICE PER ROLL				
		1	2	5	10	20+
2 x 3"	500	\$16	\$15	\$14	\$13	\$12
3 x 5"		34	32	28	26	24



1½ x 4" S-24214



2" Circle S-8256



2 x 4" S-15561



2 x 3" S-8254  
3 x 5" S-8255

**SHIPPING LABELS**

HIGH GLOSS

Quality high gloss, attractive red labels – Guaranteed to stand out.

- Pressure sensitive, easy to use.

SIZE	QTY./ROLL	PRICE PER ROLL				
		1	2	5	10	20+
1½ x 4"	500	\$25	\$23	\$20	\$18	\$15
2 x 3"		28	25	22	19	17
2 x 4"		31	28	25	22	20
3 x 5"		36	35	32	29	27
2" Circle		24	22	19	17	14

# ULINE SPECIAL HANDLING LABELS

## LARGE 3 x 5"

Ensure proper handling. Eliminate tedious handwritten instructions.

- Recommended for pallets and large packages.
- Large 3 x 5" pressure-sensitive **fluorescent** labels stand out and get noticed.
- Select labels available in 2 x 3" sizes.

Choose from  
over 100 labels  
in 8 categories:

**DO NOT • ENCLOSED • MIXED  
SHIPPING • RECEIVING • CLIMATE  
TOP • FRAGILE**



4 x 6" S-5169

8 x 10" S-6169

### DO NOT



3 x 5" S-601  
2 x 3" S-6168



3 x 5" S-3259  
2 x 3" S-6945

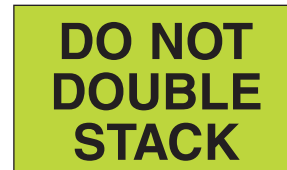

3 x 5" S-1223  
2 x 3" S-6946



3 x 5" S-6170  
2 x 3" S-6947



8 x 10" S-11404  
3 x 5" S-1229  
2 x 3" S-6948



8 x 10" S-11405  
3 x 5" S-1669  
2 x 3" S-6949



3 x 5" S-2581  
2 x 3" S-6950



3 x 5" S-5334



3 x 5" S-2160  
2 x 3" S-6951



3 x 5" S-5917



3 x 5" S-2582



3 x 5" S-6172



3 x 5" S-7397



3 x 5" S-11393



3 x 5" S-1861



3 x 5" S-6173



3 x 5" S-8174



3 x 5" S-7396

SIZE	QTY./ROLL	PRICE PER ROLL				
		1	2	5	10	25+
2 x 3"	500	\$27	\$24	\$21	\$18	\$16
3 x 5"	500	33	31	27	25	23
4 x 6"	500	41	39	36	33	29
8 x 10"	250	65	64	61	59	57



# ULINE SPECIAL HANDLING LABELS

## ENCLOSED



3 x 5" S-6163  
2 x 3" S-11388

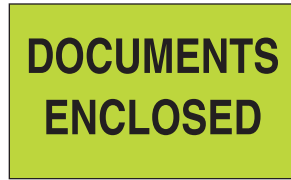

3 x 5" S-5920  
2 x 3" S-13091



3 x 5" S-5918



3 x 5" S-6164

Ensure proper handling. Eliminate tedious handwritten instructions.

- Recommended for pallets and large packages.
- Large 3 x 5" pressure-sensitive **fluorescent** labels stand out and get noticed.
- Select labels available in 2 x 3" sizes.



3 x 5" S-8238



2 x 8" S-6011



2 x 8" S-8239



3 x 5" S-2162

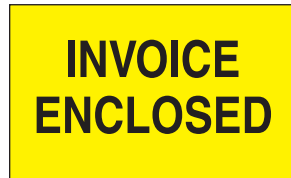

3 x 5" S-7379  
2 x 3" S-8237



3 x 5" S-21124



3 x 5" S-7383

## MIXED



3 x 5" S-7390

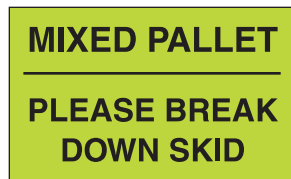

3 x 5" S-6012

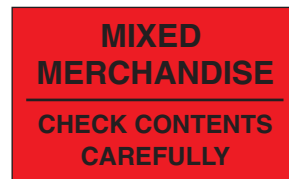

3 x 5" S-11391



3 x 5" S-3261



3 x 5" S-1361



3 x 5" S-5921  
2 x 3" S-11390

SIZE	QTY./ROLL	PRICE PER ROLL				
		1	2	5	10	25+
2 x 3"	500	\$27	\$24	\$21	\$18	\$16
2 x 8"		43	41	37	33	30
3 x 5"		33	31	27	25	23

# ULINE SPECIAL HANDLING LABELS

## SHIPPING

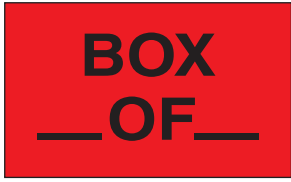

3 x 5" S-5024



3 x 5" S-6158

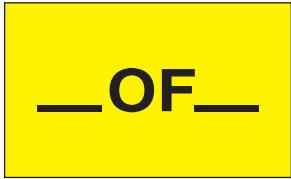

3 x 5" S-13084



3 x 5" S-13085



3 x 5"  
2 x 3" S-2164  
S-8203



3 x 5" S-5936



3 x 5" S-2299



3 x 5" S-13087



3 x 5"  
3 x 8" S-6160  
S-8206



3 x 5" S-13086



3 x 5" S-5919



3 x 5" S-20726



3 x 5" S-20727



3 x 5" S-20728

Take advantage of our huge inventory of labels.

- Large pressure-sensitive **fluorescent** labels stand out and get noticed.
- Select labels available in 2 x 3" and 3 x 8" sizes.
- Ships today from the nearest Uline warehouse.

SIZE	QTY./ROLL	PRICE PER ROLL				
		1	2	5	10	25+
2 x 3"	500	\$27	\$24	\$21	\$18	\$16
3 x 5"		33	31	27	25	23
3 x 8"		46	44	40	36	33

## RECEIVING



3 x 5" S-20729



3 x 5" S-7387



3 x 5" S-24219



3 x 5" S-20731



3 x 5" S-8209



3 x 5" S-8210

SIZE	QTY./ROLL	PRICE PER ROLL				
		1	2	5	10	25+
3 x 5"	500	\$33	\$31	\$27	\$25	\$23

# ULINE SPECIAL HANDLING LABELS

## CLIMATE



3 x 5"  
2 x 3" S-2165  
S-8242



3 x 5" S-7392



3 x 5" S-10369



3 x 5" S-13088



3 x 5" S-13089



3 x 5" S-7394

## TOP



3 x 5" S-602



3 x 5" S-1226



3 x 5" S-2809



3 x 5" S-3265

SIZE	QTY./ROLL	PRICE PER ROLL				
		1	2	5	10	25+
2 x 3"	500	\$27	\$24	\$21	\$18	\$16
3 x 5"		33	31	27	25	23

## SUPER STICKERS



S-3759



S-3761



S-3762



S-1171



S-1174



S-11508



S-1173



S-3967



S-3271

Wrap these fluorescent labels around the corners of your large shipments.

- Adheres to stretch wrap and corrugated.

SIZE	QTY./ROLL	PRICE PER ROLL			
		1	5	10	25+
3 x 10"	250	\$25	\$23	\$21	\$19



## BILL OF LADING LABELS

### 2 IN 1 LABEL

No more searching for labels – Both your skid and BOL labels are included in one convenient product.



MODEL NO.	SIZE	QTY./ROLL	PRICE PER ROLL			
			1	5	10	25+
S-8233	5 x 8"	250	\$61	\$58	\$54	\$51



# ULINE SPECIAL HANDLING LABELS

## FRAGILE



4 x 6" S-604  
2 x 3" S-6157



4 x 6" S-605  
2 x 3" S-11389



4 x 6" S-8240



4 x 6" S-8241

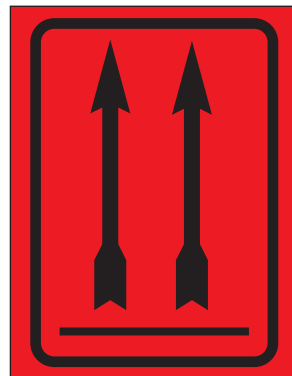

4 x 6" S-606



4 x 6" S-7391



3 x 5" S-1860



3 x 5" S-3262



3 x 5" S-5922



3 x 5" S-6167



3 x 5" S-14103



3 x 5" S-14104



4 x 6" S-14105



4 x 6" S-20725

SIZE	QTY./ROLL	PRICE PER ROLL				
		1	2	5	10	25+
2 x 3"		\$27	\$24	\$21	\$18	\$16
3 x 5"	500	33	31	27	25	23
4 x 6"		41	39	36	33	29

# ANTI-STATIC LABELS

Alert shippers that contents of packages are static sensitive.

- Anti-Static complete line, see pages 740-757.



S-2245\* 2 x 2" S-2246\* 4 x 4"



S-608 2 x 2" S-609 4 x 4"



S-6515 3 x 1 1/4" Resealable Adhesive



S-3417 3 x 2"



S-7608 2 1/2 x 1 1/4"



S-13181 1" Circle



S-7607 2 1/2 x 1 1/4"



S-6516\* 5/8 x 2"



S-7606 1 1/2 x 2 3/4"



S-7605 1 1/2 x 3"



S-11799 2 x 2"

\* MEETS MIL SPEC. STD. 129N

MODEL NO.	STYLE	SIZE H x W	PRICE PER ROLL OF 500			
			1	2	5	10+
S-2245*	Attention	2 x 2"	\$9 per roll any quantity			
S-2246*	Attention	4 x 4"	\$20	\$18	\$17	\$15
S-608	Caution	2 x 2"	12	11	10	9
S-609	Caution	4 x 4"	20	18	17	15
S-6515	Resealable	3 x 1 1/4"	16	14	13	12
S-3417	Special Handling	3 x 2"	14	13	12	11

MODEL NO.	STYLE	SIZE H x W	PRICE PER ROLL OF 500			
			1	2	5	10+
S-7608	Attention	2 1/2 x 1 1/4"	\$13	\$12	\$11	\$10
S-6516*	Attention	5/8 x 2"	10	9	8	7
S-7606	Caution	1 1/2 x 2 3/4"	13	12	11	10
S-7605	Caution	1 1/2 x 3"	13	12	11	10
S-13181	RoHS Compliant	1" Circle	14	13	12	11
S-11799	RoHS Compliant	2 x 2"	16	14	13	12
S-7607	Attention	2 1/2 x 1 1/4"	13	12	11	10

# CUSTOM PRINTED ASSET LABELS



Durable polyester asset labels with optional barcode and sequential numbering.

- Track your valuable company assets.
- Temperature range -40° to 302°F.



## ORDERING INFORMATION

1. Select color.
2. Provide company name.
3. Select starting number.

SPECIFY COLOR: █ Black █ Green █ Red █ Blue

MODEL NO.	SIZE H x W	QTY./ ROLL	PRICE PER ROLL (MIN. 3)		
			3	5	10+
S-17239	3/4 x 1 1/2"	100	\$190	\$140	\$80

# SECURITY LABELS



Ensure safe transit for important documents.

- If tampered with, label breaks instantly.



Void message shows immediately upon label removal.

- Impossible to reseal or reuse.

## "TAMPER RESISTANT"

MODEL NO.	DESCRIPTION	SIZE H x W	QTY./ ROLL	PRICE PER ROLL		
				1	5	10+
S-8324	Tamper Resistant	5/8 x 1 1/4"	500	\$15	\$13	\$12
S-8325	Tamper Resistant	1 1/2 x 6 3/4"	100	22	19	17

## TAMPER EVIDENT – "PROPERTY OF" with Sequence and Write-on Surface

MODEL NO.	SEQUENCE	SIZE H x W	QTY./ ROLL	PRICE PER ROLL
S-8326	0001 - 0100	3/4 x 2"	100	\$36
S-8327	0101 - 0200			
S-8328	0201 - 0300			

## "WARRANTY VOID IF REMOVED"

SPECIFY COLOR: Red or Silver

MODEL NO.	DESCRIPTION	SIZE H x W	QTY./ ROLL	PRICE PER ROLL
S-13124	N/A	3/4 x 2"	100	\$36



4 x 6" S-13048

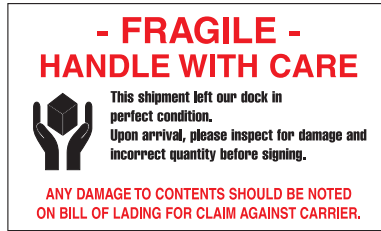

4 x 6" S-5364



8 x 10" S-11403



4 x 6" S-5360

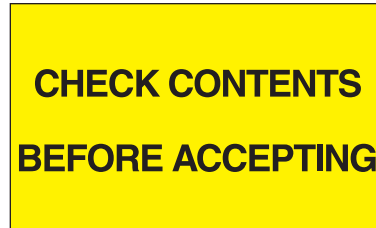

4 x 6" S-8200



10 x 6" S-7377



3 x 5" S-5361

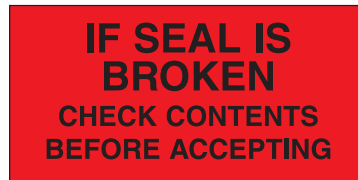

3 x 5" S-5362

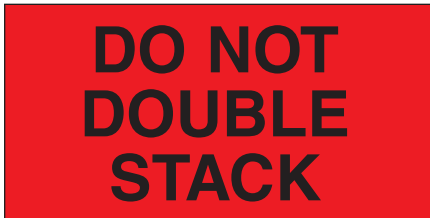

1 x 3" S-8199  
8 x 10" S-6169



8 x 10" S-8201



8 x 10" S-8202



8 x 10" S-7378



8 x 10" S-11404

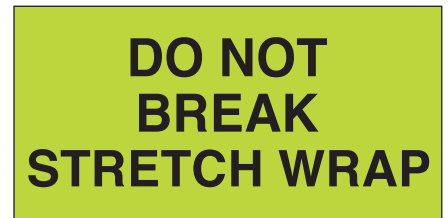

8 x 10" S-11405

- Avoid unnecessary product damage and claim disputes.
- **Fluorescent** labels get noticed on skids and large shipments.
- Protect your shipments from pilferage.

SIZE	QTY./ROLL	PRICE PER ROLL				
		1	2	5	10	25+
1 x 3"	500	\$20	\$19	\$17	\$15	\$13
3 x 5"	500	33	31	27	25	23

SIZE	QTY./ROLL	PRICE PER ROLL				
		1	2	5	10	25+
4 x 6"	500	\$41	\$39	\$36	\$33	\$29
10 x 6"	250	57	56	53	50	48
8 x 10"	250	65	64	61	59	57



# INVENTORY CONTROL LABELS



Custom print your own messages, see pages 267-270.

## INVENTORY



2" S-3017



2" S-5916



2" S-24217  
3" S-24218



2" S-24794  
3" S-24795



2" S-3018



2" S-7374



2" S-5635



2" S-20759

## QUALITY



1" S-11399  
2" S-5913



2" S-5914



2" S-8161



1" S-13118  
2" S-8162



2" S-24240



2" S-10371



2" S-10372



1" S-13119  
2" S-13120

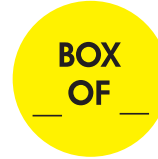

2" S-5915



2" S-7373



2" S-8158



2" S-10370



1" S-11400  
2" S-8164



2" S-1127



2" S-6682



2" S-20761



2" S-11401



2" S-14077



2" S-14078



1 x 3" S-13121

SIZE	QTY./ROLL	PRICE PER ROLL		
		1	5	10+
1" Circle	500	\$19	\$16	\$14
2" Circle		23	20	18
3" Circle		35	30	27
1 x 3"		22	19	16

## REMOVABLE ADHESIVE

Use in warehouse or office for temporary color coding, identification or inventory.

- Clean removal leaves no residue.
- Writable surface.
- Sticks to corrugated, glass and paper.

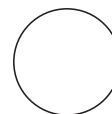
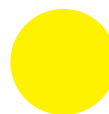

SPECIFY COLOR: Fl. Red, Fl. Green, Fl. Orange, Fl. Yellow, White, Blue or Clear

MODEL NO.	DESCRIPTION	DIAMETER	QTY./ROLL	PRICE PER ROLL	
				1	3+
S-13122	Removable Labels	3/4"	1,000	\$14	\$12
S-11441		1"		19	17
S-11442		2"		25	23

# INVENTORY LABELS

## RECTANGLES

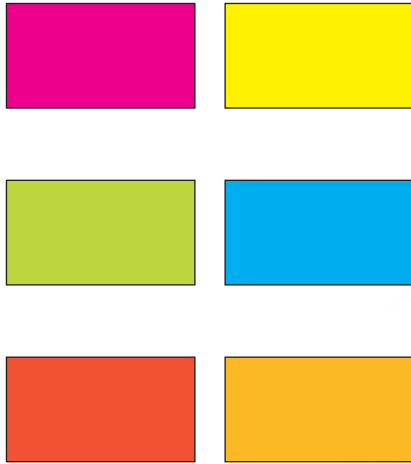

## CIRCLES



These labels aid your warehouse operations.

- Categorize inventory, reorder points, product dating or special instructions.
- Apply these labels to pallets, boxes and shelves for easy identification.
- Easy to write on.

### RECTANGLES

MODEL NO.	SIZE	PRICE PER 1,000				
		1	3	5	10	25+
S-2568	2 x 3"	\$27	\$26	\$24	\$22	\$20
S-2569	2 x 4"	33	32	30	28	25
S-2570	3 x 5"	47	45	43	41	38
S-2571	3 x 9"	82	81	72	67	63
S-17079	4 x 4"	56	55	50	46	42
S-2768	4 x 6"	64	62	59	54	49
S-2769	5 x 7"	90	85	81	77	75

### CIRCLES

MODEL NO.	SIZE	PRICE PER 1,000				
		1	3	5	10	25+
S-2063	1/2"	\$14	\$13	\$12	\$11	\$9
S-3449	3/4"	16	14	13	12	10
S-2235	1"	18	16	15	13	11
S-2775	1 1/2"	20	18	17	15	13
S-1176	2"	22	20	19	17	15
S-1177	3"	34	31	29	27	25
S-2064	4"	55	49	47	45	41

### FLUORESCENT PACK – 1,000 each: Red, Yellow, Orange, Green, Pink

MODEL NO.	SIZE	QTY./PKG.	PRICE PER PACKAGE	
S-3873	2 x 3" Rect.	5,000	1 pkg. \$103	2+ \$98
S-3874	2 x 4" Rect.		1 pkg. \$133	2+ \$129
S-3875	3 x 5" Rect.		1 pkg. \$188	2+ \$187

### FLUORESCENT PACK – 1,000 each: Red, Yellow, Orange, Green, Pink

MODEL NO.	SIZE	QTY./PKG.	PRICE PER PACKAGE	
S-3870	1" Circles	5,000	1 pkg. \$67	2+ \$57
S-3871	2" Circles		1 pkg. \$87	2+ \$77
S-3872	3" Circles		1 pkg. \$134	2+ \$124

FLUORESCENT:  Red  Yellow  Orange  Green  Pink

CHOOSE FROM 12 AVAILABLE COLORS FOR CIRCLES AND RECTANGLES. REGULAR:  Green  Royal  Lt. Blue  White  Red  Purple  Black

## FOLDING CART

Portable work surface for staying ahead of projects.

- Laminate top. Vinyl trim.
- 1" deep wire basket.
- 4" polyolefin swivel casters.



MODEL NO.	DIMENSIONS L x W x H	LOAD CAPACITY	WT. (LBS.)	PRICE EACH	
				1	3+
H-5070	29 x 19 x 29"	350 lbs.	32	\$160	\$150

## BLOCK OUT LABELS

Cover unwanted box markings.

- Blends neatly with corrugated.
- Specify Kraft or White.

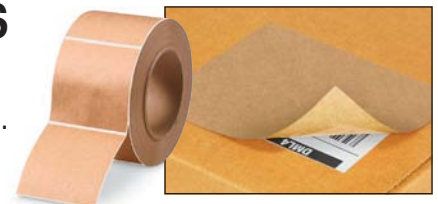

MODEL NO.	SIZE	QTY./ROLL	PRICE PER ROLL	
			1	2+
S-21768	1 x 1"	1,000	\$12	\$10
S-11410	2 x 3"	500	25	23
S-21769	2 x 6"	500	31	28
S-15653	3 x 5"	500	37	34

MODEL NO.	SIZE	QTY./ROLL	PRICE PER ROLL	
			1	2+
S-11411	4 x 6"	500	\$50	\$45
S-21770	5 x 7"	250	60	58
S-21771	6 x 6"	250	60	58
S-13123	8 x 10"	250	74	68

# PRE-PRINTED INVENTORY LABELS



## NUMBERS



1" S-13094  
2" S-3016  
3" S-8214  
4" S-7399



1" S-13095  
2" S-3007  
3" S-8215  
4" S-7400



1" S-13096  
2" S-3008  
3" S-8216  
4" S-7401



1" S-13097  
2" S-3009  
3" S-8217  
4" S-7402



1" S-13098  
2" S-3010  
3" S-8218  
4" S-7403



1" S-13099  
2" S-3011  
3" S-8219  
4" S-7404



2" S-3012  
3" S-8220



2" S-3013  
3" S-8221



2" S-3014  
3" S-8223



2" S-3015  
3" S-8224



2" S-5642  
3" S-8225



2" S-5643  
3" S-8226



2" S-5648



2" S-5649



2" S-5644  
3" S-8227



2" S-5645  
3" S-8228



2" S-5646  
3" S-8229



2" S-5647  
3" S-8230



2" S-24217  
3" S-24218



2" S-24794  
3" S-24795



2" S-5650



2" S-5651

MODEL NO.	SIZE	QTY./ROLL	PRICE PER ROLL		
			1	5	10+
S-13094 to S-13099	1" Circle	500	\$19	\$16	\$14
S-3007 to S-24794	2" Circle		23	20	18
S-8214 to S-24795	3" Circle		35	30	27
S-7399 to S-7404	4" Circle		55	50	45

# INSPECTION LABELS

## VINYL CLOTH

## SELF-LAMINATING



S-9929



S-5927



S-5925

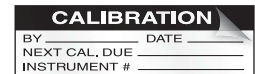

S-20762



S-5926

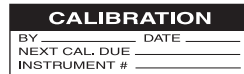

S-11407



S-13101



S-20763

Keep track of preventive maintenance on your equipment.

Vinyl Cloth – Removable and **repositionable**. Easy to write on.

Self-Laminating – Lasts twice as long. Polyester with clear laminate to seal in your writing.

DESCRIPTION	SIZE	QTY./PACK	PRICE PER PACK		
			1	5	10+
Vinyl Cloth	1½ x 5/8"	350	\$37	\$34	\$31
Self-Laminating			73	69	65

# EASY ORDER PACKS

Convenient, prepacked boxes with your choice of months or numbers.

- Ideal for organizing shipments or incoming product.
- Contains one roll of each. 500 per roll.

MODEL NO.	DESCRIPTION	SIZE	PRICE PER PACKAGE	
			1	2+
S-3440	Months of Year	2 x 3"	\$217	\$185
S-8155	Months of Year	2" Circle	205	174
S-8156	Numbers (1-10)	2" Circle	171	146

SAVE UP TO 23%



MONTHS OF THE YEAR



NUMBERS



# PRE-PRINTED INVENTORY LABELS

MONTHS OF THE YEAR



## RECTANGLES

<b>JAN</b> 2 x 3" S-2243 3 x 6" S-2065	<b>FEB</b> 2 x 3" S-2244 3 x 6" S-2092	<b>MAR</b> 2 x 3" S-2286 3 x 6" S-2093
<b>APR</b> 2 x 3" S-2287 3 x 6" S-2094	<b>MAY</b> 2 x 3" S-2288 3 x 6" S-2095	<b>JUN</b> 2 x 3" S-2289 3 x 6" S-2096
<b>JUL</b> 2 x 3" S-2290 3 x 6" S-2097	<b>AUG</b> 2 x 3" S-2291 3 x 6" S-2098	<b>SEPT</b> 2 x 3" S-2292 3 x 6" S-2099
<b>OCT</b> 2 x 3" S-2293 3 x 6" S-2100	<b>NOV</b> 2 x 3" S-2294 3 x 6" S-2101	<b>DEC</b> 2 x 3" S-2295 3 x 6" S-2102

## CIRCLES

<b>JAN</b> 1" S-15547 2" S-8300	<b>FEB</b> 1" S-15548 2" S-8301	<b>MAR</b> 1" S-15549 2" S-8302	<b>APR</b> 1" S-15550 2" S-8303
<b>MAY</b> 1" S-15551 2" S-8304	<b>JUN</b> 1" S-15552 2" S-8305	<b>JUL</b> 1" S-15553 2" S-8306	<b>AUG</b> 1" S-15554 2" S-8307
<b>SEP</b> 1" S-15555 2" S-8308	<b>OCT</b> 1" S-15556 2" S-8309	<b>NOV</b> 1" S-15557 2" S-8310	<b>DEC</b> 1" S-15558 2" S-8311

- Rotate or date stock with these pressure-sensitive labels.
- Combinable for volume pricing.

MODEL NO.	SIZE	QTY./ROLL	PRICE PER ROLL		
			1	5	10+
S-2243 to S-2295	2 x 3"	500	\$24	\$21	\$19
S-2065 to S-2102	3 x 6"		38	33	30
S-15547 to S-15558	1" Circle		19	16	14
S-8300 to S-8311	2" Circle		23	20	18

## DAYS OF THE WEEK

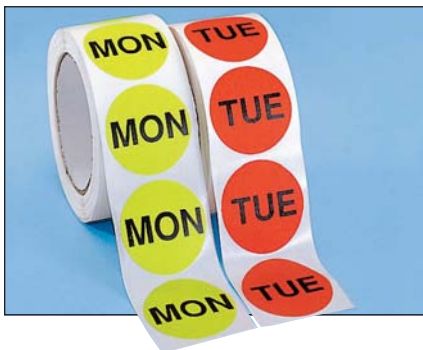

<b>MON</b> 1" S-5905 2" S-2776	<b>TUE</b> 1" S-5906 2" S-2777	<b>WED</b> 1" S-5907 2" S-2778	<b>THU</b> 1" S-5908 2" S-2779
<b>FRI</b> 1" S-5909 2" S-2780	<b>SAT</b> 1" S-5910 2" S-2781	<b>SUN</b> 1" S-5911 2" S-2782	

MODEL NO.	SIZE	QTY./ROLL	PRICE PER ROLL		
			1	5	10+
S-5905 to S-5911	1" Circle	500	\$19	\$16	\$14
S-2776 to S-2782	2" Circle		23	20	18

## CONSECUTIVE NUMBERS

Keep track of skids, count incoming inventory and identify product.

- Pressure-sensitive labels with easy-to-read 1/2" numbers.

MODEL NO. / SEQUENCE	MODEL NO. / SEQUENCE	SIZE	PRICE PER ROLL		
			1	2	4+
S-8319 / 0001 - 0500	S-8322 / 1501 - 2000	1 x 1 1/2"	\$26	\$23	\$19
S-8320 / 0501 - 1000	S-8323 / 2001 - 2500				
S-8321 / 1001 - 1500					



# PRE-PRINTED INVENTORY LABELS



2 x 3" S-8171



2 x 3" S-8170



2 x 3" S-8172



2 x 3" S-8169



2 x 3" S-8167



2 x 3" S-24207



2 x 3" S-14090



2 x 3" S-13112



2 x 3" S-13113



2 x 3" S-14088



2 x 3" S-24208



2 x 3" S-8168

- Use for all of your inventory and warehouse needs.
- Pressure-sensitive **fluorescent** labels stand out and get noticed.

MODEL NO.	SIZE	QTY./ROLL	PRICE PER ROLL		
			1	5	10+
S-8167 to S-24208	2 x 3"	500	\$27	\$19	\$16



2 x 3" S-14091



2 x 3" S-13115

## DISPOSAL/TRASH LABELS



2 x 3" S-11402



2 x 3" S-8173



2 x 3" S-13114



2 x 3" S-20764



Clearly mark trash and recycling at your workplace. Pressure sensitive.

MODEL NO.	SIZE	QTY./ROLL	PRICE PER ROLL		
			1	5	10+
S-8173 to S-20764	2 x 3"	500	\$27	\$19	\$16

## "MADE IN..." LABELS



Proudly display where your products are made.

- Printed on attractive white high-gloss stock.
- Additional "Made In" labels, see [uline.com](http://uline.com)



S-17021

**MADE IN USA LABELS** "Made in U.S.A." Tape, pg. 842

MODEL NO.	SIZE	CORE SIZE	PRICE PER ROLL OF 500			
			1	5	10	25+
S-3419	5/8 x 5/8"	1"	\$11	\$10	\$9	\$8
S-1973	1 x 1"		12	11	10	9
S-17021	1" Circle		12	11	10	9
S-14107	2 x 2"		17	16	15	14
S-1974	2 x 3"		18	17	16	15
S-1975	4 x 4"		30	29	28	27

## STORAGE BOXES



STERILITE®

Made in USA

MODEL NO.	INSIDE DIM. L x W x H	QTY./CTN.	PRICE/CTN.	
			1	3+
S-21901	17 x 13 x 15"	8	\$112	\$106
S-21902	24 x 14 x 17"	6	136	129

# PRODUCTION LABELS



1 1/4 x 2" S-325  
3 x 5" S-2579



1 1/4 x 2" S-8176  
3 x 5" S-8177



1 1/4 x 2" S-323  
3 x 5" S-2576

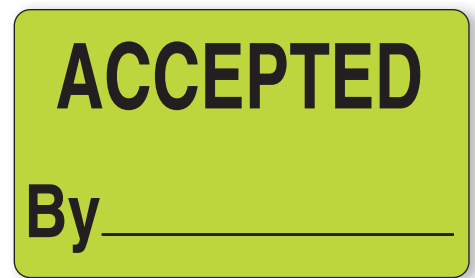

1 1/4 x 2" S-324 **LARGE** 3 x 5" S-2575



1 1/4 x 2" S-11412  
3 x 5" S-11414

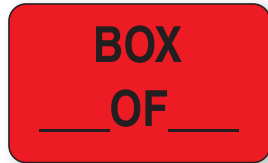

1 1/4 x 2" S-5023  
3 x 5" S-5024



1 1/4 x 2" S-8182  
3 x 5" S-8183



1 1/4 x 2" S-322 **LARGE** 3 x 5" S-2577



1 1/4 x 2" S-8188  
3 x 5" S-8189



1 1/4 x 2" S-8190  
3 x 5" S-8191



1 1/4 x 2" S-406  
3 x 5" S-2857

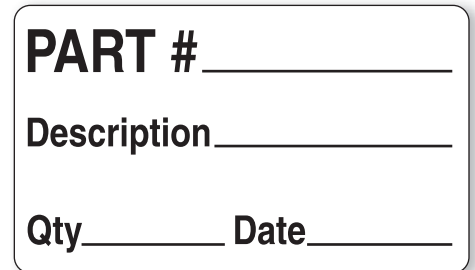

1 1/4 x 2" S-15517 **LARGE** 3 x 5" S-11387



1 1/4 x 2" S-8194  
3 x 5" S-8195



1 1/4 x 2" S-8196  
3 x 5" S-8197



1 1/4 x 2" S-5021  
3 x 5" S-5022

Simplify inventory and quality control operations with these labels.

- Large 3 x 5" perfect for skids and large shipments.
- Easy to write on with pen, pencil or marker.

MODEL NO.	SIZE	QTY./ROLL	PRICE PER ROLL				
			1	2	5	10	25+
S-322 to S-15517	1 1/4 x 2"	1,000	\$21	\$19	\$16	\$15	\$13
S-2575 to S-11414	3 x 5"	500	34	31	28	25	23

# CUSTOM PRINTED LABELS

## SQUARES



2 x 2" S-2812



3 x 3" S-2169



4 x 4" S-2806



5 x 5" S-6207

MODEL NO.	SIZE	PRICE PER 1,000							
		1	2	3	5	10	25	30+	
S-2812	2 x 2"	\$71	\$64	\$59	\$51	\$34	\$26		
S-2169	3 x 3"	93	82	71	63	49	40	CALL	
S-2806	4 x 4"	149	132	112	89	67	51	FOR	
S-6207	5 x 5"	226	195	164	132	102	81	QUOTE	
S-20746	6 x 6"	266	234	194	160	125	104		



6 x 6" S-20746

Ordering Instructions, see page 268.



# CUSTOM PRINTED LABELS

# CIRCLES



MODEL NO.	DIAM.	PRICE PER 1,000					
		1	2	3	5	10	25+
S-450	1/2"	\$59	\$52	\$36	\$32	\$19	\$17
S-6211	3/4"	61	53	37	33	20	18
S-2166	1"	64	58	48	42	28	23
S-2801	1 1/2"	69	63	52	45	30	25
S-451	2"	74	66	57	51	32	26

MODEL NO.	DIAM.	PRICE PER 1,000					
		1	2	3	5	10	25+
S-2270	2 1/2"	\$77	\$70	\$63	\$56	\$39	\$31
S-2168	3"	92	83	73	67	52	40
S-6212	3 1/2"	120	110	95	80	67	50
S-2991	4"	217	189	155	119	85	64
S-2992	5"	271	237	195	168	142	103

# OVALS

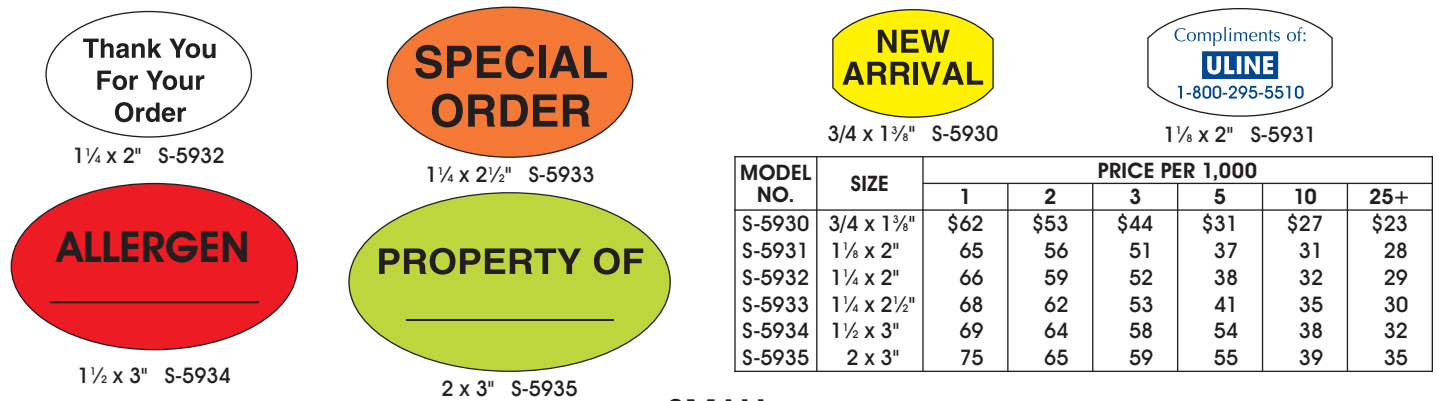

MODEL NO.	SIZE	PRICE PER 1,000					
		1	2	3	5	10	25+
S-5930	3/4 x 1 1/8"	\$62	\$53	\$44	\$31	\$27	\$23
S-5931	1 1/8 x 2"	65	56	51	37	31	28
S-5932	1 1/4 x 2"	66	59	52	38	32	29
S-5933	1 1/4 x 2 1/2"	68	62	53	41	35	30
S-5934	1 1/2 x 3"	69	64	58	54	38	32
S-5935	2 x 3"	75	65	59	55	39	35

# SMALL

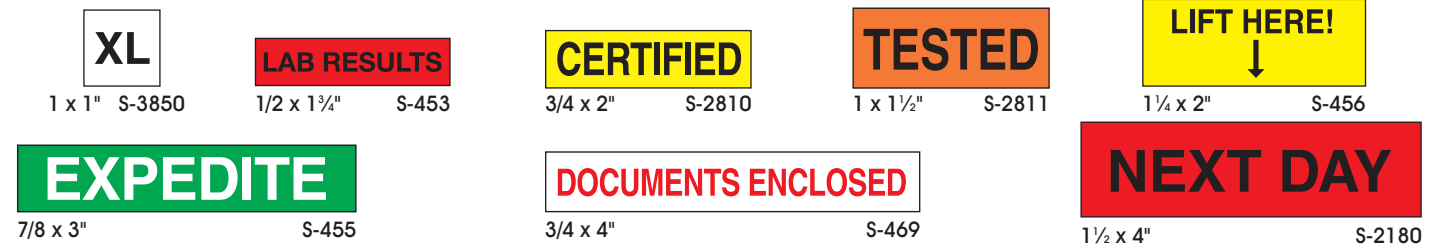

MODEL NO.	SIZE	PRICE PER 1,000					
		1	2	3	5	10	25+
S-6213	1/2 x 1"	\$52	\$42	\$35	\$25	\$19	\$17
S-2993	1/2 x 1 1/2"	55	48	40	30	24	22
S-453	1/2 x 1 3/4"	58	51	44	35	25	23
S-2810	3/4 x 2"	64	55	50	36	26	24
S-469	3/4 x 4"	121	104	90	64	42	37
S-455	7/8 x 3"	68	59	52	38	32	29

MODEL NO.	SIZE	PRICE PER 1,000					
		1	2	3	5	10	25+
S-3850	1 x 1"	\$57	\$50	\$42	\$31	\$24	\$22
S-2811	1 x 1 1/2"	64	55	50	36	26	24
S-6214	1 x 3"	69	62	53	39	35	25
S-456	1 1/4 x 2"	68	59	52	38	32	24
S-2994	1 1/4 x 3"	125	90	75	51	41	32
S-2180	1 1/2 x 4"	132	117	102	84	69	58

## TO ORDER YOUR CUSTOM PRINTED LABELS

**BY PHONE:** 1-800-295-5510 or **ONLINE:** Design, create and see your custom label at [uline.com/label](http://uline.com/label)

- 1. Choose Size**
- 2. Choose Label Stock** Gloss white, yellow; fluorescent red, yellow, orange, green, pink; gold or silver foil; litho (flat) white, blue, yellow. Removable adhesive available in select label stocks. Weatherproof available in vinyl: white, yellow and silver; or clear acetate.

- 3. Choose Ink Color** Black, blue, red or green. More colors available, see [uline.com](http://uline.com) (up to 2)
  - 4. Choose Type Style** *Park Avenue*, *Optima*, *Helvetica*, *Helvetica Bold*. See [uline.com](http://uline.com) for more options.
- RUSH SERVICE** 24 hr. service, add \$60. 48 hr. service, add \$40. Plus overnight shipping charges.

# CUSTOM PRINTED LABELS

SHIPS IN 5 WORKING DAYS



2 x 4" S-459



2 x 3" S-457



3 x 4" S-366



3 x 5" S-458



2 x 5" S-20741

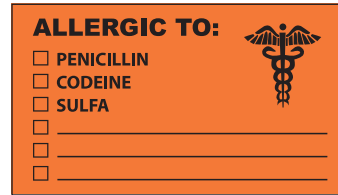

3 x 6" S-20742

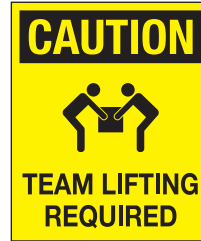

4 x 3" S-20743



4 x 6" S-462



5 x 7" S-2543



4 x 5" S-2807



8½ x 11" S-6208



6 x 8" S-20744

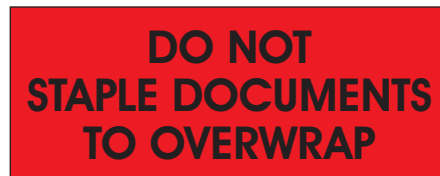

3 x 8" S-2181



6 x 10" S-2996

RUSH SERVICE AVAILABLE

MODEL NO.	SIZE	PRICE PER 1,000						
		1	2	3	5	10	25	30+
S-20740	2 x 1"	\$67	\$59	\$51	\$38	\$29	\$24	CALL FOR QUOTE
S-457	2 x 3"	80	66	61	57	40	29	
S-459	2 x 4"	87	78	69	61	44	36	
S-20741	2 x 5"	96	87	82	72	59	45	
S-366	3 x 4"	98	86	74	66	51	44	
S-458	3 x 5"	114	98	82	70	57	49	
S-20742	3 x 6"	140	126	111	104	89	80	
S-2181	3 x 8"	223	193	162	130	100	78	
S-20743	4 x 3"	98	86	74	66	51	44	
S-2807	4 x 5"	163	142	119	95	71	59	
S-462	4 x 6"	223	193	162	130	100	78	
S-2995	4 x 10"	311	271	203	172	138	112	
S-2543	5 x 7"	308	268	200	166	134	109	
S-20744	6 x 8"	323	283	215	185	151	124	
S-2996	6 x 10"	408	355	276	239	186	160	
S-6208	8½ x 11"	415	361	300	244	225	190	



4 x 10" S-2995

Removable Adhesive Available  
Call or visit: [uline.com](http://uline.com)

# CUSTOM PRINTED WEATHERPROOF LABELS



Resists rain, sun and grease for **1½ years** and still looks great.

- Recommended for drums, vehicles, tanks and outdoor items.

Colored vinyl and clear acetate labels are printed with fade-resistant inks and sealed with a polymer coating.

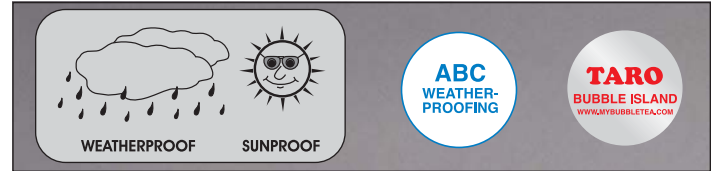

MODEL NO.	SIZE	QTY./ ROLL	PRICE PER ROLL		
			1	2	4+
S-13188	1 x 3"	250	\$139	\$89	\$62
S-14157	1¼ x 2"		145	91	63
S-15531	1½ x 3"		151	93	64
S-14158	1½ x 4"		158	96	65
S-22460	2 x 1"		136	87	60
S-5513	2 x 2"		145	91	63
S-5514	2 x 3"		149	95	64
S-5515	2 x 4"		157	97	66
S-15532	3 x 1"	250	139	89	62
S-14159	3 x 3"		160	98	67
S-5516	3 x 4"		162	99	68
S-11396	3 x 5"		198	125	84
S-20747	3 x 8"		257	163	108
S-22461	4 x 1"		152	92	65

MODEL NO.	SIZE	QTY./ ROLL	PRICE PER ROLL		
			1	2	4+
S-22462	4 x 2"	250	\$159	\$100	\$69
S-14160	4 x 4"		214	139	91
S-6209	4 x 5"		226	145	92
S-13189	4 x 6"		256	159	105
S-22463	4 x 8"		293	187	111
S-20748	5 x 5"		280	175	111
S-13190	5 x 7"		303	189	124
S-20749	6 x 10"		504	325	234
S-11397	8½ x 11"	607	378	254	
S-6210	1" Circle	250	141	89	59
S-5517	1½" Circle		145	91	63
S-5518	2" Circle		149	95	64
S-11398	3" Circle		163	104	70
S-17317	4" Circle		197	123	80

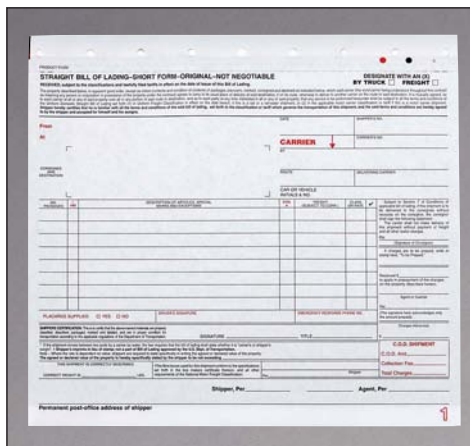

## BILL OF LADING

Accepted by all rail, motor and water carriers.

- Available in 3 or 4 part sets.
- Custom printing available, see [uline.com](http://uline.com)

CARBONLESS STYLE								
MODEL NO.	SIZE W x L	NO. FORMS	QTY./ CTN.	PRICE PER CARTON				
				1	2	4	8	12+
S-9619	8½ x 7"	3	250	\$46	\$44	\$42	\$39	\$36
S-9620		4		60	57	54	50	46

CARBON STYLE								
MODEL NO.	SIZE W x L	NO. FORMS	QTY./ CTN.	PRICE PER CARTON				
				1	2	4	8	12+
S-6665	8½ x 7"	3	250	\$42	\$40	\$38	\$35	\$32
S-6666		4		52	49	46	43	39

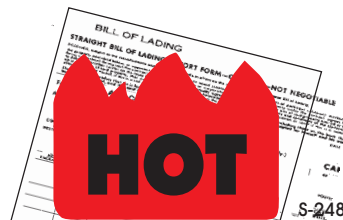

## BILL OF LADING LABELS

Brilliant fluorescent color gets "HOT" idea across instantly.



MODEL NO.	DESCRIPTION	SIZE	QTY./ ROLL	PRICE PER ROLL			
				1	5	10	25+
S-248	Hot	1½ x 2"	1,000	\$21	\$19	\$16	\$14
S-14168	Rush						
S-14169	Priority						



# ULINE LABEL DISPENSERS



**ECONOMY**



**DELUXE**



**WALL MOUNT**

**ECONOMY**

MODEL NO.	WORKING WIDTH	MAX. ROLL DIAM.	CORE DIAM.	PRICE EACH		
				1	2	6+
H-151	2"			\$27	\$25	\$24
H-153	4"			31	29	28
H-154	6"	5½"	1"	36	34	32
H-468	8"			41	39	37
H-155	10"			45	42	40
H-586	12"			52	50	48

**DELUXE**

H-17	11"	7"	1-3"	\$70	\$62	\$56
H-587	13"			74	66	60

**WALL MOUNT**

H-4689	2½"			\$62	\$59	\$54
H-4690	4"	7"	1-3"	66	62	56
H-4691	8"			69	66	60
H-4692	12"			74	70	65

**ECONOMY** – Keep your labels organized and easy to reach.

- Dispenser peels away backing and puts label at your fingertips for fast, easy removal.
- Holds 1" core labels (for 3" core adapter, see uline.com).

**DELUXE** – Specially designed to provide **greater stability** and to hold **larger rolls** – Up to 7" diameter.

- **Solid metal base:** no slipping and more stability on packing table.
- H-587 holds any combination of rolls up to 13" wide.
- Holds 1" core labels, includes adapter for 3" core labels.

**WALL MOUNT** – Unclutter your workspace.

- Solid metal frame and nonslip base.
- Versatile – Use on wall or tabletop.
- Save valuable space on your packing table.

## TAPE AND LABEL DISPENSERS

- H-675 and H-676 – Quick, easy loading. Change one roll at a time.
- H-129 and H-148 – American made. Low-profile design.

MODEL NO.	WORKING WIDTH	MAX. ROLL DIAM.	CORE DIAM.	PRICE EACH		
				1	2	6+
H-675	12"			\$80	\$75	\$70
H-676	18"	6"	1-3"	95	90	85
H-129	10"	6"	1-3"	145	140	135
H-148	18"			190	185	180



H-148

H-676

## AUTOMATIC LABEL DISPENSERS

High speed, low-maintenance dispensers for pressure-sensitive labels.

- Automatically advances, peels and releases labels from liner. Up to 7" per second.
- 115 volts. 4½' power cord.



**MADE IN USA LABELS**

Page 266



MODEL NO.	OVERALL DIM. L x W x H	MAXIMUM LABEL		MAX. ROLL DIAM.	CORE DIAM.	WEIGHT	PRICE EACH	
		WIDTH	LENGTH				1	2+
H-1276	10½ x 9½ x 8"	3/8 - 4"	3/4 - 6"	9"	1-3"	8 lbs.	\$610	\$590
H-1981	11½ x 9¾ x 8"	3/8 - 6"	3/4 - 12"			13 lbs.	660	640

# D.O.T. LABELS

## AIR SPECIALTY LABELS

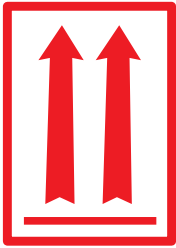

S-2851 3 x 4 1/4"  
S-607 4 x 6"

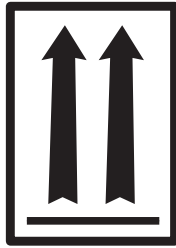

S-19286 3 x 4 1/4"



S-10798 2 1/2 x 6"



S-23840 2 x 5 1/2"



BIOLOGICAL SUBSTANCE, CATEGORY B

S-12521 4 3/4 x 4"



S-14590 4 7/8 x 4 3/4"

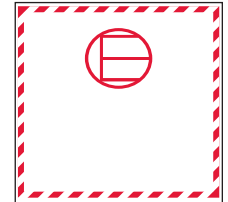

S-13730 4 7/8 x 4 1/8"

MODEL NO.	SIZE	QTY./ROLL	PRICE PER ROLL			
			1	2	5	20+
S-2851	3 x 4 1/4"	500	\$18	\$17	\$16	\$15
S-607	4 x 6"		38	33	29	28
S-19286	3 x 4 1/4"		18	17	16	15
S-10798	2 1/2 x 6"		37	31	27	26

MODEL NO.	SIZE	QTY./ROLL	PRICE PER ROLL			
			1	2	5	20+
S-23840	2 x 5 1/2"	500	\$38	\$33	\$29	\$28
S-12521	4 3/4 x 4"		33	31	27	24
S-14590	4 7/8 x 4 3/4"		35	32	28	25
S-13730	4 7/8 x 4 1/8"		29	26	22	21



## LIMITED QUANTITY LABELS

Identify limited quantity shipments of dangerous goods.

- Meets IMDG and D.O.T. requirements.

S-18718 2 1/4 x 2 1/4" S-18719 2 1/4 x 2 1/4"  
S-17371 4 1/4 x 4 1/4" S-17372 4 1/4 x 4 1/4"

MODEL NO.	SIZE	QTY./ROLL	PRICE PER ROLL		
			1	2	6+
S-18718 to S-18719	2 1/4 x 2 1/4"	500	\$18	\$16	\$15
S-17371 to S-17372	4 1/4 x 4 1/4"		34	29	26

## HAZMAT PAPER SHIPPING TABS

Ensure hazmat documents instantly grab attention in stacks of shipping papers.

- Comply with D.O.T. regulations. Flip directly to hazmat information and instructions.



MODEL NO.	SIZE	QTY./ROLL	PRICE PER ROLL		
			1	2	6+
S-23843	3/4 x 2"	500	\$30	\$26	\$23

## BATTERY LABELS



S-22084 4 1/2 x 5"



S-23262 4 1/2 x 5"



S-21767 2 x 4"



S-15764 2 x 4"



S-23263 4 1/2 x 5"



S-23839 2 x 4"

## LITHIUM

MODEL NO.	SIZE	QTY./ROLL	PRICE PER ROLL			
			1	2	5	20+
S-22084	4 1/2 x 5"	500	\$38	\$33	\$28	\$26
S-23262						
S-23263						

## FORBIDDEN FOR TRANSPORT

MODEL NO.	SIZE	QTY./ROLL	PRICE PER ROLL			
			1	2	5	20+
S-15764	2 x 4"	500	\$17	\$16	\$14	\$13
S-21767						
S-23839						



## KING PIN LOCKS

Prevents theft of dropped-off trailers.

- Covers semi-trailers' king pins. Prevents unauthorized coupling.
- Indestructible cast iron body. Cylinder lock and two keys.
- "Cup" design keeps grease off hands.



MODEL NO.	DESCRIPTION	PRICE EACH		
		1	6	12+
H-2224	Keyed Alike	\$41	\$39	\$37
H-2225	Keyed Different			



## TRAILER LOCKS

A safety product "from heaven."

- Prevents trailers from pulling out.
- Glad Hand Lock "deadlines" the emergency brake air line.
- Fits any emergency (red) brake air line.
- In use at all Uline docks.

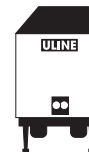

MODEL NO.	DESCRIPTION	PRICE EACH		
		1	3	6+
H-907	Keyed Alike	\$30	\$28	\$26
H-2226	Keyed Different			

# REGULATED LABELS

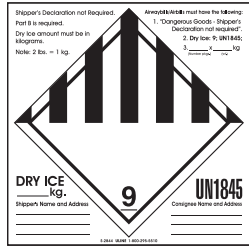

S-2844 Dry Ice 6 x 6"



S-3562 2 x 2"  
S-3336 4 x 4"  
S-20794 6 x 6"

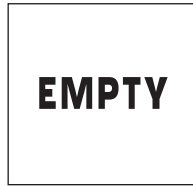

S-725 6 x 6"



S-15462 4 x 4"  
S-15463 Vinyl 10 1/4 x 10 1/4"

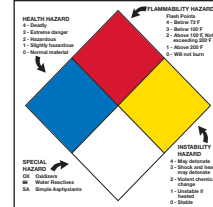

S-2845 2 x 2"  
S-724 4 x 4"

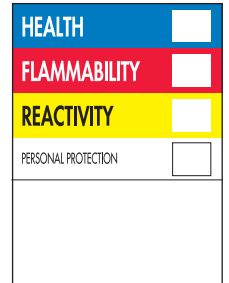

S-15699 2 x 3"  
S-2846 4 x 6"

MODEL NO.	SIZE	QTY./ ROLL	PRICE PER ROLL		
			1	2	6+
S-2844	6 x 6"	500	\$55	\$50	\$47
S-3562	2 x 2"		15	13	12
S-3336	4 x 4"		30	26	23
S-20794	6 x 6"		68	66	64
S-725	6 x 6"		55	50	47
S-15462	4 x 4"		31	27	24
S-15699	2 x 3"		24	21	19
S-2846	4 x 6"	49	44	41	

MODEL NO.	SIZE	QTY./ ROLL	PRICE PER ROLL		
			1	2	6+
S-2845	2 x 2"	500	\$17	\$15	\$14
S-724	4 x 4"		30	26	23
S-3533	2 x 2"	500	15	13	12
S-2889	4 x 4"		30	26	23

MODEL NO.	SIZE	QTY./ PKG.	PRICE PER PKG.		
			1	2	6+
S-15463	10 1/4 x 10 1/4"	100	\$78	\$73	\$69
S-2877	10 1/4 x 10 1/4"	10	22	20	18

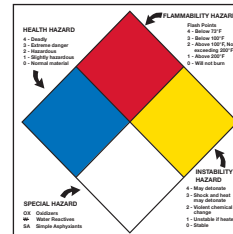

S-2877 Vinyl 10 1/4 x 10 1/4"

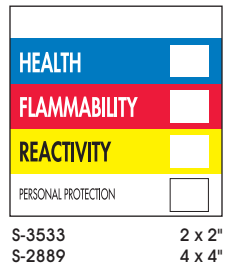

S-3533 2 x 2"  
S-2889 4 x 4"

## SUFFOCATION WARNING

**WARNING: TO AVOID DANGER OF SUFFOCATION, KEEP THIS PLASTIC BAG AWAY FROM BABIES AND CHILDREN. DO NOT USE THIS BAG IN CRIBS, BEDS, CARRIAGES OR PLAYPENS. THIS BAG IS NOT A TOY.**

**WARNING**  
Keep this bag away from babies and children. Do not use in cribs, beds, carriages or playpens. The thin film may cling to nose and mouth and prevent breathing.

**ATTENTION**  
Gardez ce sac hors de portée des bébés et enfants. Ne pas utiliser dans les berceaux, lits, poussettes ou parcs à bébé. Le film protecteur, étant fin, pourrait par inadvertance provoquer étouffement en bloquant les narines ou la bouche.

**ADVERTENCIA**  
Mantenga esta bolsa fuera del alcance de bebés y niños. No use en cunas, cunas, carriolas y cunas. La película delgada puede adherirse a nariz y boca e impedir la respiración.

**WARNING**  
**KEEP AWAY FROM SMALL CHILDREN. THE THIN FILM MAY CLING TO NOSE AND MOUTH AND PREVENT BREATHING.**

S-20795 24 pt. font 3 x 4 1/4" S-20796 2 3/4 x 5 1/4" S-8329 2 x 2"

MODEL NO.	SIZE	QTY./ ROLL	PRICE PER ROLL		
			1	2	6+
S-8329	2 x 2"	500	\$13	\$12	\$11
S-20795	3 x 4 1/4"		20	18	16
S-20796	2 3/4 x 5 1/4"		30	26	23

## CHOKING HAZARD

**WARNING: CHOKING HAZARD Small Parts.**  
Not for children under 3 years.

**WARNING: CHOKING HAZARD Small Parts.**  
Not for children under 5 years.

S-23841 1 x 1/2" S-23842 1 x 1/2"

MODEL NO.	SIZE	AGE LIMIT	QTY./ ROLL	PRICE PER ROLL		
				1	2	6+
S-23841	1 x 1/2"	Under 3	500	\$16	\$15	\$14
S-23842		Under 5				

## CALIFORNIA PROP 65

Stick warning labels to items that may contain chemicals known to cause cancer or reproductive harm.

MODEL NO.	SIZE	DESCRIPTION	QTY./ ROLL	PRICE PER ROLL		
				1	2	6+
S-22726	1 1/2 x 1/2"	Generic Nickel	500	\$11	\$10	\$9
S-23838		Lead				
S-23837		Full Generic				
S-23443	2 3/8 x 1 1/2"	Generic	500	16	14	13
S-23056	3 x 1"	Generic				

**WARNING: Cancer and Reproductive Harm - [www.P65Warnings.ca.gov](http://www.P65Warnings.ca.gov)**

S-22726 1 1/2 x 1/2" S-23056 3 x 1"

**CALIFORNIA PROPOSITION 65 WARNING**  
WARNING: This product contains chemicals known to the State of California to cause cancer and birth defects or other reproductive harm. For more information: [www.P65Warnings.ca.gov](http://www.P65Warnings.ca.gov)

S-23443 2 3/8 x 1 1/2"

**WARNING: Nickel - Cancer and Reproductive Harm [www.P65Warnings.ca.gov](http://www.P65Warnings.ca.gov)**

S-23838 1 1/2 x 1/2"

**WARNING: Lead - Cancer and Reproductive Harm [www.P65Warnings.ca.gov](http://www.P65Warnings.ca.gov)**

S-23837 1 1/2 x 1/2"

## WASTE

MODEL NO.	SIZE	DESCRIPTION	QTY./ ROLL	PRICE PER ROLL		
				1	2	6+
S-369	6 x 6"	Hazardous	500	\$69	\$67	\$65
S-352		Non-Hazardous				
S-13829		Universal				

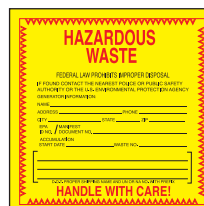

S-369 6 x 6"



S-352 6 x 6"



S-13829 6 x 6"



# D.O.T. LABELS



MODEL NO.	SIZE	QTY./ROLL	PRICE PER ROLL					
			1	2	4	8	10	20+
S-176 to S-22082	4 x 4" (100 x 100 mm)	500	\$29	\$25	\$24	\$23	\$22	\$21

- Labels can be combined for quantity pricing.
- Gloss paper with permanent adhesive.

# PRE-PRINTED D.O.T. LABELS

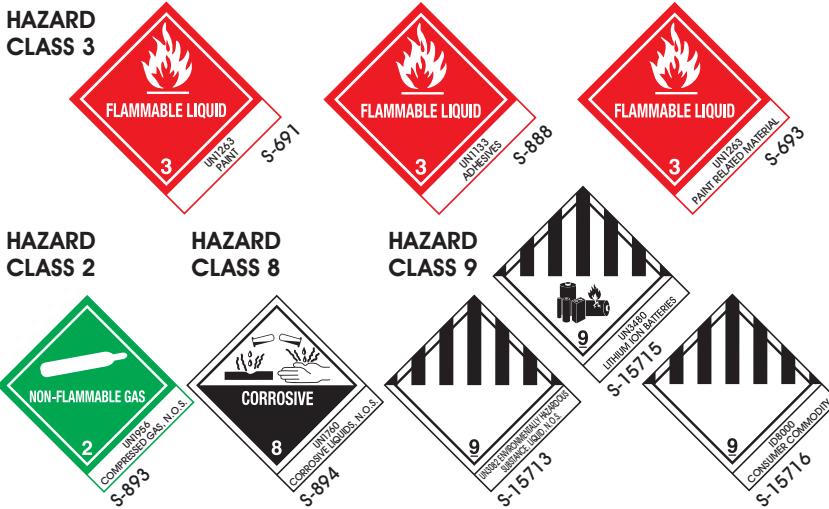

COMBINE LABELS FOR QUANTITY PRICING.  
COMPLETE LINE, SEE ULINE.COM

MODEL NO.	SIZE	QTY./ROLL	PRICE PER ROLL			
			1	2	6	12+
S-691 to S-15716	4 x 4 3/4"	500	\$34	\$29	\$26	\$24

MODEL NO.	SHIPPING NAME	LABEL	ID NO.
S-691	Paint	Flamm. Liquid	UN1263
S-888	Adhesives	Flamm. Liquid	UN1133
S-693	Paint Related Material	Flamm. Liquid	UN1263
S-893	Compressed Gas, N.O.S.	Non-Flamm. Gas	UN1956
S-894	Corrosive Liquids, N.O.S.	Corrosive	UN1760
S-15713	Env. Haz. Sub., Liquid, N.O.S.	Misc. Dangerous Goods	UN3082
S-15715	Lithium Ion Batteries		UN3480
S-15716	Consumer Commodity		ID8000

# GHS PICTOGRAM LABELS



S-21333	1 x 1"	S-21334	1 x 1"	S-21336	1 x 1"	S-21337	1 x 1"	S-21339	1 x 1"
S-21342	2 x 2"	S-21343	2 x 2"	S-21345	2 x 2"	S-21346	2 x 2"	S-21348	2 x 2"

Label hazardous products to meet OSHA's Globally Harmonized System (GHS) requirements.

- White, semi-gloss paper with permanent adhesive.
- Complete line, see uline.com

MODEL NO.	SIZE	QTY./ROLL	PRICE PER ROLL		
			1	2	6+
S-21333 to S-21339	1 x 1"	500	\$11	\$10	\$9
S-21342 to S-21348	2 x 2"		16	14	13

# D.O.T. TRUCK PLACARDS



Recommended for easy identification of hazardous loads.



- Flexible tagboard or strong, removable adhesive-backed vinyl.

MODEL NO.	DESCRIPTION	SIZE	PRICE PER 100	
			1	2+
Add "T" to model no. Add "V" to model no.	Poly-coated Tagboard Adhesive-backed Vinyl	10¾ x 10¾"	\$49 82	\$46 78
H-415	Tagboard Holder		\$18 each	

MODEL NO.	DESCRIPTION
S-20799	Explosives 1.4 S
S-1829	Flammable Gas
S-1830	Non-Flammable Gas
S-6128	Inhalation Hazard 2
S-2549	Oxygen
S-651	Flammable
S-654	Combustible
S-2553	Dangerous When Wet
S-2552	Flammable Solid
S-2554	Spont. Combustible

MODEL NO.	DESCRIPTION
S-2556	Oxidizer
S-14647	Organic Peroxide
S-8093	PG III
S-6129	Inhalation Hazard 6
S-2557	Poison
S-3572	Toxic
S-13908	Radioactive
S-653	Corrosive
S-2561	Misc. Dangerous Goods
S-652	Dangerous

## 4-DIGIT PLACARDS

MODEL NO.	MATERIAL DESCRIPTION	HAZARD CLASS	UN #
S-14648	Adhesives	Flammable Liquid	1133
S-14649	Ethyl Alcohol; Ethanol; Ethanol Solution	Flammable Liquid	1170
S-14650	Gasoline	Flammable Liquid	1203
S-11793	Paint	Flammable Liquid	1263
S-14651	Petroleum Distillates, N.O.S.	Flammable Liquid	1268
S-14652	Resin Solution	Flammable Liquid	1866
S-11794	Flammable Liquid, N.O.S. Fuel Oil	Flammable Liquid	1993
S-11795	Combustible Liquid, N.O.S.	Combustible Liquid	1993
S-11792	Corrosive Liquid, N.O.S.	Corrosive	1760
S-14654	Sodium Hydroxide Solution	Corrosive	1824
S-14655	Corrosive Liquid, Acidic, Inorganic, N.O.S.	Corrosive	3264
S-14656	Corrosive Liquid, Acidic, Organic, N.O.S.	Corrosive	3265
S-19567	Corrosive Liquid, Basic, Inorganic, N.O.S.	Corrosive	3266
S-14657	Env. Hazardous Substances, Solid, N.O.S.	Misc. Dangerous Goods	3077
S-14658	Env. Hazardous Substances, Liquid, N.O.S.	Misc. Dangerous Goods	3082



- Recommended for frequently transported hazardous materials by truck, rail or aircraft.
- Placard includes 4-digit UN #, hazard class graphic and corresponding class number.
- Additional 4-Digit Placards, see [uline.com](http://uline.com)

MODEL NO.	DESCRIPTION	SIZE	PRICE PER 100	
			1	2+
Add "T" to model no. Add "V" to model no.	Poly-coated Tagboard Adhesive-backed Vinyl	10¾ x 10¾"	\$49 82	\$46 78

MODEL NO.	DESCRIPTION	FLIP FILE LEGENDS	PRICE EACH	
			1	5+
H-55	8 Legend	Dangerous, Flammable Gas, Non-Flammable Gas, Flammable, Oxidizer, Inhalation Hazard 6, Poison, Corrosive.	\$44	\$41
H-472	15 Legend	Dangerous, Flammable Gas, Non-Flammable Gas, Inhalation Hazard 2, Flammable, Combustible, Spontaneously Combustible, Flammable Solid, Dangerous When Wet, Oxidizer, PG III, Inhalation Hazard 6, Poison, Corrosive, Miscellaneous Dangerous Goods.	68	63
H-2242	Digit-Flip 8 Legend	Flammable, Combustible (white bottom), Inhalation Hazard 2, Oxidizer, Inhalation Hazard 6, Poison, Corrosive, Miscellaneous Dangerous Goods. Plus All White Panel.	68	63

## D.O.T. FLIP FILE

- Long-lasting aluminum placards mount easily to trucks.
- Size: 13¾ x 13¾".
- Digit-Flip Placard provides any 4-digit combination.





## PULL-UP SEALS

Seal carts and security containers.

- Pulls tight – Lids stay locked on.
- Side tear-off for easy removal.
- For small sealing apertures.
- Consecutively numbered.

SPECIFY COLOR: Blue, Red, Green or Yellow

MODEL NO.	SIZE	BREAKING STRENGTH	PRICE PER 100		
			1	2	5+
S-13674	6"	25 lbs.	\$32	\$29	\$26
S-13675	8"		35	32	29
S-13676	10"		37	34	31



## PLASTIC TRUCK SEALS

Polypropylene strap blushes to show evidence of tampering.

- Double-click locking mechanism for enhanced security.
- Consecutively numbered.

SPECIFY COLOR: Red, Blue, Green or Yellow

MODEL NO.	SIZE	BREAKING STRENGTH	PRICE PER PACKAGE		
			300	1,000	2,000+
S-13677	3/8 x 8"	30 lbs.	\$45	\$104	\$173

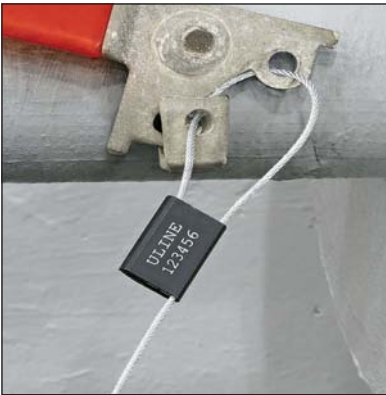

## COLORED CABLE SEALS

Protect your most valuable shipments.

- Galvanized steel aircraft cable frays when cut.
- Consecutively numbered.
- S-15562 is ideal for sealing tankers and railcars.
- Extra long S-15563 for sealing keeper bars on containers and trailers.

SPECIFY COLOR: Black, Blue or Red

MODEL NO.	SIZE	BREAKING STRENGTH	PRICE PER 50		
			1	4	10+
S-13699	1/16 x 12"	700 lbs.	\$69	\$65	\$59
S-13700	1/8 x 12"	2,400 lbs.	79	75	69
S-15562	1/8 x 24"	2,400 lbs.	99	95	89
S-13701*	3/16 x 12"	3,400 lbs.	129	119	109
			PRICE PER 20		
S-19192*	1/8 x 48"	2,400 lbs.	\$59	\$55	\$49
S-15563*	3/16 x 76"	3,400 lbs.	119	109	99



S-13700, S-15562, S-13701, S-19192 and S-15563 are C-TPAT and ISO 17712 compliant.

\* Only available in Black

## CONSPICUITY TAPE



Avoid dangerous nighttime collisions. Reflects light up to 90°.

**3M Diamond Grade** – Extra thick and bright. Rated for 7 years' use.

**Uline** – Low profile resists edge lift. Pre-cut strips or rolls.

- Red/White rated for 5 years' use.
- White and Yellow rated for 10 years' use.

FHWA law states all trailers must be marked with reflective tape.



### 3M ROLLS

Meets DOT-C2 and FMVSS 108 requirements

MODEL NO.	DESCRIPTION	MIL	PRICE EACH	
			1	2+
S-6735	2" x 150' Roll Red/White	13	\$206	\$191
S-6736	2" x 150' Roll White			

### ULINE ROLLS AND STRIPS

\* Meets DOT-C2 and FMVSS 108 requirements

MODEL NO.	DESCRIPTION	MIL	PRICE EACH	
			1	2+
S-19276*	2" x 150' Roll Red/White	6.5	\$114	\$104
S-23667*▲	2 x 12" Strips White	6.5	100	89
S-23668*▲	2 x 18" Strips Red/White		126	116
S-23669▲	4 x 18" Strips Yellow		278	252

▲ 100/pk.



# TRUCK SEALS

## PLASTIC TAMPER-RESISTANT



- Seals are consecutively numbered and laser printed with either "ULINE" or your custom wording (up to 17 spaces).
- Self-locking seal. • Breaking strength is 55 lbs.



**ULINE PLASTIC SEALS:** Min. order of 300. \*SPECIFY COLOR: Red, Black, Green, Blue, White, Yellow or Orange

MODEL NO.	DESCRIPTION	SIZE W x L	SHPG. WT.	PRICE PER PACKAGE			
				300	500	1,000	2,000+
H-543*	Plastic Colored	3/8 x 7 1/2"	9 lbs.	\$55	\$68	\$126	\$205

**CUSTOM WORDING:** Min. order of 1,000. Allow 4 weeks. 1,000 2,000 5,000 10,000+

H-436*	Plastic Colored	3/8 x 7 1/2"	9 lbs.	\$236	\$414	\$575	\$900
--------	-----------------	--------------	--------	-------	-------	-------	-------

## METAL TAMPERPROOF



- Ball lock protection. Impossible to reseal once broken.
- All seals are consecutively numbered. Seals embossed with "ULINE" or your custom wording (up to 17 spaces).

**ULINE METAL SEALS:** Min. order of 300. \*SPECIFY COLOR: Yellow, White, Blue or Red

MODEL NO.	DESCRIPTION	SIZE W x L	SHPG. WT.	PRICE PER PACKAGE			
				300	500	1,000	2,500+
H-541	Metal Silver	3/8 x 8 1/16"	15 lbs.	\$90	\$130	\$240	\$450
H-542*	Metal Colored			105	150	270	525

**CUSTOM WORDING:** Min. order of 1,000. Allow 6-8 weeks. 1,000 2,000 3,000 4,000+

H-346	Metal Silver	3/8 x 8 1/16"	15 lbs.	\$415	\$740	\$930	\$1,140
H-414*	Metal Colored			465	860	1,080	1,320



## HIGH SECURITY SEALS CLASSIFIED BY U.S. CUSTOMS AS HIGH SECURITY

Lock your high-value cargo up tight.

- Absolute protection from tampering and theft.
- Sequentially numbered on both bolt and body.
- ISO 17712 and C-TPAT compliant.
- Barcoded seals, see [uline.com](http://uline.com)

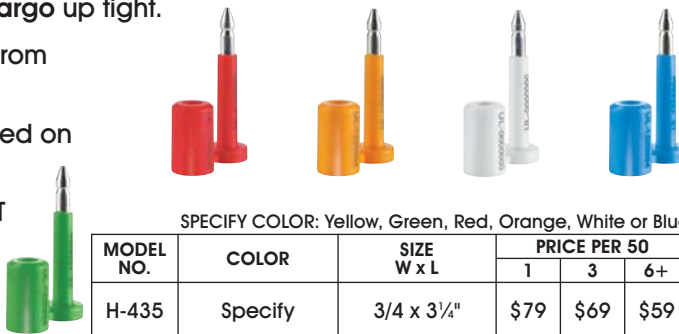

SPECIFY COLOR: Yellow, Green, Red, Orange, White or Blue

MODEL NO.	COLOR	SIZE W x L	PRICE PER 50		
			1	3	6+
H-435	Specify	3/4 x 3 1/4"	\$79	\$69	\$59



## BOLT CUTTERS

MODEL NO.	SIZE	CUTS THICKNESS	SHIPPING WEIGHT	PRICE EACH		
				1	2	5+
H-633	24"	3/8"	7 lbs.	\$70	\$68	\$66
H-1342	36"	5/8"	12 lbs.	105	100	95

- Use on truck seals, chain, wire and bolts.
- Heavy duty quality cutters.



# TUG-TIGHTS™



Prevent tampering on drums, tanks and bags.

- Breaking strength is **50 lbs.**
- Pulls tight – Lids stay locked on.
- **Consecutively numbered** for easy tracking.
- Custom printing available, see [uline.com](http://uline.com)

SPECIFY COLOR: White, Red, Orange, Yellow, Green, Blue or Black

MODEL NO.	LENGTH	BREAKING STRENGTH	PRICE PER 100		
			1	5	10+
H-609	9"	50 lbs.	\$38	\$36	\$34
H-610	12"		41	39	36
H-1344	15"		43	41	38
H-1345	18"		45	43	40



## HEAVY DUTY PLASTIC SEALS



Incredibly tough. **140 lb.** breaking strength.

- Recommended for bulk bags, railcars, drums, valves and trucks.
- Nail grip secures seal to bags.
- Long adjustable seals **consecutively numbered**.

SPECIFY COLOR: Blue, Red or Green

MODEL NO.	SIZE W x L	BREAKING STRENGTH	PRICE PER 100		
			1	2	5+
H-2223	3/8 x 14"	140 lbs.	\$37	\$34	\$32
H-917	3/8 x 20"	150 lbs.	49	46	44

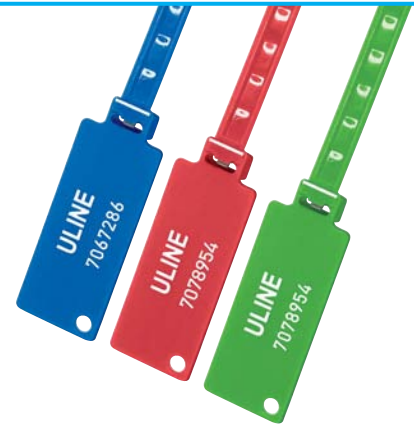

## EASY LOCK SEALS

**NO TOOLS REQUIRED**

Seal tool boxes, totes and drums.

- Snaps closed. Twists to open.
- Consecutively numbered.
- Patented hinge springs open if tampering occurs.

SPECIFY COLOR: ■ Red ■ Blue

MODEL NO.	LENGTH	BREAKING STRENGTH	PRICE PER 1,000		
			1	3	6+
H-1186	2"	10 lbs.	\$119	\$109	\$99



## PADLOCK SEALS

Secure utility meters, cabinets and drums.

- **100 lb.** breaking strength.
- **Wire cutter** needed to cut solid steel hasp.
- Consecutively numbered for easy tracking.

SPECIFY COLOR: ■ Yellow ■ Green ■ Red ■ Blue

MODEL NO.	LENGTH	BREAKING STRENGTH	PRICE PER 1,000		
			1	2	5+
H-916	2½"	100 lbs.	\$185	\$175	\$165



## CABLE SEALS

Secure your truck and railcar latches.

- Made with heavy-duty steel aircraft cable.
- Metal body is sequentially numbered.

C-TPAT AND ISO 17712 COMPLIANT

MODEL NO.	SIZE W x L	BREAKING STRENGTH	PRICE PER 50		
			1	2	5+
H-1346	1/8 x 12"	3,000 lbs.	\$99	\$96	\$93



## CABLE CUTTERS

Safely cut up to 1/4" cable with these pocket-sized cutters.

- Cut soft wire rope, piano wire or steel cable.
- Heavy-duty steel construction.

MODEL NO.	SIZE	SHIPPING WEIGHT	PRICE EACH		
			1	2	5+
H-1343	7½"	1 lb.	\$45	\$43	\$40

# ULINE TYVEK® TAGS

## WHITE

The toughest, most durable tag on the market.

- Tear-proof, weatherproof and chemical resistant.
- Low lint content – Ideal for sterile environments.

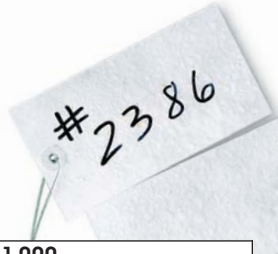

MODEL NO.	SIZE		PRICE PER 1,000			
			1	2	5	10+
S-5983	2¼ x 1¾"	#1	\$73	\$70	\$66	\$62
S-2020	3¼ x 1½"	#2	76	73	69	65
S-3835	3¼ x 1¾"	#3	79	76	72	68
S-2022	4¼ x 2½"	#4	82	79	75	71
S-2024	4¼ x 2½"	#5	86	83	79	74
S-2026	5¼ x 2½"	#6	93	89	83	77
S-3946	5¼ x 2½"	#7	113	107	100	92
S-2028	6¼ x 3½"	#8	118	113	106	98

PRE-WIRED TAGS: Add \$22 per 1,000 tags and add "PW" to model #.

## COLORS

Color code your items with tear-proof Tyvek®.

- 3/16" metal eyelet.
- Custom colors and printing available. Please call for a quote.

SPECIFY COLOR: Green, Yellow, Red, Orange or Blue

MODEL NO.	SIZE		PRICE PER 100			
			1	2	5	10+
S-5984	2¼ x 1¾"	#1	\$33	\$31	\$29	\$27
S-5985	3¼ x 1½"	#2	35	33	31	29
S-5986	3¼ x 1¾"	#3	37	35	33	31
S-5987	4¼ x 2½"	#4	39	37	35	33
S-3552	4¼ x 2½"	#5	40	38	36	34
S-5988	5¼ x 2½"	#6	44	42	40	37
S-5989	5¼ x 2½"	#7	51	49	47	44
S-3553	6¼ x 3½"	#8	54	51	48	45

PRE-WIRED AVAILABLE: Add \$3 per 100 tags and add "PW" to model #.



## SELF-LAMINATING TAGS

Clear overlay protects writing on tag from dirt, grease, moisture and alterations.

- Lift overlay, write message, peel off liner and press overlay over tag.
- Tough 10 mil vinyl. • Metal reinforced eyelet.

SPECIFY COLOR: Red, Green, White or Yellow

MODEL NO.	SIZE	STOCK	PRICE PER 100				
			1	2	5	10+	
S-15226	4¼ x 2½"	#5	10 Mil	\$62	\$55	\$49	\$44
S-15227	6¼ x 3½"	#8		72	67	60	53



## VINYL TAG PROTECTORS

Color coded to call attention to rejected items, low inventory or repair needs.

- 8 mil clear vinyl protects tags from harsh environments.
- Use on machinery, valves, controls, switches, etc.

SPECIFY COLOR: Clear, Yellow, Red, Dark Blue or Green Flap

MODEL NO.	SIZE W x L	SUGGESTED USE	PRICE PER CARTON OF 50		
			1	3	6+
S-7249	2½ x 4¾"	#5 Tag	\$34	\$32	\$30
S-7250	3½ x 6¼"	#8 Tag	42	40	37
S-12436	4 x 6"	Photos	43	41	39
S-7251	4 x 8"	#12 Tag	44	42	40
S-10503	6 x 9"	Manuals	62	59	56
S-7716	9 x 12"	Forms	71	67	63



JOB TICKET HOLDERS PAGES 646-647



# ULINE FLUORESCENT TAGS



**13 POINT STOCK**

MODEL NO.	COLOR	SIZE	STOCK	PRICE PER 1,000				
				1	2	5	10+	
S-5978	Specify Color: Orange, Green, Pink, Yellow or Red	2¼ x 1⅜"	#1	13 Point	\$48	\$44	\$41	\$38
S-5979		3¼ x 1⅝"	#2		50	46	43	40
S-5980		3¾ x 1⅞"	#3		52	48	45	42
S-5981		4¼ x 2⅞"	#4		54	50	47	44
S-2236		4¾ x 2⅞"	#5		60	55	50	46
S-3945		5¼ x 2⅞"	#6		67	61	55	49
S-5982		5¾ x 2⅞"	#7		83	76	69	62
S-2237		6¼ x 3⅞"	#8		85	78	71	64

Eye-catching colors call attention where needed.

- 13 point, heavy-duty paper stock.
- **ORANGE:** Flag special handling instructions.
- **GREEN:** Call attention to operating instructions.
- **PINK:** Signal low inventory.
- **YELLOW:** For poorly lit areas. Tag, locate, identify.
- **RED:** Highlight danger or warning messages.

**PRE-WIRED TAGS:** Add \$22/1,000 tags and add "PW" to model #.

**PRE-STRUNG TAGS:** Add \$22/1,000 tags and add "PS" to model #.

## PLASTIC TAGS

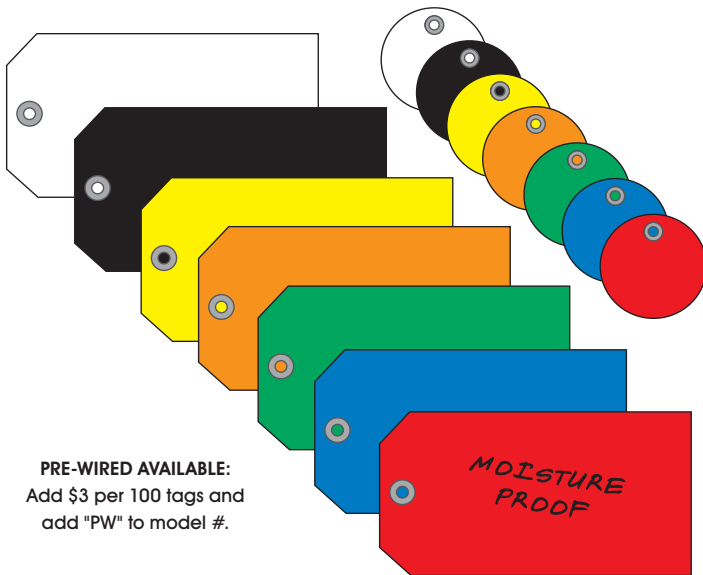

**PRE-WIRED AVAILABLE:**  
Add \$3 per 100 tags and add "PW" to model #.

**TEAR-PROOF**

### PLASTIC TEAR-PROOF

Tough, durable and ideal for harsh indoor/outdoor conditions.

- Waterproof, good for damp or wet areas.
- Color code inventory and equipment.
- Metal eyelet.



SPECIFY COLOR: White, Black, Yellow, Orange, Green, Blue or Red

MODEL NO.	SIZE	STOCK	QTY./BUNDLE	PRICE PER BUNDLE		
				1	2	5+
S-5544	4¼ x 2⅞" #5	10 Mil	100	\$34	\$32	\$29
S-10749	6¼ x 3⅞" #8			45	43	40

### CIRCLES

S-12329	2" Circles	10 Mil	100	\$32	\$30	\$27
S-7219	3" Circles			34	32	29

## TAG FASTENERS

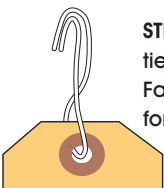

**STRING** – Loop or tie to attach tag. Fast and flexible for shipping tags.

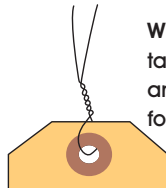

**WIRE** – Twist to secure tag to item. Durable and reusable, perfect for inventory control.

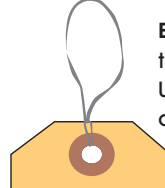

**ELASTIC** – Pre-tied. Loop through itself to secure. Used often for repairs and furniture.

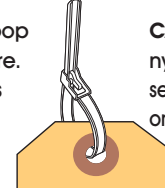

**CABLE TIE** – Tough nylon tie attaches securely to machinery or products.

MODEL NO.	SIZE	PRICE PER 1,000			
		1	2	5	10+
S-921	12" String	\$19	\$18	\$17	\$16
S-920	12" Wire	15	14	13	12

MODEL NO.	SIZE	PRICE PER 1,000			
		1	2	5	10+
S-10750	9" Elastic Loop	\$29	\$28	\$27	\$26
S-1021	8" Cable Tie	<b>\$34 per 1,000 any quantity</b>			

# ULINE SHIPPING TAGS

## MANILA

Identify and tag items that won't easily hold a shipping label for delivery.

- Heavy-duty **13 point** stock.
- Reinforced 1/4" paper eyelet resists tearing.

MODEL NO.	SIZE	STOCK	PRICE PER 1,000			
			1	2	5	10+
S-1474	2 3/4 x 1 3/8" #1	<b>13 Point</b>	\$30	\$28	\$26	\$24
S-930	3 1/4 x 1 5/8" #2		33	31	29	26
S-1151	3 3/4 x 1 7/8" #3		36	34	31	28
S-1475	4 1/4 x 2 1/8" #4		40	37	33	30
<b>S-931</b>	<b>4 3/4 x 2 3/8" #5</b>		<b>\$31 per 1,000 any quantity</b>			
S-1152	5 1/4 x 2 5/8" #6		47	44	40	35
S-2965	5 3/4 x 2 7/8" #7		55	51	47	42
S-932	6 1/4 x 3 1/8" #8		64	59	52	47

### JUMBO SHIPPING TAGS

MODEL NO.	SIZE	STOCK	PRICE PER 500			
			1	2	5	10+
S-2408	7 1/2 x 3 3/4" #11	<b>15 Point</b>	\$68	\$64	\$58	\$52
S-2409	8 x 4" #12	<b>Point</b>	74	68	62	55

## COLORS

- Create a color code system for shipments and inventory.
- Specify Yellow, Red, Green, Orange, White, Blue, Light Blue or Pink. Gray and Purple available only in #5, #6 and #8.

SPECIFY COLOR

MODEL NO.	SIZE	STOCK	PRICE PER 1,000			
			1	2	5	10+
S-2410	2 3/4 x 1 3/8" #1	<b>13 Point</b>	\$39	\$36	\$33	\$29
S-2411	3 1/4 x 1 5/8" #2		41	38	35	31
S-2412	3 3/4 x 1 7/8" #3		43	40	37	33
S-2413	4 1/4 x 2 1/8" #4		46	43	39	35
<b>S-2414</b>	<b>4 3/4 x 2 3/8" #5</b>		<b>\$37 per 1,000 any quantity</b>			
S-2415	5 1/4 x 2 5/8" #6		57	53	48	43
S-2416	6 1/4 x 3 1/8" #8		71	66	60	53

### COLOR JUMBO SHIPPING TAGS

MODEL NO.	SIZE	STOCK	PRICE PER 500			
			1	2	5	10+
S-5975	8 x 4" #12	<b>15 Point</b>	\$83	\$77	\$71	\$64

## ASSORTED PACKS

- Pack includes 200 of each: Red, Blue, Green, Yellow and Orange.

MODEL NO.	SIZE	STOCK	PRICE PER 1,000			
			1	2	5	10+
S-15229	4 3/4 x 2 3/8" #5	<b>13 Point</b>	\$67	\$63	\$58	\$51
S-15230	6 1/4 x 3 1/8" #8		89	82	76	70

## WIRE AND STRING TIES

MODEL NO.	SIZE	PRICE PER 1,000			
		1	2	5	10+
S-920	12" Wire	\$15	\$14	\$13	\$12
S-921	12" String	19	18	17	16

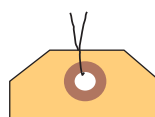
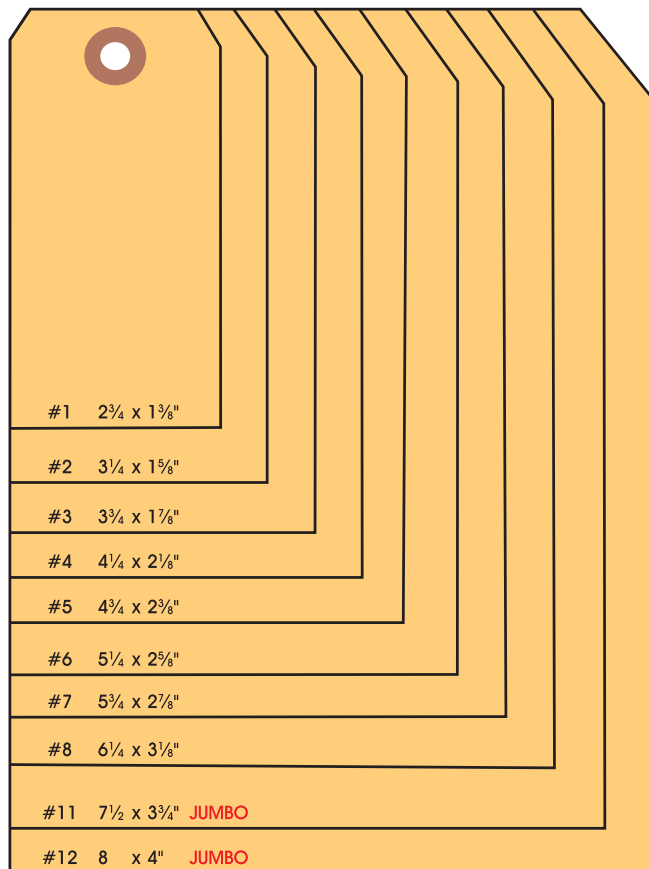

PRE-WIRED TAGS

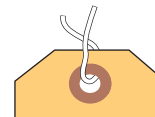

PRE-STRUNG TAGS

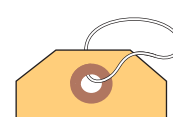

PRE-TIED ELASTIC TAGS

**PRE-WIRED TAGS:** Add \$22/1,000 tags and add "PW" to model #.

**PRE-STRUNG TAGS:** Add \$22/1,000 tags and add "PS" to model #.

**PRE-TIED ELASTIC TAGS:** Add \$28/1,000 tags and add "PE" to model #. Manila only.

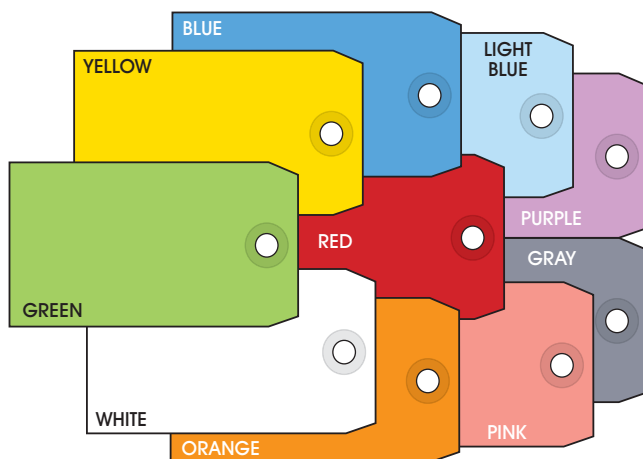

Attach tags to products with wire or string ties.



# CUSTOM PRINTED TAGS

## MANILA

- Heavy-duty 13 pt. stock.
- 1/4" paper eyelet.
- Additional sizes available.



MODEL NO.	SIZE	PRICE PER 1,000			
		1	3	5	10+
S-6024	2 1/4" x 1 1/8" #1	\$194	\$158	\$114	\$65
S-6025	3 1/4" x 1 1/8" #2	199	162	117	67
S-6026	3 3/4" x 1 1/8" #3	203	165	119	69
S-6027	4 1/4" x 2 1/8" #4	210	171	121	71
S-6028	4 3/4" x 2 1/8" #5	112	97	82	73
S-6029	5 1/4" x 2 1/8" #6	221	181	127	79
S-6030	5 3/4" x 2 1/8" #7	228	186	133	82
S-6031	6 1/4" x 3 1/8" #8	132	116	95	87
S-6032*	8" x 4" #12	N/A	N/A	165	121

\* 15 pt. stock

## COLORS

- Heavy-duty 13 pt. stock.
- Specify Yellow, Red, Green, White, Blue, Light Blue, Gray, Orange or Pink.

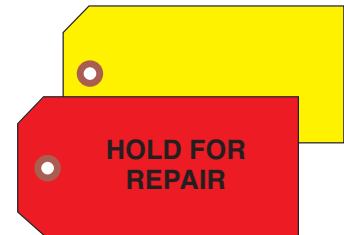

MODEL NO.	SIZE	PRICE PER 1,000			
		1	3	5	10+
S-6041	2 1/4" x 1 1/8" #1	\$204	\$165	\$120	\$68
S-6042	3 1/4" x 1 1/8" #2	208	170	122	70
S-6043	3 3/4" x 1 1/8" #3	213	173	124	72
S-6044	4 1/4" x 2 1/8" #4	220	180	126	75
S-6045	4 3/4" x 2 1/8" #5	226	186	130	77
S-6046	5 1/4" x 2 1/8" #6	232	190	135	82
S-6047	5 3/4" x 2 1/8" #7	239	194	139	87
S-6048	6 1/4" x 3 1/8" #8	248	198	143	92
S-6049*	8" x 4" #12	N/A	N/A	173	126

\* 15 pt. stock

## FLUORESCENT

- Heavy-duty 13 pt. stock.
- Brilliant fluorescent paper.
- Specify Fluorescent Orange, Green, Pink, Yellow or Red.

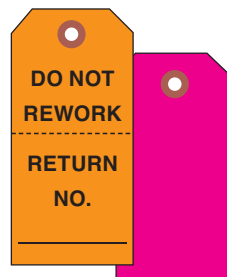

MODEL NO.	SIZE	PRICE PER 1,000			
		1	3	5	10+
S-6033	2 1/4" x 1 1/8" #1	\$221	\$175	\$126	\$76
S-6034	3 1/4" x 1 1/8" #2	229	180	131	78
S-6035	3 3/4" x 1 1/8" #3	239	185	135	80
S-6036	4 1/4" x 2 1/8" #4	249	191	137	82
S-6037	4 3/4" x 2 1/8" #5	262	198	140	85
S-6038	5 1/4" x 2 1/8" #6	278	206	146	91
S-6039	5 3/4" x 2 1/8" #7	293	216	152	95
S-6040	6 1/4" x 3 1/8" #8	309	228	156	100

## MULTI-PART TAGS

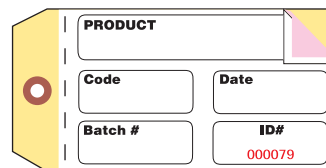

CONSECUTIVE NUMBERING INCLUDED

### 3-PART CARBONLESS

- 2-part tag has 15# bond paper on 10 pt. manila.
- 3-part includes one pink sheet in center.

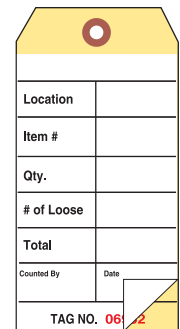

### 2-PART CARBONLESS

### 2-PART CARBONLESS

MODEL NO.	SIZE	DESCRIPTION	PRICE PER 1,000		
			5	10	15+
S-7244	6 1/4" x 3 1/8" #8	2-part	\$239	\$172	\$154
S-7245	6 1/4" x 3 1/8" #8	2-part w/ adhesive	342	232	211

### 3-PART CARBONLESS

S-7246	6 1/4" x 3 1/8" #8	3-part	\$293	\$206	\$188
--------	--------------------	--------	-------	-------	-------

## TYVEK®

- Metal 1/4" eyelet.
- Heavier gauge wire is available. Please contact Uline for a quote.
- Colored Tyvek® – Call attention to your important shipments.



### WHITE TYVEK®

MODEL NO.	SIZE	PRICE PER 1,000			
		1	3	5	10+
S-6050	2 1/4" x 1 1/8" #1	\$248	\$201	\$152	\$106
S-6051	3 1/4" x 1 1/8" #2	255	210	164	118
S-6052	3 3/4" x 1 1/8" #3	257	213	167	121
S-6053	4 1/4" x 2 1/8" #4	262	217	173	126
S-6054	4 3/4" x 2 1/8" #5	266	225	180	129
S-6055	5 1/4" x 2 1/8" #6	284	238	190	136
S-6056	5 3/4" x 2 1/8" #7	313	256	201	144
S-6057	6 1/4" x 3 1/8" #8	336	274	211	156

### COLORED TYVEK® SPECIFY COLOR: Green, Red, Yellow, Blue or Orange

S-10760	5 1/4" x 2 1/8" #6	\$459	\$383	\$307	\$224
S-10761	6 1/4" x 3 1/8" #8	526	434	342	257

## TO ORDER YOUR CUSTOM PRINTED TAGS:

2 WEEK LEAD TIME AFTER PROOF APPROVAL

### 1. INK COLORS:

Black Red Blue Green  
2 Ink Colors: Add \$24 per 1,000 (1-sided only).

### 2. TYPE STYLES:

Helvetica, Calibri, Optima, Times New Roman.

### 3. PLATE CHARGES:

\$25 per side. \$25 per ink color. \$35 for 2-part, \$45 for 3-part.

### PRE-WIRED, PRE-STRUNG:

Add \$22 per 1,000 and add "PW" or "PS" to model #.

## OPTIONS ALSO AVAILABLE:

### 2-SIDED PRINTING

Add \$24 per 1,000 (for 1-part).

### CONSECUTIVE #S

1,000: Add \$36/M. 5,000+: Add \$10/M. 1-part forms with perforation available. Choose Black or Red.

### ARTWORK

Upload custom artwork or email to [customdepartment@uline.com](mailto:customdepartment@uline.com)





# INVENTORY TAGS

#8 TAGS

2-Part Carbonless

3-Part Carbonless

**PRE-WIRED:** Add \$22/1,000 and "PW" to model #.

**ADHESIVE BACKED:** Add \$22/1,000 and "-A" to model #. Available for 0000-6999 only.

## CARBONLESS

Help keep your inventory under control with sequentially pre-numbered 6¼ x 3⅛", #8 tags.

- Carbonless – Copies without messy papers.
- Perforated – Bottom sheet stays with product.
- **TWO-PART** – Available up to 19,999 on uline.com

### Two-Part Carbonless

MODEL NO. / NUMBER SEQUENCE						500 PER CTN.	
						PRICE/CTN.	
		1	5+				
S-2937	0000-0499	S-6452	3500-3999	S-6459	7000-7499	\$52	\$44
S-3964	0500-0999	S-6453	4000-4499	S-6460	7500-7999		
S-5588	1000-1499	S-6454	4500-4999	S-6461	8000-8499		
S-5589	1500-1999	S-6455	5000-5499	S-6462	8500-8999		
S-5590	2000-2499	S-6456	5500-5999	S-6463	9000-9499		
S-5591	2500-2999	S-6457	6000-6499	S-6464	9500-9999		
S-6451	3000-3499	S-6458	6500-6999	S-6465	10000-10499		

### Three-Part Carbonless

MODEL NO. / NUMBER SEQUENCE						500 PER CTN.	
						PRICE/CTN.	
		1	5+				
S-2938	0000-0499	S-6467	3500-3999	S-6474	7000-7499	\$71	\$64
S-3965	0500-0999	S-6468	4000-4499	S-6475	7500-7999		
S-5592	1000-1499	S-6469	4500-4999	S-6476	8000-8499		
S-5593	1500-1999	S-6470	5000-5499	S-6477	8500-8999		
S-5594	2000-2499	S-6471	5500-5999	S-6478	9000-9499		
S-5595	2500-2999	S-6472	6000-6499	S-6479	9500-9999		
S-6466	3000-3499	S-6473	6500-6999	S-6480	10000-10499		

## CARBON STYLE

- **TWO-PART** – Printed front and back. Adhesive strip on base ply.
- **THREE-PART** – Blank multi-purpose tags.
- Sequentially numbered.

### Two-Part with Adhesive Strip and Carbon

MODEL NO. / NUMBER SEQUENCE						500 PER CTN.	
						PRICE/CTN.	
		1	5+				
S-5976	0000-0499	S-7227	2000-2499	S-7231	4000-4499	\$105	\$98
S-7224	0500-0999	S-7228	2500-2999	S-7232	4500-4999		
S-7225	1000-1499	S-7229	3000-3499	S-14007	5000-5499		
S-7226	1500-1999	S-7230	3500-3999	S-14008	5500-5999		

### Three-Part Blank with Carbon

MODEL NO. / NUMBER SEQUENCE						500 PER CTN.	
						PRICE/CTN.	
		1	5+				
S-5977	0000-0499	S-14009	0500-0999	S-14010	1000-1499	\$98	\$86

**PRE-WIRED:** Add \$22/1,000 and "PW" to model #.

2-Part with Adhesive Strip and Carbon

3-Part Blank with Carbon

## STUB STYLE

Recommended for tracking inventory and recording repairs.

- **ONE-PART** – Consecutively numbered on body and perforated stub.
- **TWO-PART** – Includes numbering on stub, base and top plies. Carbonless.

### One-Part Stub Style

MODEL NO. / NUMBER SEQUENCE						1,000 PER CTN.	
						PRICE/CTN.	
		1	5+				
S-2936	0000-0999	S-6445	3000-3999	S-6448	6000-6999	\$60	\$53
S-5584	1000-1999	S-6446	4000-4999	S-6449	7000-7999		
S-5585	2000-2999	S-6447	5000-5999	S-6450	8000-8999		

### Two-Part Stub Style – Carbonless

MODEL NO. / NUMBER SEQUENCE						500 PER CTN.	
						PRICE/CTN.	
		1	5+				
S-7233	0000-0499	S-7237	2000-2499	S-7240	3500-3999	\$54	\$46
S-7234	0500-0999	S-7238	2500-2999	S-7241	4000-4499		
S-7235	1000-1499	S-7239	3000-3499	S-7242	4500-4999		

**PRE-WIRED:** Add \$22/1,000 and "PW" to model #.

**PRE-WIRED up to 4,000:** In stock. **PRE-WIRED 4,000+:** 4 day lead time.

1-Part Stub Style

2-Part Stub Style

# TYVEK® WRISTBANDS

Neon-colored wristbands easily identify paid customers or attendees.

- Convenient – Fits most wrist sizes.
- Water and tear-resistant.
- Quick – Remove adhesive tab and wrap around wrist.
- Assorted Pack includes 100 each of Yellow, Green, Orange, Pink and Blue.

SPECIFY COLOR: Green, Yellow, Red, Pink, Orange, White, Blue or Purple

MODEL NO.	DESCRIPTION	SIZE W x L	PRICE PER 500		
			1	2	5+
S-10751	Solid Colors	3/4 x 10"	\$49	\$44	\$39
S-15231	Assorted Pack		59	54	49
S-15235	"Drinking Age Verified"	3/4 x 10"	54	49	44
S-15234	Checkerboard				
S-15233	Stars				
S-15232	Stripes				

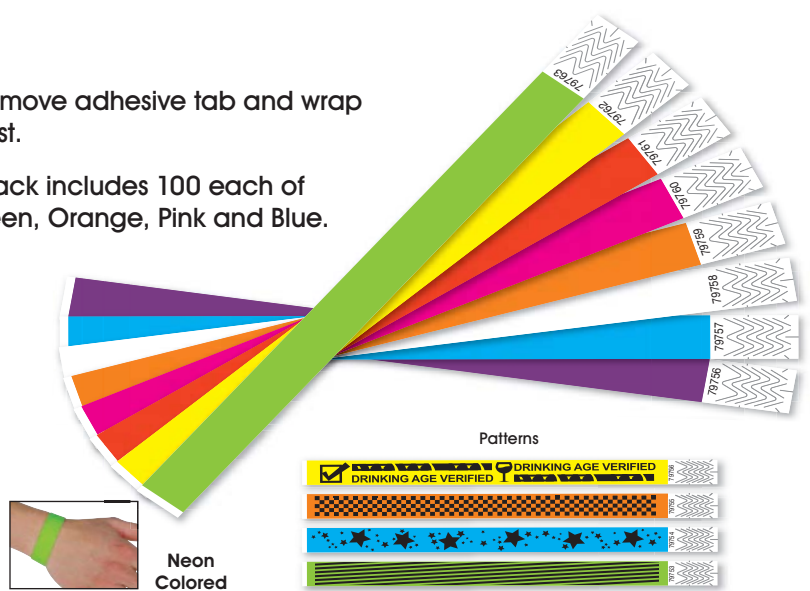

## EMBOSSABLE TAGS

Handles immediate marking needs.



- Pen, pencil or pointed objects permanently "engrave" surface.
- Aluminum foil laminated to heavy cardstock core.

PRE-WIRED: Add \$3/100 tags and add "PW" to model #.

MODEL NO.	SIZE	STOCK	PRICE PER 100		
			1	2	5+
S-15236	2" Circle	13 Point	\$44	\$43	\$41
S-15237	3 x 1"		32	31	30
S-15238	4 1/4 x 2 3/8" #5		49	47	45
S-15239	6 1/4 x 3 3/8" #8		55	53	51

## METAL TAGS

Quick, durable identification for machinery, products and parts.



- Mark valves, pipes and key sets.
- 18 gauge brass or 20 gauge stainless steel.
- Blank Tags – Stamp or engrave numbers or descriptions into the tags.
- Numbered Brass Tags 1-200.

Use with S-920 Wire Tag Ties sold on page 280

MODEL NO.	DESCRIPTION	DIAM.	PRICE PER 100	
			1	5+
S-11897	Brass	1"	\$22	\$20
S-11898		1 1/4"	38	37
S-11899		1 1/2"	49	47
S-15240		2"	76	73
S-11900	Stainless Steel	1 1/2"	74	71
S-11901	Numbered 1-100	1 1/2"	173	168
S-15241	Numbered 101-200	1 1/2"	173	168

## REPAIR TAGS

Easily track repairs. Give one part to customer, keep one with product.

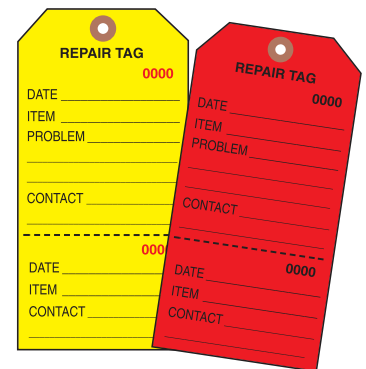

- Consecutively numbered.
- Weatherproof vinyl available, see [uline.com](http://uline.com)

PRE-WIRED: Add \$22/1,000 tags and add "PW" to model #.

SPECIFY COLOR: Yellow or Red

MODEL NO.	SIZE	PRICE PER 1,000		
		1	2	5+
S-7220	4 3/4 x 2 3/8" #5	\$76	\$71	\$62
S-10752	6 1/4 x 3 3/8" #8	85	78	72

## 5S RED TAGS

2-SIDED

Sort work materials according to 5S lean principles.

- Heavy-duty 13 pt. stock.
- Reinforced metal eyelet.

PRE-WIRED: Add \$11/500 tags and add "PW" to model #.

MODEL NO.	SIZE	PRICE PER 500		
		1	2	5+
S-24170	6 1/4 x 3 3/8" #8	\$77	\$72	\$66



Back Front

## CLAIM TAGS

2-PART

Quick, no-hassle coat and baggage claim check.

- Perforated for easy tear-off. Heavy-duty 13 pt. stock.
- Pre-strung. Loop or tie to attach tag.

SPECIFY COLOR: Manila or Green

MODEL NO.	SIZE	PRICE PER 1,000		
		1	2	5+
S-18310	4 3/4 x 2 3/8" #5	\$103	\$95	\$89

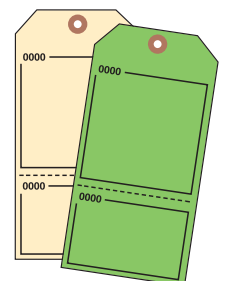

Consecutively numbered



# HANDWRAPPERS



## ULINE INDUSTRIAL

### AMERICAN MADE

Wrap pallets for less. Lightweight for all-day use.

- Tension control for desired stretch.
- Flexible rubber grip maximizes comfort, minimizes fatigue.



MODEL NO.	CAPACITY	PRICE EACH		
		1	2	4+
H-88	12", 15", 18" Rolls	\$89	\$85	\$75



## HEAVY-DUTY

### AMERICAN MADE

**Solid and durable.** Our best built handwrapper.

- **Easy To Tension** – Control knob adjusts to size of roll and bottom core holder keeps it firmly in place. **Won't slip or lose tensioning.**
- Broad zinc base **doesn't tip over.**



MODEL NO.	CAPACITY	PRICE EACH		
		1	2	4+
H-295	Rolls up to 18"	\$94	\$90	\$80
H-518	18", 20" Rolls	99	95	85



## MINI-BASE

Mini-base allows **greater flexibility** when stretch wrapping pallets.

- Tension controlled by rotating base plate in addition to control knob.



MODEL NO.	CAPACITY	PRICE EACH		
		1	2	4+
H-437	12", 15", 18", 20" Rolls	\$99	\$95	\$85

## HANDWRAPPER SPECIAL

**SAVE UP TO \$35**



Order 8+ rolls of Uline Stretch Wrap and pay as little as \$56 for our quality **Handwrappers**.

MODEL NO.	DESCRIPTION	SHPG. WT.	LIMIT ONE	
			REG.	SPECIAL
H-588	Uline	4 lbs.	<del>\$89</del>	<del>\$56</del>
H-589	Heavy Duty	5 lbs.	<del>94</del>	<del>59</del>

UPON REQUEST

## ULINE

### STRETCH WRAP CUTTER



- Angled cutter glides through stretch wrap.
- Will not bunch or stick while cutting.

MODEL NO.	PRICE EACH (MIN. 2)			
	2	6	12	24+
H-175	\$8	\$7	\$6	\$5
H-175B	Box of 100 Blades – \$30/box			

## HAND-SAVER DISPENSERS



Saves your hands when a dispenser is not available.

- Use with any 3" core stretch wrap.
- H-1588 with adjustable tension knob.

\* MINIMUM ORDER 2 PAIR

MODEL NO.	SHPG. WT.	PRICE PER PAIR		
		1-2	5	10+
H-760*	.5 lb.	\$9	\$8	\$7
H-1588	1 lb.	16	15	14

# ULINE CAST STRETCH WRAP

"Uline's 'Stealth Film' has reduced our warehouse noise by 75%. It's the only stretch film we will use."

Ted Casey, Warehouse Manager, Learning Resources

FULL LINE OF STRETCH WRAP  
PAGES 286-297



## 60 GAUGE – For loads up to 1,600 lbs.

ORDER IN CASE QUANTITIES

MODEL NO.	SIZE	GA.	CASES/ SKID	LBS./ CASE	PRICE PER ROLL (4 ROLLS/CASE)				SKID LOTS
					4	8	16	24+	
S-3210	12" x 2,000'	60	36	28	\$21	\$20	\$19	\$18	CALL FOR QUOTE
S-3211	15" x 2,000'	60	24	35	23	22	21	20	
<b>S-3212</b>	<b>18" x 2,000'</b>	<b>60</b>	<b>24</b>	<b>41</b>	<b>\$21 per roll any case quantity</b>				

ORDERS BY 6 PM SHIP SAME DAY

Our best-selling stretch film. We tested many cast films before choosing our Uline house film.

**QUIET:** Uline's "stealth film" comes off the roll smoothly and quietly.

**CLEAR:** High clarity for barcode reading or load identification.

**QUALITY:** Smooth, easy release – Wraps loads fast with little effort.

**SAVINGS:** 10% to 20% less expensive than brand-name films.

## 70 GAUGE – For loads up to 2,000 lbs.

MODEL NO.	SIZE	GA.	CASES/ SKID	LBS./ CASE	PRICE PER ROLL (4 ROLLS/CASE)				SKID LOTS
					4	8	16	24+	
S-2185	12" x 1,500'	70	36	25	\$20	\$19	\$18	\$17	CALL FOR QUOTE
S-2186	15" x 1,500'	70	24	31	22	21	20	19	
<b>S-2187</b>	<b>18" x 1,500'</b>	<b>70</b>	<b>24</b>	<b>37</b>	<b>\$20 per roll any case quantity</b>				

## 80 GAUGE – For loads up to 2,500 lbs.

MODEL NO.	SIZE	GA.	CASES/ SKID	LBS./ CASE	PRICE PER ROLL (4 ROLLS/CASE)				SKID LOTS
					4	8	16	24+	
S-2188	12" x 1,500'	80	36	28	\$21	\$20	\$19	\$18	CALL FOR QUOTE
S-2189	15" x 1,500'	80	24	35	23	22	21	20	
<b>S-2190</b>	<b>18" x 1,500'</b>	<b>80</b>	<b>24</b>	<b>41</b>	<b>\$21 per roll any case quantity</b>				

## 90 GAUGE – For loads up to 3,000 lbs.

MODEL NO.	SIZE	GA.	CASES/ SKID	LBS./ CASE	PRICE PER ROLL (4 ROLLS/CASE)				SKID LOTS
					4	8	16	24+	
S-2431	12" x 1,500'	90	36	31	\$22	\$21	\$20	\$19	CALL FOR QUOTE
S-2432	15" x 1,500'	90	24	37	24	23	22	21	
S-2433	18" x 1,500'	90	24	44	27	26	25	24	

## 120 GAUGE – For loads up to 4,000 lbs. Toughest hand film available.

MODEL NO.	SIZE	GA.	CASES/ SKID	LBS./ CASE	PRICE PER ROLL (4 ROLLS/CASE)				SKID LOTS
					4	8	16	24+	
S-5295	15" x 1,000'	120	24	35	\$23	\$22	\$21	\$20	CALL
S-3968	18" x 1,000'	120	24	41	25	24	23	22	

## SKID LOT SPECIAL

SAVE UP TO 25%



Order 24 cases of Uline's best-selling cast stretch wrap and save up to 25%.

MODEL NO.	SIZE	GAUGE	SKID PRICE PER ROLL	SKID PRICE
S-6671	18" x 1,500'	70	\$17.45	\$1,676
S-5521	18" x 1,500'	80	18.95	1,820
S-6672	18" x 1,500'	90	19.95	1,916

# ULINE COLOR TINTED STRETCH WRAP

Ideal for international shipments, warehouse color coding or dating inventory.

- Puncture-resistant 80 gauge or 120 gauge cast film.
- Extra-quiet film – Comes off the roll smoothly and quietly.
- Choose from seven different colors.

SOLD IN CASE QUANTITIES

SIZE	MODEL NO./COLOR	GAUGE	LBS./CASE	PRICE PER ROLL (4 ROLLS/CASE)				
				4	8	16	24+	
18" x 1,500'	S-2900 Red S-2900 Blue	80	39	\$26	\$23 per roll			
	S-2900 Green S-2900 Black							
	S-2900 Purple S-2900 Orange							
	S-2900 Yellow							
18" x 1,000'	S-14923 Red S-14923 Blue	120	39	27	\$26	\$25	\$23	

## OPAQUE STRETCH WRAP

Uline Cast Handwrap – Strong cast film comes off roll smoothly and quietly.

Goodwrappers® with UVI – Contain additives to repel sun's ultraviolet rays.



Opaque film conceals skids in one pass.

Recommended for **product concealment**, outdoor storage and international shipments.



SOLD IN CASE QUANTITIES

MODEL NO.	DESCRIPTION	SIZE	COLOR	GA.	LBS./CASE	PRICE/ROLL (4 ROLLS/CASE)			
						4	8	16	24+
S-5316	Uline Cast Handwrap	15" x 1,500'	Black	80	35	\$24	\$23	\$22	\$21
S-353		18" x 1,500'		80	44	26	\$23 per roll		
S-5317		18" x 1,500'		100	53	30	29	28	27
S-14000		18" x 1,000'		120	43	28	27	26	24
S-6019		18" x 1,500'	White	80	39	28	26	25	24
S-1178	Goodwrappers® with UVI	20" x 1,000'	Black	80	29	37	33	31	29
S-5296		30" x 1,000'		80	48	44	42	40	38
S-1476		20" x 800'		120	34	42	39	37	35

## ANTI-STATIC STRETCH WRAP

- Keeps your shipments free of dust while minimizing static discharge.
- Recommended for static-sensitive electronics and components.

Mini-Wrap – Narrow width for smaller electronics.



Unitize pallets while safeguarding against damage.

SOLD IN CASE QUANTITIES

MODEL NO.	DESCRIPTION	SIZE	GAUGE	ROLLS/CASE	LBS./CASE	PRICE PER ROLL		
						12-18	36	72+
S-21182	Mini-Wrap	3" x 1,000'	80	18	20	\$11	\$10	\$9
S-21183		5" x 1,000'		12	22	15	14	13
						4	8	16+
S-7626	Handwrap	12" x 1,500'	80	4	25	\$32	\$28	\$24
S-6022		18" x 1,500'				40	43	39
						1	4	8+
S-12845	Machine Length	20" x 5,000'	80	1	34	\$150	\$140	\$130





## ULINE BLOWN STRETCH WRAP

"Uline's blown stretch guarantees our shipments arrive intact and undamaged."

Wade Goff, Warehouse Manager, Uline

Premium blown film provides excellent **puncture resistance** for securing uniform or irregular loads.

- Resists puncturing or tearing, even around sharp corners.
- Superior cling keeps loads secure.
- Uline blown works even in -5°F.

**60 GAUGE** – For uniform shipments up to **1,600 lbs.** SOLD IN CASE QUANTITIES

MODEL NO.	SIZE	GA.	CASES/ SKID	LBS./ CASE	PRICE PER ROLL (4 ROLLS/CASE)				SKID LOTS
					4	8	16	24+	
S-5292	12" x 2,000'	60	36	28	\$20	\$19	\$18	\$17	CALL FOR QUOTE
S-5293	15" x 2,000'	60	24	35	22	21	20	19	
S-5294	18" x 2,000'	60	24	41	\$20 per roll any case quantity				

**70 GAUGE** – For uniform shipments up to **2,000 lbs.**

MODEL NO.	SIZE	GA.	CASES/ SKID	LBS./ CASE	PRICE PER ROLL (4 ROLLS/CASE)				SKID LOTS
					4	8	16	24+	
S-2103	12" x 1,500'	70	36	25	\$19	\$18	\$17	\$16	CALL FOR QUOTE
S-2104	15" x 1,500'	70	24	31	21	20	19	18	
S-2105	18" x 1,500'	70	24	37	\$19 per roll any case quantity				

### SKID LOT SPECIAL



**SAVE UP TO 25%**

Order 24 cases of Uline's best selling blown stretch wrap and save up to 25%.

MODEL NO.	SIZE	GAUGE	SKID PRICE PER ROLL	SKID PRICE
S-6669	18" x 1,500'	70	\$16.45	\$1,580
S-6023	18" x 1,500'	80	17.95	1,724
S-6670	18" x 1,500'	90	18.95	1,820

**REGULAR 80 GAUGE** – For loads up to **2,500 lbs.**

MODEL NO.	SIZE	GA.	CASES/ SKID	LBS./ CASE	PRICE PER ROLL (4 ROLLS/CASE)				SKID LOTS
					4	8	16	24+	
S-640	12" x 1,500'	80	36	28	\$20	\$19	\$18	\$17	CALL FOR QUOTE
S-641	15" x 1,500'	80	24	35	22	21	20	19	
S-642	18" x 1,500'	80	24	41	\$20 per roll any case quantity				

**HEAVY DUTY 90 GAUGE** – For loads up to **3,000 lbs.**

MODEL NO.	SIZE	GA.	CASES/ SKID	LBS./ CASE	PRICE PER ROLL (4 ROLLS/CASE)				SKID LOTS
					4	8	16	24+	
S-2106	12" x 1,500'	90	36	30	\$21	\$20	\$19	\$18	CALL FOR QUOTE
S-2107	15" x 1,500'	90	24	38	23	22	21	20	
S-2108	18" x 1,500'	90	24	45	26	25	24	23	

**SUPER DUTY 120 GAUGE** – Protects irregular loads up to **4,000 lbs.**

MODEL NO.	SIZE	GA.	CASES/ SKID	LBS./ CASE	PRICE PER ROLL (4 ROLLS/CASE)				SKID LOTS
					4	8	16	24+	
S-12844	15" x 1,000'	120	24	31	\$22	\$21	\$20	\$19	CALL
S-5606	18" x 1,000'	120	24	37	24	23	22	21	

# GOODWRAPPERS® PREMIUM STRETCH WRAP SYSTEM



**FREE**  
H-175 CUTTER WITH  
4 ROLLS OR MORE!



## BUILT-IN DISPENSER

The fastest, easiest way to wrap pallets.

- **Lightweight** – Eliminates the need for heavy dispensers.
- **Portable** – Travels anywhere in warehouse or truck.
- **High Performance Blown** – Excellent puncture resistance.
- **Industrial Cast** – Quiet and clear. Recommended for regular loads.
- **Black Opaque with UVI Additive** – Repels the sun's ultraviolet rays.

## IT'S SO EASY!

"It's so easy. Just pull out of the box and it's ready to use. You don't even need a dispenser."

Ray Miller, Uline Quality Assurance Mgr.

### ULINE BLOWN GOODWRAPPERS®

MODEL NO.	SIZE	FILM	GAUGE	LBS./CASE	PRICE PER ROLL (4 ROLLS/CASE)					
					1	4	8	16	48	100+
S-330	5" x 1,000'	Purple Tinted Blown	80	10	N/A	\$15	\$14	\$13	\$12	CALL FOR QUOTE
S-110	10" x 1,000'		80	17	\$25	23	22	21	20	
S-155	15" x 1,000'		80	23	27	25	23	22	21	
S-244	20" x 1,000'		80	31	30	29	28	27	26	
S-335	30" x 1,000'		80	45	40	39	37	36	35	
S-139	20" x 800'		120	34	38	37	35	34	33	

### ULINE CAST GOODWRAPPERS®

SOLD IN CASE QUANTITIES

MODEL NO.	SIZE	FILM	GAUGE	LBS./CASE	PRICE PER ROLL (4 ROLLS/CASE)				
					4	8	16	48	100+
S-8137	20" x 1,000'	Clear Cast	70	25	\$24	\$23	\$22	\$21	CALL FOR QUOTE
<b>S-2167</b>	<b>20" x 1,000'</b>		<b>80</b>	<b>31</b>	<b>\$22 per roll any case quantity</b>				
S-2371	30" x 1,000'		80	45	36	34	33	32	
S-8140	20" x 800'		120	36	34	32	31	30	

### COLOR TINTED CAST GOODWRAPPERS®

MODEL NO.	SIZE	COLOR	GAUGE	LBS./CASE	PRICE PER ROLL (4 ROLLS/CASE)				
					4	8	16	48	100+
S-2670R	20" x 1,000'	Red	80	31	\$29	\$28	\$27	\$25	CALL FOR QUOTE
S-2670BLU		Blue							
S-2670G		Green							
S-2670O		Orange							
S-2670BL		Black							

### BLACK OPAQUE CAST GOODWRAPPERS® – Contains UVI additives that repel sun's ultraviolet rays.

MODEL NO.	SIZE	COLOR	GAUGE	LBS./CASE	PRICE PER ROLL (4 ROLLS/CASE)				
					4	8	16	24	100+
S-1178	20" x 1,000'	Black	80	29	\$37	\$33	\$31	\$29	CALL FOR QUOTE
S-5296	30" x 1,000'		80	48	44	42	40	38	
S-1476	20" x 800'		120	34	42	39	37	35	

### Disposable handles give workers a "brake."

- Control tension for maximum film stretch.
- Uses 25-33% less film.
- Wraps your load extra tight for security.
- Prevents friction buildup on hands.







**SAVE UP TO 30%**

**ECONOMICAL** – 5" extended core serves as a handle and eliminates the need for a dispenser.

**HIGH PERFORMANCE** – Premium-grade cast film has excellent clarity and quiet operation. Outperforms tape and strapping at a lower cost.

**HEAVY DUTY** – Super tough 120 gauge now available in cast film.

**BLACK OPAQUE** – Quiet cast film recommended for product concealment and outdoor storage. Ideal for light-sensitive products.

**BLOWN** – Protection for your heavy, irregular or hard-to-wrap shipments.

SOLD IN CASE QUANTITIES

MODEL NO.	DESCRIPTION	SIZE	GAUGE	LBS./CASE	PRICE PER ROLL (4 ROLLS/CASE)				
					4	8	16	24	48+
S-3398	Cast	20" x 1,000'	70	24	\$22	\$21	\$20	\$19	\$18
S-3399		30" x 1,000'	70	36	30	28	27	26	25
S-3213		15" x 1,000'	80	19	21	20	19	18	17
<b>S-1831</b>		<b>20" x 1,000'</b>	<b>80</b>	<b>26</b>	<b>\$18 per roll any case quantity</b>				
S-1832		30" x 1,000'	80	39	34	31	30	29	28
S-6018		15" x 1,000'	90	22	23	22	21	20	19
S-2445		20" x 1,000'	90	32	26	24	23	22	21
S-2446		30" x 1,000'	90	45	36	33	32	31	30
S-11445	Heavy Duty Cast	20" x 800'	120	34	29	27	26	25	24
S-11446	Black Opaque	20" x 1,000'	80	29	26	24	23	22	21
S-13999		20" x 800'	120	34	32	30	29	28	27
S-11447	Blown	20" x 1,000'	80	29	27	25	24	23	22





# ULINE BUNDLE WRAP



1" CORE

1" diameter extended core is less bulky and easier to handle.

- Built-in disposable handle is ready to use right out of the box.
- High quality Uline cast film.

Super Duty – Strong 150 gauge recommended for lumber.

Colors – Six stock colors for fast product identification.



SOLD IN CASE QUANTITIES \*SPECIFY COLOR: Red White Blue Yellow Black Green

MODEL NO.	DESCRIPTION	SIZE	GAUGE	ROLLS/CASE	LBS./CASE	PRICE PER ROLL			
						12-18	36	72	144+
S-5056	Regular	3" x 1,000'	80	18	18	\$5.50	\$5.15	\$4.80	\$4.45
S-5057		5" x 1,000'		12	20	9.05	8.45	7.85	7.25
S-5058	Heavy Duty	3" x 650'	100	18	14	5.50	5.15	4.80	4.45
S-5059		5" x 650'		12	16	9.00	8.40	7.80	7.20
S-12990	Super Duty	3" x 600'	150	18	22	5.70	5.30	4.95	4.55
S-6673		5" x 600'		12	24	9.55	9.10	8.65	8.15
S-17967*	Colors	3" x 1,000'	80	18	18	6.70	6.30	5.95	5.55
S-17968*		5" x 1,000'		12	20	11.35	10.80	10.25	9.70



1 3/4" CORE

## GOODWRAPPERS®

Patented dispenser provides a hand "brake" for instant tension control.

- High quality cast film.
- **FREE** H-761 Dispenser with an order of one case or more.

SOLD IN CASE QUANTITIES

MODEL NO.	DESCRIPTION	SIZE	GAUGE	ROLLS/CASE	LBS./CASE	PRICE PER ROLL			
						12-18	36	72	144+
S-6139	Regular	3" x 1,000'	80	18	18	\$5.95	\$5.60	\$5.20	\$4.85
S-6140		5" x 1,000'		12	20	9.65	9.05	8.45	7.80
S-6141	Heavy Duty	3" x 600'	120	18	15	5.90	5.45	5.15	4.75
S-6142		5" x 600'		12	18	9.70	9.25	8.75	8.20
H-761	Adjustable Tension Dispenser – \$10.45 each								



1 3/4" CORE

## GOODWRAPPERS® IDENTI-WRAP™

**80 GAUGE**

Instruct or code while you unitize.

- 2 **FREE** H-761 Dispensers with each case.
- High quality cast film.

**DO NOT BREAK LOAD**

S-104

**DO NOT DOUBLE STACK**

S-144

**DO NOT ACCEPT IF SEAL IS BROKEN**

S-3337

STOCK ROLLS

SOLD IN CASE QUANTITIES

MODEL NO.	DESCRIPTION	SIZE	COLOR	ROLLS/CASE	LBS./CASE	PRICE PER ROLL		
						6	12	24+
S-104, S-144, S-3337	Messages	5" x 500'	Red	6	11	\$14	\$13	\$12

# ULINE MINI-WRAP

**ULINE'S HOUSE BRAND – SAVE UP TO 30%**

Bundle, band, wrap or tie with Uline's narrow width stretch film.

- High quality regular or heavy-duty cast film clings to itself without adhesives. Residue free.
- Economical alternative to strapping, tape, twine or wire.
- Dispenser holds 2", 3" and 5" rolls.
- Color code your shipments. 6 stock colors available.
- **FREE** Plastic Dispenser included with each case.



SOLD IN CASE QUANTITIES

\* SPECIFY COLOR: Blue, Red, Black, Green, Yellow or White

MODEL NO.	DESCRIPTION	SIZE	GAUGE	ROLLS/CASE	LBS./CASE	PRICE PER ROLL			
						12-24	36-48	72	144+
S-12790	Regular	2" x 1,000'	80	24	20	\$4.10	\$3.75	\$3.45	\$3.15
S-4208		3" x 1,000'		18	20	<b>\$4.05 per roll any case qty.</b>			
S-4209		5" x 1,000'		12	22	8.40	8.00	7.50	7.00
S-12791	Heavy Duty	2" x 650'	100	24	17	4.10	3.75	3.45	3.15
S-4211		3" x 650'		18	17	5.00	4.75	4.45	4.15
S-4214		5" x 650'		12	18	8.40	8.00	7.50	7.00
S-6103*	Colors	3" x 1,000'	80	18	20	6.20	5.90	5.60	5.30
S-11449*		5" x 1,000'		12	22	10.75	10.20	9.65	9.10



## MASTERWRAP

No mess – Wraps and unwraps easily without damaging or leaving residue.

- Economical – Costs less than tape, twine or strapping.
- Heavy duty for top banding. Regular for wrapping or tying.
- **FREE** Plastic Dispenser included with each case.

SOLD IN CASE QUANTITIES

MODEL NO.	DESCRIPTION	SIZE	GAUGE	ROLLS/CASE	LBS./CASE	PRICE PER ROLL			
						12-18	36	72	144+
S-733	Regular	3" x 1,000'	90	18	23	\$7.25	\$7.00	\$6.75	\$6.35
S-741		5" x 1,000'		12	24	11.55	10.90	10.35	9.75
S-734	Heavy Duty	3" x 600'	120	18	22	7.00	6.65	6.25	5.80
S-742		5" x 600'		12	22	11.10	10.50	9.90	9.30



## MINI-WRAP DISPENSERS

- Plastic and Metal Dispensers hold 2", 3" and 5" rolls of Mini-Wrap.
- H-93 Metal Dispenser adjusts to desired stretch.

MODEL NO.	DISPENSER DESCRIPTION	PRICE EACH
H-68	Plastic	\$9.95
H-93	Metal with Adjustable Setting	29.95



# TOP SHEETING



Perforated Sheets.  
3" Core.

Prevent costly damage to tops of pallets from dust, dirt and moisture during shipment or storage.

- Each sheet folded to 1/2 the finished width.

## KIT

MODEL NO.	DESCRIPTION	PRICE EACH		
		1	3	6+
H-50	Includes 1 roll of S-331 and 2 mounting brackets	\$105	\$99	\$95

## KIT REFILL ROLLS

MODEL NO.	SHEET SIZE	MIL	CORE	SHEETS/ROLL	PRICE PER ROLL		
					1	4	8+
S-331	60 x 60"	1.25	1"	75	\$57	\$55	\$51

## TOP SHEETING ROLLS

\*Black Opaque

MODEL NO.	SHEET SIZE	MIL	CORE	SHEETS/ROLL	PRICE PER ROLL		
					1	4	8+
S-11470	48 x 48"	1.5	3"	500	\$152	\$146	\$141
S-6020	60 x 60"			250	\$104 per roll any quantity		
S-11475*	60 x 60"			250	119	115	111
S-11471	60 x 72"			250	143	137	132
S-11472	72 x 72"			200	137	131	126
S-11473	36 x 36"	3		250	88	84	81
S-11474	60 x 60"			150	143	137	132

# STRETCH WRAP MACHINES



H-1020  
with H-1071  
Ramp sold separately.

## SEMI-AUTOMATIC

Increase productivity and eliminate worker strain. Ideal for medium volume operations.

- Wraps approximately 20 loads per hour – 12 RPM variable speed turntable.
- Two wrap modes – Select spiral up and down or spiral up only.
- Convenient photo eye – Allows operator to walk away.
- Adjusts from 20% to 150% stretch.
- Troubleshooting screen. • 115 volt, 15 amp.
- H-1619 machine has built-in scale with +/- 1 lb. accuracy.



H-1619 SCALE

MORE STRETCH WRAP MACHINES, VISIT [ULINE.COM](http://ULINE.COM)

## MACHINES

MODEL NO.	MAX. SKID SIZE L x W x H	LOAD CAPACITY	ROLL WIDTH	SHPG. WT.	PRICE EACH	MODEL NO.	PRICE EACH
H-1020	52 x 52 x 80"	4,000 lbs.	20"	1,175 lbs.	\$7,565	H-1071	\$835
H-1675*	52 x 52 x 110"			1,250 lbs.	8,430		

## OPTIONAL RAMP

## MACHINE WITH SCALE

MODEL NO.	MAX. SKID SIZE L x W x H	CAPACITY/ ACCURACY	ROLL WIDTH	SHPG. WT.	PRICE EACH	MODEL NO.	PRICE EACH
H-1619	52 x 52 x 80"	4,000 lbs. x 1 lb.	20"	1,500 lbs.	\$12,000	H-1676	\$2,375

\*Some assembly required

DROP SHIPS FROM MI

# STRETCH WRAP TURNTABLES

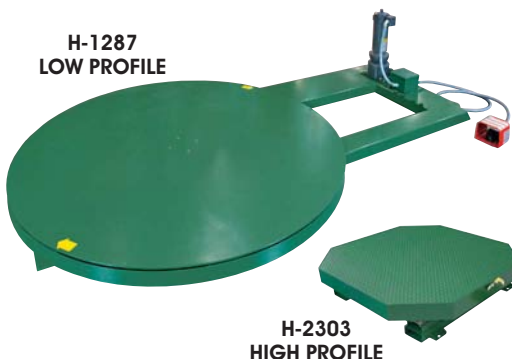

H-1287  
LOW PROFILE

H-2303  
HIGH PROFILE

Foot pedal controls greatly facilitate hand wrapping.

- Wrap up to 10-12 loads per hour. Speed adjusts to 12 RPM.

**LOW PROFILE** – Easy to load and unload pallets.

- 3¼" high. • 115 volt, 15 amp. • 1/2 HP motor. Forklift slots for transport.

**HIGH PROFILE** – Raised platform provides easy access to secure loads.

- 13½" high. • 115 volt, 15 amp. • 3/4 HP motor. Front and rear forklift slots.

## LOW PROFILE

MODEL NO.	MAX. SKID SIZE	LOAD CAPACITY	MAX. ROLL WIDTH	SHPG. WT.	PRICE EACH	MODEL NO.	PRICE EACH
H-1287	52 x 52"	4,000 lbs.	18"	719 lbs.	\$3,235	H-2958	\$1,015

## OPTIONAL RAMP

## HIGH PROFILE

H-2303	60 x 60"	4,000 lbs.	18"	700 lbs.	\$3,455	N/A	N/A
--------	----------	------------	-----	----------	---------	-----	-----

DROP SHIPS FROM MI



# ULINE MACHINE LENGTH STRETCH FILM

**CAST FILM** – Clear and quiet. For uniform loads.  
Stretches up to 250%.

**BLOWN FILM** – Puncture resistant. For irregular loads.  
Stretches up to 250%.

**BLACK OPAQUE** – For complete product concealment.

**COLOR TINTED** – Ideal for easy product identification and dating inventory.

**ONE-SIDED CLING** – Holds load tight without sticking to nearby pallets. High clarity and quiet unwind. Cast film.  
Stretches up to 250%.

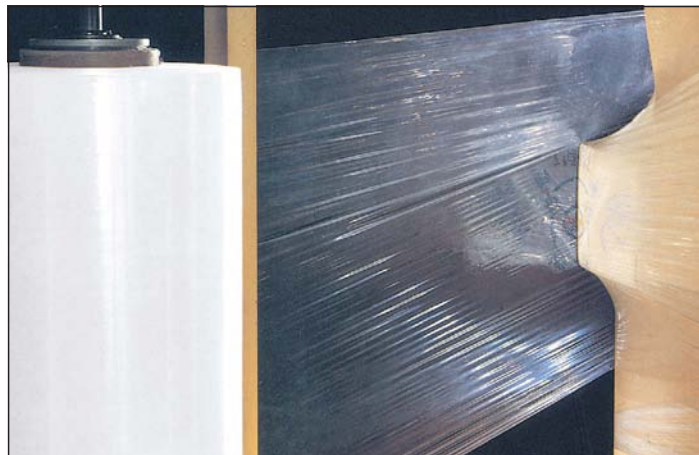

MODEL NO.	DESCRIPTION	SIZE	GAUGE	ROLLS/SKID	LBS./ROLL	PRICE PER ROLL (MIN. 6)		
						6	12+	SKID LOTS
S-2204	Uline Cast	20" x 6,000'	60	32	32	\$74	\$70	\$61
S-3907		20" x 8,000'	60	32	38	98	92	82
S-6668		20" x 6,500'	70	32	36	95	89	78
S-14927		20" x 5,000'	75	32	33	78	73	64
S-11498		20" x 6,000'	75	32	36	92	88	77
S-2193		20" x 5,000'	80	32	32	82	78	68
S-1524		20" x 6,000'	80	32	40	98	92	82
S-6667		20" x 5,000'	90	32	36	92	88	77
S-8144		20" x 4,000'	120	32	38	98	92	82
S-8143		30" x 5,000'	80	16	48	122	115	102
S-12899	Uline Blown	20" x 6,000'	60	32	32	81	77	70
S-8145		20" x 6,000'	70	32	33	98	91	82
S-834		20" x 5,000'	80	32	36	91	86	78
S-6143		20" x 6,000'	80	32	38	108	103	93
S-12900		20" x 5,000'	90	32	38	103	97	88
S-12901		20" x 4,000'	120	32	40	108	103	93
S-6145	Red Cast	20" x 6,000'	80	32	40	108	103	99
S-6146	Blue Cast	20" x 6,000'	80	32	40	108	103	99
S-14929	Green Cast	20" x 6,000'	80	32	40	108	103	99
S-6144	Black Opaque Cast	20" x 6,000'	80	32	40	108	103	99
S-17856	Orange Cast	20" x 6,000'	80	32	40	108	103	99
S-12988	One-Sided Cling	20" x 6,500'	70	32	36	90	86	78
S-11499		20" x 6,000'	80	32	40	95	90	82

**SKID LOT SPECIAL**

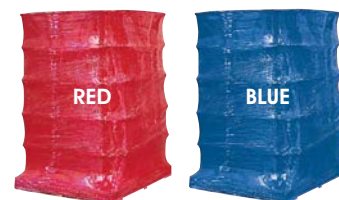

## PORTABLE STRETCH WRAP DISPENSER/FILM

Wrap large, bulky pallets up to 70" tall with this rolling dispenser.

- Heavy duty, quality swivel casters glide throughout your warehouse.
- Handles film rolls from 10 to 70". • Adjustable tension control.

MODEL NO.	DESCRIPTION	SIZE	GAUGE	LBS./ROLL	SHIPS VIA MOTOR FREIGHT PRICE PER ROLL		
					1	3	6+
S-17973	Uline Cast	40" x 5,000'	80	70	\$147	\$139	\$130
S-12987		50" x 5,000'		88	182	173	163
S-12828		60" x 5,000'		105	214	204	194
S-14930		70" x 5,000'		120	248	238	227
H-2319	Portable Dispenser			80	1/\$795 2+/\$775		



**Cast Stretch Wrap** – Clear and quiet. Smooth, easy release. For uniform loads up to 2,500 lbs. Stretches up to 250%.

# PROTECTIVE NETTING



Flexible polyethylene netting slides easily over odd size objects.

- Recommended for machine parts.
- Protects against surface nicks and abrasions.
- Close mesh style.

Heavy Duty – 2 times thicker than standard netting.

- Recommended for auto crankshafts and heavier parts.

\* SPECIFY COLOR: Blue, Yellow, Red, White, Black or Green

MODEL NO.	DIAMETER	ROLL LENGTH	COLOR	PRICE PER ROLL			LBS./ROLL
				1	2	4+	
S-11558	1/4 - 3/8"	820'	Red	\$109	\$103	\$97	7
S-6578	3/8 - 5/8"		Orange	102	96	91	8
S-6579*	1/2 - 1"	164'	Specify Color	140	131	122	13
S-6580*	1 - 2"			44	42	40	4
S-6581*	2 - 4"			66	63	60	6
S-6698*	4 - 6"			99	93	87	9
S-9965	6 - 8"	164'	Brown	116	110	103	10
S-9966	8 - 9"		Clear	139	131	122	13
S-14032	10 - 12"		Green	167	158	150	15
S-14033	1/4 - 3/8"	1,500'	Red	153	144	136	11
S-12792	3/8 - 5/8"		Orange	165	155	144	13
S-12793*	1/2 - 1"	1,500'	Specify Color	228	217	206	28
S-11559*	1 - 2"			309	292	276	32
S-11560*	2 - 4"			464	447	430	48
S-17947*	4 - 6"			500'	339	323	306
S-17948	6 - 8"	500'	Brown	362	345	328	30

## HEAVY-DUTY PROTECTIVE NETTING

MODEL NO.	DIAMETER	ROLL LENGTH	COLOR	PRICE PER ROLL			LBS./ROLL
				1	2	4+	
S-17962	1¼ - 1½"	82'	Yellow	\$82	\$77	\$74	7
S-17963	2 - 2½"		Red	91	86	83	7
S-17964	2½ - 3"		Green	96	92	87	7
S-17965	3 - 5"		Blue	99	94	90	7
S-17966	5 - 8"		Red	101	96	92	8

# VENTED PALLET WRAP

**ALLOWS PRODUCT TO BREATHE**

Recommended for use with perishables like dairy products, fresh fruits and vegetables, beverages, frozen foods and pharmaceuticals.

- Die-cut ventilation holes allow better cooling and reduce spoilage.
- FDA compliant for indirect food contact.
- Machine wrap stretches up to 250%.



## HANDWRAP

SOLD IN CASE QUANTITIES

MODEL NO.	SIZE	ROLLS/CASE	LBS./ROLL	PRICE PER ROLL		
				4	8	16+
S-11500	20" x 1,550'	4	6	\$70	\$65	\$60

## MACHINE WRAP

MODEL NO.	SIZE	ROLLS/SKID	LBS./ROLL	PRICE PER ROLL		
				1	4	8+
S-11501	20" x 3,280'	28	35	\$260	\$250	\$240

# STRETCH NETTING

**STABILIZES LOADS**

Strong knitted netting provides excellent load stability.

- Recommended for food industry bags and applications that require airflow and stabilization.
- Machine netting stretches up to 100%.

## HAND NETTING

\* Hard polypropylene

MODEL NO.	SIZE	ROLLS/CASE	LBS./ROLL	PRICE PER ROLL		
				1	4	8+
S-6147*	12" x 2,000'	4	5	N/A	\$51	\$49
S-9964	20" x 3,000'		9	\$113	107	101

## MACHINE NETTING

MODEL NO.	SIZE	ROLLS/SKID	LBS./ROLL	PRICE PER ROLL		
				1	4	8+
S-11561	20" x 15,000'	32	38	\$330	\$320	\$310





# ULINE ECONOMY CAST STRETCH WRAP

## STANDARD

When all you need is a no frills, general purpose stretch wrap.

- Quiet, clear cast stretch wrap. • Easy release, rolls on smoothly.
- Keeps load from shifting during shipping and transport.

SOLD IN CASE QUANTITIES

MODEL NO.	SIZE	GAUGE	CASES/SKID	LBS./CASE	PRICE PER ROLL (4 ROLLS/CASE)				SKID LOTS
					4	8	16	24+	
S-12826	18" x 1,500'	70	24	37	\$18 per roll any case qty.				CALL FOR QUOTE
S-12827	18" x 1,500'	80	24	41	\$19 per roll any case qty.				



## NEW TECH

Wrap your pallets for pennies. • New age resin creates thin films with standard strength.

39 GAUGE CAST – Replaces standard 60 - 70 ga. films.

SOLD IN CASE QUANTITIES

MODEL NO.	SIZE	GAUGE	MICRON	LBS./CASE	PRICE PER ROLL (4 ROLLS/CASE)				SKID LOTS
					4	8	16	24+	
S-14925	16" x 1,500'	39	10	18	\$17	\$16	\$15	\$14	CALL FOR QUOTE
S-14156	17.5" x 1,500'			21	18	17	16	15	

47 GAUGE CAST – Replaces standard 70 - 80 ga. films.

S-14926	16" x 1,500'	47	12	20	\$18	\$17	\$16	\$15	CALL FOR QUOTE
S-13347	17.5" x 1,500'			24	\$15 per roll any case qty.				

65 GAUGE CAST – Replaces standard 80 - 90 ga. films.

S-3789	16" x 1,500'	65	16.5	29	\$20	\$19	\$18	\$17	CALL FOR QUOTE
S-11448	17.5" x 1,500'			32	21	20	19	18	

75 GAUGE CAST – Replaces standard 90 - 120 ga. films.

S-9968	17.5" x 1,500'	75	19	36	\$22	\$21	\$20	\$19	CALL
--------	----------------	----	----	----	------	------	------	------	------



# ULINE MACHINE LENGTH STRETCH WRAP

## HIGH PERFORMANCE

New polypropylene resin provides superior puncture resistance.

- Stretches up to 300%. • Quiet. Excellent clarity.
- Recommended for use with automatic stretch film machines.

MODEL NO.	DESCRIPTION	SIZE	GA.	ROLLS/SKID	LBS./ROLL	PRICE PER ROLL		SKID LOTS
						6	12+	
S-12902		20" x 9,000'	48		35	\$95	\$91	\$83
S-12903	Uline Cast	20" x 6,500'	55	32	29	80	77	69
S-12904		20" x 6,000'	61		30	83	79	71



## PALLET BANDS

Secure pallet covers, tarps and sheeting.

- Prevent toppling of cartons.
- Durable rubber bands stretch 200-300%.
- Additional Rubber Bands, see page 109.



STANDARD – NATURAL

SOLD IN CARTON QUANTITIES

MODEL NO.	WIDTH x CIRCUMFERENCE	FITS PALLET SIZE	QTY./CTN.	PRICE PER BAND		
				50	100	200+
S-3876	3/4 x 72"	36 x 36"		\$2.40	\$2.30	\$2.20
S-3877	3/4 x 84"	36 x 48"	50	2.50	2.40	2.30
S-3878	3/4 x 92"	40 x 48"		2.60	2.50	2.40

HEAVY DUTY – GREEN

SOLD IN CARTON QUANTITIES

MODEL NO.	WIDTH x CIRCUMFERENCE	FITS PALLET SIZE	QTY./CTN.	PRICE PER BAND		
				50	100	200+
S-17899	1 1/2 x 72"	36 x 36"		\$4.10	\$4.00	\$3.90
S-17900	1 1/2 x 84"	36 x 48"	50	4.20	4.10	4.00
S-17901	1 1/2 x 92"	40 x 48"		4.40	4.20	4.00



# ULINE STRAPPING CARTS

## INDUSTRIAL

Uline's **best-selling** cart. Sturdy and dependable.

- **For polypropylene, polyester or steel strapping.** Fits core sizes 16 x 3" and 16 x 6".
- **Big 10" rubber and steel wheels** for easy maneuvering. Automatic brake. Large tray for storing seals and tools.



MODEL NO.	DESCRIPTION	SHPG. WT.	PRICE EACH	
			1	2+
H-39	Uline Strapping Cart	59 lbs.	\$405	\$395

## DELUXE

**Designed for steel strapping.**

- Heavy-duty brake keeps steel strapping from unwinding (see inset).
- Fits core size 16 x 3".
- Holds 3/8" to 1" wide strapping.



HEAVY-DUTY BRAKE

MODEL NO.	DESCRIPTION	SHPG. WT.	PRICE EACH	
			1	2+
H-279	Deluxe Steel Cart	54 lbs.	\$450	\$440

## ORGAPACK SEALLESS COMBO TOOL

### NEW AND IMPROVED

Completely re-engineered for enhanced handling and performance.

- New technology LED touch screen with protective bumper.
- 18V Li-ion battery for up to 800 seals per charge.



ORT260 AUTOMATIC

For more information, see page 306

MODEL NO.	FITS STRAPPING WIDTHS	FOR STRAPPING THICKNESS	TENSION CAPACITY	PRICE EACH	
				1	2+
H-7207	1/2, 5/8"	.019 - .040	560 lbs.	\$3,750	\$3,700

## PALLET TRUCK EXTRA NARROW

Easily move skids of strapping coils.

- Fits into narrow pallets.
- 3-position hand control – Raise, lower, neutral.
- 3" lowered and 7.5" raised height.



MODEL NO.	DESCRIPTION	FORK SIZE L x W	LOAD CAPACITY	WT. (LBS.)	PRICE EACH	
					1	3+
H-4122	Short/Extra Narrow	36 x 16"	4,400 lbs.	127	\$645	\$615

SHIPS ASSEMBLED VIA MOTOR FREIGHT

## SPECIAL STEEL TOOL OFFER

### SAVE \$100

Order our **Industrial Steel Strapping Tools and Cart** together for extra savings.

Offer includes: Sealer\*, H-242, H-41 and H-279.



H-279 CART



H-350, 1, 2, 3 SEALER\*

H-242 TENSIONER

H-41 CUTTER

\* Specify sealer size – 3/8", 1/2", 5/8" or 3/4"

MODEL NO.	INCLUDES:	SHPG. WT.	REG. PRICE	SALE PRICE
H-622	Deluxe Steel Cart with Tensioner, Sealer* and Cutter	65 lbs.	<del>\$805</del>	<b>\$705</b>

# STEEL STRAPPING

SEE [ULINE.COM](http://ULINE.COM) FOR CURRENT PRICING

## STANDARD GRADE

MEETS FED. SPEC. ASTM D3953

MODEL NO.	WIDTH	THICKNESS	BREAK STRENGTH	APPROX. LENGTH	COILS/SKID	LBS./COIL	PRICE PER COIL			SKID LOTS	USES SEAL
							1	2	6+		
S-822	3/8"	.015	680 lbs.	5,502'	12	105	\$260	\$252	\$245	\$186	S-831
S-2079		.020	900 lbs.	4,116'			258	250	243	178	
S-817	1/2"	.015	910 lbs.	4,127'	12	105	256	248	241	158	S-827
S-825		.020	1,200 lbs.	3,087'			\$216 per coil any qty.			136	
S-1081		.023	1,380 lbs.	2,688'			230	223	216	134	
S-1549	5/8"	.015	1,125 lbs.	3,297'	12	105	253	245	238	159	S-832
S-823		.020	1,500 lbs.	2,468'			240	232	225	140	
S-1082		.023	1,725 lbs.	2,153'			230	223	216	136	
S-1548	3/4"	.015	1,360 lbs.	2,751'	12	105	251	243	236	158	S-828
S-826		.020	1,800 lbs.	2,058'			240	232	225	140	
S-829		.023	2,070 lbs.	1,796'			237	229	222	136	
S-2427		.025	2,500 lbs.	1,649'			249	241	234	163	
S-6058		.028	2,400 lbs.	1,470'			243	235	228	147	
S-3280		.031	3,300 lbs.	1,334'			253	245	238	155	

SHIPS VIA MOTOR FREIGHT

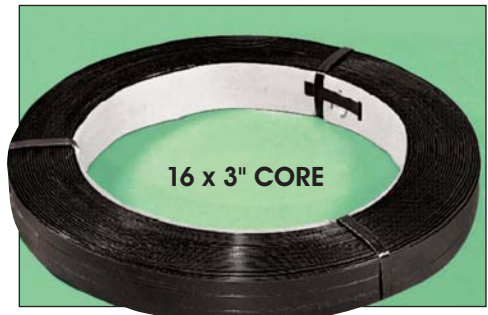

Don't take a chance with heavy shipments that need more protection than poly strapping can provide.

### STANDARD GRADE

- 105 lbs. approximate weight/coil.
- Can be used with Signode tools.
- Painted and waxed finish.

### SUPER DUTY

MEETS FED. SPEC. ASTM D3953

MODEL NO.	WIDTH	THICKNESS	BREAK STRENGTH	APPROX. LENGTH	COILS/SKID	LBS./COIL	PRICE PER COIL			SKID LOTS	USES SEAL
							1	2	6+		
S-3820	1/2"		1,305 lbs.	3,665'	12	105	\$257	\$249	\$242	\$164	S-827
S-5010	5/8"	.017	1,630 lbs.	2,909'			257	249	242	164	S-832
S-3822	3/4"		1,960 lbs.	2,426'			257	249	242	164	S-828

SHIPS VIA MOTOR FREIGHT

New technology has created stronger, lighter steel strapping.

- .017 Super Duty has strength of .023 Standard Grade.
- 35% longer coils cost only 17% more.
- Painted and waxed finish.

### HIGH TENSILE

MEETS FED. SPEC. ASTM D3953

MODEL NO.	WIDTH	THICKNESS	BREAK STRENGTH	APPROX. LENGTH	COILS/SKID	LBS./COIL	PRICE PER COIL			SKID LOTS	USES SEAL
							1	2	6+		
S-2080	1/2"	.020	1,450 lbs.	3,087'	12	105	\$261	\$253	\$246	\$166	S-827
S-1644		.023	1,725 lbs.	2,688'			262	254	247	165	
S-6059		.031	2,260 lbs.	1,992'			262	254	247	164	
S-2081	5/8"	.020	1,830 lbs.	2,478'	12	105	269	261	254	168	S-832
S-2255		.023	2,150 lbs.	2,152'			250	242	235	163	
S-2082	3/4"	.020	2,100 lbs.	2,058'	12	105	268	260	253	166	S-828
S-2256		.023	2,470 lbs.	1,795'			264	256	249	163	
S-1084		.025	2,690 lbs.	1,649'			252	244	237	156	
S-6060		.029	3,320 lbs.	1,418'			252	244	237	155	
S-863		.031	3,500 lbs.	1,334'			253	245	238	154	
S-2997*		1 1/4"	.025	4,650 lbs.			1,034'	20	110	256	
S-3974*	.029		5,450 lbs.	891'	242	234	227			151	
S-830*	.031		5,500 lbs.	836'	243	235	228			152	
S-15310*	2"	.044	12,300 lbs.	363'	16	110	263	255	248	181	S-15311

\*Ribbon wound. Cart available, see [uline.com](http://uline.com)

SHIPS VIA MOTOR FREIGHT

### HIGH TENSILE

- For heavier loads. Keeps shipments secure during sudden stops.
- Recommended for use on railroad shipments.
- Painted and waxed finish.

### SKID LOT SPECIAL



SAVE UP TO 40%  
ON SKID QUANTITIES

# SPECIALTY STEEL STRAPPING TOOLS

## HIGH TENSILE

**H-528**  
HIGH TENSILE  
TENSIONER



**H-243**  
SIDE ACTION  
HIGH TENSILE SEALER



**H-601**  
HIGH TENSILE CUTTER

**H-529, H-530, H-531**  
HIGH TENSILE SEALERS



**H-279**  
CART

High tensile tools are recommended for .025 to .031 tensile or thicker steel strapping.

MODEL NO.	DESCRIPTION	FITS STRAPPING WIDTH	FITS TENSILE	LBS. EACH	PRICE EACH	
					1	2+
H-528	Tensioner	3/4 to 1 1/4"	.025 - .031	5	\$340	\$330
H-529	Sealers	1/2"	.023 - .031	5	195	185
H-530		5/8"		5	195	185
H-531		3/4"		5	195	185
H-243	Sealer	1 1/4"	.025 - .035	11	305	295
H-601	2" Cutter	3/8 to 2"	.015 - .044	6	135	125

## HIGH TENSILE TOOL OFFER

**SAVE UP TO \$150**

MODEL NO.	INCLUDES:				FITS STRAPPING WIDTH	REG. PRICE	SALE PRICE
	CART	TENSIONER	SEALER	CUTTER			
H-851		H-242	H-529		1/2"	<del>\$783</del>	<b>\$823</b>
H-852	H-279	H-242	H-530	H-601	5/8"	<del>933</del>	<b>823</b>
H-853		H-528	H-531		3/4"	<del>1,120</del>	<b>990</b>
H-854	H-396*	H-528	H-243	H-601	1 1/4"	<del>1,370</del>	<b>1,220</b>

\* Cart different than style pictured

## PUSHER TOOLS/SEALS



FOR USE ON  
ROUND SURFACES



**H-623**  
PUSHER TENSIONER



**H-768, H-769, H-770**  
SINGLE NOTCH SEALERS

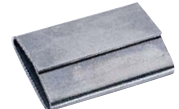

PUSHER SEALS



**H-738, H-814**  
DELUXE PUSHER TENSIONERS

Easier loading and unlimited strap take-up.

Pusher tools/seals are all recommended for use on round surfaces with steel strapping.

MODEL NO.	DESCRIPTION	FITS STRAPPING WIDTH	FITS TENSILE	LBS. EA.	PRICE EACH	
					1	2+
H-623	Tensioner	3/8 to 1 1/4"	.015 - .031	5	\$355	\$345
H-738	Deluxe Tensioners	3/8 to 3/4"	.015 - .023	4	570	560
H-814*		3/4 to 1 1/4"	.025 - .035	6	710	695
H-768	Single Notch Sealers	1/2"	.015 - .023	3	245	235
H-769		5/8"		3	245	235
H-770		3/4"		3	245	235
S-1067	Metal Pusher Seals	1/2 x 7/8"	1,000 Per Ctn.	7	28	26
S-1068		5/8 x 7/8"		8	34	31
S-1069		3/4 x 1"		9	38	35
S-13080▲		3/4 x 2"		44	69	63
S-6430▲		1 1/4 x 2 1/4"		60	124	115

▲ Heavy-Duty Pusher Seal

\* High Tensile



**1. TENSIONER**  
Tightens strapping.



**2. SEALER**  
Closes seals on strapping.



**3. CUTTER**  
Cuts excess strapping.



**H-279 CART**



# STEEL STRAPPING TOOLS



H-40 STANDARD CUTTER

MODEL NO.	DESCRIPTION	FITS STRAPPING WIDTH	FITS TENSILE	LBS. EACH	PRICE EACH	
					1	2+
H-38	Tensioner	3/8 to 3/4"	.015 - .023	5	\$105	\$100
H-36	Sealer	1/2"		2	69	64
H-25		5/8"		2	69	64
H-37		3/4"		2	69	64
H-40		Cutter		3/8 to 3/4"	1	47



H-38 TENSIONER



H-25, H-36, H-37 SEALER

## STANDARD

Uline's best-selling line. Strong and durable. Dependable, heavyweight construction.

MODEL NO.	DESCRIPTION	FITS STRAPPING WIDTH	FITS TENSILE	LBS. EACH	PRICE EACH	
					1	2+
H-242	Tensioner	3/8 to 3/4"	.015 - .023	6	\$153	\$143
H-350	Industrial Sealer	3/8"		3	142	138
H-351		1/2"		3	142	138
H-352		5/8"		3	142	138
H-353		3/4"		3	142	138
H-41	Cutter	3/8 to 1/4"	.015 - .031	2	60	49



H-242 INDUSTRIAL TENSIONER



H-350, 1, 2, 3 INDUSTRIAL SEALER

## INDUSTRIAL

### SPECIAL STEEL TOOL OFFER

SAVE \$100

MODEL NO.	INCLUDES:	SHPG. WT.	REG. PRICE	SALE PRICE
H-622	H-242 Tensioner, Sealer*, H-41 Cutter, and H-279 Deluxe Steel Cart	65 lbs.	<del>\$805</del>	\$705

\* Specify sealer size - 3/8", 1/2", 5/8" or 3/4"



H-279 CART



H-41 INDUSTRIAL CUTTER

Signode strapping compatible. Lightweight and flexible.

MODEL NO.	DESCRIPTION	FITS STRAPPING WIDTH	FITS TENSILE	LBS. EACH	PRICE EACH	
					1	2+
H-1482	Tensioner	3/8 to 3/4"	.015 - .025	4	\$365	\$355
H-662	Deluxe Sealer	1/2"	.015 - .025	3	220	210
H-663		5/8"		3	220	210
H-664		3/4"		3	220	210
H-5687	Safety Cutter	3/8 to 1/4"	.015 - .035	2	89	85



H-1482 DELUXE TENSIONER



H-662, 3, 4 DELUXE SEALER

## DELUXE

### ORGAPACK SEALLESS STEEL TOOL

Tighten, seal and cut with the finest sealless tool on the market.

- Designed for high-volume users.
- 90 day warranty.

Call for more information

Specify size when ordering

MODEL NO.	DESCRIPTION	FITS STRAPPING WIDTH	FITS TENSILE	LBS. EACH	PRICE EACH
H-1067	Sealless Tool	1/2, 5/8 or 3/4"	.014 - .025	8	\$1,195



SEALLESS JOINT - No seals required



H-1067 ORGAPACK SEALLESS TOOL

## ORGAPACK

# STAINLESS STEEL STRAPPING



Premium quality strapping for extreme indoor and outdoor conditions.

- **Type 201** – Stainless steel resists chemicals, salts, heat, cold, moisture, UV light and high temperatures.
- Secure outdoor signs, bundle cables and create custom clamps for hoses and duct work.
- **Type 304** – Corrosion resistant, designed for insulation work and light-duty applications.

## TYPE 201 DISPENSER BOX

SHIPS VIA UPS

MODEL NO.	SIZE	THICKNESS	BREAK STRENGTH	LENGTH	LBS./COIL	PRICE PER COIL		
						1	3	5+
S-11329	1/2"	.030	1,500 lbs.	100'	5	\$75	\$72	\$69
S-11330	3/4"	.030	2,250 lbs.	100'	8	110	105	100

## TYPE 304 DISPENSER BOX

SHIPS VIA UPS

MODEL NO.	SIZE	THICKNESS	BREAK STRENGTH	LENGTH	LBS./COIL	PRICE PER COIL		
						1	3	5+
S-14376	1/2"	.020	600 lbs.	200'	7	\$104	\$100	\$96
S-15342	3/4"	.020	1,275 lbs.	200'	11	136	132	128

## SEALS

MODEL NO.	FITS STRAPPING WIDTH	DESCRIPTION	LBS./CTN.	PRICE/CTN. OF 100		
				1	3	5+
S-11331	1/2"	Seals	2	\$64	\$61	\$58
S-11332	3/4"		4	82	79	76

## TOOL

MODEL NO.	DESCRIPTION	FITS TENSILE	SIZE	LBS./EACH	PRICE EACH	
					1	2+
H-1273	Tensioner	.020 - .030	1/4 - 3/4"	5	\$150	\$140

# ZINC-COATED STEEL STRAPPING

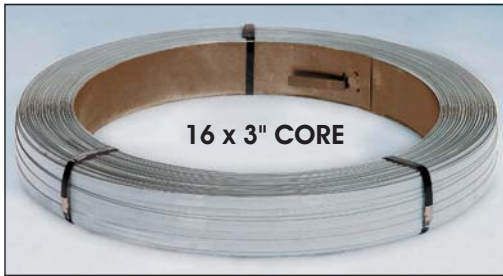

Recommended for lumber, bricks and building supply yards.

- Rust and corrosion resistant – Won't stain loads.



MEETS FED. SPEC. ASTM-D-3953. FINISH C.

MODEL NO.	WIDTH	THICKNESS	BREAK STRENGTH	LENGTH	COILS/SKID	LBS./COIL	PRICE PER COIL			SKID LOTS	USES SEAL
							1	2	6+		
S-11088	1/2"	.020	1,450 lbs.	3,087'	12	105	\$262	\$254	\$247	\$192	S-827
S-12704	3/4"	.025	2,800 lbs.	1,570'			254	246	239		
S-15343*	1 1/4"	.031	5,500 lbs.	836'	24	110	247	239	232	176	S-833

\*RIBBON WOUND

SHIPS VIA MOTOR FREIGHT

# GALVANIZED STEEL STRAPPING



Strap and safely send munitions or dangerous explosives.

- Fights rust and corrosion under the most extreme outdoor conditions.



MEETS FED. SPEC. ASTM-D-3953. FINISH B. GRADE 1.

MODEL NO.	WIDTH	THICKNESS	BREAK STRENGTH	LENGTH	COILS/SKID	LBS./COIL	PRICE PER COIL			SKID LOTS	USES SEAL
							1	2	6+		
S-14380	3/4"	.031	3,500 lbs.	1,280'	12	105	\$340	\$328	\$317	\$233	S-828
S-14381*	1 1/4"	.031	5,500 lbs.	760'	24	120					S-833

\*RIBBON WOUND

SHIPS VIA MOTOR FREIGHT

# STEEL STRAPPING SEALS

FOR STEEL STRAPPING

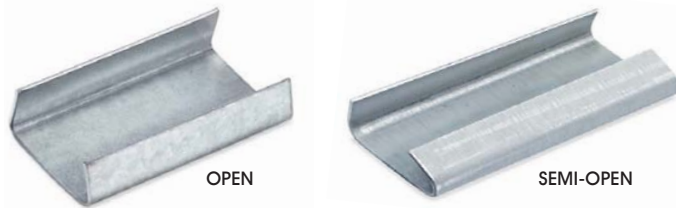

Secure seal guaranteed. High strength carbonized steel.

- **Galvanized** to prevent rust.
- Uline seals work with Signode tools.
- Semi-open: Use only with high tensile sealers.

PUSHER SEALS AND STRAPPING TOOLS, PAGES 300-301

MODEL NO.	TYPE	FITS STRAPPING WIDTH	SEAL LENGTH	LBS./CTN.	PRICE/CTN. OF 1,000			
					1	2	5	10+
S-831	Open	3/8"	1"	6	\$23	\$22	\$21	\$20
S-827		1/2"		6	25	24	23	22
S-832		5/8"		7	29	28	26	25
S-828		3/4"		9	32	31	29	27

MODEL NO.	TYPE	FITS STRAPPING WIDTH	SEAL LENGTH	LBS./CTN.	PRICE/CTN. OF 1,000			
					1	2	5	10+
S-18469	Semi-Open	1/2"	1 3/32"	21	\$47	\$45	\$42	\$39
S-11105		3/4"	1 3/32"	28	54	52	49	45
S-833		1 1/4"	2 7/32"	49	96	92	88	84

# BALING WIRE

## PAINTED HAND TIE – SINGLE LOOP



MODEL NO.	GAUGE	LENGTH	BREAK STRENGTH	TIES PER COIL	LBS./ COIL	PRICE PER COIL		
						1	2	6+
S-18470	14	10'	375 lbs.	250	45	\$164	\$151	\$137
S-14373	14	14'	375 lbs.	250	62	205	190	177
S-21206	13	12'	500 lbs.	250	70	235	221	210
S-14374	13	14'	500 lbs.	250	81	265	251	235
S-21207	12	14'	650 lbs.	125	54	190	177	162
S-14375	12	18'	650 lbs.	125	70	235	221	210
S-15337	12	21'	650 lbs.	125	80	305	287	274
S-22335	11	14'	850 lbs.	62	35	162	149	135
S-15338	11	21'	850 lbs.	62	52	190	177	162

SHIPS VIA MOTOR FREIGHT

## GALVANIZED HAND TIE – SINGLE LOOP



MODEL NO.	GAUGE	LENGTH	BREAK STRENGTH	TIES PER COIL	LBS./ COIL	PRICE PER COIL		
						1	2	6+
S-21707	14	14'	450 lbs.	250	62	\$218	\$205	\$190
S-21708	13	14'	575 lbs.	250	81	278	264	249
S-22336	12	14'	725 lbs.	125	54	204	189	176
S-22337	11	14'	925 lbs.	62	35	179	163	150

SHIPS VIA MOTOR FREIGHT

## AUTOMATIC

MODEL NO.	GAUGE	APPROX. FT./BOX	BREAK STRENGTH	BOXES/ SKID	LBS./ BOX	PRICE PER BOX			SKID LOT
						1	5	10+	
S-18472	12	3,369	630 lbs.	36	100	\$225	\$215	\$205	\$175
S-18473	11	2,582	830 lbs.						
S-18474	10	2,057	970 lbs.						

SHIPS VIA MOTOR FREIGHT



Bundle cardboard, plastics and lumber

Single loop flexible steel wire.

Painted Hand Tie – Nontoxic, protective coating.



- Recommended for baling cardboard, hay and fabrics.
- Easy to hand tie.

Galvanized Hand Tie – Extra strong for binding tires, wood and scrap metals.

- Zinc coating resists rust and corrosion.

Automatic – Continuous black annealed wire for use with horizontal baling machines.



- Wire feeds from box.

AUTOMATIC

# MACHINE STRAPPING

## 8 x 8" CORE (CORE DIAMETER x WIDTH)

MODEL NO.	WIDTH	THICKNESS	BREAK STRENGTH	LENGTH	COLOR	LBS./ COIL	PRICE PER COIL (MIN. 2)		
							2	4	12+
S-12823*	1/4"	.019	175 lbs.	18,000'	Clear	29	\$138	\$133	\$124
S-7455	1/4"	.024	200 lbs.	18,000'	White	28	124	119	116
S-5691	3/8"	.024	300 lbs.	12,900'	White	29	106	102	98
S-13083	3/8"	.024	300 lbs.	12,900'	Clear	29	106	102	98
S-11347	1/2"	.023	350 lbs.	9,900'	Black	27	106	102	98
S-5692	1/2"	.023	350 lbs.	9,900'	White	27	\$84 per coil any qty.		
S-5693	1/2"	.024	450 lbs.	7,200'	White	26	106	102	98
S-6922	1/2"	.020	275 lbs.	9,800'	Clear	24	106	102	98

\* SMOOTH SURFACE

## 9 x 8" CORE (CORE DIAMETER x WIDTH)

S-11348	1/4"	.024	200 lbs.	18,000'	White	28	\$124	\$119	\$116
S-6431	3/8"	.024	300 lbs.	12,900'		29	106	102	98
S-6432	1/2"	.023	350 lbs.	9,900'	White	26	101	97	92
S-6433	1/2"	.024	450 lbs.	7,200'		26	106	102	98



High-quality polypropylene strapping works with all tabletop strapping machines.

- UPSable.
- Embossed surface.

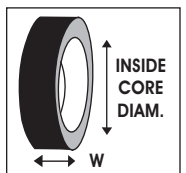

# POLYPROPYLENE STRAPPING MACHINE

Speed up productivity. Dispense, tighten and seal up to 17 straps per minute.

- No seals required.
- All enclosed welded-steel frame. More info, see [uline.com](http://uline.com)

Strapping Widths: 1/4 - 5/8".

Power: 110 volts.

LBS: 10-100 lbs. tension.

Cores: Uses 8 x 8" or 9 x 8" sizes.

Guarantee: 6 month warranty.

Length: Pre-set strapping length from 0-18'.

MODEL NO.	DESCRIPTION	DIMENSIONS L x W x H	SHPG. WT.	PRICE EACH	
				1	2+
H-959	Poly Strapping Machine	37 x 23 x 30"	220 lbs.	\$1,149	\$1,099

SHIPS VIA MOTOR FREIGHT

IN STOCK – SHIPS TODAY





# ULINE POLY STRAPPING TOOLS

## INDUSTRIAL



**H-540: INDUSTRIAL TENSIONER**  
Applies maximum tension instantly with little effort.



**H-57: INDUSTRIAL SEALER**  
1 1/2" handle.

## DELUXE

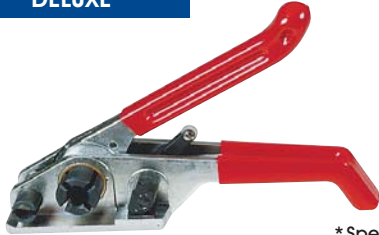

**H-573: DELUXE TENSIONER**  
Heavy-duty zinc casting. Won't break if dropped.



**H-624: DELUXE SEALER**  
Sturdy Swiss design. 18" handle.

\* Specify sealer size when ordering

MODEL NO.	DESCRIPTION	SHPG. WT.	FITS COIL WIDTHS	PRICE EACH	
				1	2+
H-540	Industrial Tensioner	3 lbs.	1/2, 5/8"	\$68	\$66
H-57*	Industrial Sealer	4 lbs.	1/2, 5/8"	44	42
H-573	Deluxe Tensioner	5 lbs.	1/2, 5/8"	155	150
H-624*	Deluxe Sealer	4 lbs.	1/2, 5/8"	205	200
H-39	Strapping Cart	59 lbs.	16 x 3", 16 x 6"	405	395

## SPECIAL TOOL OFFER

**SAVE \$60**

MODEL NO.	DESCRIPTION	SHPG. WT.	<del>REG. PRICE</del>	SALE PRICE
H-602	H-540 Tensioner, H-57 Sealer* and H-39 Strapping Cart	66 lbs.	<del>\$517</del>	<b>\$457</b>

\* Specify sealer size: 1/2" or 5/8"

**H-39 CART**



## POLY STRAPPING SEALS

FOR POLY STRAPPING

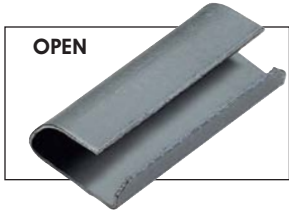

OPEN



SANDPAPER

**ULINE OPEN SEALS** – Galvanized metal seals slide easily over polypropylene strapping.

**SIGNODE SANDPAPER SEALS** – Sandpaper bottom provides extra grip.

- For use with H-812 Signode Sandpaper Sealer only.

MODEL NO.	DESCRIPTION	WIDTH	LENGTH	LBS./ CTN.	PRICE PER CARTON OF 1,000			
					1	3	6	12+
S-512	Open Seal	1/2"	1 1/4"	13	\$36	\$34	\$33	\$30
S-169		5/8"		21	40	37	36	34
S-10477	Sandpaper	1/2"	3/4"	13	101	97	94	89
S-3815			1 1/8"	17	113	108	105	102

H-812	Signode Sandpaper Sealer	Fits Widths 1/2"	\$395 each
-------	--------------------------	------------------	------------

## ULINE CART



Uline's **best-selling** cart. Sturdy and dependable.

- For polypropylene, polyester or steel strapping.
- Fits core sizes 16 x 3" and 16 x 6".
- See page 298 for more info.

MODEL NO.	DESCRIPTION	SHPG. WT.	PRICE EACH	
			1	2+
H-39	Strapping Cart	59 lbs.	\$405	\$395

## ECONOMY CART

All-purpose cart handles core sizes 8 x 8", 16 x 3" and 16 x 6".

- For polypropylene or polyester strapping.
- Lightweight, economical.
- Storage tray for tools and seals.



MODEL NO.	DESCRIPTION	SHPG. WT.	PRICE EACH	
			1	2+
H-566	Polypropylene and Polyester	45 lbs.	\$480	\$470

# ULINE POLY STRAPPING

16 x 6" CORE



- Strong polypropylene strapping is **1/2 the weight of steel strapping.**
- Easier, safer and less expensive to use.
- Embossed surface.

MODEL NO.	WIDTH	THICKNESS	BREAK STRENGTH	LENGTH	COLOR	APPLICATION	LBS./COIL	PRICE PER COIL			
								1	3	6	12+
S-811	1/2"	.015	300 lbs.	9,000'	Black	Individual Cartons	19	\$71	\$68	\$63	\$61
S-1874	1/2"	.015	300 lbs.	9,000'	White		19	92	86	83	80
S-1550	1/2"	.017	300 lbs.	11,400'	Black		23	107	102	98	93
S-1862	1/2"	.020	450 lbs.	7,200'	Black		21	102	97	93	86
S-3844*	1/2"	.020	500 lbs.	7,200'	White		26	121	117	111	106
S-3006*	1/2"	.020	600 lbs.	7,800'	Black		30	139	133	127	120
S-821	1/2"	.024	500 lbs.	7,200'	Black	Skids up to 2,000 lbs.	27	\$85 per coil any quantity			
S-18508	1/2"	.024	500 lbs.	7,200'	White		27	121	117	111	106
S-1029	1/2"	.024	500 lbs.	7,200'	Yellow		27	121	117	111	106
S-162	1/2"	.027	600 lbs.	7,200'	Black	Heavy Loads	30	127	121	117	111
S-2377	1/2"	.029	750 lbs.	5,600'			27	127	121	117	111
S-3245	5/8"	.020	500 lbs.	6,000'	Black	Extra Heavy Skids	23	116	109	104	99
S-163	5/8"	.025	600 lbs.	6,000'			25	133	127	121	117
S-2378	5/8"	.030	820 lbs.	6,000'			30	140	134	129	121

\*Smooth surface

## SIGNODE COMPARABLE STRAPPING

16 x 6" CORE

- Smooth surface. Virgin resin.
- 16 x 6" core.

MODEL NO.	SIGNODE COMPARABLE	WIDTH	THICKNESS	BREAK STRENGTH	LENGTH	COLOR	LBS./COIL	PRICE PER COIL			
								1	3	6	12+
S-3307	816	1/2"	.022	500 lbs.	8,000'	Black	33	\$152	\$144	\$138	\$129
S-3308	818	1/2"	.026	600 lbs.	7,000'		33	155	149	141	133



Call for competitive quotes on volume purchases, specialty tools and semi-automatic machines.

## POLY STRAPPING AND CART

8 x 8" CORE

- High-quality Uline Polypropylene Strapping fits 8 x 8" core carts.
- H-349 Cart – **Strapping brake** keeps coil from unwinding. Storage compartment for tools. **Lightweight**, easy to move. Fits 8 x 8" core.



MODEL NO.	WIDTH	THICKNESS	BREAK STRENGTH	LENGTH	LBS./COIL	PRICE PER COIL			USES SEAL
						1	3	6+	
S-1761	1/2"	.015	300 lbs.	9,000'	19	\$94	\$86	\$80	S-512
S-1758	1/2"	.020	450 lbs.	7,200'	21	118	110	102	
S-14198	1/2"	.024	500 lbs.	7,200'	28	127	118	109	
S-2679	1/2"	.031	600 lbs.	7,200'	30	144	133	122	
S-2680	5/8"	.020	500 lbs.	6,000'	23	140	130	119	S-169
S-2999	5/8"	.025	600 lbs.	6,000'	25	142	133	120	
S-3524	5/8"	.030	820 lbs.	6,000'	30	146	136	126	



POLYPROPYLENE STRAPPING CART

MODEL NO.	SHPG. WT.	PRICE EACH
H-349	35 lbs.	\$395

# ORGAPACK SEALLESS COMBO TOOLS

FOR POLYPROPYLENE AND POLYESTER STRAPPING



H-10933



H-7207/H-7211



LED Touch Screen

NEW TECHNOLOGY



H-7212

Completely re-engineered for enhanced handling and performance.

**Semi-Automatic.** Combines manual tensioning with battery-powered automatic sealing.

- Handles 3/8, 1/2, 5/8 and 3/4" strapping.
- 12V Li-ion battery – Up to 750 seals per charge. 95-min. recharge.
- Good for up to 2,000 charges.
- Touchpad for easy weld time adjustments.

**Automatic.** Easy, one-handed tensioning, sealing and cutting.

- Secure bricks, drums and pallets with these robust tools.
- 18V Li-ion battery – Up to 800 seals per charge. Quick, 35-min. recharge.
- Good for up to 3,000 charges.
- LED touch screen with protective bumper sets exact tension and weld time.

**Light-Duty Automatic.** 6% lighter. Used for fragile packages.

- Stabilize glass shipments or electronics.
- 18V Li-ion battery – Up to 800 seals per charge. Quick, 30-min. recharge.
- Good for up to 3,000 charges.
- LED touch screen with protective bumper sets exact tension and weld time.

## SEALLESS COMBO TOOLS

Includes 1 battery and 1 charger

MODEL NO.	DESC.	TYPE	FITS STRAPPING WIDTHS	FOR STRAPPING THICKNESS	TENSION CAPACITY	WT. (LBS.)	PRICE EACH	
							1	2+
H-10933	ORT55	Semi-Automatic	3/8, 1/2, 5/8, 3/4"	.016 - .035	510 lbs.	8.3	\$1,950	\$1,900
H-7207	ORT260	Automatic	1/2, 5/8"	.019 - .040	560 lbs.	8.4	3,750	3,700
H-7211	ORT450		5/8, 3/4"	.031 - .051	1,010 lbs.	9.5	4,025	3,950
H-7212	ORT130	Light-Duty Automatic	3/8, 1/2"	.014 - .024	270 lbs.	7.9	3,575	3,525

## EXTRA BATTERIES

MODEL NO.	PRICE EACH	
	1	2+
H-10933-BATT	\$240	\$230
H-7207-BATT	250	240
H-2386-BATT	380	370
H-7207-BATT	250	240

# ULINE POLYESTER STRAPPING TOOLS

## INDUSTRIAL



### H-572: INDUSTRIAL TENSIONER

Applies maximum tension instantly with little effort.



### H-702, H-703: INDUSTRIAL GRIPPER SEALERS

Specially designed to work with Gripper Seals. 17" handle.

## DELUXE

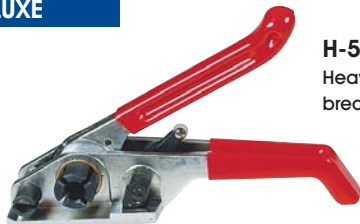

### H-573: DELUXE TENSIONER

Heavy-duty zinc casting. Won't break if dropped.



### H-779, H-780: ORGAPACK GRIPPER SEALERS

Sturdy Swiss design. 18" handle.

MODEL NO.	DESCRIPTION	FITS COIL WIDTHS	PRICE EACH		
			1	2	4+
H-572	Industrial Tensioner	1/2, 5/8"	\$79	\$77	\$74
H-702 H-703	Industrial Gripper Sealers	1/2" 5/8"	90	85	80
H-573	Deluxe Tensioner	1/2, 5/8"	155	150	145
H-779 H-780	Deluxe Gripper Sealers	1/2" 5/8"	245	240	235

## SPECIAL TOOL OFFER

SAVE \$80

MODEL NO.	DESCRIPTION	SHPG. WT.	REG. PRICE	SALE PRICE
H-773	H-572 Tensioner, H-702 Sealer* and H-39 Strapping Cart	68 lbs.	<del>\$574</del>	\$494

\* Specify sealer size – 1/2" or 5/8"



H-39 CART



# ULINE POLYESTER STRAPPING

16 x 3" CORE

SOLD ONLY IN CARTON QUANTITIES

MODEL NO.	WIDTH	THICKNESS	BREAK STRENGTH	LENGTH	COLOR	LBS./COIL	PRICE PER COIL (2 COILS PER CTN.)		
							2	4	6+
S-1657	1/2"	.015	500 lbs.	4,500'	Black		\$82	\$77	\$62
S-1240	1/2"	.020	600 lbs.	3,600'	Black		84	78	65
S-6481	1/2"	.020	600 lbs.	3,600'	Green	21	90	83	71
S-1654	1/2"	.025	775 lbs.	2,900'	Black		85	81	68
S-3247	1/2"	.025	775 lbs.	2,900'	Green		95	85	74
<b>S-1243</b>	<b>1/2"</b>	<b>.028</b>	<b>820 lbs.</b>	<b>3,250'</b>	<b>Black</b>	<b>25</b>	<b>\$76 per coil any quantity</b>		
S-3248	1/2"	.028	820 lbs.	3,250'	Green	25	107	98	83
S-1655	5/8"	.020	750 lbs.	2,850'	Black	21	82	77	62
S-1241	5/8"	.025	900 lbs.	2,200'	Black	20	84	79	67
S-6482	5/8"	.025	900 lbs.	2,200'	Green	20	90	83	71
<b>S-1656</b>	<b>5/8"</b>	<b>.030</b>	<b>1,100 lbs.</b>	<b>1,800'</b>	<b>Black</b>	<b>21</b>	<b>\$65 per coil any quantity</b>		



16 x 6" CORE

MODEL NO.	WIDTH	THICKNESS	BREAK STRENGTH	LENGTH	COLOR	LBS./COIL	PRICE PER COIL (1 COIL PER CTN.)		
							1	2	6+
S-6681	1/2"	.020	600 lbs.	7,200'	Black	42	\$156	\$134	\$122
S-13024	1/2"	.020	600 lbs.	7,200'	Green	42	156	134	122
S-15350	1/2"	.025	775 lbs.	5,800'	Black	46	159	143	131
S-12530	1/2"	.028	820 lbs.	6,500'	Black	50	161	146	132
S-3249	5/8"	.030	1,100 lbs.	3,600'	Black	41	155	133	121
S-2386	5/8"	.035	1,400 lbs.	4,200'	Black	53	163	149	134
<b>S-3250</b>	<b>5/8"</b>	<b>.035</b>	<b>1,400 lbs.</b>	<b>4,200'</b>	<b>Green</b>	<b>53</b>	<b>\$133 per coil any quantity</b>		
S-11349	5/8"	.040	1,600 lbs.	4,000'	Green	57	177	162	150
S-14367	3/4"	.035	1,750 lbs.	3,500'	Green	57	190	177	161
S-12531*	3/4"	.040	1,900 lbs.	3,000'	Green	55	190	177	161

\*AAR approved

Replaces steel strapping for medium and heavy-duty applications.

- 70% less expensive than steel.
- 80% lighter, easier to use.
- Less elongation than poly, more flexibility than steel.
- S-2386, S-3250, S-11349, S-14367 and S-12531 strong hand grades recommended for lumber and bricks.
- S-6681 and S-13024 over twice the length of standard coils.
- S-12531 break strength 1,900 lbs.

## SIGNODE COMPARABLE STRAPPING

16 x 6" CORE

MODEL NO.	SIGNODE COMPARABLE	WIDTH	THICKNESS	BREAK STRENGTH	LENGTH	COLOR	LBS./COIL	PRICE PER COIL		
								1	2	6+
S-2701	1716	7/16"	.021	500 lbs.	10,500'	Green	53	\$189	\$183	\$160
S-3855	1816	1/2"	.018	500 lbs.	10,500'		55	196	187	165
S-3000	1818	1/2"	.021	600 lbs.	9,000'		53	196	187	165
S-3001	1822	1/2"	.028	800 lbs.	6,500'		51	188	182	159

## POLYESTER STRAPPING SEALS

HIGHLY RECOMMENDED

ULINE GRIPPER SEALS – Specially designed inside treads grip polyester strapping. For use with gripper sealers only.

SIGNODE SANDPAPER SEALS – Sandpaper bottom provides extra grip. For use with H-812 sealer only.

MODEL NO.	DESCRIPTION	WIDTH	LENGTH	LBS./CTN.	PRICE PER CARTON OF 1,000			
					1	3	6	12+
S-2157	Gripper	1/2"	1 1/4"	13	\$81	\$78	\$75	\$71
S-2158		5/8"		20	100	95	91	85
S-10477	Sandpaper	1/2"	3/4"	13	101	97	94	89
S-3815			1 1/8"	17	113	108	105	102

H-812	Signode Sandpaper Sealer	Fits Widths 1/2"	\$395 each
-------	--------------------------	------------------	------------



## ORGAPACK COMBO TOOL

USE WITH GRIPPER SEALS ONLY

Lightweight and highly efficient. Use with polypropylene and polyester strapping.

- 3-in-1 Tool: Tensions, applies seals and cuts strapping.

MODEL NO.	DESCRIPTION	FITS STRAPPING WIDTHS	FOR STRAPPING THICKNESS	PRICE EACH	
				1	2+
H-771	Single Lever	1/2"	.016 - .028	\$1,020	\$995
H-1275		5/8"	.020 - .040	1,455	1,425



# FROMM SEALLESS COMBO TOOLS



**Automatic.** Rugged and well balanced for easy handling.

- 2 powerful 18V motors – 1 for tensioning, 1 for sealing and cutting.
- Lithium ion battery – Up to 600 seals per charge. Lasts up to 3,000 charges.
- Fasten coils, pipes and irregular-shaped packages.
- Easy-to-adjust tension and weld-time knobs.

FOR POLYPROPYLENE AND POLYESTER STRAPPING, see pages 305-307.

## SEALLESS COMBO TOOLS

MODEL NO.	DESCRIPTION	TYPE	FITS STRAPPING WIDTHS	FOR STRAPPING THICKNESS	TENSION CAPACITY	WT. (LBS.)	PRICE EACH	
							1	2+
H-5908	P328	Automatic	1/2"	.016 - .025	585 lbs.	9.6	\$3,850	\$3,800
H-5909 H-7184	P329	Automatic	5/8" 3/4"	.025 - .041	900 lbs.	9.8	4,175	4,100

Includes 1 battery and 1 charger

## EXTRA BATTERIES

MODEL NO.	PRICE EACH	
	1	2+
H-2614-BATT	\$240	\$235
H-2614-BATT		
H-2614-BATT		

## POLY CORD STRAPPING



## HAND TIE

## LIGHT-DUTY APPLICATIONS

Woven polyester combines strength and shock resistance.

- Hand tie for light-duty applications. Use buckles for heavy-duty applications.
- Secure products throughout the warehouse easily with this lightweight cord strapping.

### DISPENSER BOX

MODEL NO.	SIZE	BREAK STRENGTH	PRICE EACH		
			1	2	6+
S-5463	3/8" x 1,125'	500 lbs.	\$39	\$38	\$37

### STRAPPING

MODEL NO.	SIZE	BREAK STRENGTH	PRICE PER COIL		
			1	4	8+
S-5002	1/2" x 3,900'	700 lbs.	\$122	\$117	\$112
S-6434	5/8" x 3,000'	850 lbs.	113	108	103



## HEAVY DUTY

## OUTDOOR APPLICATIONS

Secure lumber, bricks and building materials.

- Ultra weather resistant.
- Combines the strength of steel and advantages of poly strapping.
- Excellent shock resistance.
- Won't scratch or damage surfaces.
- Use buckles and tools for heavy-duty applications.

### HEAVY DUTY STRAPPING

MODEL NO.	SIZE	BREAK STRENGTH	COLOR	PRICE PER COIL		
				1	4	8+
S-21351	3/4" x 2,100'	1,050 lbs.	White	\$117	\$112	\$107
S-12925	3/4" x 2,500'	1,475 lbs.	Yellow	150	144	138
S-12926	3/4" x 1,650'	2,400 lbs.	Orange	145	139	133
S-12927*	1 1/4" x 660'	3,250 lbs.	White	111	106	101
S-18506*	1 1/2" x 600'	4,400 lbs.	Yellow	122	117	112

\* RIBBON WOUND

### METAL BUCKLES

MODEL NO.	STRAPPING SIZE	GAUGE	QTY./ BOX	PRICE PER BOX		
				1	2	4+
S-108	1/2"	.105	1,000	\$52	\$50	\$48
S-12928	5/8"	.120	1,000	67	65	63
S-12929*	3/4"	.160	1,000	142	137	132
S-12930*	1 1/4"	.240	250	135	130	125
S-18507*	1 1/2"	.280	150	125	120	115

\* PHOSPHATE COATED FOR SUPERIOR STRENGTH

### POLY CORD TOOLS

MODEL NO.	DESCRIPTION	FITS COIL WIDTHS	SHIPPING WEIGHT	PRICE EACH	
				1	2+
H-1586	Tensioner	1/2 - 3/4"	3 lbs.	\$69	\$67
H-1587		1 1/4 - 1 1/2"	5 lbs.	515	490
H-1624	Poly Cord Cart		31 lbs.	370	360

# ULINE POLYPROPYLENE STRAPPING KITS

400 LB. BREAK STRENGTH



## GENERAL PURPOSE KITS INCLUDE METAL BUCKLES

MODEL NO.	DESCRIPTION	BUCKLES	BUCKLE QTY.	SIZE	BREAK STRENGTH	PRICE EACH	
						1	3+
S-107	General Purpose	Metal	300	1/2" x .021 x 3,000'	400 lbs.	\$77	\$71
S-1717	Jumbo General Purpose		1,000	1/2" x .021 x 9,000'		176	166

Easy-to-use, **portable** polypropylene strapping kits will secure skids, boxes and tubing anywhere in the warehouse.

## POSTAL APPROVED KITS INCLUDE REQUIRED PLASTIC BUCKLES

S-3823	Postal Approved	Plastic	300	1/2" x .021 x 3,000'	400 lbs.	\$77	\$71
S-3824	Jumbo Postal Approved		1,000	1/2" x .021 x 9,000'		176	166

- Choose from general purpose or Postal approved kits.
- Each kit includes a tensioner/cutter.

## EXTRA BUCKLES

### FOR POLY STRAPPING

Loop polypropylene strapping through buckles.

- Use H-348 combo tool to tighten and cut.
- Additional buckles, see page 308.



MODEL NO.	DESCRIPTION	SIZE	QTY./ BOX	PRICE PER BOX	
				1	4+
S-257	Plastic Buckles	1/2"	1,000	\$35	\$33
S-108	Metal Buckles			52	48
S-12709	Heavy Duty Metal Buckles			62	58

## TIGHTENER/CUTTER

COMBO TOOL

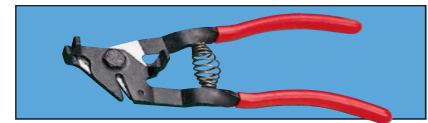

For **polypropylene strapping kits** to tighten and cut off excess strapping.

MODEL NO.	FITS STRAPPING WIDTHS	LBS. EACH	PRICE EACH	
			1	2+
H-348	3/8, 1/2, 5/8"	3	\$56	\$50

## PORTABLE STEEL COIL

Portable dispenser box for **on-the-spot jobs**.

- Lightweight, easy to use.
- Signode tool compatible.

\* Super Duty

MODEL NO.	WIDTH	THICKNESS	BREAK STRENGTH	LENGTH	LBS./ COIL	PRICE PER COIL		
						1	2	6+
S-5462*	1/2"	.017	1,305 lbs.	300'	10	\$45/coil any qty.		
S-824		.020	1,180 lbs.		\$52	\$51	\$49	
S-12705	5/8"	.020	1,470 lbs.		13	50	49	47
S-11264*	3/4"	.017	1,630 lbs.		15	50	49	47
S-18468		.023	1,985 lbs.	18	59	58	56	

## DISPENSER BOX



## MAIL TRAY STRAPPING MEETS POSTAL REQUIREMENTS

- Quick and easy – No tools required.
- Wrap around tray, tighten and cut.
- Specially designed dispenser box keeps coils from unraveling.

MODEL NO.	WIDTH	LENGTH	TENSILE STRENGTH	QTY./ CARTON	PRICE PER CARTON		
					1	5	10+
S-3919	9/16"	500'	80 lbs.	2	\$52	\$50	\$48





# ROPE

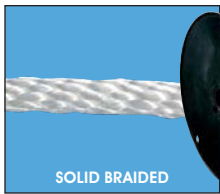

## NYLON

Shock absorbent. Recommended for securing boats, cargo and furniture.

- Strong, abrasion resistant.
- Flexible, easy to knot.
- Won't rot or mildew.
- Resists oils, gas and most chemicals.



BLACK SOLID BRAIDED

**Solid Braided** – Smooth. Works well in pulleys.



TWISTED

**Twisted** – General, all-purpose rope. Easy to grip and splice.



DOUBLE BRAIDED

**Double Braided** – A rope within a rope. Extra strong for towing and anchor lines.

### SOLID BRAIDED NYLON – WHITE

MODEL NO.	DIAMETER	TENSILE STRENGTH	LENGTH	SAFE LOAD	PRICE EACH		
					1	3	5+
S-12866	1/8"	320 lbs.	500'	50	\$20	\$19	\$18
S-17650	3/16"	620 lbs.		85	37	36	34
S-12867	1/4"	1,150 lbs.		155	47	45	43
S-21186	5/16"	1,620 lbs.		225	80	78	76
S-12868	3/8"	2,300 lbs.	500'	315	113	109	105
S-14196	1/2"	3,900 lbs.	500'	525	191	185	179
S-17652	5/8"	6,000 lbs.	500'	850	331	315	299

### SOLID BRAIDED NYLON – BLACK

MODEL NO.	DIAMETER	TENSILE STRENGTH	LENGTH	SAFE LOAD	PRICE EACH		
					1	3	5+
S-15354	1/8"	320 lbs.	500'	50	\$29	\$28	\$27
S-21187	3/16"	620 lbs.		85	44	43	42
S-17651	1/4"	1,150 lbs.		155	68	65	62
S-21188	5/16"	1,620 lbs.		225	91	87	83
S-21189	3/8"	2,300 lbs.	500'	315	145	141	137
S-21190	1/2"	3,900 lbs.	500'	525	233	227	221

### TWISTED NYLON

MODEL NO.	DIAMETER	TENSILE STRENGTH	LENGTH	SAFE LOAD	PRICE EACH		
					1	3	5+
S-18516	1/4"	1,480 lbs.	600'	205	\$68	\$65	\$62
S-18517	3/8"	3,240 lbs.		450	147	142	137
S-18518	1/2"	5,670 lbs.		790	261	251	241

### DOUBLE BRAIDED NYLON

MODEL NO.	DIAMETER	TENSILE STRENGTH	LENGTH	SAFE LOAD	PRICE EACH		
					1	3	5+
S-21213	1/4"	1,650 lbs.	600'	235	\$113	\$110	\$107
S-21214	3/8"	3,700 lbs.		525	205	200	195
S-18519	1/2"	6,500 lbs.		925	295	285	275
■S-18520	3/4"	14,500 lbs.		2,050	635	620	605
■S-18521	1"	25,000 lbs.		3,570	1,210	1,180	1,150

■ SHIPS VIA MOTOR FREIGHT

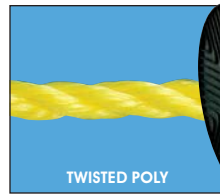

## POLYPROPYLENE

The only rope that floats. Use for dock lines, pools, watersports.

- Highly visible and lightweight.
- Resists rot, mildew, moisture and chemicals.



CALIFORNIA TRUCK ROPE S-14195



HOLLOW BRAID

**Hollow Braid** – Super flexible, smooth diamond weave. Mark swimming lanes and anchor buoys.

### TWISTED POLYPROPYLENE

\* SPECIFY COLOR: Yellow, Black or White

MODEL NO.	DIAMETER	TENSILE STRENGTH	LENGTH	SAFE LOAD	PRICE EACH		
					1	3	5+
S-17657	3/16"	650 lbs.	1,200'	90	\$38	\$37	\$35
S-12863*	1/4"	1,150 lbs.	600'	155	29	28	27
S-12864*	3/8"	2,450 lbs.	600'	330	63	61	59
S-12865*	1/2"	3,800 lbs.	600'	520	106	103	100
S-14193	5/8"	5,600 lbs.	600'	780	162	156	151
S-14194	3/4"	7,650 lbs.	600'	1,050	235	227	219
■S-17658*	1"	12,800 lbs.	600'	1,800	398	383	368
S-14195	3/8"	2,450 lbs.	600'	330	73	67	62

S-14195 CA APPROVED TRUCK ROPE

■ SHIPS VIA MOTOR FREIGHT

### HOLLOW BRAID POLYPROPYLENE

S-15871	3/16"	450 lbs.	1,000'	65	\$33	\$32	\$30
S-15872	1/4"	1,000 lbs.	500'	140	22	21	20
S-15873	3/8"	2,100 lbs.	500'	300	47	45	43

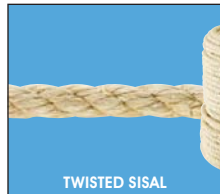

TWISTED SISAL

## SISAL

Economical. Bundling for home, farm or shipping.

- Moderate strength. Pliable.
- Easy to grip and knot.

MODEL NO.	DIAMETER	TENSILE STRENGTH	LENGTH	SAFE LOAD	PRICE EACH		
					1	3	5+
S-18522	1/4"	385 lbs.	1,500'	50	\$98	\$94	\$90
S-18523	3/8"	865 lbs.	500'	115	69	65	62
S-18524	1/2"	1,700 lbs.	500'	225	131	127	119



TWISTED MANILA

## MANILA

Strongest natural fiber rope. For construction or landscaping.

- Resistant to abrasion and stretching. Knots easily.

MODEL NO.	DIAMETER	TENSILE STRENGTH	LENGTH	SAFE LOAD	PRICE EACH		
					1	3	5+
S-18528	1/4"	540 lbs.	1,200'	75	\$85	\$82	\$79
S-18529	3/8"	1,200 lbs.	600'	170	91	88	84
S-18530	1/2"	2,350 lbs.	600'	325	164	158	152
■S-21252	3/4"	4,860 lbs.	600'	690	365	355	345
■S-21253	1"	8,100 lbs.	600'	1,150	575	555	535

■ SHIPS VIA MOTOR FREIGHT

# POLYPROPYLENE TWINE



Soft and easy on hands.

- Knots easily, holds tightly, won't become brittle.
- Resists rot, mildew, moisture and most acids.
- Recommended for industrial packaging and bundling.

## PARCEL HANDLES

MODEL NO.	DESCRIPTION	TENSILE STRENGTH	LENGTH	LBS./ BOX	PRICE PER BOX		
					1	3	5+
H-120	1-Ply Polypropylene	110 lbs.	10,500'	10	\$44 per box any qty.		
H-774		145 lbs.	8,500'				
H-667		210 lbs.	5,500'				
H-1171		325 lbs.	3,500'				
S-15303	2-Ply Polypropylene	315 lbs.	4,200'	10	\$65	\$63	\$61
S-15304		490 lbs.	2,650'				
S-12671	3-Ply Polypropylene	480 lbs.	2,800'	10	66	64	62
S-12672		725 lbs.	1,800'				

**PARCEL HANDLES:** Use on packages wrapped with tying twine.

MODEL NO.	DESCRIPTION	QUANTITY	LBS./ BOX	PRICE PER BOX		
				1	3	5+
S-1180	Parcel Handles	1,000	23	\$150	\$148	\$146



# TYING TWINE



COTTON

Light duty, versatile. Tie up small boxes, bundle newspapers.

- Forms tight, strong knots.
- Soft, extremely flexible.

2.5 LBS.

MODEL NO.	PLY	TENSILE STRENGTH	LENGTH	PRICE EACH		
				1	3	5+
S-12841	8	20 lbs.	6,300'			
S-15352	12	30 lbs.	4,200'	\$19	\$18	\$17
S-12842	16	40 lbs.	3,100'			



JUTE

Medium duty, all purpose. Wrap parcels, brace tomato plants.

- Twisted, natural fibers.
- Soft and easy to use.

10 LBS.

MODEL NO.	PLY	TENSILE STRENGTH	LENGTH	PRICE EACH		
				1	3	5+
S-15339	3	84 lbs.	5,000'			
S-15340	4	110 lbs.	3,700'	\$31	\$30	\$29
S-15341	5	140 lbs.	3,000'			



SISAL

Heavy duty, multiple use. Secure large cartons, bale heavy recycling.

- Natural fibers grip tightly for exceptional knot strength.

10 LBS.

MODEL NO.	PLY	TENSILE STRENGTH	LENGTH	PRICE EACH		
				1	3	5+
S-12843	1	190 lbs.	3,000'			
H-776	2	360 lbs.	1,460'	\$36	\$35	\$34
S-15353	3	460 lbs.	970'			

# NUMBERED CONES

Identify outbound shipments and customer pickups.

- Numbered or lettered on 4 sides for 360° visibility.
- Durable, high-impact plastic.
- Nestable and stackable.
- S-21302 in Yellow.



\* SPECIFY COLOR: Yellow, Green or Red

MODEL NO.	STYLE	BASE SIZE W x L	QTY./ CTN.	PRICE PER CARTON		
				1	3	6+
S-21300*	Numbers 1-20	4½ x 4½"	20	\$175	\$165	\$155
S-21301*	Numbers 21-40					
S-21302	Letters A-Z			26	195	185

# MAGNETIC CONES

Mark vehicles at auctions and dealerships.

- 3 heavy-duty magnets.
- 3 dry erase panels for your messages.
- 360° visibility. 3-sided triangular shape.
- Sturdy, durable polypropylene.



SPECIFY COLOR: Red, Yellow, White, Green, Blue, Orange or Black

MODEL NO.	SIZE DIAM. x H	PANEL SIZE W x H	PRICE EACH (MIN. 5)		
			5	10	50+
S-20671	10 x 5"	6 x 5"	\$12	\$11	\$10

# FOAM PROTECTORS

WON'T SCRATCH SOFT SURFACES



**FRAME:** Prevents damage to valuables during transport. Won't scratch sensitive surfaces.

**CORNER:** Provides a durable shock barrier between inner and master cartons.

**EDGE:** Provides protection inside or outside containers.

- 48" lengths have 6" breakaway sections.

**SHEET:** Full surface shield. Line cartons to insulate and secure soft surface products.



Foam Shipping Containers, pages 53-55.  
Packaging Foam, pages 763, 772-779.

MODEL NO.	STYLE	SIZE L x W x H	THICKNESS	QTY./CTN.	PRICE PER CARTON	
					1	5+
S-6066	Frame	4½ x 1¼ x 4½"	¾"	440	\$212	\$202
S-6064	Corner	3¾ x 3 x 2"	¾"	288	76	70
S-6065	Edge	4 x 4 x 48"	¾"	34	87	81
S-6718	Sheet	12 x 12 x 1"	1"	104	78	76

# CORRUGATED PROTECTORS

## CORNER

Protect furniture and equipment during shipment or storage.



- 2-ply thickness absorbs impact.
- Band or shrink-wrap onto packages.

## FRAME

Safeguard picture frames and mirrors from scratches.

- Ships flat, assembles in seconds.
- Fits frames up to 1" thick.



## MULTI-DEPTH

Fits multiple frame sizes.

- Ships flat, pre-scored for easy assembly.



**S-12246** – Fits frames 1/2 to 2" thick.

**S-21280** – Fits frames 2½ to 4" thick.

MODEL NO.	SIZE	QTY./CTN.	PRICE PER CARTON	
			1	3+
S-8473	4 x 4"	200	\$81	\$73

MODEL NO.	SIZE	QTY./CTN.	PRICE PER CARTON	
			1	3+
S-8474	4 x 4"	400	\$54	\$50

MODEL NO.	SIZE	QTY./CTN.	PRICE PER CARTON	
			1	3+
S-12246	4 x 4"	400	\$50 per carton	
S-21280			\$85	\$77

# INVENTORY CONTROL CONES



Successfully cross-dock, use in quality control or inventory.

- 360° visibility. 3-sided triangular shape.
- Sturdy, durable polypropylene.
- 2" opening at top holds job tickets or packing lists.
- S-20136 Laser Labels, page 235.

SPECIFY COLOR: Red Yellow White Green Blue Orange Purple Black

MODEL NO.	SIZE DIAMETER x H	PANEL SIZE W x H	PRICE EACH (MIN. 5)		
			5	10	50+
S-17321	10 x 5"	6 x 5"	\$5.50	\$5.25	\$5.00

# EDGE PROTECTOR CUTTER

Customize edge protectors to the exact length you need.

- Recommended for shipping uniquely sized items.
- Safety shields on both sides protect fingers.
- Stainless steel blades last up to 5,000 cuts.



Includes set of replacement blades

MODEL NO.	MAX. SIZE	MAX. THICKNESS	SHPG. WT.	PRICE EACH	
				1	2+
H-7191	3 x 3"	.225"	17 lbs.	\$485	\$460



# STRAPPING PROTECTORS

Protect packages from surface damage.

- Made of sturdy laminated fiberboard.
- Strong enough to hold steel and plastic strapping.
- Strapping tension is spread across a wider area.

MODEL NO.	SIZE D x L x W	THICKNESS	QTY./CTN.	SHPG. WT. PER CTN.	PRICE PER CARTON		
					1	5	10+
S-2032	2 x 2 x 3"	.120	1,000	44 lbs.	<b>\$80 per carton</b>		
S-21289	2 x 2 x 4"		850	35 lbs.	\$86	\$79	\$73
S-2518	2 x 4 x 3"		770	58 lbs.	96	88	82
S-3185	2 x 2 x 6"		800	59 lbs.	150	139	128
S-780	3 x 3 x 2½"		1,275	68 lbs.	130	118	108
S-797	2 x 2 x 3"	.160	875	48 lbs.	92	84	77
S-2519	2 x 4 x 3"		650	56 lbs.	101	92	85
S-2520	3 x 3 x 3"		720	55 lbs.	108	98	92
S-2876	3 x 3 x 4"		480	48 lbs.	95	86	80
S-2458	3 x 3 x 6"		400	66 lbs.	130	119	114
S-3216	2 x 2 x 2½"	.225	600	40 lbs.	88	79	74
S-3217	2½ x 2½ x 4"		300	35 lbs.	77	71	65
S-3218	3 x 3 x 2½"		450	42 lbs.	81	76	69
S-3219	3 x 3 x 3"		450	50 lbs.	95	85	80

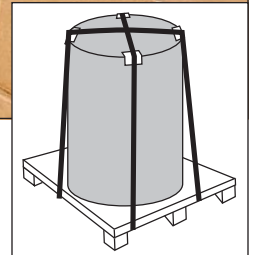

Withstands maximum strap tension while protecting pallet edges.

# STRAP GUARDS

Prevent damage to tightly strapped shipments.

- Ribbed channel keeps steel or plastic strapping from slipping.

MODEL NO.	SIZE D x L x W	STRAPPING MAX. WIDTH	QTY./CTN.	COLOR	PRICE PER CARTON		
					1	5	10+
S-764	1 x 1 x 1½"	3/4"	1,000	White	\$57	\$56	\$55
S-3474	1¾ x 1¾ x 2½"	1¼"	1,000	Black	102	100	98
S-765	2 x 2 x 2½"	1¼"	1,000	White	140	137	134
S-3843	2 x 2 x 5¼"	1¼"	250	Black	91	89	87

**DURABLE PLASTIC**



# U-CHANNEL FOAM



Protect delicate edges.

- Flexible foam conforms to curves.
- Won't scratch finishes. Nonabrasive.

- Fits 1¼" thick products. Cut to size.

## EDGE PROTECTORS

MODEL NO.	LENGTH	QTY./CTN.	PRICE PER CARTON	
			1	5+
S-22506	72"	16	\$145	\$130

# "DO NOT DOUBLE STACK"

**EDGE PROTECTORS**

Printed edge protectors alert carriers and ensure proper handling of shipments.

- Strong fiberboard construction.
- Available in skid quantities.

MODEL NO.	SIZE		THICKNESS	QTY./CTN.	BOARDS/SKID	PRICE PER CARTON			SKID LOT
	1	5				10+			
S-5505	2 x 2"	36"	.160	100	2,240	\$157	\$150	\$140	\$1,857
S-5506	2 x 2"	48"	.160	80	2,240	167	156	146	2,476
S-5507	3 x 3"	36"	.160	65	1,600	138	125	119	1,865
S-5508	3 x 3"	48"	.160	45	1,600	128	120	112	2,487



**LIGHT:** Use with stretch wrap to protect products in storage and during shipping.

**MEDIUM:** Use to stabilize loads and improve stacking strength when shipping.

**HEAVY:** Use with strapping on skids over 2,500 lbs.

**SHIPPING SAVINGS** – Ships from Chicago, Atlanta, Dallas, Los Angeles, Miami, Minneapolis, NYC/Phila, Reno or Seattle.



**SKID LOT SPECIAL**  
SAVE UP TO 55%  
ON SKID QUANTITIES

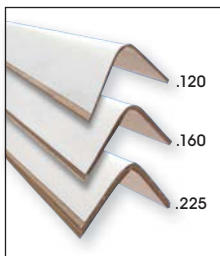

**MEDIUM DUTY**

MODEL NO.	SIZE		THICK-NESS	QTY./CTN.	BOARDS/SKID	APPROX. WT./CTN.	PRICE PER CARTON			SKID LOT
							1	5	10+	
S-21273	3 x 3"	30"	.160	80	1,600	62 lbs.	\$128	\$120	\$113	\$1,494
S-6062		36"		65	1,600	65 lbs.	120	113	104	1,793
S-21274		40"		55	1,600	60 lbs.	116	107	102	1,992
S-6063		48"		45	1,600	58 lbs.	116	107	102	2,390
S-8485		60"		25	1,600	43 lbs.	79	73	68	2,988
S-15205		72"		20	800	40 lbs.	77	71	66	1,793
■S-5510		144"		400	800	1,536 lbs.	1/2 skid bulk shpd. \$1,882			3,585

**HEAVY DUTY**

MODEL NO.	SIZE		THICK-NESS	QTY./CTN.	BOARDS/SKID	APPROX. WT./CTN.	PRICE PER CARTON			SKID LOT		
							1	5	10+			
S-15206	2 x 2"	12"	.225	120	3,080	36 lbs.	\$79	\$73	\$68	\$1,193		
S-15207		24"		60	1,540	32 lbs.	79	73	68	1,124		
S-21275		30"		65	1,540	49 lbs.	119	113	106	1,404		
S-3859		36"		70	1,540	60 lbs.	163	154	143	1,685		
S-15208		40"		55	1,540	51 lbs.	120	113	103	1,872		
S-3860		48"		55	1,540	61 lbs.	172	158	150	2,244		
S-14335		60"		40	1,540	61 lbs.	120	113	104	2,808		
S-15209		72"		30	770	48 lbs.	116	107	101	1,685		
S-15210	2½ x 2½"	30"	.225	60	1,320	53 lbs.	119	112	102	1,463		
S-3220		36"		55	1,320	63 lbs.	140	132	120	1,756		
S-3221		40"		45	1,320	56 lbs.	122	116	106	1,951		
S-3222		48"		35	1,320	54 lbs.	119	112	103	2,341		
S-14336		60"		25	1,320	41 lbs.	103	98	89	2,926		
S-14337		72"		30	660	60 lbs.	128	121	115	1,756		
■S-14338		96"		330	660	1,003 lbs.	1/2 skid bulk shpd. \$1,270			2,341		
S-3526		3 x 3"		12"	.225	120	2,200	55 lbs.	107	102	94	1,213
S-3527				18"		60	2,200	40 lbs.	82	77	72	1,806
S-3225				24"		60	1,100	55 lbs.	107	102	94	1,193
S-1280	30"		55	1,100		67 lbs.	128	121	115	1,491		
S-21276	32"		55	1,100		71 lbs.	138	128	121	1,591		
S-791	36"		55	1,100		70 lbs.	150	142	133	1,790		
S-709	40"		45	1,100		71 lbs.	140	132	121	1,988		
S-3251	42"		40	1,100		68 lbs.	133	122	116	2,088		
S-792	48"		35	1,100		64 lbs.	133	122	116	2,386		
S-2280	60"		25	1,100		50 lbs.	116	112	103	2,982		
S-2281	72"	20	550	51 lbs.	112	103	95	1,790				
■S-13081	96"	275	550	810 lbs.	1/2 skid bulk shpd. \$1,288			2,386				

■ SHIPS VIA MOTOR FREIGHT

**PALLET CONES**

Prevent double-stacking of freight orders to reduce damage to shipments.

- Easily strap or tape to the top of the pallet.
- Ships flat, easy to store.



**NO STACK®**

\* English, Spanish and French

MODEL NO.	DESCRIPTION	COLOR	SIZE	QTY./BNDL.	PRICE/BUNDLE	
					1	3+
S-7252	English Only	White	8 x 8 x 10"	50	\$80	\$70
S-22361	English Only	Red				
S-12245*	Trilingual	Yellow	8 x 8 x 10"	50	85	75

**ULINE**

S-23526	English Only	White	8 x 8 x 10"	100	\$100	\$95
---------	--------------	-------	-------------	-----	-------	------



S-23526

# EDGE PROTECTORS

Avoid costly damage to products in shipment or in storage.

- Stabilizes strapped or stretch-wrapped loads.
- Provides additional support when double-stacking pallets in warehouse.
- Eliminates shifting loads. • Cut to size with radial saw or Cutter, page 312.

## LIGHT DUTY

MODEL NO.	SIZE		THICK-NESS	QTY./CTN.	BOARDS/SKID	APPROX. WT./CTN.	PRICE PER CARTON			SKID LOT
							1	5	10+	
S-3185	2 x 2"	6"	.120	800	11,760	59 lbs.	\$150	\$139	\$128	\$1,300
S-5468		12"		250	5,880	39 lbs.	107	102	94	1,302
S-15198		18"		140	5,880	31 lbs.	85	80	73	1,887
S-8481		24"		130	2,940	40 lbs.	112	103	95	1,178
S-2441		30"		125	2,940	52 lbs.	139	128	119	1,473
S-2442		36"		125	2,940	59 lbs.	162	154	143	1,633
S-15199		40"		100	2,940	50 lbs.	140	132	120	1,964
S-2443		48"		100	2,940	65 lbs.	\$139 per ctn. any qty.			2,133
S-8482		60"		50	2,940	39 lbs.	107	102	94	2,945
S-8483		72"		55	1,470	58 lbs.	142	133	121	1,775
■S-23648	96"	735	1,470	940 lbs.	1/2 skid bulk shpd. \$1,282			2,356		
S-15200	3 x 3"	24"	.120	90	2,100	50 lbs.	95	88	82	1,199
S-15201		30"		75	2,100	49 lbs.	101	94	84	1,498
S-3856		36"		80	2,100	58 lbs.	132	121	115	1,798
S-15202		40"		75	2,100	65 lbs.	133	122	116	1,997
S-3857		48"		60	2,100	62 lbs.	132	121	115	2,397
S-15203		60"		40	2,100	49 lbs.	103	98	89	2,996
S-13082		72"		40	1,050	62 lbs.	119	112	103	1,798
■S-13110		96"		525	1,050	1,050 lbs.	1/2 skid bulk shpd. \$1,305			2,397

## MEDIUM DUTY

MODEL NO.	SIZE		THICK-NESS	QTY./CTN.	BOARDS/SKID	APPROX. WT./CTN.	PRICE PER CARTON			SKID LOT
							1	5	10+	
S-21278	2 x 2"	12"	.160	240	4,480	48 lbs.	\$107	\$103	\$98	\$1,202
S-21279		18"		180	4,480	54 lbs.	132	122	119	1,803
S-5469		24"		160	2,240	66 lbs.	150	140	132	1,144
S-1277		30"		100	2,240	52 lbs.	119	112	103	1,430
S-781		36"		100	2,240	66 lbs.	\$115 per ctn. any qty.			1,712
S-747		40"		95	2,240	70 lbs.	150	140	132	1,905
S-3197		42"		85	2,240	62 lbs.	140	132	121	2,000
S-20948		44"		80	2,240	57 lbs.	138	125	119	2,095
S-782		48"		80	2,240	70 lbs.	\$128 per ctn. any qty.			2,287
S-1278		60"		60	2,240	62 lbs.	146	139	128	2,858
S-1279	72"	50	1,120	62 lbs.	143	137	124	1,718		
■S-14152	84"	560	1,120	788 lbs.	1/2 skid bulk shpd. \$1,107			2,001		
■S-3858	96"	560	1,120	988 lbs.	1/2 skid bulk shpd. \$1,248			2,287		
■S-5509	120"	560	1,120	1,232 lbs.	1/2 skid bulk shpd. \$1,535			2,859		
S-8484	2½ x 2½"	36"	.160	60	1,920	43 lbs.	102	95	85	1,875
S-15204		40"		70	1,920	57 lbs.	150	142	137	2,084
S-13111		48"		45	1,920	49 lbs.	120	113	103	2,500
S-2458	3 x 3"	6"	.160	400	6,400	66 lbs.	130	119	114	1,263
S-1716		12"		200	3,200	61 lbs.	133	122	116	1,263
S-3525		18"		135	3,200	65 lbs.	133	122	116	1,859
S-2459		24"		100	1,600	66 lbs.	133	122	116	1,195

■ SHIPS VIA MOTOR FREIGHT

Continued on page 314

SAVE UP TO 55% ON SKID QUANTITIES



ULINE offers the largest selection of stock edge protectors in the country.

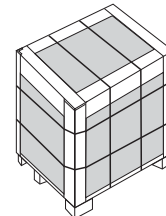

Palletizing

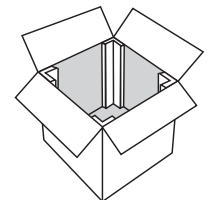

Added Internal Strength

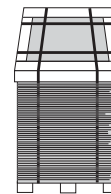

Protective

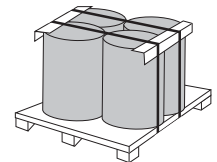

Roll Stack

Special sizes available.  
Call for a Quote.

1 skid minimum. 3 week lead time.







## KRAFT DUNNAGE BAGS

Stabilize valuable trailer, railcar and overseas shipments.

- Inflates in less than 2 minutes.
- Provides a safe, firm cushion up to 18" wide between skids.
- Strong kraft bags lined with poly.

2-PLY – Recommended for over the road shipments.

AAR APPROVED

MODEL NO.	SIZE	QTY./ CTN.	QTY./ SKID	PRICE PER CARTON				SKID LOT
				1	3	5	10+	
S-25157	24 x 36"	10	400	\$135	\$125	\$110	\$100	\$2,116
S-25158	36 x 36"		450	140	130	115	105	2,717
<b>S-24829</b>	<b>36 x 48"</b>		<b>350</b>	<b>\$110 per carton</b>				<b>2,252</b>
S-25159	36 x 66"		300	165	155	140	130	2,380
S-25160	36 x 84"		225	205	195	180	170	2,058
S-24831	48 x 48"		225	170	160	145	135	1,822
S-24832	48 x 60"		200	190	180	165	155	1,864
S-24833	48 x 84"		150	235	225	210	195	1,747
S-24830	48 x 96"		150	280	260	240	220	1,894

## INFLATOR GUNS

Requires compressed air supply.

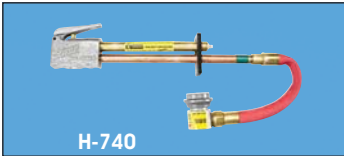

H-740



H-10095

H-10095	Use with 2-Ply Bags	\$50 each
H-740	Use with 4-Ply Bags	\$295 each

4-PLY – Recommended for overseas and rail shipments.

AAR APPROVED

MODEL NO.	SIZE	QTY./ CTN.	QTY./ SKID	PRICE PER CARTON				SKID LOT
				1	3	5	10+	
S-14349	36 x 48"	5	175	\$125	\$120	\$110	\$100	\$2,271
S-8015	36 x 66"		150	140	130	120	110	2,256
S-8016	36 x 84"		100	165	155	145	130	1,649
S-8017	48 x 48"		125	145	135	125	115	1,946
S-8018	48 x 84"		100	205	195	180	165	2,030
S-8019	48 x 96"		75	225	215	200	180	1,666

## INDUSTRIAL DUNNAGE BAGS



Use tough poly-woven bags when added strength is needed.

- Inflates in less than 1 minute.
- Stabilize your heaviest railcar shipments.
- Waterproof, chemical resistant, high burst strength.
- 12 mil bags. Reusable up to 10 times.

AAR APPROVED

MODEL NO.	SIZE	QTY./ CTN.	QTY./ SKID	PRICE PER CARTON			SKID LOT
				1	3	5+	
<b>S-14350</b>	<b>36 x 48"</b>	10	<b>450</b>	<b>\$94 per carton</b>			<b>\$2,342</b>
S-14351	36 x 66"		420	\$141	\$127	\$112	2,661
S-14352	36 x 84"		350	175	158	140	2,710
S-14353	48 x 48"		350	144	129	114	2,262
S-14354	48 x 84"		275	205	184	162	2,587
S-21251	48 x 96"		245	236	215	193	2,514

## VINYL DUNNAGE BAGS



Vinyl airbags ideal for bracing perishables, beverages and other odd-shaped loads.

- 9.8 mil bags can be reused up to 4 times.
- Convenient adhesive patches attach to shipment to prevent slippage.

MODEL NO.	SIZE	QTY./ CTN.	PRICE PER CARTON		
			1	3	5+
S-8010	36 x 48"	10	\$174	\$158	\$140
S-8011	36 x 66"		212	193	174
S-8012	36 x 84"		254	229	205
S-8013	48 x 48"		209	190	171
S-13079	48 x 84"		297	270	243



H-2056 Turbo



H-995

## INFLATOR GUNS

Inflate Industrial and Vinyl Dunnage Bags quickly and easily.

- H-2056 Turbo – Pressure gauge for precise filling. Worth the extra money.
- Inflator guns use air compressors.

MODEL NO.	DESCRIPTION	PRICE EACH
H-995	Inflator Gun	\$40
H-2056	Turbo Inflator Gun	99

# CHAIR MATS



**HARD SURFACE**

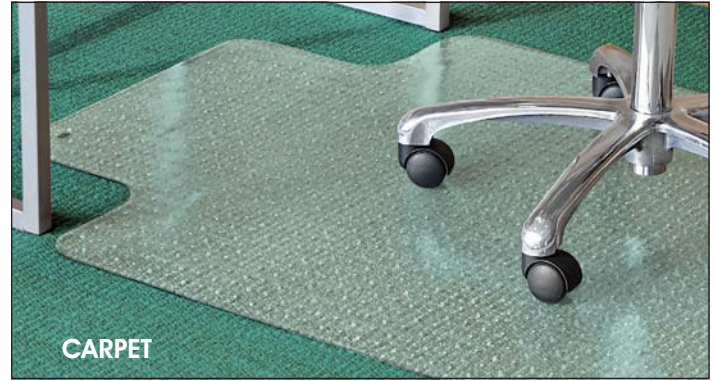

**CARPET**

Roll your chair effortlessly throughout your busy day.

- Anti-skid surface. Vinyl construction. Ships flat – No "roll-up."
- Workstation – For L-shaped desks.

## HARD SURFACE

- Flat textured backing grips firmly to hardwood, linoleum and tile.

## CARPET

- Cleated backing keeps mat firmly in place. Use on low pile carpeting.
- **Anti-Static Mats** – Prevent electrical shock damage. Cordless.
- **Plush** – For deep pile carpets over 3/4" thick including padding.

## BLACK

- Hide tired old carpeting.
- Available in 3 sizes.

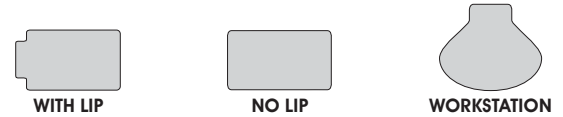

## CARPET

\* Black

MODEL NO.	SIZE	LIP SIZE W x L	PRICE EACH		
			1	3	6+
H-4522	36 x 36"	No Lip	\$47	\$45	\$43
<b>H-1460</b>	<b>36 x 48"</b>	<b>20 x 10"</b>	<b>\$45 each any quantity</b>		
H-6543*	36 x 48" Black	20 x 10"	84	81	78
H-2332	36 x 48"	No Lip	64	60	58
H-3366	36 x 48" Plush	20 x 10"	95	92	89
H-2333	36 x 48" Anti-Static	No Lip	77	72	69
■H-1461	45 x 53"	25 x 12"	56	54	50
■H-6544*	45 x 53" Black	25 x 12"	96	93	90
■H-2044	45 x 53"	No Lip	71	68	66
■H-2334	45 x 53" Anti-Static	No Lip	106	102	97
■H-2045	46 x 60"	25 x 12"	72	69	66
■H-6545*	46 x 60" Black	No Lip	119	114	111
■H-1694	46 x 60"	No Lip	77	72	69
■H-3368	46 x 60" Plush	No Lip	147	143	139
■H-4523	48 x 72"	No Lip	130	125	119
■H-2336	60 x 60"	No Lip	151	145	138
■H-2337	60 x 72"	No Lip	162	156	148
■H-3680	60 x 72" Plush	No Lip	242	232	223
■H-2338	60 x 96"	No Lip	216	209	196
■H-5342	66 x 60" Workstation	20 x 10"	120	114	108
■H-3681	72 x 72"	No Lip	180	171	163
■H-4524	72 x 96"	No Lip	228	218	209

■ SHIPS VIA MOTOR FREIGHT

■ SHIPS VIA MOTOR FREIGHT

## HARD SURFACE

MODEL NO.	SIZE	LIP SIZE W x L	PRICE EACH		
			1	3	6+
H-1691	36 x 48"	20 x 10"	\$52	\$50	\$47
H-2339	36 x 48"	No Lip	64	62	58
■H-1692	45 x 53"	25 x 12"	56	54	52
■H-2047	45 x 53"	No Lip	72	68	66
■H-2048	46 x 60"	25 x 12"	73	69	66
■H-1693	46 x 60"	No Lip	77	73	69
■H-3369	60 x 60"	No Lip	138	134	130
■H-3370	60 x 72"	No Lip	147	144	140
■H-3371	60 x 96"	No Lip	193	189	185
■H-4525	72 x 72"	No Lip	157	154	150

# NFL RUGS

For the ultimate fan – Your team front and center.

- Thick, plush 100% wool. • 3 x 5' rugs are hand tufted.

Specify team. Styles may vary. Imported.

MODEL NO.	SIZE	TEAM	PRICE EACH
S-11205	3 x 5'	All Teams Available	\$100

**FREE OFFER**  
Free upon request with any Uline order of \$1,500 or more.



# ANTI-FATIGUE MATS SOFT CUSHIONING



If you've ever worked at a packing table or on an assembly line, you know how tired your feet and legs get.

- Provides essential comfort. • PVC foam.
- Increases productivity.
- **5/8" EXTRA THICK** – 60% more cushioning.
- Custom sizes available, see [uline.com](http://uline.com)
- Anti-Static Mats, see page 755.

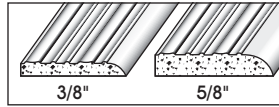

SPECIFY COLOR

## STANDARD SIZE – 3/8" THICKNESS

MODEL NO.	SIZE	THICKNESS	PRICE EACH		
			1	3	6+
H-65	3 x 4'	1/4"	\$36	\$34	\$29
H-651	2 x 3'	3/8"	21	20	19
H-2372	2 x 4'		28	27	26
H-712	2 x 6'		39	36	34
H-66	27" x 5'		36	34	32
H-646	2 x 8'		50	47	43
H-647	2 x 10'	3/8"	64	57	53
H-2021	2 x 12'		75	70	63
H-713	2 x 16'		97	90	82
H-735	2 x 20'		124	115	103
H-736	3 x 3'		29	28	26
H-1715	3 x 4'	3/8"	39	36	34
H-274	3 x 5'		47	44	42
H-688	3 x 6'		56	53	48
H-648	3 x 8'		74	69	62
H-737	3 x 9'		83	77	70
H-649	3 x 10'	3/8"	92	87	78
H-314	3 x 12'		113	105	94
H-714	3 x 15'		137	126	116
H-2022	3 x 20'		179	170	160
H-3100	3 x 25'		221	209	198
H-715	4 x 4'	3/8"	50	47	43
H-650	4 x 6'		74	69	62
H-1716	4 x 8'		97	90	82
H-783	4 x 10'		123	113	102
H-784	4 x 12'		146	135	123
H-785	4 x 16'	3/8"	195	180	164
H-2023	5 x 5'		80	74	69

## FULL-LENGTH ROLLS – 3/8" THICKNESS

MODEL NO.	SIZE	THICKNESS	WEIGHT (LBS.)	PRICE EACH	
				1	2+
H-3106	3 x 30'	3/8"	48	\$223	\$214
H-10	2 x 60'	3/8"	63	271	259
H-11	3 x 60'		100	410	390
H-12	4 x 60'	3/8"	118	528	503
H-2374	6 x 60'		217	818	780

SHIPS VIA MOTOR FREIGHT

## STANDARD SIZE – 5/8" THICKNESS

MODEL NO.	SIZE	THICKNESS	PRICE EACH		
			1	3	6+
H-5885*	2 x 2'	5/8"	\$21	\$20	\$19
H-881	2 x 3'		30	29	28
H-3101*	2 x 4'		40	39	36
H-1309	2 x 6'		60	57	55
H-2024	2 x 8'		82	78	76
H-3102*	2 x 10'	5/8"	102	97	94
H-5886*	2 x 12'		122	117	113
H-9339*	2 x 16'		158	151	143
H-5887*	2 x 20'		194	183	171
H-9340*	3 x 3'		47	44	42
H-1717	3 x 4'	5/8"	60	57	55
H-882	3 x 5'		73	70	68
H-1718	3 x 6'		89	85	82
H-1719	3 x 8'		119	115	110
H-1720*	3 x 10'		146	139	133
H-1310	3 x 12'	5/8"	174	167	160
H-1721	3 x 15'		218	209	201
H-9341*	3 x 16'		234	222	211
H-3103*	3 x 18'		261	252	242
H-3104*	3 x 20'		291	281	269
H-9342*	4 x 4'	5/8"	82	80	76
H-883	4 x 6'		119	115	110
H-2373*	4 x 8'		159	153	147
H-9343*	4 x 10'		205	193	181
H-2025*	4 x 12'		240	230	220
H-2026*	4 x 16'	5/8"	317	304	291
■H-3105*	4 x 20'		397	381	365

\* Black only

■ SHIPS VIA MOTOR FREIGHT

## FULL-LENGTH ROLLS – 5/8" THICKNESS

MODEL NO.	SIZE	THICKNESS	WEIGHT (LBS.)	PRICE EACH	
				1	2+
H-1722*	2 x 30'	5/8"	52	\$247	\$234
H-1723	3 x 30'		80	369	349
H-1724*	4 x 30'		108	490	466
H-5888*	3 x 40'	5/8"	106	488	468
H-5889*	4 x 40'		140	651	626
H-5890*	3 x 60'	5/8"	176	732	713

\* Black only

SHIPS VIA MOTOR FREIGHT



# CADILLAC MATS

**SOFT CUSHIONING**

**STANDARD SIZE**

\*Also available in Black/Yellow

MODEL NO.	SIZE	THICKNESS	PRICE EACH		
			1	3	6+
H-34*	2 x 3'	3/8"	\$29	\$26	\$24
H-640	2 x 4'		37	35	31
H-786	2 x 5'		47	44	38
H-261	2 x 6'		55	52	47
H-641	2 x 8'		74	70	61
H-689	2 x 10'		92	86	78
H-690	2 x 12'	3/8"	112	103	92
H-1677	2 x 16'		149	136	124
H-2363	2 x 20'		185	170	155
H-787	3 x 3'		43	38	35
H-262	3 x 4'	3/8"	55	52	47
H-51*	3 x 5'		70	64	58
H-263	3 x 6'		83	77	70
H-788	3 x 7'		97	88	80
H-642*	3 x 8'		112	103	92
H-53	3 x 10'		138	128	116
H-643*	3 x 12'	3/8"	166	152	138
H-691	3 x 16'		220	204	184
H-2364	3 x 20'		275	254	229
H-789	4 x 4'		74	70	61
H-3087	4 x 5'	3/8"	92	86	78
H-52	4 x 6'		112	103	92
H-264	4 x 8'		149	136	124
H-657	4 x 10'		185	170	155
H-658	4 x 12'		220	204	184
H-2010	4 x 16'		295	269	245
H-2365	4 x 20'	3/8"	368	336	305
H-1678	5 x 8'		185	170	155
H-2366	5 x 10'		230	211	196
H-3088	6 x 6'		166	152	138
H-2011*	2 x 3'	5/8"	41	38	36
H-3089	2 x 4'		53	50	47
H-9361	2 x 5'		66	64	58
H-3090	2 x 6'		76	71	66
H-3091	2 x 8'		108	100	92
H-3092	2 x 10'		133	126	118
H-3093	2 x 12'	5/8"	150	142	131
H-9362	2 x 16'		210	198	186
H-5891	2 x 20'		265	253	241
H-3094	3 x 4'		76	71	66
H-2012*	3 x 5'	5/8"	92	88	82
H-2367	3 x 6'		112	104	97
H-2013*	3 x 8'		150	142	131
H-3095	3 x 10'		187	178	164

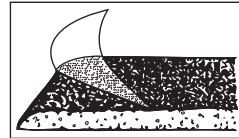

This is the "Cadillac" of mats, the one used in Uline warehouses.

- Smoother surface, unlike ribbed mats, allows for **easy turns and quick pivoting all day long.**
- Beveled edges help keep warehouses safe – No tripping.
- Dyna-Shield® PVC cleans easily and lasts longer.
- **5/8" thick** – 60% more cushioning.
- Custom sizes available, see [uline.com](http://uline.com)

**STANDARD SIZE**

MODEL NO.	SIZE	THICKNESS	PRICE EACH		
			1	3	6+
H-2014*	3 x 12'	5/8"	\$223	\$212	\$198
H-5138	3 x 16'		300	284	264
H-5892	3 x 18'		336	320	296
H-5893	3 x 20'		374	358	331
H-9363	4 x 4'	102	96	90	
H-2368	4 x 6'	5/8"	150	142	131
H-3096	4 x 8'		200	190	176
H-9364	4 x 10'		252	238	222
H-3097	4 x 12'		300	284	264
H-9365	4 x 16'		408	382	354
■H-5894	4 x 20'		499	474	440
■H-9366	4 x 25'	5/8"	672	642	612
H-5895	5 x 8'		248	239	220
H-5896	6 x 8'		298	284	264

■ SHIPS VIA MOTOR FREIGHT

**FULL-LENGTH ROLLS**

SHIPS VIA MOTOR FREIGHT

MODEL NO.	SIZE	THICKNESS	WEIGHT (LBS.)	PRICE EACH	
				1	2+
H-790	2 x 60'	3/8"	69	\$432	\$408
H-81	3 x 60'		96	666	642
H-1315	4 x 60'		143	864	834
H-2369	2 x 30'	5/8"	56	414	396
H-2370	3 x 30'		83	624	600
H-2371	4 x 30'		110	834	804





## HOG HEAVEN™ NITRILE MATS

Unique soft top anti-fatigue mat provides exceptional comfort.

- Use in computer rooms, warehouses and assembly lines.
- Slip-resistant nitrile resists grease and oil.
- Anti-static. Welding safe.

\*Also available in Solid Black

MODEL NO.	SIZE	THICKNESS	PRICE EACH		
			1	3	6+
H-2007*	2 x 3'	5/8"	\$72	\$69	\$66
H-9367	2 x 6'		145	142	137
H-9368	2 x 8'		194	191	186
H-5140	3 x 4'	5/8"	120	118	114
H-2008*	3 x 5'		154	149	144
H-9369	3 x 6'		198	195	189
H-4486*	3 x 8'		264	256	248
H-8039	3 x 10'		330	322	312
H-2009	3 x 12'		374	364	351
■H-9370	3 x 20'		660	635	609
H-3113	4 x 6'	5/8"	247	242	233
H-5141	4 x 12'		480	462	442
H-5142	4 x 16'		640	617	592
H-5143	5 x 8'		454	434	412

■ SHIPS VIA MOTOR FREIGHT

MODEL NO.	SIZE	THICKNESS	PRICE EACH		
			1	3	6+
H-3114*	2 x 3'	7/8"	\$79	\$77	\$74
H-9371	2 x 6'		165	162	157
H-9372	2 x 8'		220	217	212
H-5144	3 x 4'	7/8"	136	133	127
H-3115*	3 x 5'		176	173	166
H-9373	3 x 6'		224	220	215
H-4487*	3 x 8'		299	290	280
H-8040	3 x 10'		374	366	356
H-3116	3 x 12'		418	407	392
■H-9374	3 x 20'		748	720	695
H-3117	4 x 6'	7/8"	275	269	260
H-5145	4 x 12'		540	522	497
H-5146	4 x 16'		720	692	662
H-5147	5 x 8'		507	487	465

■ SHIPS VIA MOTOR FREIGHT

## DIAMOND TREAD MATS

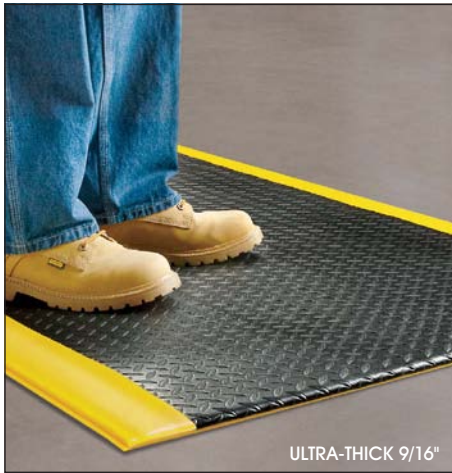

ULTRA-THICK 9/16"

Ultra-thick 9/16" cushy foam base – like walking on air.

- Use at service counters and workstations. Anti-fatigue comfort.
- High-density vinyl coating.
- Beveled edges reduce tripping.
- Diamond plate traction.

**Full-Length Roll** – Extra-long runner for manufacturing, production lines.

MODEL NO.	SIZE	THICKNESS	PRICE EACH		
			1	3	6+
H-2479	2 x 3'	9/16"	\$41	\$39	\$37
H-9375	2 x 10'		133	128	122
H-3624	3 x 4'		76	72	69
H-2480	3 x 5'		96	92	89
H-3625	3 x 6'		116	112	109
H-2481	3 x 12'		227	221	213
H-9376	3 x 16'		295	290	284

**FULL-LENGTH ROLL**

SHIPS VIA MOTOR FREIGHT

MODEL NO.	SIZE	THICKNESS	WT. (LBS.)	PRICE EACH	
				1	2+
H-9377	3 x 75'	9/16"	176	\$1,331	\$1,302

## REJUVENATOR® MATS



CRUSH RESISTANT

The last mat you will ever have to buy. Hurts your checkbook, but energizes your feet.

- Use in the busiest environments like mailrooms and shipping stations.
- Virtually indestructible. Heels and chairs will not dent this mat.
- Highly resistant urethane.
- 3 year warranty.

MODEL NO.	SIZE	THICKNESS	PRICE EACH		
			1	3	6+
H-2354	2 x 3'	5/8"	\$140	\$135	\$130
H-9378	2 x 5'		225	220	215
H-2355	3 x 5'		270	265	255

# MARBLE MATS

**FIRM CUSHIONING**

MODEL NO.	SIZE	THICKNESS	PRICE EACH		
			1	3	6+
H-330	18 x 30"	1/2"	\$46	\$43	\$40
H-331	2 x 3'	1/2"	70	66	61
H-716	2 x 4'		93	89	82
H-3167	2 x 5'		115	110	100
H-781	2 x 6'		135	130	120
H-717	2 x 8'		185	175	160
H-332	2 x 10'		230	215	200
H-1687	2 x 12'		275	260	240
H-1688	3 x 4'		1/2"	140	135
H-333	3 x 5'	170		160	150
H-718	3 x 6'	210		195	180
H-719	3 x 8'	275		260	240
H-334	3 x 10'	350		325	300
H-3168	3 x 12'	415		385	360
H-335	3 x 15'	510		480	440
H-892	4 x 6'	275		260	240
H-3169	4 x 8'	365		345	320
H-1689	2 x 3'	1"		104	100
H-9411	2 x 6'		194	184	173
H-1690	3 x 5'		230	219	208
H-9412	3 x 8'		373	355	336
H-2358	3 x 10'		450	427	406
H-2359	3 x 15'		675	643	610
H-3170	4 x 6'		373	355	337

■ SHIPS VIA MOTOR FREIGHT



SPECIFY COLOR:

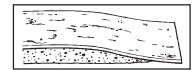

Beveled Edge for Increased Safety

Long life anti-fatigue matting. Easy to sweep, clean and maintain.

- Durable mat includes a marbled vinyl tile surface and sponge base.
- Beveled edges.
- Custom sizes available, see [uline.com](http://uline.com)

# DIAMOND PLATE MATS

\*Also available in Solid Black

MODEL NO.	SIZE	THICKNESS	PRICE EACH		
			1	3	6+
H-899*	2 x 3'	9/16"	\$57	\$55	\$52
H-1695	2 x 6'		115	110	105
H-1298*	2 x 8'		150	145	140
H-3171*	2 x 10'		190	180	175
H-3172*	3 x 4'	9/16"	125	120	115
H-900*	3 x 5'		145	140	135
H-1299*	3 x 6'		170	165	155
H-1176*	3 x 8'		220	215	205
H-1696	3 x 10'		275	265	255
H-901*	3 x 12'		320	310	300
H-1177	3 x 16'		405	390	370
H-902	4 x 6'		9/16"	220	215
H-1178	4 x 8'	295		285	275
H-1179	4 x 12'	405		390	370
H-1697	2 x 3'	15/16"	87	84	79
H-1698*	3 x 5'		215	205	195
H-2356	3 x 6'		255	240	230
H-1699	3 x 8'		335	320	300
H-2357	3 x 10'		420	400	380
H-1700	3 x 12'		475	450	425

FULL-LENGTH ROLLS

SHIPS VIA MOTOR FREIGHT

MODEL NO.	SIZE	THICKNESS	WT. (LBS.)	PRICE EACH	
				1	2+
H-9413	2 x 75'	9/16"	152	\$1,129	\$1,019
H-9414	3 x 75'			1,491	1,349

**SOFT CUSHIONING**



Combine ultra-soft cushioning with anti-slip treads.

- Recommended for dry work areas: packing stations, machine shops and receiving areas.
- Tough vinyl diamond plate surface bonded to dense foam base. Beveled edges.

15/16" thick – Stand longer with less muscle strain.

Full-Length Rolls – Long, continuous matting for production and assembly lines.



## SCRAPER ENTRY MATS



Maximum traction mat ensures safe footing. Low profile.

- Scrapes shoes clean to avoid tracking in mud, slush and grime.
- Durable rubber compound stands up to harsh weather conditions.
- Easy to clean – Simply hose off.

MODEL NO.	SIZE	THICKNESS	PRICE EACH		
			1	3	6+
H-3591	2½ x 3'	3/16"	\$41	\$39	\$36
H-1680	3 x 5'		80	76	73
H-1681	3 x 10'		152	144	136
H-1682	4 x 6'		122	117	110
H-1701	4 x 8'		160	152	144

## RUBBERIZED ENTRY MATS



Hundreds of tough, flexible rubber fingers sweep shoes clean of snow, grit and dirt.

- Debris stays trapped below walking surface.
- The perfect all-weather mat. Stays flexible in sub-zero temperatures.
- No-trip beveled edges.

MODEL NO.	SIZE	THICKNESS	PRICE EACH		
			1	3	6+
H-1711	2 x 2½'	5/8"	\$42	\$41	\$38
H-1330	2½ x 3½'		67	64	60
H-1712	3 x 5'		133	126	118
H-1331	3 x 6'		140	134	127

## HOG HEAVEN™ MODULAR MAT



Stops you dead in your tracks!

- Raised rubber squares provide optimum traction.
- Create your own configuration with interlocking tiles.
- Resists grease, oil and chemicals.
- Anti-static.



MODEL NO.	TYPE	SIZE	THICKNESS	PRICE EACH		
				1	3	6+
H-9585	Middle	18 x 18"	3/4"	\$44	\$42	\$40
H-9586	Side			60	58	56
H-9587	Corner			71	69	67

## MODULAR DRAINAGE MATS



Custom-fit your mat around any workstation or production machine.

- Strong interlocking system securely connects tiles.
- Ideal in dirty or slippery areas.
- 100% rubber for comfort. Reduces fatigue.
- Optional beveled edges for easy access on and off mat.



MODEL NO.	TYPE	SIZE	THICKNESS	PRICE EACH		
				1	3	6+
H-2341	Drainage Solid	3' x 3'	3/4"	\$63	\$61	\$59
H-2342				68	66	64
H-2343	Male Edge	2' x 40"		20	19	18
H-2344	Female Edge					

# DRAINAGE MATS



## SLIP GUARD

CAFETERIAS

Recommended for beverage stations, washrooms, cafeterias.

- 100% nitrile rubber. Superior slip resistance.
- 5/8" drainage holes for easy flow of liquid and debris.
- Anti-microbial treated. Helps resist odors.
- Unique criss-cross pattern provides traction.

MODEL NO.	SIZE	THICKNESS	WT. (LBS.)	PRICE EACH		
				1	3	6+
H-1180	2 x 3'	7/16"	6	\$55	\$53	\$51
H-1181	3 x 5'		14	110	106	102
H-1182	3 x 9'		26	220	212	204
H-1183	4 x 6'		19	176	171	163



## SLIP RESISTANT

BARS AND KITCHENS

Recommended for kitchens, bars and machine shops.

- Heavy-duty rubber. • Mat resists grease.
- Debris falls through holes. Hose off quickly to clean.

**Terra Cotta** – Grease-proof nitrile mats withstand harsh grease and chemicals.

■ SHIPS VIA MOTOR FREIGHT

MODEL NO.	TYPE	SIZE	THICKNESS	WT. (LBS.)	PRICE EACH		
					1	3	6+
H-1703	Black Slip-resistant	3 x 5'	1/2"	26	\$79	\$75	\$73
H-1704		3 x 10'		53	155	147	143
■H-6027		3 x 20'		106	330	318	306
H-1705	Terra Cotta Grease-proof	3 x 5'	1/2"	27	98	95	92
H-1706		3 x 10'		56	195	186	181
■H-9395		3 x 20'		110	486	477	465



## SAFETY MATS

WAREHOUSES

Used in machine shops, warehouses and assembly lines.

- High grade rubber. Works well on wet or dry surfaces.
- Sturdy, cushioned anti-fatigue mat provides exceptional grip and drainage.
- 3-sided beveled yellow borders meet OSHA code.

■ SHIPS VIA MOTOR FREIGHT

MODEL NO.	SIZE	THICKNESS	WT. (LBS.)	PRICE EACH		
				1	3	6+
H-1325	2 x 3'	7/8"	21	\$95	\$92	\$89
H-1702	3 x 3'		30	157	151	145
H-1326	3 x 5'		45	175	168	161
■H-1327	3 x 10'		88	335	325	314



## SUPERFOAM™ MATS

EASY TO CLEAN

Highly recommended for work areas that require frequent cleaning.

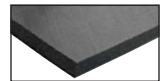

- Ultra lightweight. Easy to lift, easy to maintain.
- Nonabsorbent. Resists spills, motor oil and grease.

**Solid** – For assembly lines and service counters.

**Drainage Holes** – For food prep and dishwashing stations.

MODEL NO.	TYPE	SIZE	THICKNESS	WT. (LBS.)	PRICE EACH		
					1	3	6+
H-5131	Solid	3 x 5'	5/8"	17	\$208	\$200	\$192
H-5132		4 x 6'		27	330	317	305
H-5133	Drainage	3 x 5'	5/8"	16	228	220	211
H-5134		4 x 6'		26	358	346	338



# CARPET MATS



MODEL NO.	SIZE	THICKNESS	PRICE EACH		
			1	3	6+
H-644	2 x 3'	5/16"	\$27	\$26	\$25
H-112	3 x 4'		54	52	50
H-113	3 x 5'		67	65	62
H-645	3 x 6'		81	78	75
H-485	3 x 8'	5/16"	108	104	99
H-486	3 x 10'		132	127	122
H-487	3 x 12'		162	157	152
H-884	3 x 16'		217	207	202
H-1982	3 x 20'		272	252	237
H-114	4 x 6'	5/16"	108	104	99
H-659	4 x 8'		157	147	137
H-679	4 x 10'		177	167	162
H-2352	4 x 20'		372	352	332

- Plush 5/16" pile Olefin carpet gobbles up dirt and water and is easy on your feet.
- Vacuum, sweep or hose down to clean.

## STANDARD

Stop tracking warehouse dust, dirt and grime into office areas.



## RUNNERS

High traffic floor protection for long hallways.

- Use everywhere – schools, churches, businesses, shopping malls and hospitals.

SHIPS VIA MOTOR FREIGHT

MODEL NO.	SIZE	THICKNESS	PRICE EACH		
			1	3	6+
H-1707	3 x 30'	5/16"	\$410	\$390	\$370
H-1277	3 x 60'		800	765	735
H-1708	4 x 30'	5/16"	555	530	505
H-1278	4 x 60'		1,090	1,040	990



SPECIFY COLOR: Black, Gray, Brown, Burgundy or Blue

MODEL NO.	SIZE	THICKNESS	PRICE EACH		
			1	3	6+
H-1279	2 x 3'	5/16"	\$30	\$29	\$28
H-7194	2 x 6'		57	55	53
H-1709	2 x 8'		77	74	71
H-680	3 x 4'		57	55	53
H-681	3 x 5'		71	69	65
H-682	3 x 6'	5/16"	84	81	78
H-1710	3 x 8'		112	107	102
H-683	3 x 10'		137	132	127
H-885	3 x 12'		167	162	157
H-1983	3 x 16'		222	212	202
H-684	4 x 6'	5/16"	112	107	102
H-1280	4 x 8'		157	152	142
H-886	4 x 12'		222	212	202
H-2351	6 x 8'		222	212	202

## DELUXE

60% longer lasting than standard carpet mats.

- Dense 5/16" polypropylene loop-pile fibers.
- Won't fray and resists crushing.
- Vinyl/nitrile backing is non-marking and non-staining.

# CUSTOM CARPET MATS

PRICE INCLUDES 1 MAT COLOR AND UP TO 3 LOGO COLORS. SEE ALL 28 COLORS ON ULINE.COM

Create a positive first impression of your company.

- Long-lasting crushproof twisted polyester with rubber backing.
- Send camera-ready artwork. Ships 1 week after proof approval.

MODEL NO.	SIZE	WT. (LBS.)	PRICE EACH		
			1	2	3+
S-8605	3 x 4'	8	\$154	\$149	\$138
S-8499	3 x 5'	10	187	182	171
S-13168	3 x 10'	25	358	341	325
S-8606	4 x 6'	15	281	270	253





# WATERHOG™

SPECIFY COLOR: Charcoal, Red/Black, Medium Gray, Green, Brown or Navy

MODEL NO.	SIZE	THICKNESS	PRICE EACH		
			1	3	6+
H-1994	18 x 27"	3/8"	\$26	\$24	\$22
H-625	2 x 3'		37	33	30
H-7186	2 x 6'		75	70	66
H-7187	3 x 3'		56	53	49
H-626	3 x 4'		72	68	64
H-627	3 x 5'		89	84	78
H-3140	3 x 6'	3/8"	108	102	95
H-1995	3 x 8'		158	150	141
H-694	3 x 10'		175	165	154
H-1683	3 x 12'		235	221	207
H-1996	3 x 16'		315	298	280
H-2353	4 x 4'		96	93	90
H-3141	4 x 5'	3/8"	120	117	114
H-628	4 x 6'		140	134	129
H-1282	4 x 8'		210	200	190
H-629	4 x 10'		230	219	209
H-1684	4 x 12'		315	293	271
H-1998	4 x 16'		420	404	389
H-3142	6 x 6'	3/8"	222	206	191
H-1283	6 x 8'		315	293	271
H-3143	6 x 10'		370	344	317
H-2000	6 x 12'		471	413	380
■H-2001	6 x 16'		630	588	546



Soak up snow, water and ice quickly. End wet, slippery floors.

- Solid rubber nubs prevent carpet from crushing.
- Nonslip rubber backing.
- Tough PET polyester fiber system.
- Custom inlay Waterhog™ Mats, see [uline.com](http://uline.com)

## RUNNERS

MODEL NO.	SIZE	THICKNESS	PRICE EACH		
			1	3	6+
H-1997	3 x 20'	3/8"	\$395	\$373	\$350
H-1999	4 x 20'		525	504	483
■H-2002	6 x 20'		785	730	675

■ SHIPS VIA MOTOR FREIGHT

## RUNNERS

High traffic floor protection for long hallways.

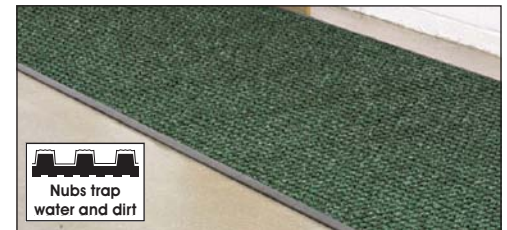

# WATERHOG™ ELITE

Waterhog™ Mat on steroids!

- Upscale fabric edge with rubber reinforced pattern.
- Traps dirt and water.
- Non-skid rubber backing. Tough PET polyester fiber.

SPECIFY COLOR: Charcoal, Burgundy or Brown

MODEL NO.	SIZE	THICKNESS	PRICE EACH		
			1	3	6+
H-6528	2 x 3'	3/8"	\$41	\$39	\$37
H-3646	3 x 4'		83	79	75
H-3151	3 x 5'		103	99	95
H-3152	3 x 10'		203	193	184
H-3153	4 x 6'		164	156	148
H-6529	4 x 8'		250	240	230
H-6530	4 x 10'		295	285	275
H-3647	6 x 8'		390	380	370



# WATERHOG™ PREMIER



Beautiful diamond pattern that's tough as nails.

- 25% thicker fabric for heavy traffic areas.
- Upscale fabric edge with rubber reinforced pattern.
- Non-skid rubber backing. Tough polyester fiber.

SPECIFY COLOR: CHARCOAL BURGUNDY BROWN

MODEL NO.	SIZE	THICKNESS	PRICE EACH		
			1	3	6+
H-4513	3 x 5'	3/8"	\$103	\$99	\$95
H-4514	3 x 10'		203	193	184
H-4515	4 x 6'		164	156	148

# WATERHOG™ DIAMONDCORD



Multicolored berber adds a vibrant look.

- Corduroy grooves hide dirt and debris.
- Rubber edge and reinforced pattern.
- Non-skid rubber backing. Tough polypropylene fiber.

SPECIFY COLOR: CHARCOAL BROWN

MODEL NO.	SIZE	THICKNESS	PRICE EACH		
			1	3	6+
H-4518	3 x 5'	3/8"	\$110	\$105	\$100
H-4519	3 x 10'		215	205	195
H-4520	4 x 6'		170	165	155

# PLUSH NYLON MATS



Long-lasting nylon is super resilient. Won't crush and fade under heavy use in lobbies and theaters.

- Plush carpet cleans easily with carpet sweepers. Washable, too.
- Rubber cleats on the bottom prevent slippage.
- Durable rubber backing.

SPECIFY COLOR: BROWN BLACK CHARCOAL NAVY

MODEL NO.	SIZE	THICKNESS	PRICE EACH		
			1	3	6+
H-4510	3 x 5'	3/8"	\$135	\$125	\$115
H-4511	3 x 10'		250	235	220
H-4512	4 x 6'		195	185	175

# AQUA-LOCK MICROFIBER MATS



Soak up Seattle rain and Colorado snow. Super absorbent.

- Microfiber miracle fabric traps 2.5 times more water than standard carpet mats.
- Heather pattern hides stains, dirt and dust.
- Nitrile rubber backing.

SPECIFY COLOR: BLACK CHARCOAL/BLACK BROWN/BLACK

MODEL NO.	SIZE	THICKNESS	PRICE EACH		
			1	3	6+
H-9396	3 x 5'	7/16"	\$135	\$125	\$115
H-9397	3 x 10'		250	235	220
H-9398	4 x 6'		195	185	175



# WATERHOG™ BOOT TRAYS

Check your muddy boots at the door.

- Cleated rubber backing prevents slippage.
- Heavy duty PET polyester fabric with raised border.

SPECIFY COLOR: CHARCOAL NAVY BROWN

MODEL NO.	SIZE	THICKNESS	WT. (LBS.)	PRICE EACH		
				1	3	6+
H-7200	15 x 36"	1/2"	4	\$38	\$35	\$32
H-7201	15 x 48"		6	49	46	42



# MUD MASTER

SPECIFY COLOR: Charcoal, Green, Red or Brown

MODEL NO.	SIZE	THICKNESS	PRICE EACH		
			1	3	6+
H-887	2 x 3'	3/8"	\$33	\$30	\$29
H-888	3 x 4'		66	60	58
H-1281	3 x 5'		78	74	70
H-889	3 x 6'		95	90	83
H-2348	3 x 8'		130	119	110
H-890	3 x 10'	3/8"	157	147	138
H-1685	3 x 12'		190	178	168
H-3372	3 x 16'		245	232	223
H-3651	3 x 20'		308	293	280
H-891	4 x 6'		126	120	110
H-1686	4 x 8'		169	158	150
H-2349	4 x 10'		201	191	180
H-2003	6 x 8'		251	235	223
H-2350	6 x 10'		308	293	280



Quickly scrape mud and dirt from your shoes.

- Ridges in Olefin carpet bury dirt below the surface.
- Ideal for entryways and lobbies.



# RIBBED ENTRY MATS

SPECIFY COLOR: CHARCOAL BROWN BURGUNDY

MODEL NO.	SIZE	THICKNESS	PRICE EACH		
			1	3	6+
H-5136	3 x 4'	3/8"	\$96	\$91	\$87
H-3110	3 x 5'		122	118	113
H-3111	3 x 10'		240	231	221
H-3112	4 x 6'		191	185	178
H-5137	4 x 8'		255	249	243



Upscale, fashionable indoor mat for main entrances.

- Use in country clubs, resorts and casinos.
- Nonslip rubber backing. Won't curl.
- Carpeted no-trip beveled edges.

# TURF ENTRY MATS

SPECIFY COLOR: BURGUNDY CHARCOAL NAVY

MODEL NO.	SIZE	THICKNESS	PRICE EACH		
			1	3	6+
H-1984	3 x 5'	3/8"	\$124	\$120	\$116
H-3592	3 x 8'		198	192	185
H-1985	3 x 10'		246	237	229
H-1986	4 x 6'		196	190	184
H-3593	4 x 8'		263	254	246
H-1987	4 x 10'		322	312	301
H-7188	6 x 8'		407	397	386



Tough turf fibers clean dirt, grit and moisture from shoes.

- For golf club lobbies, restaurant patios and lodges.
- Rubber backing won't crack or curl.
- Colors resist fading in sunlight. Slip resistant.

# 3M NOMAD™ SCRAPER MATS

Spaghetti-style scraper mat traps dust and dirt.

- Use in hotel, school and restaurant lobbies.

3M 6050

SPECIFY COLOR: BLACK GRAY

MODEL NO.	SIZE	THICKNESS	PRICE EACH		
			1	3	6+
H-7939	3 x 5'	3/8"	\$180	\$175	\$170
H-7940	4 x 6'		265	260	255



- Cushioned vinyl foam backing protects floors.
- Shake, vacuum or hose down to clean.



# STAIR TREADS



**Vinyl** – Oil and chemical resistant. Ribbed pattern.

**Rubber** – Heavy duty, commercial grade. Coin pattern.

**Landing Tiles** – Use with Rubber Stair Treads. Cut to size with Uline H-64 knife.

Stair Tread Risers available, see [uline.com](http://uline.com)

Protect against slips, falls and wear. Spruce up old stairs instantly.

- Fits square-nosed wood, concrete or steel stairs.
- Install with adhesive, sold separately.



Vinyl



Rubber

**STAIR TREADS** SPECIFY COLOR:  Black  Gray  Brown

MODEL NO.	DESCRIPTION	SIZE W x D	THICKNESS	PRICE EACH	
				1	5+
H-5880	Vinyl	36 x 12"	1/4"	\$39	\$35
H-3653		48 x 12"		50	46
H-3654		72 x 12"		74	69
H-5881	Rubber	36 x 12"	3/16"	65	62
H-3655		48 x 12"		86	83
H-3656		72 x 12"		120	114
S-19034	Adhesive – 1 Gallon			56	53

**LANDING TILES** SPECIFY COLOR:  Black  Gray

MODEL NO.	DESCRIPTION	SIZE W x D	THICKNESS	PRICE EACH	
				1	5+
H-7933	Rubber	18 x 18"	1/8"	\$32	\$30

# CASHIER MATS



Extra thick, cushy mats provide all-day comfort for your feet.

- Recommended for retail counters and heavy traffic areas.

- One piece, tear-resistant polyurethane construction.
- No-trip beveled edges. Nonslip top and bottom.

MODEL NO.	SIZE	THICKNESS	PRICE EACH		
			1	3	6+
H-5159	2 x 3'	3/4"	\$88	\$85	\$82
H-5940	2 x 4'		120	116	111
H-5160	3 x 5'		223	216	210
H-8044	4 x 6'		357	347	336

# SANITIZING FOOTBATH MATS



Bathe boots and shoes to prevent the spread of germs and bacteria.

- Recommended for food processing facilities, labs or greenhouses.

- Flexible rubber scrapers remove debris from boots and shoes.



MODEL NO.	DESCRIPTION	SIZE	CAPACITY (GAL.)	WALL HEIGHT	PRICE EACH	
					1	3+
H-9386	Black Wall	24 x 32"	1	1/2"	\$73	\$68
H-9387	Yellow Wall				93	88
H-5241	Black Wall	32 x 39"	5 1/2	2 1/2"	155	150
H-6565	Yellow Wall				195	190



CUSHY AND COMFORTABLE

# ERGODECK® MATS

More information, see [uline.com](http://uline.com)

Modular flooring can be custom-fit around machines.

- Patented interlocking system keeps beefy 7/8" tiles connected.
- 100% PVC resists oil and chemicals.
- Easy on, easy off ramps for carts and pallet jacks.

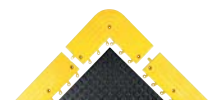

MODEL NO.	DESCRIPTION	SIZE W x L	THICKNESS	QTY./ CTN.	PRICE PER CARTON			
					1	3	6+	
H-9388	Drainage Tile	18 x 18"	7/8"	10	\$325	\$315	\$305	
H-9389	Solid Tile							
H-9390	6" Strip	6 x 18"	7/8"	10	200	195	190	
H-9391	Ramp Edge	6 x 18"			4	135	130	125
H-9392	Ramp Corner	6 x 15"				190	185	180

# FOAM FLOOR TILES

Quickly create soft, flexible flooring.

- Use in day cares, gyms and trade shows.
- Interlocking tiles assemble in minutes.
- Lightweight, durable EVA foam. Waterproof.

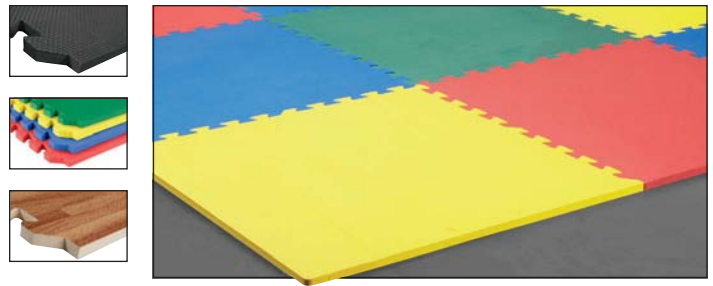

\* Color Pack: Red, Yellow, Green and Blue

MODEL NO.	DESCRIPTION	SIZE	THICKNESS	TILES/CASE	PRICE PER CASE		
					1	3	6+
H-6536	Blue	24 x 24"	5/8"	25	\$206	\$195	\$185
H-5833	Black						
H-5834*	Color Pack						
H-5835	Wood Grain				269	253	238

MODEL NO.	DESCRIPTION	SIZE	THICKNESS	TILES/CASE	PRICE PER CASE		
					1	3	6+
H-6537	Black	24 x 24"	1"	25	\$365	\$344	\$323
■H-6538	Black	40 x 40"	5/8"	12	281	266	250
■H-6539*	Color Pack						

■ SHIPS VIA MOTOR FREIGHT

# SOFT FLOOR CARPET TILES

Covers a 10 x 10' area in your trade show booth, basement or garage.

- Resists punctures and tears from heels and heavy traffic.
- Waterproof, EVA foam backing.

SPECIFY COLOR: Charcoal or Black

MODEL NO.	DESCRIPTION	SIZE	THICKNESS	TILES/CASE	PRICE PER CASE		
					1	3	6+
H-7901	Carpet Top	24 x 24"	5/8"	25	\$320	\$295	\$270



- Lightweight, interlocking tiles assemble in minutes.

# RUBBER GYM TILES

Interlocking tiles create cushioned surface under gym equipment.

- 95% recycled rubber, absorbs impact and reduces noise.
- Each tile includes two removable edges.
- Textured surface improves traction.

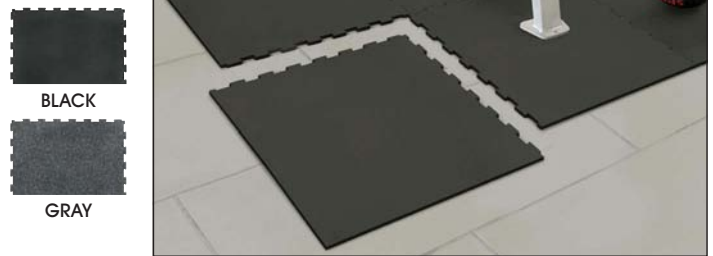

MODEL NO.	DESCRIPTION	SIZE	THICKNESS	PRICE PER TILE		
				1	6	12+
H-6540	Black	23 x 23"	3/8"	\$20	\$19	\$18

MODEL NO.	DESCRIPTION	SIZE	THICKNESS	PRICE PER TILE		
				1	6	12+
H-6541	Gray	23 x 23"	3/8"	\$22	\$21	\$20

# RUBBER GYM MATS

Protect fitness center floors from dropped weights and heavy gym equipment.

- Heavy duty recycled rubber dampens noise.
- Textured top provides traction.
- Antibacterial Gym Wipes, see page 353.

**Full-Length Rolls** – Easily cover large areas and entire sections. Install with adhesive, sold separately.



## STANDARD SIZE

MODEL NO.	SIZE	THICKNESS	WT. (LBS.)	PRICE EACH		
				1	3	6+
H-5139	4 x 6'	1/2"	70	\$149	\$142	\$135
H-7205	4 x 8'			189	179	169
H-5856	4 x 6'	3/4"	109	179	169	159

SHIPS VIA MOTOR FREIGHT

## FULL-LENGTH ROLLS

MODEL NO.	SIZE	THICKNESS	WT. (LBS.)	PRICE EACH		
				1	3	6+
■H-9399	4 x 25'	1/4"	156	\$299	\$288	\$277
■H-9400		1/2"	303	564	553	542
S-24201	Adhesive – 2 Gallon			1/\$189 ea. 3+/\$179 ea.		

■ SHIPS VIA MOTOR FREIGHT



# GRIP-TIGHT MATS



Whether used once in your muddy garage in Nebraska or for months in your rainy Seattle entryway, these adhesive-backed mats grip tight when used and peel up easily when replaced.

## CARPET

- Recommended for high-traffic use on hard surfaces.
- Cut to custom length with utility knife. Tough polyester.

## SORBENT

- Soaks up oil from machines and mud from your Gator™.
- Cut with utility knife. • Absorbs up to 21 gallons per roll.

### ENTRYWAYS

MODEL NO.	SIZE	THICKNESS	PRICE PER ROLL		
			1	3	6+
H-7947	3 x 30'	1/8"	\$190	\$185	\$180

### GARAGES

SPECIFY COLOR: Gray or Black

MODEL NO.	SIZE	THICKNESS	PRICE PER ROLL		
			1	3	4+
H-9298	34" x 50'	1/10"	\$166	\$161	\$155
H-7146	34" x 100'		306	295	285



NO MOWING, NO MAINTENANCE, NO WORRIES

# ARTIFICIAL GRASS MATS

Stays green in sun or shade without fading. UV stable.

- Quick draining, porous construction allows rain to flow through.
- Heat and frost resistant. Withstands temperatures from -20° to 160°F.
- Perfect for patios, decks and balconies.

MODEL NO.	SIZE	THICKNESS	PRICE EACH		
			1	3	6+
H-7948	3 x 5'	1½"	\$115	\$110	\$105
H-7949	5 x 8'		275	265	255
H-7950	7 x 10'		440	425	410



Mud Chucker™ – Flexible fingers scrub sides and bottom of shoes.

# SHOE/BOOT SCRAPERS

Stop dirt, sand, grass, snow, salt and mud at the door!

- Portable or bolt down. • Easy to clean.

MODEL NO.	DESCRIPTION	SIZE W x D x H	WEIGHT	PRICE EACH	
				1	2+
H-1991	Mud Chucker™	12 x 16 x 2"	5 lbs.	\$37	\$35
H-1992	Boot Scraper	17 x 15 x 7"	6 lbs.	60	56



Boot Scraper – Heavy-duty bristles. Flip up to use steel scraper bar.



# BOOT-BOY® INDUSTRIAL BOOT CLEANER

Worth every penny. Removes mud, dirt, snow, muck – everything!

- Just pull the lever. Nylon brush does all the hard work.
- Use dry or add water, degreaser or sanitizer for deep cleaning.
- For indoor and covered outdoor use. Plugs into standard outlet.

EASY ASSEMBLY. SHIPS VIA MOTOR FREIGHT.

MODEL NO.	DESCRIPTION	SIZE W x D x H	WEIGHT	PRICE EACH
H-9408	Boof-Boy®	24 x 14 x 36"	76 lbs.	\$2,500

"Fantastic product!"  
– Liz Uihlein





# HAPPY FEET™ MATS

WATER RESISTANT

Anti-slip surface plus thick cushioning = Happy Feet.

- Use in kitchens, wet labs, washing stations and assembly lines.
- Grippers on top and bottom to prevent slipping. Resist oil, grease and chemicals.
- Natural rubber cushion covered in slip-resistant nitrile.



Anti-Slip Grippers



- No-trip beveled edges.

SPECIFY COLOR: Black/Yellow or Black

MODEL NO.	DESCRIPTION	SIZE	THICKNESS	PRICE EACH		
				1	3	6+
H-3958	Happy Feet™	2 x 3'	1/2"	\$87	\$84	\$79
H-3959		3 x 5'		215	204	198

## CORRUGATED RIB RUNNERS

Economical runner protects floors and prevents slipping.

- Use in hallways, stocking corridors or entrances.
- Sweeps clean.
- Easily cuts to your desired size.



BLACK VINYL

MODEL NO.	DESCRIPTION	SIZE	THICKNESS	PRICE EACH		
				1	3	6+
H-3652	Corrugated Rib Runner	3 x 20'	1/8"	\$125	\$120	\$115
■H-1988		3 x 75'		460	440	420
■H-1990		3 x 105'		560	535	510
■H-5884		4 x 105'		745	710	675

■ SHIPS VIA MOTOR FREIGHT

## GARAGE FLOOR MATS

Instantly slick up your garage, machine shop, trailer or warehouse area.

- Tough polyvinyl cuts easily with scissors or knife.
- Resists salt, oil and water.



H-7934 – Economical floor protection. Diamond pattern.



SPECIFY COLOR: ■ Black ■ Gray

MODEL NO.	PATTERN	SIZE W x L	THICKNESS	PRICE EACH		
				1	2	4+
H-7934	Diamond	7½ x 17'	.045"	\$315	\$305	\$295
H-3154	Coin		.075"	415	405	395
H-2346	Coin Diamond	8½ x 22'	.075"	605	595	580
H-2347						

SHIPS VIA MOTOR FREIGHT

## KICK PLATES

Spruce up scruffy old doors instantly and protect from daily wear and tear.

- Prevents damage caused by hand trucks, carts or feet.

SPECIFY COLOR: ■ Stainless ■ Bronze ■ Brass

MODEL NO.	SIZE H x W	THICKNESS	QTY./CASE	PRICE EACH		
				1	5	10+
H-7955	6 x 34"	0.05"	10	\$33	\$31	\$28
H-7956	8 x 34"			44	42	39
H-7957	10 x 34"			55	53	50

Mounting screws included

- Available in 304 Stainless Steel.
- Bronze and Brass in finished aluminum.



## SPIN MOP SYSTEM

No-touch, ultra-absorbent mop cuts cleaning time in half. Spins dry in seconds.

- Recommended for marble, tile, laminate and vinyl floors.
- Use foot pedal or pump mop handle up and down to activate spinner.
- Washable microfiber mop head. Bucket with drain hole for easy emptying.



Optional Dolly sold separately

MODEL NO.	DESCRIPTION	INCLUDES	PRICE EACH	
			1	3+
H-6526	Spin Mop System	Bucket, Handle, 2 Microfiber Mop Heads	\$135	\$129
S-21791	Microfiber Mop Head	5 Replacement Heads	31	29
H-6527	Dolly with 2½" Casters		52	49

# UNIVERSAL SPILL KITS

Fast response for emergency oil, chemical and water-based liquid spills.



## BAG

For small spills in parts and maintenance areas. Compact and easy to store.

### 5-GALLON BAG

Kit Includes: (10) 15 x 19" Pads, (2) 3" x 4' Sorbent Socks, (1) pair Nitrile Gloves and Disposal Bag.

MODEL NO.	DESCRIPTION	ABSORPTION CAPACITY	PRICE EACH	
			1	5+
S-12200	5-Gallon Bag	5 gallon	\$54	\$52

## BUCKET

For small spills in garages and service areas. UN approved with screw-top lid.

### 6.5-GALLON BUCKET

Kit Includes: (10) 15 x 19" Pads, (3) 3" x 4' Sorbent Socks, (1) pair Nitrile Gloves and Disposal Bag.

MODEL NO.	DESCRIPTION	ABSORPTION CAPACITY	PRICE EACH	
			1	3+
S-23399	6.5-Gallon Bucket	9 gallon	\$110	\$105

## MOBILE CABINET

For small to medium spills in warehouses and repair shops. Compact and ready to roll on 8" plastic wheels.

## CAN WITH WHEELS

For medium spills in auto shops and manufacturing facilities. Get there quick on 8" rubber wheels.

### 25-GALLON MOBILE CABINET

Kit Includes: (1) 15" x 73' Roll, (5) 3" x 4' Sorbent Socks, (8) 10 x 10" Pillows, (1) pair Nitrile Gloves, Emergency Handbook, Goggles and (5) Disposal Bags.

MODEL NO.	DESCRIPTION	ABSORPTION CAPACITY	PRICE EACH	
			1	3+
S-23405	25-Gallon Cabinet	22 gallon	\$565	\$535
S-23406	Cabinet Refill Kit		260	240

### 50-GALLON MOBILE CAN WITH WHEELS

Kit Includes: (50) 15 x 19" Pads, (4) 3" x 12' Sorbent Socks, (8) 18 x 18" Pillows, (1) pair Nitrile Gloves, Emergency Handbook, Goggles, (5) Disposal Bags and (5) Tamperproof Seals.

SHIPS VIA MOTOR FREIGHT

MODEL NO.	DESCRIPTION	ABSORPTION CAPACITY	PRICE EACH	
			1	3+
S-21198	50-Gallon Can with Wheels	41 gallon	\$475	\$455



## SPECIALTY SPILL KITS

For kit content information, see [uline.com](http://uline.com)

### BATTERY ACID

For quick response to leaking or spilled battery acid.

- Compact enough to fit behind forklift seat. Also effective on dry cell batteries.

MODEL NO.	DESCRIPTION	ABSORPTION CAPACITY	PRICE EACH	
			1	3+
S-19486	Battery Acid	1 gallon	\$135	\$130



### MERCURY

Quickly and safely absorb spilled mercury from fluorescent light bulbs, thermometers and lab equipment.

- Complete kit handles all stages of mercury cleanup. Designed for one-time use.

MODEL NO.	DESCRIPTION	ABSORPTION CAPACITY	PRICE EACH	
			1	3+
S-19487	Mercury	25 mL	\$215	\$205

# DRUM UNIVERSAL SPILL KITS

The big dogs. Nice to have nearby where spills frequently occur.



## 20 GALLON

For small to medium spills in machine shops and laboratories. UN approved 20-gallon drum with screw-top lid.

**Kit Includes:** (12) 15 x 19" Pads, (3) 3" x 12' Sorbent Socks, (2) 18 x 18" Pillows, (1) pair Nitrile Gloves, Emergency Handbook, Goggles and (3) Disposal Bags.

## 55 GALLON

For medium spills in manufacturing facilities and industrial plants. UN approved 55-gallon drum with lever lock lid.

**Kit Includes:** (50) 15 x 19" Pads, (4) 3" x 12' Sorbent Socks, (8) 18 x 18" Pillows, (1) pair Nitrile Gloves, Emergency Handbook, Goggles and (5) Disposal Bags.

## 95 GALLON

For large spills in manufacturing plants and factories. UN and D.O.T. approved 95-gallon drum with screw-top lid.

**Kit Includes:** (110) 15 x 19" Pads, (12) 3" x 4' Sorbent Socks, (8) 3" x 12' Sorbent Socks, (8) 18 x 18" Pillows, (1) pair Nitrile Gloves, Emergency Handbook, Goggles and (10) Disposal Bags.

### 20-GALLON DRUM

MODEL NO.	DESCRIPTION	ABSORPTION CAPACITY	PRICE EACH	
			1	3+
S-18303	20-Gallon Drum	15.5 gallon	\$230	\$210

### 55-GALLON DRUM

SHIPS VIA MOTOR FREIGHT

MODEL NO.	DESCRIPTION	ABSORPTION CAPACITY	PRICE EACH	
			1	3+
S-17301	55-Gallon Drum	41 gallon	\$425	\$405

### 95-GALLON DRUM

SHIPS VIA MOTOR FREIGHT

MODEL NO.	DESCRIPTION	ABSORPTION CAPACITY	PRICE EACH	
			1	3+
S-18304	95-Gallon Drum	76 gallon	\$815	\$775



# HI-VIS UNIVERSAL SPILL KITS

## TRUCK

Carry case stows behind or under vehicle seats.

- For oil, gas or coolant spills on the road.



MODEL NO.	DESCRIPTION	ABSORPTION CAPACITY	PRICE EACH	
			1	3+
S-23400	Truck Spill Kit	14.5 gallon	\$235	\$210

**Kit Includes:** (40) 15 x 19" Pads, (3) 3" x 4' Sorbent Socks, (1) pair Nitrile Gloves, Goggles and (5) Disposal Bags.



## DRUM

Bright lime color stands out in the darkest warehouses.

- For medium spills in machine shops and warehouses.
- UN approved 30-gallon drum with screw-top lid.



MODEL NO.	DESCRIPTION	ABSORPTION CAPACITY	PRICE EACH	
			1	3+
S-22745	30-Gallon Drum	35 gallon	\$345	\$330

**Kit Includes:** (25) 15 x 19" Pads, (6) 3" x 12' Sorbent Socks, (6) 18 x 18" Pillows, (1) pair Nitrile Gloves, Emergency Handbook, Goggles and (3) Disposal Bags.



# OIL ONLY SORBENTS



Absorbs oils, fuels and petroleum-based products. Repels water.

**Rolls** – Cut to size for large area spills.

**Pillows** – Absorb oil in tight places.

**Socks** – 100% polypropylene filler. Wrap around leaky machines.

**Drum Pads** – Pre-cut to fit 55-gallon drums. 2 bung hole cut-outs.

## PADS

MODEL NO.	SIZE	DESCRIPTION	ABSORP. CAP./CTN.	QTY./CTN.	PRICE PER CARTON		
					1	3	4+
S-12889	15 x 19"	Light Pads	26 gal.	100	\$50	\$48	\$46
S-17297	15 x 19"	Medium Pads	28 gal.	100	65	62	60
S-17298	15 x 19"	Heavy Pads	35 gal.	100	82	80	77
S-24996	30 x 30"	Heavy Pads	41 gal.	50	200	193	185

## ROLLS

S-14751	30" x 150'	Medium Roll	44 gal.	1	\$128	\$123	\$118
S-24997*	15" x 150'	Heavy Roll	24 gal.	1	89	86	84
S-17299	30" x 150'	Heavy Roll	58 gal.	1	173	167	161

\* Perforated every 18"

## PILLOWS

S-24998	18 x 18"	Pillows	28 gal.	16	\$135	\$129	\$123
---------	----------	---------	---------	----	-------	-------	-------

## SOCKS

S-17300	3" x 4'	Socks	28 gal.	30	\$160	\$153	\$145
S-24999	3" x 12'		12 gal.	4	67	64	62

## DRUM PADS

S-25000	22" Diam.	Drum Pads	6 gal.	25	\$93	\$90	\$87
---------	-----------	-----------	--------	----	------	------	------



# OIL ONLY SPILL KITS



Rapid response for oil and petroleum-based spills. Repels water.

**5-Gallon Bag** – For small spills near boat launches, construction sites and metal shops. Compact – Store in your cabinet or truck.

**55-Gallon Drum** – For medium spills in marinas, refineries and loading docks. UN approved 55-gallon drum with lever lock.



For kit content information, see [uline.com](http://uline.com)

MODEL NO.	DESCRIPTION	ABSORPTION CAPACITY	PRICE EACH	
			1	5+
S-25001	5-Gallon Bag	5 gallon	\$55	\$50
■ S-25002	55-Gallon Drum	41 gallon	420	400

■ SHIPS VIA MOTOR FREIGHT



# OIL ONLY BOOMS

Control oil spills on lakes, streams and oceans. Floats on water. Mesh outer netting with polypropylene filler.

MODEL NO.	SIZE	DESCRIPTION	ABSORP. CAP./CTN.	QTY./CTN.	PRICE PER CARTON		
					1	3	4+
S-19490	5' x 10'	Booms	32 gal.	4	\$129	\$123	\$117
S-19491	8' x 10'		65 gal.	4	165	157	149

# UNIVERSAL SORBENTS

Quickly soak up oil, water, coolants and other spills.

- Low-lint, dimpled material is highly absorbent.

**Rolls** – Perforated for easy dispensing.

**Pillows** – Absorb liquids in tight places.

**Extra-Duty** – Tough, 3-ply construction handles rough surfaces.

**Drip Pans** – Trap leaks under machines, pipes and vehicles.

## PADS

MODEL NO.	SIZE	DESCRIPTION	ABSORP. CAP./CTN.	QTY./CTN.	PRICE PER CARTON		
					1	3	4+
S-17293	15 x 19"	Light Pads	44 gal.	200	\$110	\$106	\$102
S-17294	15 x 19"	Medium Pads	21 gal.	100	80	77	75
S-7247	15 x 19"	Heavy Pads	26 gal.	100	\$82 per ctn. any qty.		
S-23518	30 x 30"	Heavy Pads	41 gal.	50	202	195	187

## ROLLS

S-17295	30" x 150'	Medium Roll	38 gal.	1	\$138	\$132	\$127
S-14749	15" x 150'	Heavy Roll	24 gal.	1	91	88	86
S-7248	30" x 150'	Heavy Roll	50 gal.	1	172	165	158

## PILLOWS

S-17296	18 x 18"	Pillows	28 gal.	16	\$138	\$132	\$126
---------	----------	---------	---------	----	-------	-------	-------

## EXTRA-DUTY

S-22727	15 x 19"	Extra-Duty Pads	20 gal.	100	\$121	\$116	\$110
S-22728	30" x 150'	Extra-Duty Roll	37 gal.	1	231	221	210

## DRIP PANS

					12 pans/24 pillows		
S-25003	10 x 10"	Drip Pans	11 gal.	12	\$142	\$137	\$131

## SOCKS

**Heavy-Duty** – Polypropylene filler handles harsh chemicals.

**Super-Absorbent** – Cellulose filler soaks up large spills fast.

S-23519	3" x 4'	Heavy-Duty Socks	30 gal.	30	\$163	\$156	\$148
S-25004	3" x 8'	Heavy-Duty Socks	12 gal.	6	69	66	64
S-20628	3" x 12'	Heavy-Duty Socks	12 gal.	4	69	66	64
S-23520	3" x 4'	Super-Absorbent Socks	60 gal.	40	115	110	105

## MATS

**High Traffic Mat** – Withstands heavy foot and forklift traffic.

**Battlemat™** – Camouflage pattern hides spills, stains and grease.

**Barrier Spill Mat** – Leakproof poly backing keeps floors dry.

S-19488	30" x 300'	High Traffic Mat	63 gal.	1	\$246	\$236	\$225
S-19489	30" x 150'	Battlemat™	52 gal.	1	236	226	215
S-20085	36" x 100'	Barrier Spill Mat	25 gal.	1	222	212	203

## DRUM PADS

Pre-cut to fit 55-gallon drums. 2 bung hole cut-outs.

S-14750	22" Diam.	Drum Pads	6 gal.	25	\$95	\$92	\$89
---------	-----------	-----------	--------	----	------	------	------

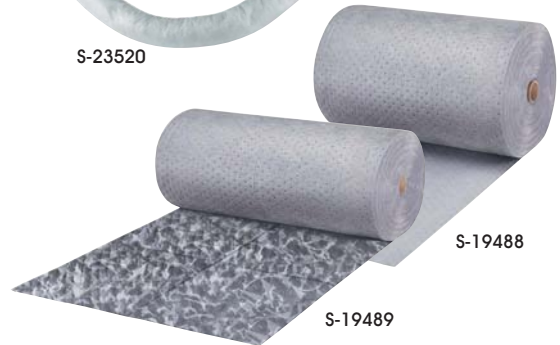

# HAZMAT SORBENTS

Soak up spills of corrosive liquids, acids and bases.

MODEL NO.	SIZE	DESCRIPTION	ABSORP. CAP./CTN.	QTY./CTN.	PRICE PER CARTON		
					1	3	4+
S-14748	15 x 19"	Medium Pads	30 gal.	100	\$90	\$87	\$84
S-21765	15 x 19"	Heavy Pads	34 gal.	100	115	111	107
S-21766	30" x 150'	Medium Roll	44 gal.	1	140	135	130

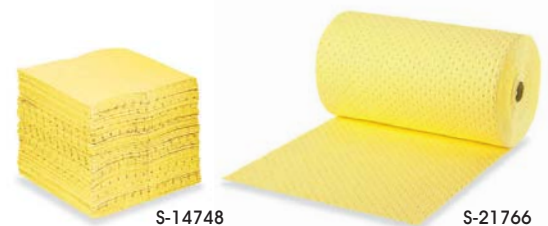



# SWEEPING COMPOUNDS

## INDUSTRIAL

Floor cleaner for finished and unfinished floors.



### OIL BASED

MODEL NO.	SIZE	DESCRIPTION	RECOMMENDED USE	PRICE EACH		
				1	3	6+
S-3405	50 lb.	Oil, Sand and Sawdust	Unfinished Floors	\$23	\$22	\$21
S-6078	100 lb.			38	36	34
S-6632	300 lb.			135	130	125
S-6633	50 lb.	No Grit – Oil and Sawdust	Finished Floors	32	31	30
S-6862	100 lb.			62	60	58
S-12888	200 lb.			135	130	125

200 lb. Drum

SHIPS VIA MOTOR FREIGHT

## GREEN SWEEP

Universal – Works on all floor surfaces, finished and unfinished.

- Environmentally safe. Meets MN laws.



MODEL NO.	SIZE	DESCRIPTION	RECOMMENDED USE	PRICE EACH		
				1	3	6+
S-6634	50 lb.	Water, Sand and Sawdust	Finished and Unfinished Floors	\$20	\$19	\$18
S-6635	100 lb.			35	33	31
S-11668	300 lb.			113	108	103
S-25014	50 lb.	No Grit – Water and Sawdust	Delicate and Finished Floors	26	25	24
S-25015	200 lb.			115	110	105

SHIPS VIA MOTOR FREIGHT



## OIL-DRI®

Quickly absorbs spills. Pour it on; sweep it off.

- Recommended for warehouses, shops and garages.
- Soaks up oil, grease, water and odors.

Quick-Sorb™ Concentrate – Economical container absorbs twice as much as Oil-Dri® bag.

MODEL NO.	SIZE	DESCRIPTION	QTY./SKID	PRICE EACH (MIN. 3)			SKID LOTS
				3	6	10+	
S-11683	32 qt.	Oil-Dri® Bag	45	\$18.25	\$17.75	\$17.25	\$15.50
S-11684	20 lb.	Quick-Sorb™ Oil-Dri® Pail	60	26.25	25.75	25.25	23.50

SHIPS VIA MOTOR FREIGHT



## LIQUID ICE MELT New



Quick and even application for sidewalks or metal-grated steps.

- Calcium chloride formula won't harm grass or plants.
- Residue free, no cleanup needed. Won't track indoors.
- Nontoxic. Melts ice up to -20°F.

Apply using Pressure Sprayers, see [uline.com](http://uline.com)



SOLD IN CASE QUANTITIES

MODEL NO.	DESCRIPTION	QTY./BOTTLE	QTY./CASE	PRICE EACH		
				1	4	8+
S-25016	Liquid Ice Melt	1 gal.	4	N/A	\$19	\$18
S-25017		55 gal.	1	\$410	400	390

SHIPS VIA MOTOR FREIGHT

## PET SAFE ICE MELT

Safer for kids, pets and Mother Nature.

- Enhanced with CMA (calcium magnesium acetate).
- Forms a protective coating on sidewalks and entryways.
- Nontoxic. Melts ice up to -12°F.

FREE H-879 Scoop with \$100+ order of Ice Melt.



MODEL NO.	DESCRIPTION	SIZE	PRICE EACH	
			1	5+
S-23254	Pet Safe Ice Melt	50 lb. Bag	\$32	\$30
H-879	Ice Melt Scoop	2 Qt.	8	7





## ICE MELT

FREE H-879 Scoop with \$100+ order of Ice Melt.

Won't harm grass, plants or carpets.

- Melts ice up to -16°F. • Use with Ice Melt Spreaders.
- Reusable Pail – Easy to store and transport. Ready to use at any door.

MODEL NO.	DESCRIPTION	SIZE	QTY./SKID	PRICE EACH		SKID LOTS
				1	5+	
S-7125	Ice Melt	50 lb. Bag	50	\$21	\$20	\$18
S-14954		40 lb. Pail	36	26	25	23

### ACCESSORIES

MODEL NO.	DESCRIPTION	SIZE	PRICE EACH	
			1	3+
H-879	Scoop	2 Qt.	\$8.00	\$7.00
H-1468	Ice Melt Pail Opener		\$7.95 each	



## ICE MELT SPREADERS

Spread ice melt, sand or rock salt with no clogging.

- Rustproof plastic hoppers hold up to 100 lbs.

For more information, see [uline.com](http://uline.com)

MODEL NO.	CAPACITY (LBS.)	HOPPER DIM. H x W x D	WT. (LBS.)	PRICE EACH
H-2813	65	12 x 20 x 16"	15	\$225
H-9932	100	14 x 22 x 22"	29	565



## HEAVY-DUTY SHOVELS

Deep scoop easily picks up absorbents, bulk grains and seeds.

- One-piece construction with no seams or crevices where bacteria can hide.
- Virtually unbreakable. Takes a beating. Withstands harsh temperatures.

**Polypropylene** – Use a different color for each area in your facility to prevent cross-contamination.

**Type 304 Stainless Steel** – Resists harsh cleanings and corrosive environments.



\* SPECIFY COLOR: Orange Red Blue Green White Yellow Black Purple

MODEL NO.	DESCRIPTION	OVERALL LENGTH	BLADE SIZE	WT. (LBS.)	PRICE EACH		
					1	3	6+
H-5043*	Polypropylene	42"	14 x 17"	4	\$57	\$54	\$51
H-8484	Stainless Steel	39"	14 x 11"	5	215	210	205



## SNOW SHOVELS

Push aside snow and slush to keep walks and entryways clear.

**Poly Shovel** – Snow and ice slide off this tough blade.

**Aluminum Pusher** – Cuts through wet, slushy snow.



H-1656

H-1655

MODEL NO.	DESCRIPTION	OVERALL LENGTH	BLADE SIZE	WT. (LBS.)	PRICE EACH	
					1	3+
H-1655	Poly Blade	51"	20 x 13"	7	\$33	\$31
H-1656	Alum. Blade	57"	24 x 12"	10	60	58

## JUMBO STORAGE BINS

Safely store ice melt, sand or fertilizer.

- Non-corrosive polyethylene. Weather resistant.
- Built-in forklift channels. 2-way access.



H-5044

Extra Large – Lockable, hinged lid.

\* Blue

■ SHIPS VIA MOTOR FREIGHT

MODEL NO.	DESCRIPTION	OUTSIDE DIM. L x W x H	CU. FT. CAP.	CAP. (LBS.)	WT. (LBS.)	PRICE EACH	
						1	2+
H-8806*	Standard	30 x 25 x 24"	5½	500	21	\$188	\$168
■ H-5044	Extra Large	42 x 29 x 30"	11	1,000	50	360	340



Fatal attraction for dust, dirt and debris.

**Economy** – Treated cotton yarn picks up dust like a magnet. Ideal for spot dust mopping under equipment or behind furniture.

**Deluxe** – Launderable 2-ply construction features cotton yarn sewn to a synthetic backing. Long-lasting, durable construction.

5 COLORS AVAILABLE



\*SPECIFY COLOR: Blue Red Green Orange Yellow

## DUST MOPS

MODEL NO.	WIDTH	DESCRIPTION	INCLUDES	PRICE EACH		
				1	3	6+
H-2843	24"	Economy	Dusting Head, Fiberglass Handle and Frame	\$27	\$25	\$23
H-865	36"			31	29	28
H-1134	48"			34	32	30
H-2280	60"			38	36	34
H-866*	24"	Deluxe	Dusting Head, Fiberglass Handle and Frame	33	31	29
H-867*	36"			42	39	37
H-874*	48"			48	45	43
H-1919	60"			62	57	54
H-3987	72"			72	68	64
S-7117	24"			Economy	Replacement Dusting Head	10
S-7118	36"	11	10			9
S-9990	48"	12	11			10
S-14791	60"	15	14			13
S-7119*	24"	Deluxe	Replacement Dusting Head	14	13	12
S-7120*	36"			20	19	18
S-7270*	48"			25	24	23
S-13704	60"			37	36	35
S-19687	72"			44	43	42
H-865-HANDLE	Universal Replacement Handle			1/\$18	2+/\$16	
S-14792	Dust Mop Spray – 16 oz.			3/\$10.50	6+/\$9.50	



Grabs and holds dust and dirt with looped microfiber.

- No cleaning spray needed.
- Works well on tile floors.
- Mop head is machine washable up to 200 times.

## MICROFIBER DUST MOPS

MODEL NO.	WIDTH	DESCRIPTION	INCLUDES	PRICE EACH		
				1	3	6+
H-6535	24"	Deluxe	Dusting Head, Handle and Frame	\$38	\$36	\$34
H-3474	36"			43	41	39
H-3475	48"			49	47	45
H-8493	60"			82	80	77
S-21805	24"	Deluxe	Replacement Dusting Head	17	16	15
S-18411	36"			22	21	20
S-18412	48"			27	26	25
S-23411	60"			35	34	33
H-865-HANDLE	Universal Replacement Handle			1/\$18	2+/\$16	

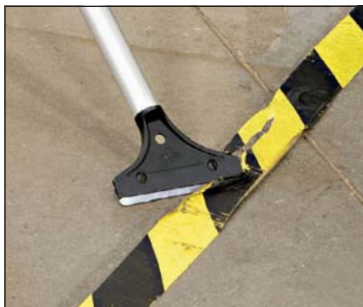

## FLOOR SCRAPERS

Remove gum, tape and wax buildup from floors, baseboards and sidewalks.

**Handheld** – 4" wide scraper, 12" long aluminum handle.

**Light Duty** – 4" wide scraper, 48" long aluminum handle.

**Heavy Duty** – 8" wide scraper, 60" long steel handle.



10 Blades/Pack

MODEL NO.	DESCRIPTION	PRICE EACH			REPLACEMENT BLADES	
		1	3	6+	MODEL NO.	PRICE/PACK
H-3451	4" Handheld	\$28	\$27	\$26	H-2583B	\$14
H-2583	4" Light Duty	29	28	27	H-2583B	14
H-2842	8" Heavy Duty	87	85	83	H-2842B	36



# WET MOPS

Perfect for scrubbing, damp mopping and all-purpose cleaning.

**Heavy Duty** – Blended yarns provide excellent durability and absorption.



SPECIFY COLOR: Blue Red White Green Orange

MODEL NO.	SIZE	DESCRIPTION	RECOMMENDED USE	PRICE EACH		
				6	12	24+
S-7121	24 oz.	Economy	Disposable, Short-Term Use	\$7.25	\$6.50	\$6.25
S-7122	16 oz.	Heavy Duty	Launderable, Long-Lasting	10.00	9.75	9.00
S-7271	24 oz.			<b>\$9.95 each any qty.</b>		
S-14793	32 oz.			13.50	12.50	11.50
H-872	60"	Wood Handle	Fits Mop Heads	1/\$13.50	3+/\$13.00	



**Economy** – Tough, durable cotton mop with a 1 inch headband.



**Heavy Duty** – 4-ply looped cotton yarn for tangle-free mopping.

# MICROFIBER WET MOPS

Superior liquid and dirt pickup. Lasts twice as long.

- Floors dry faster without streaking.
- Mildew-resistant microfiber lints less than cotton.

SPECIFY COLOR: Blue, White or Green

MODEL NO.	SIZE	DESCRIPTION	RECOMMENDED USE	PRICE EACH		
				6	12	24+
S-18366	24 oz.	Economy	Disposable, Short-Term Use	\$8.50	\$7.75	\$7.00
S-18367	24 oz.	Heavy Duty	Launderable, Long-Lasting	16.00	15.00	14.00
H-872	60"	Wood Handle	Fits Mop Heads	1/\$13.50	3+/\$13.00	

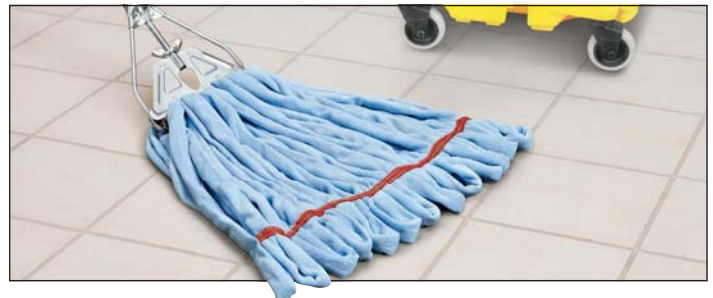

**Economy** – Deep cleans smooth surfaces. Won't fray.



**Heavy Duty** – Glides over rough surfaces. Won't tangle.

# TOUCHLESS WET MOPS



Jaw-style clamp reduces contact with dirty mops.

- Thick 5 inch wide headband releases easily.
- 4-ply looped cotton yarn.



SPECIFY COLOR: Blue, White or Green

MODEL NO.	SIZE	DESCRIPTION	RECOMMENDED USE	PRICE EACH		
				6	12	24+
S-24701	24 oz.	Heavy Duty	Launderable, Long-Lasting	\$13	\$12	\$11
H-9948	60"	Clamp Handle	Fits Mop Heads	1/\$26	3+/\$24	

# FINISHING WET MOP

Apply floor finish smoothly, without streaking. Low lint.

- 4-ply poly/rayon head will not fray or tangle.
- Liquids spread evenly.



MODEL NO.	SIZE	DESCRIPTION	RECOMMENDED USE	PRICE EACH		
				6	12	24+
S-19420	24 oz.	Heavy Duty	Launderable, Long-Lasting	\$13	\$12	\$11
S-24848	1 gal.	High Gloss Floor Finish		1/\$39	4+/\$37	

# MOP HANDLES

Comfortable, lightweight replacement handles.

FIBERGLASS SPECIFY COLOR: Yellow, Blue, Gray, Red or Green

MODEL NO.	LENGTH	HEAD STYLE	PRICE EACH	
			1	3+
H-3741	60"	Gate	\$19	\$18
H-4504	60"	Quick Change	20	19

**Gate** – Twist-and-release.

**Quick Change** – No touch, fast-action lever.

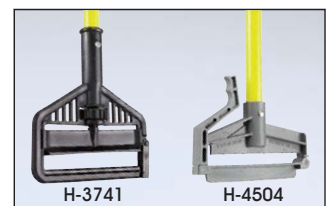



# MICROFIBER SYSTEMS

## ULINE MOP



- Removes most dirt, dust and debris without chemicals.
- Change pads in seconds with attached hook and loop fasteners.

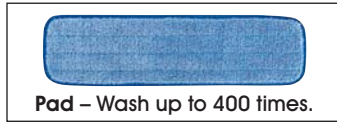

Make less trips to the bucket. Microfiber pads hold more water than traditional mops for more efficient cleaning.

MODEL NO.	WIDTH	DESCRIPTION	INCLUDES	PRICE EACH		
				1	3	6+
H-4506	18"	Heavy Duty	Wet Mop Pad, Handle and Frame	\$31	\$29	\$27
S-20083	18"	Heavy Duty	Replacement Wet Mop Pad	10	9	8
H-4507	6 Gallon Bucket with Lid			41	39	38

## RUBBERMAID® HYGEN™

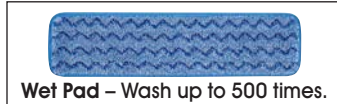

Deep clean without chemicals. Recommended for healthcare and food services.

- Textured pads trap 25% more dirt.
- Long pads fit in this large mobile bucket.



Disposable Mop Pads – Eliminate 99.7% of microbes.

MODEL NO.	WIDTH	DESCRIPTION	PRICE EACH		
			1	3	6+
S-23381	21"	Replacement Wet Mop Pad	\$16	\$15	\$13
S-23382	19"	Disposable Mop Pads – 150/ctn.	155	150	145

MODEL NO.	WIDTH	DESCRIPTION	INCLUDES	PRICE EACH		
				1	3	6+
H-8495	21"	HYGEN™	Wet Mop Pad, Handle and Frame	\$59	\$56	\$52
H-8496	11 Gallon Bucket with Wheels			125	120	115

## SWIFFER® WETJET

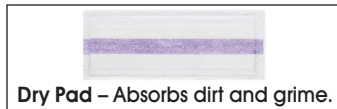

Cuts grease and loosens dirt with the push of a button.

- Quick and easy cleanup for breakrooms, small kitchens and shipping areas.
- Safe for linoleum, vinyl, ceramic and finished floors.

H-8848 Starter Kit Includes: 1 mop, 1 bottle of solution, 5 dry mop pads and 4 AA batteries.

MODEL NO.	WIDTH	DESCRIPTION	QTY./PACK	PRICE PER PACK	
				1	4+
S-23822	11"	Dry Mop Pads	24	\$24	\$22
S-25481	42 oz. Solution Refill – 2 pk.		3/\$22 ea. 9+/\$20 ea.		

MODEL NO.	WIDTH	DESCRIPTION	PRICE EACH	
			1	2+
H-8848	10"	WetJet Starter Kit	\$42	\$39

## 49' TELESCOPIC POLE

Reach the highest windows, ceiling fans and rafters in warehouses, gyms and auditoriums.

- Carbon fiber delivers maximum strength in lightweight pole.
- Minimal flex even at full extension.
- Includes deluxe carrying case for storage and transport.



UNGER®

MODEL NO.	DESCRIPTION	PRICE EACH			1 YEAR WARRANTY	SHIPS VIA UPS
		1	3	6+		
H-6491	22" Squeegee	\$29	\$28	\$27	H-9975	7-49' Carbon Fiber Telescopic Pole
H-2281	18" Window Washer	27	26	25		
H-3453	14" Combo Tool	51	49	47		
					WT. (LBS.)	PRICE EACH
					12	\$3,300



# INDUSTRIAL FLOOR SQUEEGEES



RUBBER

FOAM

Clean up and dry warehouse floors.

- Straight squeegee for general-purpose use.
- Curved squeegee keeps water contained.

Foam – Deep cleans and dries tiled and uneven surfaces.

HANDLE SOLD SEPARATELY

MODEL NO.	DESCRIPTION	PRICE EACH		
		1	3	6+
H-1354	24" Straight Rubber	\$38	\$37	\$36
H-10345	24" Curved Rubber	49	48	47
H-1355	36" Curved Rubber	52	51	50
H-2849	30" Foam	35	34	33
H-1356	61" Aluminum Handle	27	26	25

# COLORED FLOOR SQUEEGEES

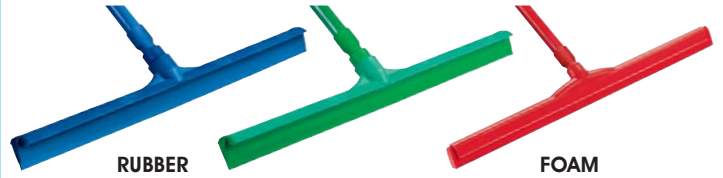

RUBBER

FOAM

Keep floors clean and dry in bakeries, breweries and food processing plants.

- Color coding reduces the risk of cross-contamination.
- Rustproof plastic frame with 60" fiberglass handle.

Rubber – For smooth, coated concrete and commercial floors.

Foam – Deep cleans grouted tile and uneven surfaces.

SPECIFY COLOR: White Yellow Orange Red Blue Green Black

MODEL NO.	DESCRIPTION	PRICE EACH		
		1	3	6+
H-6490	24" Straight Rubber	\$49	\$48	\$47
H-7579	24" Straight Foam	53	52	51

FDA COMPLIANT

# AQUADOZER® MAX FLOOR SQUEEGEES



Moves twice as much water as standard squeegees.

- Double the height with extended hood and rubber blade.

36" Straight – For mud, slush, snow and debris.

36" Curved – For deep standing water and flood cleanup.



STRAIGHT

CURVED

HANDLE SOLD SEPARATELY

MODEL NO.	DESCRIPTION	PRICE EACH		
		1	3	6+
H-7580	36" Straight Rubber	\$68	\$66	\$63
H-7581	36" Curved Rubber	74	72	69
H-1356	61" Aluminum Handle	27	26	25

# INDUSTRIAL WINDOW SQUEEGEES



WINDOW SQUEEGEE



WINDOW WASHER



COMBO TOOL



BUCKET

Keep glass clean and streak-free with these professional stainless steel squeegees.

Window Washer – Soap and scrub your windows, screens and walls before using squeegee. Machine washable.

Combo Tool – 2-in-1 washer and squeegee combo for fast, easy cleaning.

Ninja Scraper – Removes stubborn residue. Flexible head switches from 0° to 30°.

Bucket – For squeegees up to 18" wide. Tough polypropylene.

Tablets – Individually wrapped. Dissolve in 2½ gallons of water to clean glass.



SCRAPER

## SQUEEGEES

POLE SOLD SEPARATELY

MODEL NO.	DESCRIPTION	PRICE EACH		
		1	3	6+
H-1349	12" Squeegee	\$23	\$22	\$21
H-1350	18" Squeegee	25	24	23
H-6491	22" Squeegee	29	28	27
H-2281	18" Window Washer	27	26	25
H-3453	14" Combo Tool	51	49	47
H-10346	18" Combo Tool	69	67	65

## POLES

MODEL NO.	DESCRIPTION	PRICE EACH		
		1	3	6+
H-1920	4-8' Telescopic Pole	\$49	\$47	\$45
H-6056	7-18' Telescopic Pole	100	96	92
H-7228	8-30' Telescopic Pole	190	185	180

## ACCESSORIES

\* Min. 10 Packs

MODEL NO.	DESCRIPTION	1	3	6+
H-7582	Ninja Scraper	\$28	\$27	\$25
H-2847	6 Gallon Bucket	47	45	44
S-21778*	Glass Cleaner Tablets – 10/Pack	10/\$8.00 ea. 20+/\$7.50 ea.		

## COLORED PUSH BROOMS



Recommended for use in food processing and prep areas.

- Color coding reduces the risk of cross-contamination.
- Angled polypropylene bristles for fast, effective sweeping.

SPECIFY COLOR: Black, Yellow, Orange, Red, Blue or Green

MODEL NO.	DESCRIPTION	WIDTH	PRICE EACH		
			1	3	6+
H-3460	Push Broom	24"	\$49	\$48	\$47

## COLORED ANGLE BROOMS



Grabs dirt from corners and around appliances.

- Color coding reduces the risk of cross-contamination.
- Sanitary, chemical-resistant polypropylene bristles.

SPECIFY COLOR: Blue, Red, Green, Yellow, Orange or Black

MODEL NO.	DESCRIPTION	WIDTH	PRICE EACH		
			1	3	6+
H-3976	Angle Broom	12"	\$37	\$36	\$35



## COUNTER BRUSHES

Clean counters and workbenches.

**Horsehair** – Sweeps up extra-fine dust and dirt. Non-scratching.

**Polypropylene** – For wet or dry use. Color code to prevent cross-contamination.

\* SPECIFY COLOR: Black Red Blue Green

MODEL NO.	DESCRIPTION	HANDLE	BRUSH WIDTH	PRICE EACH (MIN. 2)		
				2	6	12+
H-3473*	Medium Polypropylene	Plastic	8"	\$10.50	\$10.00	\$9.00
H-2509	Extra-Fine Horsehair	Wooden		16.50	15.50	14.50



## JUMBO DUST PANS

Popular choice for construction sites and outdoor use.

- Durable, high-impact plastic pan with aluminum handle.
- Locking handle swings down for hanging storage.

SPECIFY COLOR: Black, Red, Blue or Yellow

MODEL NO.	DESCRIPTION	DIMENSIONS H x W x D	PRICE EACH		
			1	3	6+
H-6497	Dust Pan	33 x 13 x 14"	\$35	\$34	\$33



## CORN BROOMS

Reach more places...

- Use in garages, warehouses and receiving docks.
- Excellent for rough surfaces.

**Whisk Broom** – Sweep off workbenches and machinery.



MODEL NO.	DESCRIPTION	WIDTH	QTY./ CASE	PRICE EACH		
				2	6	12+
H-1622	Broom	11"	1	\$17	\$16	\$15
H-6498	Whisk Broom	7.5"	3	1/\$16 cs. 2+/\$15 cs.		

## MAXIMIZER™ BROOMS AND DUST PAN

Sweep up wet or heavy debris in kitchens and breakrooms.

**Dust Pan** – Extra-wide pan with locking latch for spill-free lifting. Holds up to 25 lbs.

**Broom** – Angled ends funnel dirt toward center for fast cleanup. Polypropylene bristles.



RUBBERMAID®

MODEL NO.	DESCRIPTION	DIMENSIONS H x W x D	PRICE EACH		
			1	3	6+
H-7202	Dust Pan	32 x 21 x 15"	\$52	\$50	\$47

MODEL NO.	DESCRIPTION	DIMENSIONS H x W x D	PRICE EACH		
			1	3	6+
H-7203	Push Broom	61 x 18 x 4"	\$50	\$47	\$45
H-7431		61 x 36 x 4"	71	68	64



# WAREHOUSE CLEANING SUPPLIES

## DUST PANS

### PLASTIC

Jumbo Dust Pan – Large 18" width with 4" height. Rubber feet prevent slipping.

Standing Dust Pan – 27" handle saves your back.



### STEEL

Dust Pan – Rugged and long lasting.

Standing Dust Pan – Self-closing. 29" handle.



MODEL NO.	WIDTH	DESCRIPTION	PRICE EACH		
			1	3	6+
H-525	18"	Plastic Pan	\$16	\$15	\$14
H-799	12"	Plastic Standing	27	26	25
H-1348	12"	Steel Pan	11	10	9
H-2276	16"	Steel Pan	16	15	14
H-1623	12"	Steel Standing	43	41	39

## COLORED DECK BRUSHES

New

Scrub floors and walls in breweries, dairy plants and commercial kitchens.

- 59" fiberglass handle with stiff polyester bristles.
- Color coding reduces the risk of cross-contamination.



SPECIFY COLOR: Blue, Black, Yellow, Red, White or Green

MODEL NO.	WIDTH	DESCRIPTION	PRICE EACH		
			1	3	6+
H-10946	12"	Deck Brush	\$90	\$87	\$84

## DELUXE BROOMS



**FINE** – Fine, crimped polypropylene bristles.  
**MEDIUM** – Stiff bristles inside, fine bristles outside.  
**HEAVY** – Stiff polypropylene bristles.

Sturdy steel-encased bristle block won't crack or warp.

- Brush angle adjusts for sweeping under tables and racks.
- Polypropylene bristles resist water, chemicals and acids.

MODEL NO.	WIDTH	DESCRIPTION	RECOMMENDED USE	PRICE EACH		
				1	3	6+
H-553	24"	Fine Bristles	Finished Floors: Offices and Cafeterias	\$49	\$48	\$47
H-744	36"			71	69	67
H-845	24"	Medium Bristles	Semi-Smooth Floors: Wood, Warehouses, All Purpose	49	48	47
H-846	36"			71	69	67
H-798	11"	Heavy Duty Upright	Unfinished Floors: Rough Surfaces, Blacktop	37	36	35
H-847	24"	Heavy Bristles		49	48	47
H-552HANDLE		58" Threaded Replacement Handle		\$21 each		

## CONTRACTOR BROOMS

Use at worksites or on concrete.

- Metal braces prevent unthreading and provide additional support.
- Sweep up dust and heavy debris.

H-1929 and H-1673 – Heavy-duty, rugged construction for the toughest jobs.



MODEL NO.	WIDTH	DESCRIPTION	RECOMMENDED USE	PRICE EACH		
				1	3	6+
H-6960	24"	Fine Bristles	Finished Floors: Offices and Cafeterias	\$28	\$27	\$26
H-6961	30"			36	35	34
H-1620	24"	Medium Bristles	Semi-Smooth Floors: Wood, Warehouses, All Purpose	28	27	26
H-1621	30"			36	35	34
H-3831	36"			42	41	40
H-1929	24"	Heavy Bristles	Unfinished Floors: Rough Surfaces, Blacktop	28	27	26
H-1673	30"			36	35	34
H-3455		60" Bolt Tip Replacement Handle		\$9 each		



## GARAGE BROOMS

Sweep heavy, wet or dry dirt and debris.

- Stiff, long-lasting 4" palmyra bristles.

MODEL NO.	WIDTH	RECOMMENDED USE	PRICE EACH		
			1	3	6+
H-2277	24"	Concrete, Brick, Rough Surfaces	\$26	\$25	\$24
H-2278	30"		33	32	31

# DEWALT® WET/DRY VACUUMS

1 YEAR WARRANTY

## CLASSIC

Quiet running wet/dry vacuums tackle the messiest spills.

- Swivel casters, tip resistant.

**5.5 HP** – Excellent for garages, commercial buildings and medium-sized stores.

**6.5 HP** – Extra power and capacity for car dealerships, construction sites and healthcare facilities.

## STAINLESS STEEL

Powerful suction cleans up metal shards, water, sawdust and debris.

- Durable stainless steel construction for foundries, machine shops and job sites.
- Conformable canvas bin for convenient tool storage.



DEWALT®

MODEL NO.	DESCRIPTION	GALLON CAPACITY	AMPS	PATH WIDTH	WT. (LBS.)	PRICE EACH		
						1	2	3+
H-8902	5.5 HP	12	10	Up to 14"	25	\$215	\$210	\$205
H-8903	6.5 HP	16	12	14"	34	285	275	265
H-8931	6.5 HP Stainless Steel	10	10	Up to 10"	25	290	280	270

## REPLACEMENT FILTERS AND BAGS

MODEL NO.	DESCRIPTION	QTY./CTN.	PRICE/CTN.	
			1	2+
S-24031	Cartridge Filter	1	\$31	\$29
S-24033	High Efficiency Filter	1	46	43
S-24039	Replacement Bags for H-8931	3	33	31
S-24040	Replacement Bags for H-8902, H-8903	3	36	34

### Accessories:

7' hose, 2 extension wands, 6½" utility nozzle, floor brush, round brush, crevice tool, washable cartridge filter and disposable filter bag.

### Replacement Filters and Bags

Filters – Wet or dry vacuuming. Trap fine particles and dust.

Bags – Dry vacuuming only. Collect debris, cement and drywall dust.

# TORNADO® WIDE AREA VACUUM

Does the work of 3 vacuums. Clean up to 10,000 sq. ft. per hour.

- For carpeted areas in theaters, malls and convention centers.
- **75'** cord. 4-stage clean air filtration removes 99.97% of particles.
- Ergonomic adjustable handle. Fold down and stand unit on end for storage.
- Two high-efficiency motors. 5 carpet height adjustments.
- UL/C-UL Listed.



BIG SUCKER

2 YEAR WARRANTY

MODEL NO.	DESCRIPTION	CFM	AMPS	PATH WIDTH	DIMENSIONS H x D x W	WT. (LBS.)	PRICE EACH	REPLACEMENT BAGS 10 PK.	
H-7645	46 Qt.	224	14	30"	42 x 36 x 30"	95	\$2,835	H-7645-HEPA	\$47

SHIPS VIA MOTOR FREIGHT

# INDUSTRIAL BACKPACK VACUUMS

PROTEAM®

Superior suction, comfort and filtration. Clean office buildings and schools without fatigue.

- 4-stage HEPA filtration removes 99.97% of particles. **50'** cord.
- Fully adjustable harness conforms to back for a perfect fit. Mesh padding for all-day comfort.
- Slim profile reduces bumps to walls and doorways.
- **Accessories:** All-in-one carpet/bare floor nozzle, 44-58" adjustable aluminum wand, hose, crevice tool, upholstery tool and dust brush. Two bags included.



MODEL NO.	DESCRIPTION	CFM	AMPS	PATH WIDTH	DIMENSIONS H x D x W	WT. (LBS.)	PRICE EACH		REPLACEMENT BAGS 10 PK.	
							1	2+		
H-6460	6 Qt.	153	9.5	14"	18 x 7 x 10"	11.6	\$640	\$605	S-21745	\$20
H-5048	10 Qt.				23 x 7 x 10"		675	635	S-20686	24

# SANITAIRE® COMMERCIAL VACUUMS

Commercial-duty cleaning for offices, motels and reception areas.

- Meets OSHA requirements. UL/C-UL Listed. • One bag included.
- Use Replacement Bags for excellent microfiltration.

## INDUSTRIAL VACUUM

Easiest vacuum to maneuver that Uline sells. Easy roll rubber wheels.

- Ergonomic handle. • 2 speeds – Standard and quiet mode.
- Steel base and hood. • 6 carpet height adjustments.

## WIDE TRACK INDUSTRIAL VACUUM

38% wider cleaning path. Sucks up dirt in one quick pass.

- Works well on Waterhog™ Mats. • Reliable 1 speed motor.
- Steel base and hood. • 6 carpet height adjustments.

MODEL NO.	DESCRIPTION	CFM	AMPS	PATH WIDTH	CORD	WT. (LBS.)	PRICE EACH		REPLACEMENT BAGS 5 PK.	
							1	2+		
H-3480	Industrial	145	7	13"	50'	16	\$330	\$320	S-13926	\$16
H-10152	Wide Track			18"		17	455	445		



H-3480  
13" INDUSTRIAL

H-10152  
18" WIDE INDUSTRIAL

## BAGLESS HEPA VACUUM

Powerful motor captures allergens and pollens. Large, 3.5-quart dust cup eliminates bags. 7 carpet height adjustments.

- Washable HEPA filter captures 99.97% of allergens.
- Tools: Nesting wand, crevice tool, dusting brush and 3:1 stretch hose.

## EON® QUIETCLEAN® VACUUM

Never change a belt again. Cogged belt reduces downtime.

- 4 height adjustments for carpeted and uncarpeted floors. HEPA filter.
- Tools: Nesting wand, crevice tool and dusting brush with reinforced stretch hose.

MODEL NO.	DESCRIPTION	CFM	AMPS	PATH WIDTH	CORD	WT. (LBS.)	PRICE EACH		REPLACEMENT BAGS 5 PK.	
							1	2+		
H-2665	Bagless HEPA	135	10	15"	40'	18	\$355	\$345	–	–
H-7147	EON® QuietClean®	105		12"		17	500	485	S-22345	\$5



H-2665  
BAGLESS HEPA

H-7147  
EON® QUIETCLEAN®



### Accessories:

12' hose, 4 1/2" claw nozzle and high-efficiency cartridge filter.

## INDUSTRIAL DRUM TOP VACUUM

The Big Dog. For industrial-size spills and debris.

- Powerful 2-stage bypass motor sucks up wood chips, metal shavings, spills and construction debris.
- Fits any 55-gallon, open-top steel drum. Held in place by suction.



Recommended for use with S-10758

MODEL NO.	DESCRIPTION	CFM	AMPS	PATH WIDTH	CORD	WT. (LBS.)	PRICE EACH		
							1	2	3+
H-9353	6.0 HP Drum Top	110	9	4 1/2"	15'	26	\$820	\$810	\$800
■ S-10758	55-Gallon Open-Top Steel Drum					43	\$149 ea. 4+/\$143 ea.		

Replacement filters available, see [uline.com](http://uline.com)

■ SHIPS VIA MOTOR FREIGHT



# TORNADO® COMMERCIAL VACUUMS

Industrial vacuums for cleaning commercial buildings, resorts and lobbies.

- 3-stage HEPA filtration removes 99.97% of allergens.

## LIGHTWEIGHT

Our lightest vacuum. Only 8 lbs. For carpeted surfaces and hard floors.

- Low profile design lays completely flat to reach under furniture.
- Old-school style. Automatically adjusts to carpet height.

## DELUXE HEPA

Superior suction cleans Waterhog™ mats and thick carpets.

- 100% sealed HEPA filtration for healthcare and medical settings.
- Multiple carpet height adjustments. Full bag and clog indicator.
- Tools: Extension wand, crevice tool, upholstery tool and dusting brush.

\*6 per pack

MODEL NO.	DESCRIPTION	CFM	AMPS	PATH WIDTH	CORD	WT. (LBS.)	PRICE EACH		REPLACEMENT BAGS 10 PK.	
							1	2+		
H-10166	Lightweight	160	6	14"	50'	8	\$380	\$370	S-24940*	\$30
H-10400	Deluxe HEPA	102	9	12"	40'	17	695	675	S-25022	20



H-10166  
LIGHTWEIGHT

H-10400  
DELUXE HEPA

H-9934  
CORDLESS

## CORDLESS

Propels itself, making chores a breeze. Lightweight and easy to maneuver.

- Go anywhere! For cleaning high-traffic hallways and theaters.
- Battery provides 50 minutes of fade-free operation. Recharges in under 2 hours. Automatically adjusts to carpet height.

1 YEAR WARRANTY

MODEL NO.	DESCRIPTION	CFM	PATH WIDTH	CORD	WT. (LBS.)	PRICE EACH		REPLACEMENT BAGS 10 PK.	
						1	2+		
H-9934	Cordless	60	13"	N/A	11	\$850	\$830	S-24682	\$31

Battery and charger included

## CARPET EXTRACTOR

TORNADO®

Remove stains and devour dirt on filthy carpets in offices and hospitals.

- Powerful 100 psi pressure and agitating brush penetrate fibers for a deeper clean.
- 3-stage, heavy duty motor sucks up dirty water and your cleaning solution for faster drying times.
- 50' cord and large 12" rubber wheels.
- 9-gallon solution tank. 9-gallon recovery tank.

1 YEAR WARRANTY

MODEL NO.	DESCRIPTION	CFM	AMPS	PATH WIDTH	WT. (LBS.)	PRICE EACH
H-10420	Carpet Extractor	90	11	18"	100	\$3,200

SHIPS VIA MOTOR FREIGHT



## PORTABLE BLOWERS

TORNADO®

Quickly dry damp floors and carpets in offices, warehouses, hotels and schools.

- Adjustable kickstand directs airflow from floor level to 90°.
- Stackable design for easy storage and portability.
- 3 speeds. 120 volts.

H-10948 With Handle – Telescopic handle and wheels for easy maneuvering.



H-10948



H-10949

ETL/C-ETL Listed

MODEL NO.	HP	CFM	AMPS	CORD	WT. (LBS.)	PRICE EACH	
						1	2+
H-10948	0.6	2200/2800/3000	4.4	20'	24	\$355	\$345

ETL/C-ETL Listed

MODEL NO.	HP	CFM	AMPS	CORD	WT. (LBS.)	PRICE EACH	
						1	2+
H-10949	0.6	2200/2800/3000	4.4	20'	21	\$325	\$315

# COMPACT AUTO FLOOR SCRUBBERS

Suck up dirty water as you scrub. Keep basement floors shiny.

- Cordless. Fold-down handles for compact storage.
- 10" non-marking polyurethane rear wheels.
- Includes two 12V AGM batteries and on-board battery charger.

## H-8041 14" SCRUBBER

- Battery provides **90 minutes** of operation.
- 4-gallon solution tank. 5-gallon recovery tank.
- Accessories: 14" soft nylon scrubbing brush and 18" squeegee assembly.

## H-9424 20" SCRUBBER

- Battery provides **120 minutes** of operation.
- 11-gallon solution tank. 12-gallon recovery tank.
- Accessories: 20" soft nylon scrubbing brush and 28" squeegee assembly.



H-8041  
14" SCRUBBER

H-9424  
20" SCRUBBER

### FLOOR SCIENCE® FLOOR CLEANER

MODEL NO.	DESCRIPTION	SIZE	PRICE EACH	
			4	8+
S-18933	Neutral Floor Cleaner	1 gal.	\$14	\$13

### FLOOR SCRUBBERS

MODEL NO.	DESCRIPTION	DIAMETER	SIZE W x L x H	RPMs	WT. (LBS.)	1 YEAR WARRANTY
						PRICE EACH
H-8041	Auto Floor Scrubber	14"	18 x 30 x 47"	200	130	\$3,195
H-9424	Auto Floor Scrubber	20"	32 x 43 x 51"	160	243	5,300

SHIPS VIA MOTOR FREIGHT

# SQUEEGEE VACUUM

Powerful suction gobbles up standing water and harsh cleaning chemicals on floors.

- Foot pedal-operated squeegee makes easy cleanup after using floor cleaning machines.
- 50' power cord and large 10" rear wheels for easy maneuvering and climbing stairs.
- Industrial 1.2 HP, 2-stage motor. High capacity 18-gallon recovery tank.



MODEL NO.	DESCRIPTION	PATH WIDTH	SIZE W x L x H	AMPS	WT. (LBS.)	1 YEAR WARRANTY
						PRICE EACH
H-9933	Squeegee Vac	24"	19 x 39 x 42"	8	60	\$1,070

Includes: Stainless steel wand, crevice tool, wet-use squeegee, dry-use squeegee and dusting brush.

SHIPS VIA MOTOR FREIGHT

# FLOOR CLEANING MACHINE

Revitalize bare floors by stripping, cleaning, buffing or polishing with this industrial cleaning machine.

- 50' power cord and adjustable handle eases operating.
- Safety lock and heavy-duty wrap-around bumper adds protection.
- Powerful 1.5 HP, 14.9 amp single speed motor.



### FLOOR CLEANING MACHINE

MODEL NO.	DESCRIPTION	DIAM.	SIZE W x L x H	RPMs	WT. (LBS.)	2 YEAR WARRANTY
						PRICE EACH
H-4702	Floor Machine	20"	22 x 20 x 46"	175	102	\$1,965

SHIPS VIA MOTOR FREIGHT

### FLOOR SCIENCE® FLOOR CLEANERS

MODEL NO.	DESCRIPTION	QTY./ BTL.	BTLs./ CASE	PRICE EACH	
				4	8+
S-18932	Stripper	1 gal.	4	\$18	\$17
S-18933	Cleaner			14	13
S-18934	Spray Buff			23	22



3M PADS – Pad driver included. Pads sold separately.

MODEL NO.	DESCRIPTION	COLOR	USE	DIAM.	QTY./ CASE	PRICE/ CASE
S-20353	7200	Black	Stripping	20"	5	\$59
S-20354	5300	Blue	Cleaning			
S-20355	5100	Red	Buffing			
S-20356	4100	White	Polishing			

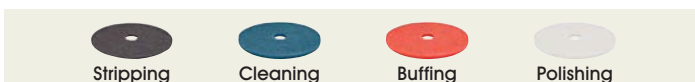

3M Pads – The industry standard for superior performance and long life.

# SHARK LIFT-AWAY® VACUUM

## ROTATOR®



Never loses suction. Powerful 10 amp motor. Use on carpets and bare floors.

- Lift-Away® canister is detachable for stairs and hard-to-reach areas.
- Lightweight and easy to maneuver swivel steering.
- Bagless. HEPA filter traps 99.97% of allergens.

Tools: 12" crevice tool, upholstery tool, dusting brush and stretch hose for hard-to-reach areas.

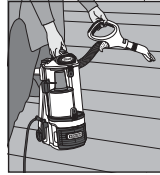

UL/C-UL Listed

MODEL NO.	CFM	AMPS	PATH WIDTH	CORD	WT. (LBS.)	PRICE EACH	
						1	2+
H-10108	125	10	9½"	25'	16	\$375	\$365

# PROFESSIONAL DUSTERS



Attract and hold dust like magnets without using chemicals!

**Professional Ostrich Feather** – For display cases, bookshelves and countertops. Non-allergenic.

**Lambswool Extension** – For tables, benches and shelves.

H-2679

\* Colors may vary

MODEL NO.	DESCRIPTION	OVERALL LENGTH	DUSTER LENGTH	QTY./CASE	PRICE EACH	
					1	12+
H-2680	Ostrich	20"	9"	12	\$17	\$15
H-2679*	Lambswool	30-45"	11"	14	14	12

# ULINE T-SHIRT RAGS

Soft and absorbent. Cotton poly blend.



- Medium-weight rags for dusting, auto work and polishing.
- Pre-washed.
- Additional rags, see page 349.

MODEL NO.	DESCRIPTION	SIZE	QTY./BOX	WT./BOX	PRICE PER BOX	
					1	4+
S-21353	Standard T-Shirt Rags	Varies	70	10 lbs.	\$35	\$34
S-18730			190	25 lbs.	77	76
S-18731			415	50 lbs.	150	148

# DEWALT® PORTABLE VACUUM



Cleans up wood chips and debris where others can't.

- Recommended for workshops.
- 5.0 HP motor. Onboard storage for cord, accessories and hose.

Accessories: 7' hose, crevice tool, 2 extension wands, 6½" utility nozzle and disposable filter bag.

DeWalt® complete line, see page 344

MODEL NO.	DESCRIPTION	GALLON CAPACITY	WT. (LBS.)	PRICE EACH	
				1	3+
H-8901	5.0 HP	4	15	\$145	\$135



# SUPPLY CABINETS

Store clothing and supplies in one cabinet.

- 1 fixed full shelf and 4 adjustable half shelves. 17" hanger rod.
- Shelves adjust in 2" increments.
- 22-24 gauge steel cabinet with 22 gauge steel shelves.
- Locking handle with 2 keys.
- Additional cabinets, see pages 504-509.

SPECIFY COLOR: Tan, Gray or Black

SHIPS UNASSEMBLED VIA MOTOR FREIGHT

MODEL NO.	DIMENSIONS W x D x H	SHELF CAPACITY	WT. (LBS.)	PRICE EACH	
				1	2+
H-2533	36 x 18 x 72"	Full – 150 lbs. Half – 75 lbs.	118	\$415	\$400

# MICROFIBER CLOTHS

New

## RUBBERMAID® HYGEN™



Disposable cloths remove 99.7% of bacteria.

- Recommended for healthcare and food services.
- Use charging bucket to store cloths or add your favorite cleaner.

MODEL NO.	DESCRIPTION	SIZE	QTY./CASE	PRICE/CASE	
				1	4+
S-25018	Microfiber Cloths	12 x 12"	600	\$140	\$130
H-10396	Charging Bucket	8 x 8 x 7"	4	34	32



# ULINE BOX OF RAGS



T-Shirt Rags



Shop Towels



Terry Cloth Towels

**Premium T-Shirt Rags** – Soft and absorbent, 100% new cotton. Heavyweight, hand sorted. No small pieces, no printing, only the best. Convenient dispenser box included.

**Shop Towels** – Reusable, launderable towels. Hemmed edges prevent unraveling.

**Terry Cloth Towels** – Top choice for cleaning and polishing. Soft and absorbent.

- S-14770 – Economical 2 oz.

\* SPECIFY COLOR: Natural or Red

MODEL NO.	DESCRIPTION	APPROX. SIZE	QTY./ BOX	WT./ BOX	PRICE PER BOX		
					1	4	12+
S-7287	Premium White T-Shirt Rags	Varies	80	10 lbs.	\$38	\$37	\$36
S-9980			220	25 lbs.	82	81	80
S-13711			440	50 lbs.	158	156	154
S-7288*	Shop Towels	14 x 14"	60	5 lbs.	28	27	26
S-13712*			350	25 lbs.	122	118	114
S-12810	Terry Cloth Towels	16 x 24"	80	25 lbs.	104	101	98
S-14770		14 x 17"	170		114	111	108

## COLORED RAGS



T-Shirt Rags

The economical choice for machine shops.

- Hides grease and oil stains.
- 100% new rags.
- Cotton poly blend.

Colors may vary

MODEL NO.	DESCRIPTION	SIZE	QTY./ BOX	WT./ BOX	PRICE PER BOX		
					1	4	12+
S-20684	Colored T-Shirts	Varies	220	25 lbs.	\$45	\$44	\$43
S-20685			440	50 lbs.	87	85	83

## HUCK TOWELS



Designed for oily, greasy or wet jobs.

- More absorbent than a shop towel.
- Streak-free cleaning on glass. Won't scratch.
- 100% new cotton.
- Machine washable.



MODEL NO.	DESCRIPTION	APPROX. SIZE	QTY./ BOX	WT./ BOX	PRICE PER BOX		
					1	4	12+
S-15734	Huck Towels	16 x 24"	170	25 lbs.	\$127	\$122	\$117

## MICROFIBER RAGS



Grab-and-go rags suggested for auto detailers, workshops and breakrooms.

- Absorbs grease and oil, traps dust and dirt.
- Seamless edges will not scratch.



SPECIFY COLOR: Blue, Yellow or Green

MODEL NO.	DESCRIPTION	SIZE	QTY./ BOX	WT./ BOX	PRICE PER BOX		
					1	4	12+
S-23351	Microfiber Rags	12 x 12"	50	2 lbs.	\$37	\$35	\$33

## BAR MOP TOWELS



Clean spills and messes in bars, kitchens and cafés.

- 100% new, 1st quality terry.
- Stripe differentiates towels. Avoid cross-contamination.



SPECIFY STRIPE COLOR: Blue or Gold

MODEL NO.	DESCRIPTION	APPROX. SIZE	QTY./ BOX	WT./ BOX	PRICE PER BOX		
					1	4	12+
S-23350	Terry Cloth	16 x 19"	130	25 lbs.	\$120	\$115	\$110

# KIMBERLY-CLARK® WIPERS



## ECONOMIZER L30

White cloth-like towels for cleaning up oil, water and grease.

- Soft enough for polishing and for use on face and hands.
- Choose between 1/4 Fold bulk pack, convenient **Dispenser Box** or a **Jumbo Roll**.

MODEL NO.	DESCRIPTION	SIZE	BASIS WT.	WIPERS PER BOX/ROLL	BOXES/ CASE	PRICE PER CASE		
						1	2	3+
S-8147	L30 1/4 Fold	12 x 12"		90	12	\$100	\$99	\$98
S-8146	L30 Dispenser Box	10 x 10"	34 lbs.	120	10	114	113	111
S-14823	L30 Dispenser Box	16 x 10"		100	8	122	120	116
S-11743	L30 Jumbo Roll	12 x 12"	34 lbs.	875	1	79	78	77



## INDUSTRIAL ALL-PURPOSE L40

This "shop towel" absorbs spills quickly. Perfect for auto repair and general maintenance.

- The best selling general purpose wiper on the market today.

**Jumbo Roll** – Perforated. Rip off the amount you need for bigger spills.

MODEL NO.	DESCRIPTION	SIZE	BASIS WT.	WIPERS PER BOX/ROLL	BOXES/ CASE	PRICE PER CASE		
						1	2	3+
S-8490	L40 1/4 Fold	12 x 12"		56	18	\$149	\$146	\$144
S-8148	L40 Dispenser Box	10 x 10"	47 lbs.	90	9	108	107	106
S-13731	L40 Dispenser Box	16 x 10"		100	9	151	150	148
S-11744	L40 Jumbo Roll	12 x 12"	47 lbs.	750	1	95	94	93



## INDUSTRIAL PLUS X60 AND X70

Reinforced for extra scrubbing and cleaning. Use for industrial surfaces and heavy tools.

**X60 Teri Wipers** – Low lint. Replaces lightweight rags.

**X70 Workhorse** – Replaces cloth rags. Designed for heavy maintenance wiping.



MODEL NO.	DESCRIPTION	SIZE	BASIS WT.	WIPERS PER BOX/ROLL	BOXES/ CASE	PRICE PER CASE		
						1	2	3+
S-14814	X60 1/4 Fold	12 x 12"		76	12	\$123	\$121	\$119
S-14815	X60 Dispenser Box	8 x 17"	36 lbs.	126	10	159	156	153
S-22785	X60 Dispenser Box	11 x 17"		252	1	48	47	46
S-11745	X60 Jumbo Roll	12 x 12"		1,100	1	157	155	153
S-14816	X70 1/4 Fold	12 x 12"		76	12	166	163	160
S-19376	X70 Dispenser Box	8 x 17"	45 lbs.	100	10	189	186	183
S-22788	X70 Dispenser Box	11 x 17"		200	1	67	66	65
S-11746	X70 Jumbo Roll	12 x 12"		870	1	165	163	161

# ULINE WIPERS

Trust in the Uline brand. Quality wipers for quick cleanups or tough scrubbing jobs.

- Available in a convenient Dispenser Box, 1/4 Fold bulk pack or perforated Jumbo Roll.

**Economy** – Soft, cloth-like wipers for light-duty cleaning. White.

**Industrial** – General purpose for cleaning and maintenance. White.

**Heavy Duty** – Sturdy enough to replace rags and shop towels for tough cleaning jobs.

\* SPECIFY COLOR: Blue, Red or White

MODEL NO.	DESCRIPTION	SIZE	BASIS WT.	WIPERS PER BOX/ROLL	BOXES/CASE	PRICE PER CASE	
						1	4+
S-18255	Economy Dispenser Box	9 x 12"	34 lbs.	120	10	\$71	\$69
S-19385	Economy Jumbo Roll	12 x 13"		950	1	62	60
S-19386	Industrial 1/4 Fold	12 x 13"	47 lbs.	56	18	92	90
S-14819	Industrial Dispenser Box	9 x 12"		90	9	68	66
S-21157	Industrial Jumbo Roll	12 x 13"		750	1	68	66
S-13630	Heavy Duty Dispenser Box	12 x 17"	70 lbs.	160	1	34	33
S-13631*	Heavy Duty Jumbo Roll	12 x 13"		475	1	66	64



## INDUSTRIAL PLUS WIPERS

Extra scrubbing power for tough cleanups.

- Reinforced, reusable wipers for HVAC technicians and mechanics.
- Absorbent, low lint and chemical resistant.

MODEL NO.	DESCRIPTION	SIZE	BASIS WT.	WIPERS PER BOX/ROLL	BOXES/CASE	PRICE PER CASE	
						1	4+
S-23352	Industrial Plus Dispenser Box	9 x 17"	42 lbs.	126	10	\$99	\$96
S-23353	Industrial Plus Jumbo Roll	12 x 13"		1,100	1	96	92



## HEAVY DUTY X80 AND X90

KIMBERLY-CLARK®

The toughest wipers on the market. Replaces shop towels.

**X80 Heavy Duty** – Use to clean heavy machinery, prep surfaces with solvents and wipe down shop tables.

**X90 Heavy Duty Plus** – Soaks up to 75% more oil than X80 wipers. Cleans up the messiest spills.

MODEL NO.	DESCRIPTION	SIZE	BASIS WT.	WIPERS PER BOX/ROLL	BOXES/CASE	PRICE PER CASE		
						1	2	3+
S-19387	X80 Dispenser Box	8 x 17"	65 lbs.	80	5	\$117	\$114	\$111
S-8150	X80 Dispenser Box	11 x 17"		160	1	57	56	55
S-8151	X80 Jumbo Roll Red	12 x 12"	65 lbs.	475	1	112	111	110
S-12862	X80 Jumbo Roll White							
S-14818	X80 Jumbo Roll Blue							
S-19388	X90 Dispenser Box	11 x 17"	60 lbs.	136	1	65	63	62
S-19389	X90 Jumbo Roll	12 x 13"		450	1	163	160	158



# KIMTECH® LOW-LINT WIPERS



Easily wipe up liquid and dust.

**Kimwipes®** – Low-lint softness safely cleans lenses, glass surfaces, electronics and lab equipment with no residue.

**Precision** – Economical choice for general low-lint cleaning in offices and labs.



S-12814



S-15811



S-18433

MODEL NO.	DESCRIPTION	SHEET SIZE	PLY	QTY./ BOX	BOXES/ CASE	PRICE PER CASE		
						1	2	3+
S-8115	Kimwipes®	4.4 x 8.4"	1	286	30	\$152	\$147	\$143
S-12814		12 x 12"	1	198	15	135	132	129
S-15811		12 x 12"	2	120	15	185	180	174
S-18431		12 x 12"	3	100	15	191	184	177
S-8116		15 x 17"	1	144	15	195	189	184
S-13736		15 x 17"	2	92	15	233	227	222
S-18432	Precision	4.4 x 8.2"	1	286	60	190	186	182
S-18433		15 x 17"	1	144	15	127	124	121

# SONTARA® WIPERS



Sucks up water, waste and solvents. Virtually lint free.

- Holds up to 4 times its weight in water. Super absorbent.
- Strong when wet or dry. Reusable.

**Uline** – Quality wipers.

**S-20681 Aerospace** – Resist snagging on metal parts and corners.



S-22747

\* White

MODEL NO.	DESCRIPTION	BRAND	SHEET SIZE	QTY./ BOX	BOXES/ CASE	PRICE PER CASE	
						1	3+
S-20678*	1/4 Fold	Sontara®	12 x 13"	50	10	\$72	\$68
S-22747	Disp. Box	Uline	9 x 17"	100	8	99	95
S-17192		Sontara®				113	109
S-20681*	Aerospace	Sontara®	9 x 17"	100	8	145	140

# WYPALL® PREP WIPES



Clean surfaces and parts before painting.

- Removes oil and grease.
- Strong. Resists most solvents.
- Feels just like cloth. Reuse many times.

MODEL NO.	DESCRIPTION	SHEET SIZE	QTY./ BOX	BOXES/ CASE	PRICE PER CASE	
					1	3+
S-14774	1/4 Fold	12 x 12"	66	8	\$122	\$117
S-13737	Disp. Box	12 x 17"	180	1	63	61
S-14773	Jumbo Roll	10 x 12"	717	1	139	135

# KIMTECH® PURE® CLEANROOM WIPES

Use in pharmaceutical and medical cleanrooms and laboratories.

- For Class 10 (ISO Class 4) or higher cleanrooms.
- Extremely low-lint wipes.



100% POLYPROPYLENE

FDA/USDA COMPLIANT

MODEL NO.	SHEET SIZE	QTY./ PACK	PACKS/ CASE	PRICE PER CASE	
				1	2+
S-13045	12 x 12"	100	5	\$200	\$195

# COLLAPSIBLE BASKET TRUCKS

Collect and transport towels and linens.

- Folds to 7" wide for easy storage in janitorial closets and utility rooms.
- Removable, washable vinyl liner won't puncture or tear.
- Lightweight, stainless steel frame.
- 3" non-marking swivel casters with bumper guards.



H-5038 – Two 4-bushel compartments for sorting.

RUBBERMAID®



MODEL NO.	OVERALL DIM. L x W x H	CAPACITY			WT. (LBS.)	PRICE EACH	
		BUSHEL	CU. FT.	LBS.		1	3+
H-5037	36 x 24 x 34"	8	10	220	28	\$190	\$185
H-5038		(2) 4	(2) 5			220	215

EASY ASSEMBLY. SHIPS VIA UPS.

## ULINE WIPERS-TO-GO® PRO

3x stronger when wet. Wring and reuse.

- Clean up after small engine repairs and equipment maintenance.
- Solvents and chemicals don't stop this wiper. Low lint.



MODEL NO.	SHEET SIZE	QTY./ BOX	WT./ BOX	PRICE PER BOX (MIN. 2)		
				2	4	8+
S-23355	9 x 13"	200	3 lbs.	\$20	\$19	\$18

## ULINE WIPERS-TO-GO®

Soft, cloth-like feel and performance at a fraction of the price!

- Absorbs spills and drips on job sites or in the shop.
- Portable. Convenient built-in handle.



Built-in handle

MODEL NO.	SHEET SIZE	QTY./ BOX	WT./ BOX	PRICE PER BOX (MIN. 2)		
				2	4	8+
S-15620	10 x 12"	200	3 lbs.	\$16	\$15	\$14

## SCOTT® RAGS-IN-A-BOX

Strong and absorbent for heavy-duty cleanup at work or home.

- Low lint. Use also for painting and refinishing.
- Pop-Up® dispenser box with built-in handle for easy portability.



Built-in handle

MODEL NO.	SHEET SIZE	QTY./ BOX	WT./ BOX	PRICE PER BOX (MIN. 2)		
				2	4	8+
S-12809	9 x 12"	200	3 lbs.	\$23	\$22	\$21

## CENTER PULL WIPERS

Closest to a cloth rag you can get.

- Disposable, economical all-purpose wipers.
- Large capacity, hands-free dispenser.
- Mount dispenser in maintenance or repair areas.



\* SPECIFY COLOR: White or Blue

MODEL NO.	SHEET SIZE	BASIS WT.	SHEETS/ ROLL	QTY./ CASE	PRICE PER CASE	
					1	2+
S-11740*	8 x 13"	47 lb.	260	4	\$80	\$78
H-2307	Wall Dispenser – 13 x 10 x 10" (HWD)				50	48



## FLOOR DISPENSER

Upscale floor dispenser used in health clubs and yoga studios to dispense sanitizing wipes.

- Stainless steel with built-in trash can for convenient wipe disposal.
- Door on back for easy emptying.
- Includes empty dispenser bucket and metal receptacle liner.

MODEL NO.	DESCRIPTION	SHEET SIZE	SHEETS/ ROLL	QTY./ CASE	PRICE PER CASE	
					1	2+
H-6368	Floor Dispenser – 36 x 13 x 13" (HWD)				\$349	\$329
S-17366	Antibacterial Wipes	8 x 6"	700	4	165	160



## ANTIBACTERIAL GYM WIPES

Wipe down sweaty treadmills and weight machines before your workout.

- Kills 99.9% of germs. Prevent salmonella and E. coli with these premoistened wipes.
- EPA registered.
- Mount dispenser in gyms, repair or maintenance areas.



MODEL NO.	DESCRIPTION	SHEET SIZE	SHEETS/ ROLL	QTY./ CASE	PRICE PER CASE	
					1	2+
S-17366	Antibacterial Wipes	8 x 6"	700	4	\$165	\$160
H-2307	Wall Dispenser – 13 x 10 x 10" (HWD)				50	48

# HAND WIPES



S-13780



S-20397



S-7718

Easy-to-use textured wet wipes help clean up in a hurry.

**Uline Tuff Wipes®** – Economical. Tough on grease, gentle on hands.

**WypAll®** – Dual texture. Wipe with one side, scrub grease and grime with the other.

**Scrubs in-a-Bucket®** – Rough texture quickly scrubs tools and surfaces clean.

## ULINE TUFF WIPES®

MODEL NO.	DESCRIPTION	SHEET SIZE	QTY./CASE	PRICE EACH		
				1	6	12+
S-13780	75 Count	9½ x 12"	6	<b>\$11 each any qty.</b>		

## WYPALL® PROSCRUB™ CLEANING WIPES

MODEL NO.	DESCRIPTION	SHEET SIZE	QTY./CASE	1	6	12+
S-20397	75 Count	9½ x 12"	6	\$23	\$22	\$21

## SCRUBS IN-A-BUCKET®

MODEL NO.	DESCRIPTION	SHEET SIZE	QTY./CASE	1	6	12+
S-7718	72 Count	10½ x 12"	6	<b>\$18 each any qty.</b>		

## ULINE SHOP TOWELS

### DISPENSER BOX

Strong, absorbent towels for auto and machine shops.

- Dispenser Box – Take it right to the cleanup area. Built-in handle for grab-and-go convenience.



MODEL NO.	TOWEL SIZE	QTY./BOX	WT./BOX	PRICE PER BOX (MIN. 2)		
				2	4	8+
S-19370	10 x 12"	200	4 lbs.	\$17	\$16	\$15

### ROLLS

Strong, absorbent towels for auto and machine shops.

- Works like cloth for your tough jobs.
- Absorbs grease and oil, even when wet.
- Fits any standard towel dispenser.



MODEL NO.	TOWEL SIZE	TOWELS/ROLL	ROLLS/CASE	PRICE PER CASE		
				1	2	3+
S-18119	9 x 11"	55	12	\$35	\$34	\$33
H-2269	Wall-Mount Towel Dispenser			\$16 ea. 3+/\$15 ea.		

## SCOTT® SHOP TOWELS

### POP-UP® BOX

Use in maintenance departments, shops or your garage.

- Pop-Up® Dispenser Box – Pull out a clean towel every time. Built-in handle.



MODEL NO.	TOWEL SIZE	QTY./BOX	WT./BOX	PRICE PER BOX (MIN. 2)		
				2	4	8+
S-15737	9 x 12"	200	4 lbs.	\$22	\$21	\$20

### ROLLS

- Absorbs liquids, oil and grease.
- Wall-Mount Towel Dispenser – Spring action holds rolls in place. Steel with white enamel finish.



**FREE** H-2269 Dispenser with order of 4+ cases of Uline or Scott® Shop Towel Rolls.

MODEL NO.	TOWEL SIZE	TOWELS/ROLL	ROLLS/CASE	PRICE PER CASE		
				1	2	3+
S-14769	9 x 11"	55	12	\$51	\$50	\$49
H-2269	Wall-Mount Towel Dispenser			\$16 ea. 3+/\$15 ea.		

## GOJO® HAND TOWELS

Easy-to-use, premoistened towels clean hands and surfaces quickly.

**Fast Towels** – Use for fast cleanups of grease, grime and oil. Smooth on both sides.

**Scrubbing Towels** – Use for heavy-duty cleaning of tar, paint and adhesives.

Dual texture. Gritty on one side, smooth on the other.



### FAST TOWELS – 2 sizes available

MODEL NO.	DESCRIPTION	SHEET SIZE	QTY./CASE	PRICE EACH		
				1	6	12+
S-11680	130 Count	9 x 10"	4	\$36	\$35	\$34
S-23223	225 Count		2	53	52	51

### SCRUBBING TOWELS

MODEL NO.	DESCRIPTION	SHEET SIZE	QTY./CASE	PRICE EACH		
				1	6	12+
S-22319	72 Count	10½ x 12"	6	\$21	\$20	\$19



# FOLDED TOWELS



## MULTI-FOLD TOWELS



## C-FOLD TOWELS

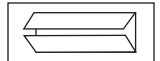

**S-13735 Uline Kraft** – Economical, absorbent towel.

**S-7127 Uline Deluxe** – Quality towels at a great price.

**S-6866 Scott®** – Strong, absorbent and soft textured weave for scrubbing.

**S-6868 Kleenex®** – Soft, thick, superior quality towel for large clean-up jobs.

**S-23403 Uline Kraft** – Dependable, affordable towels.

**S-7128 Uline Deluxe** – Tough, absorbent towels for less.

**S-6080 Scott®** – Soft textured weave for extra absorbency, scrubbing.

**S-6867 Kleenex®** – Soft on skin, industrial strength, highest quality towel.

MODEL NO.	SHEET SIZE	SHEETS/CASE	PRICE PER CASE		
			1	2	3+
S-13735	9.0 x 9.5"	4,000	\$38	\$37	\$36
S-7127	9.0 x 9.5"	4,000	\$38 per case any quantity		
S-6866	9.2 x 9.4"	4,000	76	74	71
S-6868	9.2 x 9.4"	2,400	72	70	68

MODEL NO.	SHEET SIZE	SHEETS/CASE	PRICE PER CASE		
			1	2	3+
S-23403	10 x 13"	2,400	\$42	\$41	\$40
S-7128	10 x 13"		\$41 per case any quantity		
S-6080	10.125 x 13.15"		77	75	73
S-6867	10.125 x 13.15"		94	92	89

# FOLDED TOWEL DISPENSERS



Plastic



Brushed Steel



Countertop

\* SPECIFY COLOR: White or Smoke

MODEL NO.	DESCRIPTION	DIMENSIONS H x W x D	PRICE EACH	
			1	3+
H-1133*	Plastic	19 x 13 x 6"	\$62	\$60
H-2275	Brushed Steel	15 x 11 x 5"	56	55
H-7556	Stainless Steel	16 x 11 x 4"		
H-2535	Countertop Smoke Plastic	7 x 11 x 5"	20	19

## PLASTIC

Dispenses C-Fold or Multi-Fold towels.

- 50% larger capacity than other dispensers. Holds up to 450 C-Fold or 800 Multi-Fold towels.
- Patented design dispenses one towel at a time.

## STEEL

A touch of class to brighten up your restroom.

- Attractive metal finish complements any decor.
- Holds 350 C-Fold or 550 Multi-Fold towels.

## COUNTERTOP

Economical, space-saving design.

- Sturdy high-impact plastic.
- Holds up to 300 Multi-Fold, C-Fold or specialty-fold paper towels.



# SINGLE-FOLD TOWELS AND DISPENSER

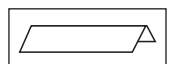

Traditionally used in schools, breakrooms and small offices.

- Dispenses one towel at a time.
- S-15744 – Soft, dependable Scott® towels.
- Heavy-duty painted steel.

MODEL NO.	BRAND	COLOR	SHEET SIZE	SHEETS/CASE	PRICE PER CASE		
					1	2	3+
S-17203	Uline	Kraft	9 x 10.7"	4,000	\$44	\$42	\$40
S-15744	Scott®	White	9 x 10.5"		87	85	82
H-2532	Dispenser 9 x 12 x 6" (H x W x D)				\$37 each	3+/\$36 each	

# TORK® BATHROOM SYSTEMS



MANUAL



AUTOMATIC



STAINLESS STEEL

European design gives your restroom a clean, stylish look.

**Manual Towel Dispenser** – Convenient, hands free.

**Automatic Towel Dispenser** – Motion activated, dispenses towel automatically. **Adjustable** sheet size, 8 to 18".

**Push Soap Dispenser** – One-hand operation. No batteries needed.

**Auto Soap Dispenser** – Touchless, sanitary dispensing.

## REFILLS

MODEL NO.	DESCRIPTION	SIZE	QTY./CASE	PRICE PER CASE	
				1	3+
S-21210	Kraft Towels	7.7" x 700'	6	\$75	\$72
S-21211	White Towels			81	78
S-21212	Foam Soap	1,000 mL	6/\$23 ea. 12+/\$21 ea.		

## PLASTIC DISPENSERS

SPECIFY COLOR: Black or White

MODEL NO.	DESCRIPTION	DIMENSIONS H x W x D	PRICE EACH	
			1	3+
H-5805	Manual Towel	15 x 13 x 8"	\$52 each	
H-5806	Automatic Towel		\$90 each	
H-5807	Push Soap	11 x 5 x 5"	\$21	\$19
H-5808	Automatic Soap		39	35

## STAINLESS STEEL DISPENSERS

MODEL NO.	DESCRIPTION	DIMENSIONS H x W x D	PRICE EACH	
			1	3+
H-7858	Push Soap	11 x 5 x 5"	\$68	\$64
H-7859	Automatic Soap		130	125

These dispensers are a leased product from Essity Professional Hygiene and are leased for the purpose of dispensing Tork® brand refills only. The use of any other brand of product in these dispensers is strictly prohibited.

## TORK® XPRESS® TOWELS



**Standard Towels** – Strong and gentle. Dry hands fast.

**Deluxe Towels** – Premium. Thick and absorbent.

**Tabletop Dispenser** – When space is an issue, this is the dispenser to use. 144 sheet capacity.



H-4450

\* SPECIFY COLOR

MODEL NO.	DESCRIPTION	SHEET SIZE	SHEETS/CASE	PRICE PER CASE		
				1	2	3+
S-24410	Standard Towels	9 x 10"	2,160	\$49	\$47	\$45
S-24411	Deluxe Towels	9 x 13"	1,504	68	66	64
H-4450*	Black or White Dispenser – 8 x 13 x 5" (HWD)			\$46 ea.	3+/\$45 ea.	
H-5995	Stainless Dispenser – 8 x 13 x 5" (HWD)			\$77 ea.	3+/\$72 ea.	

## TORK® XPRESS® WALL DISPENSER



Compact and sleek design for smaller restrooms.

- Holds 360 towels. Dispenses one towel at a time.
- Recommended for small offices, restaurants and gift shops.

Towels – Strong and gentle. Dry hands fast.

Black and White dispensers, see uline.com

MODEL NO.	DESCRIPTION	SHEET SIZE	SHEETS/CASE	PRICE PER CASE	
				1	3+
S-24410	Standard Towels	9 x 10"	2,160	\$49	\$45
H-10397	Stainless Dispenser – 18 x 12 x 4" (HWD)			\$105 each	

## TORK® PEAKSERVE® TOWELS

Slim, space-saving design for the busiest of restrooms.

- Holds 2,100 towels. Stays filled all day.
- Recommended for schools, warehouses and arenas.

Towels – Soft, strong and absorbent.

\* SPECIFY COLOR: White or Black

MODEL NO.	DESCRIPTION	SHEET SIZE	SHEETS/CASE	PRICE PER CASE	
				1	3+
S-24180	PeakServe® Towels	8 x 9"	4,920	\$100	\$95
H-9385*	Jumbo Dispenser – 29 x 15 x 4" (HWD)			\$113 each	



# ULINE FACIAL TISSUE

Attractive designer boxes for offices, breakrooms and reception areas.

**Uline** – Perfect for lobbies and offices.

**Uline Deluxe** – Premium quality, soft 2-ply tissue.

**Uline Deluxe Jumbo** – Our premium tissue in an extra-large box for fewer changeouts.

MODEL NO.	DESCRIPTION	SHEETS/BOX	BOXES/CASE	PRICE PER CASE	
				1	3+
S-7726	Uline	100	36	\$42	\$40
S-12807	Uline Deluxe			<b>\$43/case any qty.</b>	
S-21209	Uline Deluxe Jumbo	200	36	84	81



# TORK® STAINLESS DISPENSERS



Sleek, European style and quality for high-end restrooms.

- Smudge-proof stainless steel always looks clean.
- Premium roll towels. Extra soft and absorbent.

**Automatic Dispenser** – Motion activated, dispenses towel automatically. Includes 3 D batteries.

MODEL NO.	DESCRIPTION	SIZE	QTY./CASE	PRICE PER CASE	
				1	3+
S-24704	Deluxe Towels	7.7" x 900'	6	\$102	\$97
H-9952	Manual Dispenser – 16 x 14 x 8" (HWD)			\$187 each	
H-9953	Automatic Dispenser – 15 x 14 x 8" (HWD)			\$275 each	

# KLEENEX®



**Deluxe** – Aloe vera and vitamin E soothe dry, chapped skin. 2-ply.

**Covers** – High-gloss acrylic provides a clean, consistent look.



MODEL NO.	DESCRIPTION	SHEETS/BOX	BOXES/CASE	PRICE PER CASE	
				1	3+
S-6872	Kleenex®	125	48	\$131	\$127
S-6873	Kleenex® Boutique	90	36	121	117
S-23220	Kleenex® Deluxe	60	27	102	98
H-6477	Rectangle Box Cover – 2 x 9 x 5"			\$25 ea.	3+/\$24 ea.
H-6478	Boutique Box Cover – 5 x 5 x 5"			\$24 ea.	3+/\$23 ea.

# ULINE BOUTIQUE



Soft, premium 2-ply facial tissue in an attractive, space-saving cube box.

- Perfect for desks and small restrooms.

MODEL NO.	SHEETS/BOX	BOXES/CASE	PRICE PER CASE	
			1	3+
S-22356	100	36	\$59	\$56

# XLERATOR® HAND DRYERS

Fastest, most powerful dryers in the business.

- Maintenance-free, hard wired.
- Energy efficient  
12.2 amps; 110-120 volts.
- Variable speed and heat.



**THEY REALLY WORK!**

2 YEAR WARRANTY

\* SPECIFY COLOR: White or Black

MODEL NO.	DESCRIPTION	DRY TIME	DIMENSIONS H x W x D	PRICE EACH	
				1	2+
H-1927*	Specify Color	8 secs	12 x 13 x 7"	\$625	\$580
H-4529	Textured Graphite			820	775
H-3887	Stainless				



# ULINE EZ PULL DISPENSERS

## JUNIOR

Compact dispenser fits into smaller spaces.

**Dispenser** – Dispenses one sheet at a time. Translucent, easy to see when to refill.

- Sanitary, hands-free dispensing.

**Towels S-13796** – Highly absorbent. Economical.

H-10943



MODEL NO.	BRAND	COLOR	SHEETS/ROLL	SHEET SIZE	ROLLS/CASE	PRICE PER CASE		
						1	2	3+
S-13796	Uline	White	300	8 x 12"	6	\$40	\$37	\$35
H-10943	Dispenser	11 x 7 x 7"		(H x W x D)		\$25 each		

## SENIOR

Sleek design with angled dispensing. Large capacity for high-volume areas.

**Dispenser** – Dispenses one towel per pull. Patrons only touch towel they are using.

- Low maintenance, easy to refill.

**Towels S-15752** – Slightly textured, highly absorbent.

H-10944



MODEL NO.	BRAND	COLOR	SHEETS/ROLL	SHEET SIZE	ROLLS/CASE	PRICE PER CASE		
						1	2	3+
S-15752	Uline	White	600	8 x 12"	6	\$50/case any qty.		
H-10944	Dispenser	12 x 10 x 10"		(H x W x D)		\$31 each		

## CENTER PULL DISPENSER



Large capacity, sanitary, hands-free; services high-traffic areas.

**Dispenser** – Dispenses one towel per pull.

**Uline** – Highly absorbent. Economical.

**Scott®** – Soft, high quality.

**Kleenex® Towels** – Extra thick, ultra soft.

MODEL NO.	BRAND	COLOR	SHEETS/ROLL	SHEET SIZE	ROLLS/CASE	PRICE PER CASE		
						1	2	3+
S-7724	Uline	White	600	8 x 12"	6	\$50	\$49	\$48
S-7725	Scott®		500	8 x 15"	4	86	84	82
S-12851	Kleenex®		250	8 x 15"	4	132	130	128
H-1132	Dispenser	13 x 11 x 10"		(H x W x D)		\$50 each		

## PACIFIC BLUE ULTRA™ DISPENSER



Georgia-Pacific used their best technology.

**Automatic Dispenser** – Engineered not to fail. Motion activated.

- Settings for sheet length.
- Uses 4 D batteries (included).

**Pacific Blue Ultra™ Towels** – A soft, high-quality choice.

- Pacific Blue Ultra™ Dispenser will not function properly without the use of Pacific Blue Ultra™ Towels, S-17238.

MODEL NO.	BRAND	COLOR	SHEETS/ROLL	ROLL SIZE	ROLLS/CASE	PRICE PER CASE	
						1	3+
S-17238	Pacific Blue™	White	400	9" x 400'	6	\$54	\$52
H-8795	Dispenser	11 x 14 x 7"		(H x W x D)		\$71 each	

## TORK® CENTER PULL DISPENSERS



European design. Recommended for high-traffic washrooms.

**Dispenser** – Single-sheet dispensing reduces waste.

- Sanitary – Touch only the towel you use.

**Tork® Towels** – Soft, absorbent and durable.

\* SPECIFY COLOR: Black or White

MODEL NO.	BRAND	COLOR	SHEETS/ROLL	SHEET SIZE	ROLLS/CASE	PRICE PER CASE		
						1	2	3+
S-22744	Tork®	White	600	8 x 12"	6	\$66	\$64	\$61
H-7544*	Dispenser	14 x 9 x 9"		(H x W x D)		\$34 each		

These dispensers are a leased product from Essity Professional Hygiene and are leased for the purpose of dispensing Tork® brand refills only. The use of any other brand of product in these dispensers is strictly prohibited.

358 **ULINE** Order by 6 p.m. for Same Day Shipping

## JUMBO MULTI-FOLD TOWELS



H-2275

**Uline Jumbo** – 30% larger than standard multi-fold towels. 4 folds, 2-ply.



**BigFold Z®** – Extra long, thick and absorbent. 3 folds, 1-ply.



MODEL NO.	BRAND	COLOR	SHEET SIZE	SHEETS/CASE	PRICE PER CASE		
					1	2	3+
S-22310	Uline	White	9 x 13"	1,840	\$43	\$41	\$40
S-22311	BigFold Z®		10 x 11"	2,200	87	85	83
H-2275	Wall-Mount Dispenser	15 x 11 x 5"		(H x W x D)		\$56 each	

PHONE 1-800-295-5510

# ROLL TOWELS AND DISPENSER

## ROLL TOWELS

**Uline Kraft** – Dry your hands or clean up spills.

**Uline Deluxe** – White. Softer, more absorbent.

**Jumbo Roll S-13728** – 1,200 sheets. Fewer roll changes.

**Kleenex® S-12850** – Super absorbent, premium quality.

MODEL NO.	BRAND	COLOR	ROLL SIZE	SHEETS/ ROLL	ROLLS/ CASE	PRICE PER CASE	
						1	3+
S-7217	Uline	Kraft	8" x 350'	350	12	\$40/case any qty.	
S-7723		White	8" x 350'	350	12	\$49	\$45
S-12849		Kraft	8" x 800'	800	6	50	46
S-13727	White	8" x 800'	800	6	60	55	
S-13728	White	8" x 1,200'	1,200	1,200	90	83	
S-17194	Scott®	White	8" x 800'	800	12	178	172
S-12850	Kleenex®	White	8" x 600'	600	6	89	84



**DISPENSER** – Pull lever to dispense continuous supply of paper towels.

### DISPENSER

MODEL NO.	DESCRIPTION	DIMENSIONS H x W x D	PRICE EACH
H-9608	8" Manual Dispenser	14 x 12 x 9"	\$85

# HANDS-FREE DISPENSERS

## ROLL TOWELS

**Uline S-13729** – Highly absorbent. Economical. 8" wide.

**Kleenex® S-11936** – Superior quality. Soft on skin.

**Scott® S-12853** – Highly absorbent. Longer roll for fewer changes.

**Uline S-14772** – A full 10" wide. Less sheets needed to dry.

MODEL NO.	BRAND	COLOR	ROLL SIZE	SHEETS/ ROLL	ROLLS/ CASE	PRICE PER CASE	
						1	3+
S-13729	Uline		8" x 600'	600		\$48/case any qty.	
S-11936	Kleenex®	White	8" x 600'	600	6	\$95	\$93
S-12853	Scott®		8" x 950'	950		101	98
S-14772	Uline	White	10" x 800'	800	6	85	82



### DISPENSERS

Pull towel off, next one appears. No levers or push buttons.

**Kimberly-Clark® Dispenser H-2272** – Slightly different than pictured. See [uline.com](http://uline.com)

**Uline Dispenser H-2273** – Extra wide 10" rolls. Lasts longer between changes.

MODEL NO.	DESCRIPTION	DIMENSIONS H x W x D	PRICE EACH
H-2272	8" Hands-Free Dispenser	16 x 13 x 10"	\$100
H-2273	10" Hands-Free Dispenser	16 x 15 x 9"	99

# AUTOMATIC DISPENSER



## ROLL TOWELS

**Free H-7883 Dispenser with order of 4+ cases of S-11936 Towels upon request.**

**Uline S-13729** – Economical. Highly absorbent.

**Kleenex® S-11936** – Superior quality towels are soft on skin.

**Scott® S-12853** – Highly absorbent. Longer roll means fewer roll changes.

MODEL NO.	BRAND	COLOR	ROLL SIZE	SHEETS/ ROLL	ROLLS/ CASE	PRICE PER CASE	
						1	3+
S-13729	Uline		8" x 600'	600		\$48/case any qty.	
S-11936	Kleenex®	White	8" x 600'	600	6	\$95	\$93
S-12853	Scott®		8" x 950'	950		101	98



**DISPENSER** – Automatically dispenses towels one at a time.

**Electronic** – Motion-activated dispenser. Battery operated. 4 D batteries included.

### DISPENSER

SPECIFY COLOR: White or Smoke

MODEL NO.	DESCRIPTION	DIMENSIONS H x W x D	PRICE EACH
H-7883	8" Automatic Dispenser	16 x 13 x 10"	\$150

# URINAL AND TOILET FLOOR MATS



Prevent puddles caused by water or a gentleman's poor aim. • Disposable. Lasts 4-6 weeks. Nonslip bottom.

**Deluxe – Antimicrobial.** Blocks bacteria-causing odors. Maintains an upscale appearance for high-end restrooms.

**Premium – 30-day time strip** indicates when new mat is needed. **Antimicrobial.** Sophisticated style for corporate washrooms and convention centers.

SPECIFY COLOR: Gray or Black

MODEL NO.	DESCRIPTION	SIZE W x D	QTY./ CASE	PRICE PER CASE		
				1	3	6+
S-14731	Toilet	23 x 22"	6	\$65	\$63	\$61
S-14730	Urinal	17 x 20"		60	58	56

\*SPECIFY COLOR: Gray or Black

MODEL NO.	DESCRIPTION	SIZE W x D	QTY./ CASE	PRICE PER CASE		
				1	3	6+
S-21205*	Deluxe	17 x 21"	6	\$64	\$62	\$60
S-22074	Premium			75	73	71



## GRIP-TIGHT URINAL MAT

Roll out and cut to size before the team double dribbles.

- **Antimicrobial.** Blocks bacteria-causing odors. Lasts 4-6 weeks.
- Adhesive backing sticks to floor. Won't shift or roll up. Clean removal.
- Recommended for high-traffic restrooms in offices, schools and shopping malls.

MODEL NO.	DESCRIPTION	SIZE W x L	THICKNESS	PRICE PER ROLL		
				1	3	6+
S-22750	Urinal Roll	24" x 25'	1/10"	\$92	\$89	\$85

## 1-PLY TOILET TISSUE



Septic-safe tissue for RVs, boats or your outhouse.

- Soft, embossed tissue for public restrooms.
- Twice as many sheets, fewer roll changes.

MODEL NO.	SHEET SIZE	SHEETS/ ROLL	ROLLS/ CASE	PRICE PER CASE		
				1	2	3+
S-24651	4.1 x 3.5"	1,000	96	\$88	\$86	\$83

## URINAL BLOCKS AND RIM HANGERS



**Urinal Para Block – Economical odor control. Cherry scent.**

**Toilet Para Rim Hanger – Clips over rim. Cherry scent.**

**Toilet Bowl Clip – Clips under seat. 20 times more fragrant than standard rim hangers.**

MODEL NO.	DESCRIPTION	QTY./ CASE	PRICE PER CASE		
			1	3	6+
S-8129	Urinal Para Block	12	\$17	\$16	\$15
S-20081	Toilet Para Rim Hanger		24	23	22
S-23869*	Toilet Bowl Non-Para Clip		40	38	36

\*SPECIFY SCENT: Cucumber Melon, Mango or Cotton Blossom

## URINAL SCREENS

**Flat Screen – Prevents debris from clogging drains. Cherry scent.**

**Screen with Block – Maximum protection. Kills odors up to 1,200 flushes. Non-para cherry scent.**

**Deluxe Screen – 10x more fragrant than vinyl screens. Available in 5 scents.**

**Splash Hog Screen – Reduces splash-back. Available in 2 scents.**

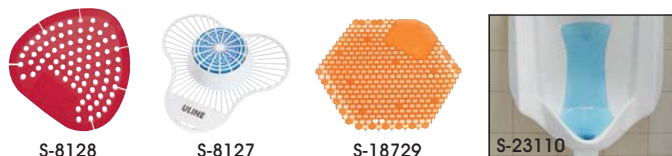

\*SPECIFY SCENT: Mango, Cucumber Melon, Lavender, Spiced Apple or Cotton Blossom

MODEL NO.	DESCRIPTION	QTY./ CASE	PRICE PER CASE		
			1	3	6+
S-8128	Flat Screen	12	\$19	\$18	\$17
S-8127	Screen with Block	12	31	29	27
S-18729*	Deluxe Screen	10	33	32	31
S-23110▲	Splash Hog Screen	6	56	54	52

▲SPECIFY SCENT: Mango or Clean



# TOILET TISSUE AND DISPENSERS

2-PLY



- S-6869 Scott® – Soft, strong, high quality.
- S-6870 Cottonelle® – Super soft tissue.
- S-23534 Charmin® – Squeezably soft®.

- S-18118 Uline Economy – Absorbent tissue at a value price.
- S-7131 Uline – High-quality tissue. 28% less than name brands.
- S-10490 Uline Deluxe – Keep the office happy.



HOLDS 2 STANDARD ROLLS

MODEL NO.	DESCRIPTION	SHEET SIZE	SHEETS/ROLL	ROLLS/CASE	PRICE PER CASE		
					1	2	3+
S-18118	Uline Economy	4.1 x 3.1"	500	96	\$65 per case any quantity		
S-7131	Uline	4.5 x 3.5"	500	96	\$77 per case any quantity		
S-10490	Uline Deluxe	4.2 x 4"	400	40	\$42 per case any quantity		
S-6869	Scott®	4 x 4"	550	80	\$132	\$130	\$127
S-6870	Cottonelle®	4.1 x 4"	451	60	117	115	112
S-23534	Charmin®	3.9 x 4"	244	24	74	72	69
H-1172	Dispenser – Black	13 x 6 x 6" (H x W x D)			\$26 each	2+/\$24 each	
H-2546	Dispenser – Steel	12 x 6 x 7" (H x W x D)			\$80 each	2+/\$75 each	

# JUMBO BATH TISSUE AND DISPENSERS

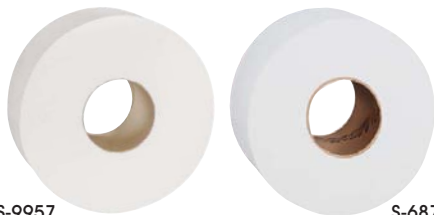

S-9957

TISSUE

S-6871



H-1127

DISPENSERS

H-1347

- S-9957 Uline – Extra long; reduces roll changes. 1-ply.
- S-6871 Uline – Strong, high-quality tissue. 2-ply.
- S-11667 Scott® – Super soft tissue. 2-ply.

Locking cover eliminates waste. Holds all brands of 9" diameter rolls.

- Double Roll Dispenser – Less maintenance, fewer roll changes.

Stainless Steel available, see [uline.com](http://uline.com)

MODEL NO.	ROLL SIZE	ROLLS/CASE	PRICE PER CASE		
			1	2	3+
S-9957	3.7" x 2,000'	12	\$63	\$61	\$59
S-6871	3.7" x 1,000'		\$51 per case any qty.		
S-11667	3.5" x 750'		124	122	119

MODEL NO.	DESCRIPTION	DIMENSIONS H x W x D	PRICE EACH	
			1	2+
H-1127	Single Dispenser	11 x 11 x 5"	\$22	\$20
H-1347	Double Dispenser	11 x 20 x 5"	38	35

# TORK® MINI JUMBO BATH TISSUE AND DISPENSERS

Bring European style and quality to your bathroom.

S-22327 Advanced – High-capacity roll for fewer changes. Non-perforated. 2-ply.

S-22328 Advanced Soft – Extra soft tissue. Perforated. 2-ply.

Dispensers – Single-roll stainless steel or double-roll plastic.



S-22328



MODEL NO.	ROLL SIZE	ROLLS/CASE	PRICE PER CASE		
			1	2	3+
S-22327	3.6" x 751'	12	\$67	\$65	\$63
S-22328			82	80	78

MODEL NO.	DESCRIPTION	DIMENSIONS H x W x D	PRICE EACH	
			1	2+
H-7177*	Plastic – Double	10 x 17 x 6"	\$30	\$28
H-9344	Stainless Steel – Single	10 x 14 x 5"	117	107

\* SPECIFY COLOR: Black or White

These dispensers are a leased product from Essity Professional Hygiene and are leased for the purpose of dispensing Tork® brand refills only. The use of any other brand of product in these dispensers is strictly prohibited.

## AIR FRESHENERS

Automatically freshens air in restrooms for round-the-clock odor control.

- One can lasts up to 180 days.
- Battery gauge and refill indicator.

**Uline** – Set to spray in 1 to 60 minute intervals.

**Rubbermaid® Microburst** – Compact size for small restrooms. Programmable with pre-set intervals.



ULINE



RUBBERMAID®

### ULINE

MODEL NO.	DESCRIPTION	CANS/CASE	PRICE PER CASE	
			1	2+
S-14824	Citrus Blossom Spray	12	\$70	\$58
S-14825	Cool Linen Spray			
S-21352	Cucumber Melon Spray			
H-2241*	Dispenser 9 x 4 x 3" (HWD)	\$39 ea.	3+/\$36 ea.	

\*Uses 2 D batteries not included. See page 636.

### RUBBERMAID®

MODEL NO.	DESCRIPTION	CANS/CASE	PRICE PER CASE	
			1	2+
S-22754	Linen Fresh Spray	12	\$115	\$110
S-22755	Mandarin Orange Spray			
S-22756	Mountain Peaks Spray			
H-7682*	Dispenser 7 x 4 x 3" (HWD)	\$90 ea.	3+/\$80 ea.	

\*Uses 2 C batteries not included. See page 636.

## TOILET SEAT COVERS/DISPENSERS



H-1592

H-878

**Covers** – Flushable, biodegradable.

**Dispenser** – Dispenses covers one at a time. Plastic or long-lasting chrome. Includes tape or mounting hardware.

\* SPECIFY COLOR: White or Smoke

MODEL NO.	DESCRIPTION	SHEETS/PACK	PACKS/CASE	PRICE PER PACK	
				6	20+
S-7276	Seat Covers	250	20	\$3.90	\$3.19
H-878*	Plastic Dispenser	11 x 16 x 3" (HWD)	2/\$20 ea.	4+/\$19 ea.	
H-1592	Chrome Dispenser	12 x 16 x 2" (HWD)	1/\$49 ea.	3+/\$47 ea.	

## KIMBERLY-CLARK® FOAMING SOAP

### AUTO DISPENSER

Soft, moisturizing foam in an easy-to-load, no-fuss dispenser.

- Cassette refills click into place.
- 2,000 applications per cartridge.
- Touch-free dispensing reduces waste and prevents the spread of germs.
- 60,000 washings between battery changes (3 D batteries included).



MODEL NO.	DESCRIPTION	SIZE	BOTTLES/CASE	PRICE PER BOTTLE	
				2	4+
S-22757	Moisturizing Foam	1,200 mL	2	\$33	\$31
S-22758	Antimicrobial Foam			45	43
H-7683	Dispenser 12 x 7 x 4" (HWD)	1,200 mL	\$37 ea.	2+/\$33 ea.	

## CORELESS BATH TISSUE AND DISPENSERS

High capacity, low maintenance. Fewer roll changes than cored rolls.

**Scott®** – Strong, soft, high quality. **S-13703 Scott®** – Super soft.

**Dispensers** – Easy, one-handed loading. Keyless.

**Standard** – Coreless rolls are 75% longer than standard cored rolls.

**Jumbo** – Extra-long rolls last longer between changes.

### KIMBERLY-CLARK®



STANDARD

JUMBO

### STANDARD

For use with H-1918 Dispenser only

MODEL NO.	DESCRIPTION	THICKNESS	SHEETS/ROLL	ROLLS/CASE	PRICE PER CASE		
					1	2	3+
S-13702	Scott®	2-ply	1,000	36	\$108	\$106	\$103
S-13703			800		110	108	106
H-1918	Dispenser 8 x 11 x 6" (HWD)				\$20 ea.	3+/\$18 ea.	

### JUMBO

For use with H-7196 Dispenser only

MODEL NO.	DESCRIPTION	THICKNESS	ROLL SIZE	ROLLS/CASE	PRICE PER CASE		
					1	2	3+
S-22346	Scott®	1-ply	3.8" x 2,300'	12	\$128	\$126	\$124
S-22347		2-ply	3.8" x 1,150'		119	116	114
H-7196	Jumbo Dispenser 10 x 14 x 6" (HWD)				\$24 ea.	3+/\$22 ea.	

# GOJO® FOAMING SOAP



## PUSH DISPENSER

Rich, creamy foam with the push of a button.

- No drips – Sinks, counters and floors stay clean.
- No batteries needed.
- 1,388 applications per cartridge.



## AUTO DISPENSER

Thick, rich foaming soap in a touchless dispenser.

- No drips – Floors and sink areas stay clean.
- 30,000 washings between battery changes.
- 1,500 applications per cartridge.



\* Uses 3 C batteries not included. See page 636.

MODEL NO.	DESCRIPTION	SIZE	BOTTLES/ CASE	PRICE PER BOTTLE	
				4	8+
S-23806	Luxury Foam			\$26	\$24
S-23807	Green Certified Foam	1,250 mL	4	29	27
S-23808	Antibacterial Foam			30	28
H-2557	Dispenser 11 x 6 x 4" (HWD)	1,250 mL		\$25 ea. 2+/\$23 ea.	

MODEL NO.	DESCRIPTION	SIZE	BOTTLES/ CASE	PRICE PER BOTTLE	
				2	4+
S-12764	All-Purpose Foam			\$40	\$37
S-17311	Green Certified Foam	1,200 mL	2	42	39
S-12765	Antibacterial Foam			43	41
H-1585*	Dispenser 10 x 6 x 4" (HWD)	1,200 mL		\$37 ea. 2+/\$34 ea.	

# GOJO® LTX™ FOAMING SOAP

Luxurious foam in a touchless dispenser. Extra large window for easy monitoring.

MODEL NO.	DESCRIPTION	SIZE	BOTTLES/ CASE	PRICE PER BOTTLE	
				2	4+
S-20716	All-Purpose Foam	1,200 mL	2	\$40	\$38
S-20717	Antibacterial Foam			43	41
H-5066	Dispenser 11 x 6 x 4" (HWD)	1,200 mL		\$35 ea. 2+/\$33 ea.	

- Uses 4 D batteries not included. See page 636.
- 1,333 applications per cartridge.



# ULINE FOAMING SOAP

Soft, cleansing foam for less. 1,333 applications per refill.

- Leakproof dispensers keep floors and counters clean.

Push Dispenser – Large window to monitor soap level. No batteries needed.

Auto Dispenser – 30,000 washings between battery changes (6 AA batteries included).

## PUSH DISPENSER

\* SPECIFY COLOR: Black or Gray

MODEL NO.	DESCRIPTION	SIZE	REFILLS/ CASE	PRICE PER REFILL	
				4	8+
S-19492	All-Purpose Foam	1,000 mL	4	\$14	\$13
S-19493	Antibacterial Foam			15	14
H-3905*	Dispenser 11 x 6 x 4" (HWD)	1,000 mL		\$15 ea. 2+/\$13 ea.	

## AUTO DISPENSER

\* SPECIFY COLOR: Black or Gray

MODEL NO.	DESCRIPTION	SIZE	REFILLS/ CASE	PRICE PER REFILL	
				2	4+
S-18233	All-Purpose Foam	1,000 mL	2	\$20	\$18
S-18234	Antibacterial Foam			21	19
H-3415*	Dispenser 10 x 7 x 7" (HWD)	1,000 mL		\$30 ea. 2+/\$28 ea.	



# ULINE BULK FOAMING SOAP/DISPENSER



Budget-wise foam. Economical choice for gas stations and public restrooms.

- H-3476 Dispenser – Large-capacity reservoir for less refills.
- 4,000 applications per bottle.
- H-3477 Pump – Attaches directly to soap bottle.

MODEL NO.	DESCRIPTION	SIZE	QTY./ CASE	PRICE PER BOTTLE	
				1	4+
S-22764*	Free and Clear Foam			\$17	\$15
S-18230*	All-Purpose Foam	1 Gal.	4	18	16
S-18231*	Antibacterial Foam			20	18
H-3476	Dispenser 8 x 5 x 4" (HWD)	46 oz.		\$29 ea. 2+/\$28 ea.	
H-3477	Pump	N/A		\$4.50 ea. 4+/\$4.00 ea.	

\* Pump sold separately



# BULK SOAP/DISPENSERS



MODEL NO.	DESCRIPTION	CAP.	PRICE PER BOTTLE	
			1	4+
S-11741▲	Softsoap® Aloe	1 gal.	\$22	\$21
S-25502▲	Softsoap® Antibacterial	50 oz.	6/\$12 ea. 12+/\$11 ea.	
H-1130	Manual Dispenser 8 x 5 x 4" (HWD)	46 oz.	\$27 ea. 2+/\$26 ea.	

MODEL NO.	DESCRIPTION	CAP.	PRICE PER BOTTLE	
			1	4+
S-17081▲	Uline Aloe	1 gal.	\$15	\$14
S-17080▲	Uline Antibacterial		17	16
H-7174*	Auto Dispenser 11 x 5 x 5" (HWD)	34 oz.	\$48 ea. 2+/\$45 ea.	

▲Works in manual and automatic dispensers

\* Uses 6 AA batteries not included. See page 636.

# HAND SOAP



SOLD IN CASE QUANTITIES

MODEL NO.	DESCRIPTION	SIZE	QTY./CASE	PRICE PER BOTTLE		
				6	12	24+
S-11742	Softsoap® Aloe	7.5 oz.	6	\$4.00	\$3.50	\$3.25
S-22079	Softsoap® Antibacterial	11.25 oz.	6	5.50	5.25	5.00
S-24950	Purell® CRT Foam	17.4 oz.	4	4/\$18 ea. 12+/\$16 ea.		

SOLD IN CASE QUANTITIES

MODEL NO.	DESCRIPTION	SIZE	QTY./CASE	PRICE PER BOTTLE		
				6	12	24+
S-20660	Uline Aloe	7.5 oz.	6	\$2.50	\$2.25	\$2.00
S-20661	Uline Antibacterial		6	2.75	2.50	2.25
S-20662	Uline Antibacterial Foam		12	N/A	3.00	2.75

# SHOWER SOAP/DISPENSER



Luxurious, spa-quality soap for corporate offices, hotels and fitness centers.

- Large capacity refill bottle.
- Made with certified organic ingredients.



MODEL NO.	DESCRIPTION	SIZE	QTY./CASE	PRICE PER CASE	
				1	2+
S-22382	Shampoo	1 gal.	4	\$105	\$100
S-22383	Conditioner				
S-22384	Body Wash				
H-7216	Triple Dispenser 10 x 13 x 4" (HWD)			\$103 ea. 2+/\$100 ea.	

# INDUSTRIAL HAND SOAP



MODEL NO.	DESCRIPTION	SIZE	QTY./CASE	PRICE PER BOTTLE		
				1	4	12+
S-7294	GOJO® Orange Smooth	1 gal.	4	\$23	\$22	\$21
S-7295	GOJO® Orange Pumice		2	23	22	21
S-19475	GOJO® Cherry Pumice			26	25	24

MODEL NO.	DESCRIPTION	SIZE	QTY./CASE	PRICE PER BOTTLE		
				1	4	12+
S-17132	Uline Tuff Scrub™	1 gal.	4	\$19	\$18	\$17
S-10498	Lava®	6 oz.	24	24/\$2.75 ea. 48+/\$2.55 ea.		

# GOJO® SOAP DISPENSERS/REFILLS

King-size dispensers for when you're up to your elbows in grease and grime.

## 2,000 mL DISPENSER

Heavy-duty bag-in-a-box dispenser with one hand push operation. Three portion control settings.

## 5,000 mL JUMBO DISPENSER

Large capacity for high-traffic areas. Three portion control settings.

1,000 Applications per cartridge



17 x 6 x 6"

2,500 Applications per cartridge



21 x 9 x 7"

### 2,000 mL PRO

MODEL NO.	DESCRIPTION	REFILLS/CASE	PRICE PER REFILL	
			2	4+
S-12816-2K	Multi Green®	4	\$30	\$28
S-20086-2K	Shower Up® Soap and Shampoo		24	22
S-17276-2K	Supro Max™		36	32
S-7293-2K	Natural Orange™ Pumice		28	26
S-19369-2K	Cherry Gel Pumice		36	32
S-7719-2K	Rich Pink™ Antibacterial		21	19
H-3043	Dispenser 17 x 6 x 6" (HWD)	\$27 ea. 2+/\$25 ea.		

### 5,000 mL PRO

MODEL NO.	DESCRIPTION	REFILLS/CASE	PRICE PER REFILL	
			2	4+
S-12816-5K	Multi Green®	2	\$61	\$59
S-20086-5K	Shower Up® Soap and Shampoo		47	45
S-17276-5K	Supro Max™		66	64
S-7293-5K	Natural Orange™ Pumice		53	50
S-19369-5K	Cherry Gel Pumice		68	66
S-7719-5K	Rich Pink™ Antibacterial		39	34
H-3044	Dispenser 21 x 9 x 7" (HWD)	\$31 ea. 2+/\$29 ea.		

### REFILLS

**Multi Green®** – Nonabrasive scrubbing particles. For light to medium dirt.  
**Shower Up®** – Spa-quality body wash/shampoo for fitness centers.  
**Supro Max™** – Removes tough or sticky soils with gentle scrubbers.

**Natural Orange™ Pumice** – Added grit cuts into dirt and grease.  
**Cherry Gel Pumice** – Gel with grit cuts through grime. Pleasant scent.  
**Rich Pink™ Antibacterial** – Antibacterial soap.

## INDUSTRIAL AIR FRESHENERS



CHUBBY TUB

Chubby Tub eliminates odors in laundry rooms and basements. Little Buddy hides in coat closets and locker rooms.

- Essential oils infused plant-based gel.
- Freshens continuously up to 60 days.
- No batteries or plug-ins required.



LITTLE BUDDY

SPECIFY SCENT: Cool & Clean or Zesty Lemon

MODEL NO.	DESCRIPTION	NET OZ.	QTY./CASE	PRICE PER CASE	
				1	2+
S-24680	Super Odor Eliminator	14 oz.	6	\$50	\$45
S-24681	Pro Odor Eliminator	64 oz.	2	70	65

## JUMBO WIPES

### PURELL® HAND SANITIZING

High-capacity dispenser with 1,200 wipes for grocery stores, hospitals and lobbies.

- Kills 99.9% of disease-causing germs.
- Textured for superior cleaning.



### ULINE DISINFECTING

Big bucket with 900 wipes means business. For schools and conference centers.

- Kills 99.9% of bacteria in 15 seconds.
- Clean and disinfect in a single step.



MODEL NO.	DESCRIPTION	SIZE	QTY./ROLL	ROLLS/CASE	PRICE PER CASE	
					1	2+
S-24670	Purell® Wipes	6 x 8"	1,200	2	\$155	\$145
H-9920	Wall Dispenser – 14 x 11 x 11" (HWD)	\$75 ea. 2+/\$70 ea.				

MODEL NO.	DESCRIPTION	SHEET SIZE	COUNT	QTY./CASE	PRICE PER CASE	
					1	2+
S-24645	Bucket	8 x 6"	900	1	\$42	\$40
S-24646	Refill			2	73	70

# TORK® OPTICORE® BATH TISSUE AND DISPENSERS



TRIPLE

Leave no tissue behind. Designed to ensure each roll is used completely before advancing to the next.

**S-24702 Universal** – Strong and absorbent. 2-ply.

**S-24703 Premium** – Extra soft, high-quality tissue. 2-ply.

**Double Dispenser** – Door slides to reveal second roll.

**Triple Dispenser** – Revolving dial twists when next roll is needed.



DOUBLE

## TISSUE

MODEL NO.	SHEET SIZE	SHEETS/ROLL	ROLLS/CASE	PRICE PER CASE		
				1	2	3+
S-24702	3.8 x 4"	865	36	\$92	\$90	\$87
S-24703		800		99	96	93

## DISPENSERS

MODEL NO.	DESCRIPTION	DIMENSIONS H x W x D	PRICE EACH	
			1	2+
H-10022	Double Dispenser	8 x 11 x 7"	\$15	\$14
H-10023	Triple Dispenser	15 x 14 x 6"	23	22

These dispensers are a leased product from Essity Professional Hygiene and are leased for the purpose of dispensing Tork® brand refills only. The use of any other brand of product in these dispensers is strictly prohibited.



## BATHROOM MIRRORS

Freshen up and look your best. Use in commercial bathrooms.

- High-quality, 1/4" thick glass. Sturdy stainless steel frame.
- Galvanized steel back plate. Theft-resistant mounting bracket included.

MODEL NO.	DESCRIPTION	DIMENSIONS W x H x D	WT. (LBS.)	PRICE EACH	
				1	2+
H-9523	Bathroom Mirror	18 x 36 x 3/4"	24	\$110	\$105
H-9524		24 x 36 x 3/4"	30	135	125

SHIPS VIA MOTOR FREIGHT

## BATHROOM SHELVES

Maximize space in utility closets and bathrooms.

- 18-gauge stainless steel. Smooth satin finish.
- Corrosion-resistant. Shelf extends 5" from wall.



MODEL NO.	DESCRIPTION	DIMENSIONS W x H x D	WT. (LBS.)	PRICE EACH	
				1	2+
H-9521	Bathroom Shelf	12 x 4 x 5"	2	\$54	\$52
H-9522		18 x 4 x 5"	3	61	59

Mounting hardware included



## TOILET BRUSH AND PLUNGER

simplehuman®

Magnetic collar secures handle for plunger and brush.

- Prevents drips and spills.
- Slim, sleek and discreet.



S-24668

SPECIFY COLOR: White or Black

MODEL NO.	DESCRIPTION	OVERALL HEIGHT	QTY./CASE	PRICE EACH	
				1	4+
S-22385	Toilet Brush and Caddy	19"	6		
S-24668	Plunger and Caddy	23"	2	\$42	\$40

## MRS. MEYER'S® HAND SOAP

A favorite with millennials. Luxurious, refreshing and nature-inspired.

- Recommended for offices, boutiques and restaurants.
- Made with essential oils, aloe vera and olive oil.



SPECIFY SCENT: Lavender, Lemon Verbena or Basil

MODEL NO.	DESCRIPTION	SIZE	QTY./CASE	PRICE PER BOTTLE	
				6	24+
S-24336	Mrs. Meyer's®	12.5 oz.	6	\$7	\$6

SOLD IN CASE QUANTITIES

## SANITARY NAPKIN RECEPTACLES



Protection you can trust with safe, sanitary disposal.

**Receptacles** – Floor standing or wall mountable.

- Conveniently empties from top or bottom.

**Liners** – Waxed paper.



H-3584

### WALL MOUNTABLE

\* Empties from top only

MODEL NO.	DESCRIPTION	DIMENSIONS H x W x D	QTY./CASE	LBS./CASE	PRICE/CASE	
					1	3+
S-15960	Liners	10 x 7 x 3"	500	7	\$43	\$41
H-2597	Plastic Receptacle	11 x 9 x 5"	1	1	29	27
H-3454*	Stainless Steel Receptacle	10 x 7 x 4"		2	60	58

### FLOOR STANDING

S-19375	Liners	8 x 7 x 8"	500	9	\$50	\$48
H-3584	Swing-Top Receptacle	12 x 9 x 9"	1	6	57	55



## PURELL® ES AUTO DISPENSER New

Popular waterless sanitizer. Thick, rich foam sanitizes and moisturizes.

- Recommended for lobbies, cafeterias and high-traffic areas.
- Includes drip tray to keep floors clean.
- Portable, freestanding station.
- Wide metal base for added stability.
- 1,000 applications per cartridge.



MODEL NO.	DESCRIPTION	SIZE	BOTTLES/CASE	PRICE PER BOTTLE	
				2	4+
S-25084	Foam Cartridge	1,200 mL	2	\$51	\$49
H-10632*	Dispenser 9 x 6 x 4" (HWD)		1,200 mL	\$30 ea. 2+/\$27 ea.	
H-10633*	Dispenser With Stand 52 x 17 x 13" (HWD)			\$310 ea. 2+/\$300 ea.	

\* Includes 4 C batteries

## PURELL® ELITE TFX™ DISPENSER

Unobtrusive, sleek high-end dispenser. Touch-free dispensing from both sides.

- Recommended for cruise ships, casinos and restaurants.
- Closed high-capacity drip tray hides overflow.
- One-piece dispenser and stand.



S-19716



S-13808



S-19716 – 1,000 applications per cartridge.

S-13808 – 1,091 applications per cartridge.

MODEL NO.	DESCRIPTION	SIZE	BOTTLES/CASE	PRICE PER BOTTLE	
				2	4+
S-19716	Gel Cartridge	1,200 mL	4	\$29	\$28
S-13808	Foam Cartridge		2	59	57
H-4786	Dispenser Stand 59 x 17 x 12" (HWD)			\$560 ea. 2+/\$545 ea.	

## PURELL® ES PUSH DISPENSER New

Manual push-button operation with no-drip metered dispenser.

- Kills 99.9% of disease-causing germs in 15 seconds.
- 857 applications per cartridge.
- ADA compliant.



MODEL NO.	DESCRIPTION	SIZE	BOTTLES/CASE	PRICE PER BOTTLE	
				2	4+
S-25090	Gel Cartridge	1,200 mL	2	\$32	\$30
H-10644	Dispenser 9 x 6 x 4" (HWD)			\$14 ea. 2+/\$13 ea.	

## PURELL® WIPES

Germ-killing power of Purell® in convenient wipes.

- Kills 99.9% of disease-causing germs.
- Textured for superior cleaning.
- Fresh citrus scent.



S-18405

MODEL NO.	DESCRIPTION	SIZE	COUNT	CANS/CASE	PRICE PER CAN	
					1	6+
S-18405	Purell® Wipes	6 x 7"	270	6	\$20	\$19

## PURELL® HAND SANITIZER

\* SPECIFY: Original or Aloe

SOLD IN CASE QUANTITIES

MODEL NO.	SIZE	BOTTLES/CASE	PRICE PER BOTTLE		
			12	24	48+
S-14839	2 oz.	24	N/A	\$3.50	\$3.25
S-15730	4 oz.	24	N/A	3.75	3.50
S-12808*	12 oz.	12	\$9.00	8.50	8.00

JUMBO PUMP

S-24952	51 oz.	4	1/\$27 ea. 4+/\$25 ea.		
---------	--------	---	------------------------	--	--

Kills 99.9% of germs within 15 seconds.

- Popular waterless sanitizer.
- Leaves hands feeling soft and refreshed.



S-14839



S-12808



S-24952

# BATH AND HAND TOWELS



Unmatched quality, hand-picked by Uline.

- Recommended for gyms, salons and hotels.
- Soft and absorbent.

**Standard** – Durable poly-cotton blend.

**Premium** – Luxurious. 100% cotton.

## STANDARD

MODEL NO.	DESCRIPTION	SIZE	WEIGHT/DOZEN	QTY./CASE	PRICE PER CASE		
					1	2	3+
S-21282	Wash Cloth	12 x 12"	1.0 lb.	48	\$55	\$53	\$51
S-20674	Hand	16 x 27"	3.0 lbs.	24	68	66	64
S-20675	Bath	24 x 50"	10.5 lbs.	12	106	104	102
S-24970	Bath Mat	20 x 30"	7.0 lbs.	12	70	68	65

## PREMIUM

S-21283	Wash Cloth	13 x 13"	1.5 lbs.	48	\$77	\$75	\$73
S-20676	Hand	16 x 30"	5.75 lbs.	24	128	123	119
S-20677	Bath	27 x 54"	17.0 lbs.	12	191	184	176
S-24971	Bath Mat	20 x 34"	10.5 lbs.	12	115	110	105

# BLACK BATH AND HAND TOWELS



Looks sharp and masks dyes, makeup and discoloration.

- Recommended for salons, spas and motels.
- Soft and luxurious.
- Absorbent 100% cotton.

Makeup Wash Cloth



MODEL NO.	DESCRIPTION	SIZE	WEIGHT/DOZEN	QTY./CASE	PRICE PER CASE		
					1	2	3+
S-23699	Wash Cloth	13 x 13"	1.5 lbs.	48	\$160	\$155	\$150
S-23393	Hand	16 x 28"	3.5 lbs.	24	157	152	146
S-23394	Bath	27 x 52"	14.0 lbs.	12	286	275	264

# BED SHEETS AND PILLOWCASES New



Fresh, quality bedding your guests will remember.

**Premium** – Luxurious 300 thread count. Soft 100% cotton. Cozy and comfortable for hotels, resorts and vacation rentals.

**Standard** – 200 thread count. 40/60 poly-cotton blend. Crisp and wrinkle-resistant for motels, clinics and nursing homes.



## PREMIUM

MODEL NO.	DESCRIPTION	SIZE	DIMENSIONS	QTY./CASE	PRICE PER CASE		
					1	2	3+
S-24972	Flat Sheet	Queen	97 x 115"	12	\$460	\$450	\$440
S-24973		King	115 x 115"		545	530	515
S-24974	Fitted Sheet	Queen	60 x 80 x 15"	12	490	480	470
S-24975		King	78 x 80 x 15"		560	545	530
S-24976	Pillowcase	Queen	21 x 31"	72	635	620	605
S-24977		King	21 x 37"		680	665	650

## STANDARD

MODEL NO.	DESCRIPTION	SIZE	DIMENSIONS	QTY./CASE	PRICE PER CASE		
					1	2	3+
S-24978	Flat Sheet	Twin XL	66 x 102"	24	\$375	\$365	\$355
S-24979		Queen	90 x 104"		225	220	215
S-24980	Fitted Sheet	Twin XL	39 x 80 x 12"	24	330	320	310
S-24981		Queen	60 x 80 x 12"		210	205	200
S-24982	Pillowcase	Standard	20 x 30"	72	235	230	225

# HOUSEKEEPING CART

Best seller. #1 choice for hotels, motels and exquisite resorts.

- Generous 18 x 30" shelves hold housekeeping supplies for up to 16 hotel rooms.
- Tough vinyl laundry bag and vacuum holder. Under-deck shelf holds glass rack.

MODEL NO.	DESCRIPTION	DIMENSIONS W x D x H	WT. (LBS.)	PRICE EACH	
				1	3+
■H-4605	Housekeeping Cart	22 x 60 x 50"	102	\$1,050	\$1,015
S-20225	Replacement Bag	11 x 17 x 33"	3	68	65

■ SHIPS VIA MOTOR FREIGHT

## RUBBERMAID®

- Corner bumpers protect walls.
- 8" non-marking wheels: 2 locking swivel, 2 rigid.



# ULINE MICROFIBER TOWELS

Miracle fabric cleans surfaces without cleaners or chemicals!

- Lint free. No need to re-wipe. • Washable. Reusable. Just rinse off and dry.

**Yellow** – Smooth, non-looped material. For streak-free glass and mirrors.

**Assorted** – Includes 4 Blue, 4 Red and 4 Green.

**Heavyweight** – Super soft and thicker. Recommended for car washes, pet groomers and food prep stations.

MODEL NO. / COLOR	SIZE	TOWELS/ PACK	WT./ PACK	PRICE PER PACK	
				1	4+
S-12812 Blue, S-17975 Red, S-12813 Green, S-12811 Yellow, S-21713 White, S-21714 Assorted	16 x 16"	12	1.5 lbs.	\$35	\$31
S-22767 Dark Blue – Heavyweight	16 x 16"	12	2 lbs.	40	36



## TEXTURED MICROFIBER TOWELS

Shimmy up all your surfaces with these microfiber towels.

**Suede** – Polishing towel for lenses, jewelry and electronics.

**Waffle Weave** – Super absorbent for soaking up spills or automotive wipe-down.

MODEL NO.	DESCRIPTION	COLOR	SIZE	TOWELS/ PACK	WT./ PACK	PRICE PER PACK	
						1	4+
S-23383	Suede	Maroon	16 x 16"	12	1 lb.	\$35	\$31
S-23384	Waffle Weave	Gray	18 x 24"	6	1.5 lbs.	39	35



## COLORED BOTTLE AND SCRUB BRUSHES

Keep brushes straight by color, one for food and the other for work surfaces.



### BOTTLE

- Strong polypropylene handle with extra-stiff polyester bristles.
- For dairy plants and bottling facilities.

### SCRUB

- Easy-grip handle with stiff polyester bristles.
- For commercial kitchens and restrooms.



SPECIFY COLOR: Black, Green, Yellow, Red, Blue or White

MODEL NO.	DESCRIPTION	SIZE W x L	PRICE EACH		
			1	3	6+
H-8558	Bottle Brush	4 x 17"	\$21	\$20	\$19

FDA COMPLIANT

SPECIFY COLOR: Black, Green, Yellow, Red or Blue

MODEL NO.	DESCRIPTION	SIZE W x L	PRICE EACH		
			1	3	6+
H-8559	Short Handle	3 x 10"	\$16	\$15	\$14
H-8560	Long Handle	3 x 16"	18	17	16

FDA COMPLIANT

## SWEEP BROOMS

**Fuller®** – Compact design. Works great on low pile carpet.

**Rubbermaid®** – Durable. For tile, hardwood and warehouse floors.

**Bissell®** – Dual rubber brushes provide outstanding, quick cleanup.



MODEL NO.	DESCRIPTION	PATH WIDTH	WT. (LBS.)	PRICE EACH	
				1	2+
H-1928	Fuller®	7"		\$53	\$50
H-1625	Rubbermaid®	7.5"	4	87	82
H-4490	Bissell®	7.5"		70	66

## COLORED DUST PANS AND BROOMS

Separate colors for kitchens, food courts, restrooms and lobbies.

- Color coding reduces the risk of cross-contamination.
- Polyester bristles and lightweight 37" aluminum handle.



SPECIFY COLOR: Black Green Yellow Red Blue

MODEL NO.	DESCRIPTION	WIDTH	PRICE EACH		
			1	3	6+
H-7854	Dust Pan/Broom Combo	14"	\$90	\$88	\$85





# JANITOR CARTS

## RUBBERMAID®

Popular, well-designed cart seems to be everywhere.

- **Large capacity:** 3 shelves, hooks and holders for all cleaning equipment.
- **Bottom shelf** easily accommodates Bucket (H-7401) or 32 gallon Brute® Container (H-1045).
- **Ease of use:** 8" non-marking rear wheels, 4" swivel wheels in front.



## RUBBERMAID®

MODEL NO.	DESCRIPTION	DIMENSIONS W x D x H	WT. (LBS.)	PRICE EACH	
				1	3+
H-1336	Standard	22 x 46 x 38"	34	\$245	\$235
S-15827	Replacement Bag	18 x 11 x 31"	1	73	68

## ULINE

Uline quality at an economical price. Glides easily across floor.

- Room for all your tools with 3 shelves, hooks and holders. Zippered vinyl bag.
- Bottom platform holds Bucket (H-7401) or 32 gallon Uline Waste Container (H-3687).
- 6" non-marking rear wheels. 3" swivel wheels in front.



High-Capacity and High-Security Carts, see [uline.com](http://uline.com)

## ULINE

MODEL NO.	DESCRIPTION	DIMENSIONS W x D x H	WT. (LBS.)	PRICE EACH	
				1	3+
H-6347	Standard	22 x 46 x 38"	34	\$185	\$180
S-21665	Replacement Bag	18 x 11 x 31"	1	44	42

# SPRAY BOTTLES



Tough plastic bottles marked with ounce and milliliter measurements.

- Standard blue nozzle included.
- Sprayers adjust from fine to steady stream.

MODEL NO.	SIZE	OUTPUT (mL)	BOTTLES/CASE	PRICE EACH (MIN. 6)	
				6	12+
S-11686	16 oz.				
S-7272	24 oz.	.9	6	\$2.35	\$2.15
S-7273	32 oz.				

# REPLACEMENT NOZZLES



Color code your cleaning solutions.

**Standard** – Adjust from fine mist to steady stream.

**Deluxe** – Over 2 times the output. Molded 3-finger comfort trigger. Won't leak, even during shipping.

SPECIFY COLOR: Red, White or Blue

MODEL NO.	DESCRIPTION	SIZE	OUTPUT (mL)	NOZZLES/PACK	PRICE EACH (MIN. 6)	
					6	12+
S-15859	Standard	16 oz.		6	\$1.45	\$1.35
S-15860		24 oz.	.9			
S-15861		32 oz.				
S-17986*	Deluxe	24 oz.	2.2	6	3.00	2.80
S-17987*		32 oz.				

\* Blue only

# 360° DUAL ACTION SPRAY BOTTLES



30% more output than standard spray bottles.

- Works at any angle – even upside down.
- Dual-action trigger sprays on the pull and release.

SPECIFY COLOR: Red, Blue or Green

MODEL NO.	SIZE	OUTPUT (mL)	BOTTLES/CASE	PRICE EACH	
				1	5+
S-24631	34 oz. (1 Liter)	1.2	25	\$24	\$22

# CHEMICAL RESISTANT SPRAY BOTTLES



Use with weed killers, pesticides and strippers.

- Super-charged nozzle sprays **three times** more than standard nozzles.
- Graduated scale for easy mixing and diluting.

MODEL NO.	DESCRIPTION	SIZE	OUTPUT (mL)	BOTTLES/CASE	PRICE EACH (MIN. 3)	
					3	6+
S-16187	Standard	32 oz.	3.0	3	\$8.50	\$8.00
S-23426	Solvent					

# WAVEBRAKE® BUCKETS/WRINGERS

Specially shaped bucket reduces splashing.



## SIDE PRESS

- Holds up to 32 oz. mop.
- 200,000 wring cycles.

H-7402 – High-capacity with foot-operated drain.



Optional bucket separates clean and dirty water. Fits under wringer.



H-7404

RUBBERMAID®



## DOWN PRESS

- Holds up to 32 oz. mop.
- 200,000 wring cycles.
- Down pressure dries out your mop better.

### SIDE PRESS

▲ SPECIFY COLOR: Red Yellow Blue

MODEL NO.	DESCRIPTION	CAPACITY	WT. (LBS.)	PRICE EACH	
				1	3+
H-7400		26 qt.	19	\$89	\$84
H-7401▲	Bucket w/ Wringer	35 qt.	20	103	98
H-7402		44 qt.	21	235	224
H-7404*	Dirty Water Bucket	18 qt.	2	33	30

\* For use with H-7401, H-7402 and H-7403 only

### DOWN PRESS

MODEL NO.	DESCRIPTION	CAPACITY	WT. (LBS.)	PRICE EACH	
				1	3+
H-7403	Bucket w/ Wringer	35 qt.	20	\$184	\$179
H-7404*	Dirty Water Bucket	18 qt.	2	33	30

\* For use with H-7401, H-7402 and H-7403 only

# WET FLOOR SIGNS



**Stand** – Durable plastic lays flat for easy storage.

**Pop-up** – Collapsible. Includes wall mount for storage.

**Cone** – 4-way visibility. • Stacks easily.

MODEL NO.	DESCRIPTION	STYLE	SIZE W x H	PRICE EACH	
				1	6+
H-868	Stand	Multilingual	11 x 25"	\$30	\$27
H-2271		English	11 x 25"	30	27
H-1931	Pop-up	Multilingual	21 x 20"	44	41
H-6474			21 x 30"	60	57
H-2838	Cone	Multilingual	12 x 36"	65	61

# HANGING SIGN

Block hallways and doorways for temporary closures.

- Adjustable pole expands 28 to 50".



MODEL NO.	DESCRIPTION	STYLE	SIGN SIZE W x H	PRICE EACH	
				1	3+
H-4508	Hanging	Multilingual	16 x 12"	\$36	\$34

English/Spanish on one side, English/French on the other

# OVER-THE-SPILL™ PADS

Soak up water and oil in kitchens, supermarkets and schools.

- Hang from your wet floor sign for easy access.
- Strong and absorbent. Each pad picks up 12 oz. of liquid.



MODEL NO.	DESCRIPTION	SIZE W x H	PADS/PACK	PACKS/CASE	PRICE PER PACK		
					1	4	12+
S-25009	Tablet	16 x 13"	22	12	\$33	\$32	\$30

# MOP/BROOM HOLDERS

Keep mops and brooms tidy.

- Spring-activated rubber clips grasp mops and brooms securely.
- White, powder-coated steel or corrosion-resistant stainless steel.

MODEL NO.	DESCRIPTION	DIMENSIONS W x D x H	NO. OF CLIPS	PRICE EACH		
				1	3	6+
H-2840	White	24 x 3 x 4"	4	\$43	\$42	\$41
H-2841	Stainless Steel			72	70	67
H-2555	White w/ Shelf	34 x 5 x 7"	6	83	80	76
H-5042	Stainless w/ Shelf			153	148	141



**With Shelf** – 4" deep with hooks for additional storage.

## VEHICLE WASH KIT



Take pride in your ride. Keep it clean and looking professional.

- Extendable 12' reach for washing semis, vans and delivery trucks.
- Soft, durable bristles scrub without scratching. Brushes easily attach to pole.

Kit Includes: Soft brush, bi-level brush, 4-12' telescoping pole and case.

MODEL NO.	DESCRIPTION	OVERALL LENGTH	BRUSH SIZE	WT. (LBS.)	PRICE EACH	
					1	3+
H-9994	Vehicle Wash Kit	12'	10"	6	\$140	\$135

## SNOW BRUSH

Keep your company's fleet free of snow and ice.

- Extendable 60" reach with pivoting brush head and foam squeegee.
- Soft brush bristles sweep snow away. Removable scraper breaks up ice.
- Lightweight aluminum handle with foam grips.



MODEL NO.	DESCRIPTION	OVERALL LENGTH	BRUSH SIZE	WT. (LBS.)	PRICE EACH	
					1	3+
H-8832	Snow Brush	60"	12"	2	\$39	\$37

## CORDLESS WET/DRY VAC



MILWAUKEE®

Portable, grab and go, toolbox sized. Wet/dry vac makes cleanup simple and easy.

- Recommended for body shops and garages.
- Uses Milwaukee® M18™ Battery and Charger, not included.
- Runs 30 minutes on a full charge.

Accessories: 6' hose, crevice tool, wide utility nozzle and HEPA filter. Easily store inside unit.

MODEL NO.	DESCRIPTION	GALLON CAPACITY	PATH WIDTH	WT. (LBS.)	PRICE EACH	
					1	2+
H-8853	Wet/Dry	2	Up to 5"	10	\$187	\$177
H-8854	M18™ High Output Battery XC8.0			2	285	275
H-8855	M18™ Rapid Charger			2	115	110

UL/C-UL Listed for commercial use

## DRIVE-THRU RECEPTACLE

Removable dome lid with chute conceals trash and keeps rain out.

- Recommended for drive-thrus and gas stations.
- Weather-resistant plastic won't rust, dent or chip.
- Use with recommended S-3528 Trash Liner, see page 393.



MODEL NO.	CAPACITY	SIZE W x D x H	WT. (LBS.)	PRICE EACH		
				1	3	6+
H-9995	45 Gallon	33 x 22 x 50"	31	\$385	\$375	\$365



30 FOOT REACH

## HIGH ACCESS CLEANING TOOLS

UNGER®

Thirty feet of cleaning reach, six tools and only one pole!

- Change light bulbs and clean every dusty corner of your warehouse or office.
- Safer and faster than using a ladder.
- Quality tools attach easily to telescopic pole.

H-7227 Combo Includes: Light Bulb Changer, Pipe Brush Duster, Lambswool Duster, Ceiling Fan Duster, Cobweb Duster and FIXI Clamp.



MODEL NO.	DESCRIPTION	PRICE EACH	
		1	6+
H-7223	Light Bulb Changer		
H-7224	Pipe Brush Duster	\$25	\$23
H-6058	Lambswool Duster	25	23
H-7225	Ceiling Fan Duster		

MODEL NO.	DESCRIPTION	PRICE EACH	
		1	6+
H-6057	Cobweb Duster	\$12	\$11
H-7226	FIXI Clamp	43	41
H-7227	Combo Cleaning Tools	\$140 each	
H-7228	8-30' Telescopic Pole	\$190 ea. 3+/\$185 ea.	



# ULINE 5S SHADOW BOARDS

Organize workspace according to 5S lean principles.

- Reduce clutter and avoid missing tools.
- Polyethylene bonded aluminum board lasts a lifetime. Easy to clean, corrosion and UV-resistant.
- Rubber grippers hold tools securely. Tool mounting hardware included.



## WET ZONE

### H-9614 KIT INCLUDES:

- Wet Mop Handle
- Wet Mop Head
- 4" Floor Scraper
- Spray Bottles (6)
- Black Scrub Brush
- Bucket/Wringer
- Dirty Water Bucket
- Wet Floor Sign

## DRY ZONE

### H-8070 KIT INCLUDES:

- Steel Dust Pan
- Standing Dust Pan
- Standard Angle Broom
- Contractor Push Broom
- Black Counter Brush



\* SPECIFY COLOR: Blue, Red or Green

MODEL NO.	DESCRIPTION	DIMENSIONS H x W	WT. (LBS.)	PRICE EACH	
				1	3+
H-9613	5S Wet Zone Shadow Board	68 x 30"	28	\$430	\$420
H-9614	5S Wet Zone Cleaning Tool Kit		31	\$205 each	

■ SHIPS VIA MOTOR FREIGHT

MODEL NO.	DESCRIPTION	DIMENSIONS H x W	WT. (LBS.)	PRICE EACH	
				1	3+
H-8043*	5S Shadow Board	68 x 30"	28	\$420	\$410
H-8070	5S Cleaning Tool Kit		15	\$82 each	

■ SHIPS VIA MOTOR FREIGHT

## ROLLING STEP STOOLS



Glides easily into place. Stays put when stepped on.

- Recommended for small storage rooms, pharmacies and retailers.
- Spring-loaded casters retract when weight is applied.
- Anti-skid rubber base.

- Powder-coated steel with slip-resistant rubber steps.

SPECIFY COLOR: ■ Black ■ Red

MODEL NO.	STEPS	TOP STEP HEIGHT	LOAD CAPACITY	BASE DIAMETER	WT. (LBS.)	PRICE EACH	
						1	2+
H-7846	2	17"	500 lbs.	17½"	12	\$62	\$59

EASY ASSEMBLY. SHIPS VIA UPS.

## MULTI-SURFACE VACUUM

Commercial-duty cleaning for offices, motels and reception areas.

- Conveniently carry attachments for carpeted, uncarpeted and hard-to-reach surfaces. 2-motor system.
- Washable HEPA filter captures 99.97% of allergens.

QUIET CLEAN®

Accessories: Telescopic wand with attached dusting brush and 9' reinforced stretch hose for hard-to-reach areas.



### SANITAIRE®

MODEL NO.	DESCRIPTION	AMPS	PATH WIDTH	CORD	WT. (LBS.)	PRICE EACH	
						1	2+
H-2268	Multi-Surface	11.5	13"	50'	20	\$515	\$495

UL/C-UL Listed

## INDUSTRIAL PUSH SWEEPER

Sweep bulky trash in warehouses and parking lots.

- Clean up to 25,000 square feet in an hour.
- Rotating broom pushes debris into cleaning path, main broom sweeps it into hopper.
- Durable plastic construction with aluminum frame. 11" wheels.



MODEL NO.	DIMENSIONS L x W x H	SWEEPING WIDTH	HOPPER CAP.	PRICE EACH	
				1	2+
H-2760	41 x 29 x 48"	26"	9 gal.	\$680	\$660

## MAGNETIC SWEEPER

Nails, tacks and metal shavings cling to powerful magnets.

- Cleans up metal debris from warehouse floors, loading docks and parking lots.
- Lever raises magnet to release debris. 1½" lift height.
- 6" rubber wheels. 150 lb. pull capacity.



MODEL NO.	DIMENSIONS L x W x H	SWEEPING WIDTH	PRICE EACH	
			1	2+
H-2617	30 x 10 x 38"	24"	\$235	\$225

# GARAGE TOOL HOLDERS



Easily hold your widest brooms, mops and shovels.

- Recommended for garages, tool sheds, landscaping facilities or your warehouse.



- Easy snap in, snap out design.
- Extra wide grippers lock in anywhere along the aluminum track.

FDA COMPLIANT. NSF CERTIFIED. SPECIFY COLOR: Black, Blue or Red

MODEL NO.	DESCRIPTION	DIMENSIONS W x D x H	NO. OF CLIPS	PRICE EACH		
				1	3	6+
H-7866	Tool Holder	21 x 4 x 2"	3	\$42	\$40	\$38
H-7867		37 x 4 x 2"	5	55	53	51

# 3M HAND PADS



S-19266

Conforms to uneven surfaces. Lasts longer than steel wool.

**General Purpose** – For final finishing or light cleaning of metal and wood.

**Heavy Duty** – For stripping varnish, deburring welds and removing rust.

MODEL NO.	DESCRIPTION	SIZE	QTY./CTN.	PRICE PER CARTON		
				1	3	6+
S-19266	7447 General Purpose	6 x 9"	20	\$34	\$33	\$32
S-21116	7440 Heavy Duty			106	102	98

# PEST CONTROL



INSECT  
S-19547



ANT  
S-15767



WASP  
S-17539



FLIES  
S-20331

MODEL NO.	DESCRIPTION	SIZE	QTY./CASE	PRICE EACH (MIN. 6)	
				6	12+
S-19547	Insect Repellent	6 oz.	12	\$10	\$9
S-15767	Ant and Roach	17.5 oz.		8	7
S-17539	Wasp and Hornet	14 oz.		9	8
S-20331	Fly Trap Bag		12	12	11

# MR. CLEAN® MAGIC ERASER®



Magically "erase" tough dirt, grime and scuff marks.

- No scouring or scratching.
- Moisten with water, no harsh chemicals.

MODEL NO.	DESCRIPTION	PAD SIZE W x L x H	PADS/CASE	PRICE PER CASE		
				1	3	5+
S-23224	Magic Eraser®	5 x 2 x 1"	36	\$59	\$57	\$54

# 3M JUMBO SPONGE



10 times more absorbent than a standard sponge.

- Cleans walls, workbenches and floors without shredding.

MODEL NO.	DESCRIPTION	SIZE W x L x H	QTY./PKG.	PRICE PER PACKAGE		
				1	3	6+
S-20186	Sponge #C31	4 x 6 x 1½"	24	\$62	\$59	\$56

# WIRE BRUSHES



Remove rust, paint and debris from aluminum, steel and other metals.

- Stiff stainless steel bristles won't rust and discolor surfaces.

MODEL NO.	DESCRIPTION	SIZE W x L	BRISTLE LENGTH	QTY./PACK	PRICE PER PACK	
					1	3+
S-20188	Curved Handle	1/2 x 7¾"	7/16"	4	\$17	\$16
S-20187		1 x 14"	1½"	2	16	15
S-20189	Shoe Handle	1½ x 10"	1½"	2	20	19

# FOLDING FACILITIES CART



A fabulous cart for moving supplies where you need them.

- Second shelf folds up to accommodate larger items.
- Strong welded frame.
- Collapsible – Sides fold in to save space when not in use.
- 6" phenolic casters: 2 swivel, 2 rigid.



SHIPS ASSEMBLED VIA MOTOR FREIGHT

MODEL NO.	DIMENSIONS L x W x H	SHELF QTY.	CAPACITY (LBS.)	WT. (LBS.)	PRICE EACH	
					1	3+
H-4577	44 x 28 x 70"	2	2,000	187	\$735	\$715

# AIR FRESHENER SPRAYS

Refresh the air with a pleasing scented spray – from freshly dried linen to the tropical breezes of Hawaii.

- For restrooms, offices, hospitals and nursing homes.

MODEL NO.	DESCRIPTION	NET OZ.	CANS/CASE	PRICE/CASE	
				1	2+
S-17146 S-17147	Uline Citrus Blossom Uline Cool Linen	16 oz.	12	\$53	\$51
S-24894 S-21454	Febreze® Linen & Sky™ Febreze® Hawaiian Aloha™	8.8 oz.	6	32	30
S-25494 S-25495	Glade® Cashmere Woods Glade® Tropical Blossoms	8.3 oz.	6	27	25

- Ready-to-spray aerosol can. Keep one nearby to neutralize odors.
- 6 different scents to suit any environment.



# SWIFFER® DUSTERS

Electrostatic charge traps dust and allergens.

- Use on wood, ceramic or any hard surface.

**Starter Kit – 1 handle, 5 dusters.**



MODEL NO.	DESC.	QTY./BOX	BOXES/CASE	PRICE/BOX	
				1	6+
H-2632	Starter Kit	1	6	\$9	\$8
S-16199	Refills	10	4	16	14

# SWIFFER® SWEEPER

Quick and easy cleanup for breakrooms and kitchens.

- Wet Cloths – Leave floors clean, shiny and residue-free. Fresh scent.
- Dry Cloths – Trap and lock dirt and dust.
- Safe for linoleum, vinyl, ceramic and hardwood floors.



MODEL NO.	DESCRIPTION	QTY./PACK	PRICE PER PACK	
			1	12+
S-13901	Wet Cloths	12	\$11	\$9
S-16029	Dry Cloths	32	16	15
H-1960	Floor Sweeper – 10" wide		\$24 ea. 3+/\$23 ea.	



# CLOROX® CLEAN-UP®

Kills viruses and bacteria in 30 seconds.

- Powerful bleach-based cleaner recommended for clinics and offices.



MODEL NO.	QTY./BOTTLE	BTL./CASE	PRICE/BOTTLE (MIN. 4)	
			4	9+
S-23909	32 oz.	9	\$10	\$9

# DISINFECTING WIPES

Clean and disinfect in one quick step.

- Kills 99.9% of bacteria and viruses on hard surfaces.

**Uline – Good. Clean. Quality.**

**Lysol® – Thick, strong wipes. Lemon Blossom scent.**



\* SPECIFY SCENT: Lemon or Fresh Scent

MODEL NO.	DESCRIPTION	SHEET SIZE	COUNT	CANS/CASE	PRICE PER CAN (MIN. 6)	
					6	12+
S-19459*	Uline	7 x 8"	75	6	\$5	\$4
S-24547	Lysol®		80		11	10

For full line of Cleaning Supplies, see pages 378-379.

# AIR WICK® PLUG-INS

Oil warmer eliminates odors and keeps room smelling fresh.

- Refills last up to 60 days.
- Fresh Waters® scent.



MODEL NO.	DESC.	QTY./CTN.	PRICE PER CARTON	
			1	2+
S-21835	Refills	12	\$52	\$50
H-6557	Warmer	6	14	13

# CONTINUOUS AIR FRESHENERS

Consistent fragrance and odor control for restrooms.

**Cartridges – One lasts up to 90 days.**

**Dispenser – 2 settings: Light for 1-2 stalls, Standard for 3-4 stalls.**

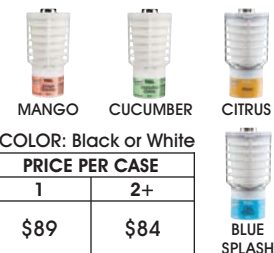

Self-powered, no batteries required

\* SPECIFY COLOR: Black or White

MODEL NO. / SCENT	QTY./CASE	PRICE PER CASE	
		1	2+
S-18741 Citrus S-18742 Blue Splash	6	\$89	\$84
S-21271 Mango S-21272 Cucumber Melon			
H-3542* Dispenser 5 x 3 x 3" (HWD)		\$17 ea. 3+/\$16 ea.	

# RUBBERMAID®





# FOAMING GLASS CLEANERS



## SPRAYWAY®

The first and still The Best. Everyone's favorite foaming glass cleaner.

- No dripping or streaking.
- Removes dirt, grease and grime.

MODEL NO.	DESCRIPTION	QTY./CAN	CANS/CASE	PRICE PER CAN (MIN. 4)		
				4	12	24+
S-21321	Sprayway®	19 oz.	12	\$5.00	\$4.75	\$4.50



## ULINE

Uline quality. Fast-acting, industrial cleaner.

- Foam clings to surface for easy cleaning.
- No dripping or streaking.
- Removes dirt, smudges and grime.

MODEL NO.	DESCRIPTION	QTY./CAN	CANS/CASE	PRICE PER CAN (MIN. 4)		
				4	12	24+
S-22344	Uline	19 oz.	12	\$4.15	\$4.00	\$3.85

## AMAZING ERASER



Wipe away smudges and dirt from floors, baseboards, walls and tile.

- No scrubbing or scouring.
- Moisten with water, no harsh chemicals necessary.

MODEL NO.	DESCRIPTION	PAD SIZE	PADS/CASE	PRICE PER CASE		
				1	3	5+
S-19311	Uline Eraser	5 x 2 x 1"	24	\$25	\$23	\$21

## ACETONE New

Strip latex paint, remove sticky resin from tools and clean ink off print presses.

- Dries quickly. Leaves no residue.
- Use on epoxies, ink, lacquers and fiberglass resins.



SOLD IN CASE QUANTITIES

MODEL NO.	DESCRIPTION	QTY./CAN	CANS/CASE	PRICE PER CAN	
				4	12+
S-25036	Klean Strip®	1 gal.	4	\$44	\$40

## GOO GONE®



Removes all the tough stuff.

- Use on latex paint, labels, caulk equipment, tools.
- S-18803 Spray Gel – Drip-free formula.

S-12787

S-18803

S-18415

\* MIN. QTY. 6

MODEL NO.	DESCRIPTION	QTY./BOTTLE	BTL./CASE	PRICE PER BOTTLE		
				1	4-6	12+
S-18415*	Liquid	8 oz.	12	N/A	\$7	\$6
S-18803	Spray Gel	12 oz.	6	\$10	9	8
S-12787	Liquid	1 gal.	4	50	48	46

## STAINLESS STEEL CLEANERS



Weiman® – #1 rated stainless steel cleaner on the market. Provides a streak-free shine on your appliances.

Sprayway® – Extra fine mist spray cleans and polishes in one step. Resists fingerprints and grease.



S-21520

\* MIN. QTY. 6

MODEL NO.	DESCRIPTION	QTY./CAN	CANS/CASE	PRICE PER CAN	
				4-6	12+
S-21520	Weiman® Wipes	30	4	\$6.65	\$6.10
S-21521*	Weiman® Spray	17 oz.	6	8.55	8.00
S-21322	Sprayway® Spray	15 oz.	12	8.25	8.00

## MOLD AND MILDEW REMOVER

### WET & FORGET®

Get rid of mold and mildew on bridges, bike trails and decks.

- Easy application. Just spray and walk away. Stains gradually disappear.
- Use with pressure sprayers and washers.



MODEL NO.	DESCRIPTION	QTY./BOTTLE	BTL./CASE	PRICE PER BOTTLE		
				1	4	12+
S-25037	Wet & Forget®	1 gal.	4	\$45	\$43	\$41

## CONCRETE CLEANER

### SIMPLE GREEN®

Removes grease, mold and tire marks from driveways, sidewalks and patios.

- Natural power of peroxide won't harm plants, pets or wildlife.
- Use with pressure sprayers and washers.



MODEL NO.	DESCRIPTION	QTY./BOTTLE	BTL./CASE	PRICE PER BOTTLE		
				1	4	12+
S-25039	Concrete Cleaner	1 gal.	4	\$24	\$23	\$22

# SIMPLE GREEN®



MODEL NO.	DESCRIPTION	SIZE	BTLs./CASE	PRICE PER BOTTLE		
				1	6	12+
S-20941	Original	24 oz.	12	N/A	\$8.10	\$7.55
S-7290		1 gal.	6	\$18	\$17 any qty.	
S-11687		5 gal.	1	85	80	75
■S-9983		55 gal.	1	609	588	567
S-23471	Lemon	24 oz.	12	N/A	8.10	7.60
S-20097		1 gal.	6	19	18	17
■S-22343		55 gal.	1	609	588	567
S-11732	Crystal Industrial Strength	1 gal.	6	23	22	21
S-11733		5 gal.	1	96	90	85
■S-11734		55 gal.	1	719	698	677
S-14771	Extreme	1 gal.	4	25	24	23
S-15856		5 gal.	1	107	102	97
■S-17244		55 gal.	1	793	772	751
S-15857	d Pro 5® Disinfectant	1 gal.	4	26	25	24
S-23473		5 gal.	1	122	117	112

The most versatile all-purpose cleaner available.

**Original** – Effective, nonflammable, biodegradable and nonabrasive formula.

**Lemon** – Original formula with lemon scent.

**Crystal** – Industrial strength, 20% more concentrated than the original formula.

**Extreme** – Heavy duty. Cuts through grease, oil and dirt. Biodegradable. Approved for aircraft use.

**d Pro 5® Disinfectant** – Hospital-grade disinfecting. For clinics, schools and food processing facilities. EPA registered.

■ SHIPS VIA MOTOR FREIGHT

## ULINE INDUSTRIAL CLEANERS

Fast-acting industrial cleaners penetrate grease and grime.

**Multi-Purpose** – Concentrated, noncorrosive, non-butyl formula. Biodegradable.

**Industrial Purple** – Highly concentrated, butyl-based formula. High alkaline.



Multi-Purpose Industrial Purple 55 Gal.

MODEL NO.	DESCRIPTION	QTY./BOTTLE	BTLs./CASE	PRICE PER BOTTLE		
				4	8	12+
S-20690	Multi-Purpose	1 gal.	4	\$14	\$13	\$12
■S-24224		55 gal.	1	\$530 ea.	4+/\$525 ea.	

SOLD IN CASE QUANTITIES

■ SHIPS VIA MOTOR FREIGHT

MODEL NO.	DESCRIPTION	QTY./BOTTLE	BTLs./CASE	PRICE PER BOTTLE		
				4	8	12+
S-20692	Industrial Purple	1 gal.	4	\$12	\$11 any qty.	
■S-24225		55 gal.	1	\$500 ea.	4+/\$495 ea.	

SOLD IN CASE QUANTITIES

■ SHIPS VIA MOTOR FREIGHT

## SANITIZING WIPES



### SANI-WIPE®

Super saturated wipes sanitize countertops fast.

- Kills 99.9% of germs in 60 seconds.
- No rinsing required.
- Approved for use on food contact surfaces.

MODEL NO.	DESCRIPTION	SHEET SIZE	QTY./CAN	CANS/CASE	PRICE/CAN (MIN. 6)	
					6	12+
S-23602	Sani-Wipe®	8 x 9"	72	12	\$8.50	\$8.00
S-21834					95	6

### SUPER SANI-CLOTH®

#1 brand of germicidal wipes in healthcare.

- Disinfects in 2 minutes.
- Kills 32 microorganisms.
- For use on hard, nonporous surfaces.



MODEL NO.	DESCRIPTION	SHEET SIZE	QTY./CAN	CANS/CASE	PRICE/CAN (MIN. 6)	
					6	12+
S-22853	Super Sani-Cloth®	6 x 7"	160	12	\$13	\$12

# ULINE CLEANING SUPPLIES



## GLASS CLEANERS

Clean and shine windows and mirrors without streaking.

**Wipers** – Use with glass cleaner for cleaning and light-duty scrubbing.

MODEL NO.	DESCRIPTION	SIZE	QTY./CASE	PRICE EACH		
				1	4	12+
S-19451	Glass Cleaner	32 oz.	12	N/A	\$4.30	\$3.50
S-19452	Glass Cleaner Refill	1 gal.	4	\$9.50	\$7.00 each	
S-19453	Glass and Surface Wipers	10 x 16"	900	\$65 cs. 2+/\$63 cs.		

# BRAND QUALITY. UNBEATABLE PRICES.



## ALL-PURPOSE CLEANERS

**Lavender** – Best seller. Pleasant lavender fragrance.

**All Purpose** – Tough on dirt and grime in tubs and sinks.

**Cleaning Vinegar** – All natural for floors and counters.

MODEL NO.	DESCRIPTION	QTY./BOTTLE	BTL./CASE	PRICE PER BOTTLE		
				1	4	12+
S-19454	Lavender	1 gal.	4	\$12.00	\$11.00	\$10.00
S-19455	All Purpose	32 oz.	12	N/A	3.75	3.25
S-25034	Cleaning Vinegar	1 gal.	4	N/A	6.00	5.50



## BATHROOM CLEANERS

Commercial strength for hospital, office and industrial use.

**Spray Cleaner** – Kills bacteria and viruses\*. Cleaner and disinfectant in one bottle.

**Toilet Bowl Cleaner** – Dissolves hard water stains and mineral deposits. Disinfects.

MODEL NO.	DESCRIPTION	QTY./BOTTLE	BTL./CASE	PRICE PER BOTTLE		
				1	4	12+
S-19373	Disinfectant	32 oz.	12	N/A	\$4.50	\$4.00
S-19374	Disinfectant Refill	1 gal.	4	\$12.25	11.00	10.50
S-24321	Toilet Bowl Cleaner	32 oz.	12	N/A	3.75	3.50

\* For complete list of bacteria and viruses, see uline.com



## LAUNDRY DETERGENTS

Heavy-duty cleaners tackle the toughest laundry needs.

- Use in both high efficiency and regular washers.

**Liquid** – Concentrated clean, fresh scent.

**Powder** – Commercial strength. Fresh lemon scent.

MODEL NO.	DESC.	SCENT	QTY./BOTTLE	BTL./CASE	SOLD IN CASE QUANTITIES PRICE PER BOTTLE		
					1	4	8+
S-19458	Liquid	Fresh	100 oz.	4	N/A	\$14	\$13
S-20687	Powder	Lemon	50 lbs.	1	\$59	\$55 each	



## BLEACH

Sanitize and disinfect.

- Brighten whites and sanitize surfaces for less.

**Clorox**® – The most trusted brand of bleach.

SOLD IN CASE QUANTITIES

MODEL NO.	DESCRIPTION	QTY./BOTTLE	BTL./CASE	PRICE PER BOTTLE		
				3	6	9+
S-19457	Bleach	1 gal.	3	\$6.50 each		
S-19719	Clorox® Bleach	121 oz.	3	\$11.25 each		

## ULINE DISH SOAP



Tough on grease, easy on your budget. For spotless pots and pans.

- Powerful, concentrated liquid.
- Cuts through stuck-on food.

SOLD IN CASE QUANTITIES

MODEL NO.	DESCRIPTION	QTY./BOTTLE	BTL./CASE	PRICE PER BOTTLE	
				4-6	12+
S-25035	Uline Liquid	40 oz.	6	\$6.50	\$6.00
S-21268		1 gal.	4	19.00	17.00



# CLEANING SUPPLIES



S-7143



S-25513



S-7146



S-24177



S-17246



S-7139



S-19513

## ALL-PURPOSE CLEANERS

MODEL NO.	DESCRIPTION	QTY./ BOTTLE	BTLs./ CASE	PRICE PER BOTTLE		
				1	3-4	12+
S-7143	Disinfectant	32 oz.	12	N/A	\$7.50	\$6.75
S-25513	Disinfectant Refill	1 gal.	4	\$21.80	21.30	20.80
S-7146	Pine-Sol® Original	60 oz.	6	9.25	9.00	8.75
S-13830	Pine-Sol® Original	144 oz.	3	20.25	19.25	18.75
S-19511	Pine-Sol® Lemon	144 oz.	3	19.25	18.25	17.75

## GLASS CLEANERS AND DISINFECTANTS

MODEL NO.	DESCRIPTION	QTY./ BOTTLE	BTLs./ CASE	PRICE PER BOTTLE		
				1	4	12+
S-22733	Windex® Foaming	20 oz.	6	N/A	\$6.25	\$5.75
S-24177	Windex® Spray	32 oz.	8	N/A	6.15	5.65
S-17246	Windex® Refill	1 gal.	4	\$15.65	14.20	13.15
S-7139	Lysol® Fresh	19 oz.	12	N/A	12.00	11.00
S-19513	Lysol® Crisp Linen	19 oz.	12	N/A	12.00	11.00



S-7147



S-10502



S-7141

## BATHROOM CLEANERS

MODEL NO.	DESCRIPTION	QTY./ BOTTLE	BTLs./ CASE	PRICE PER BOTTLE		
				1	4	12+
S-7147	409® Disinfectant	32 oz.	12	N/A	\$6.75	\$5.75
S-10502	409® Disinfectant Refill	1 gal.	4	\$18.25	17.00	16.25
S-7141	Toilet Bowl Cleaner	32 oz.	12	N/A	6.25	5.50



S-19514



S-20941



S-18398



S-15763

## GENERAL-PURPOSE CLEANERS

MODEL NO.	DESCRIPTION	QTY./ BOTTLE	BTLs./ CASE	PRICE PER BOTTLE		
				1	4-6	12+
S-19514	Pledge®	14 oz.	6	N/A	\$8.50	\$8.00
S-20941	Simple Green® Original	24 oz.	12	N/A	8.10	7.55
S-18398	Fabuloso® Ocean Cool	1 gal.	4	\$20.00	18.00	17.00
S-15763	Fabuloso® Lavender	1 gal.	4	\$20.00	18.00	17.00



S-23211



S-9975



S-25019

Trigger Sprayer  
for Pots and Pans



S-14764

## DISH SOAPS

MODEL NO.	DESCRIPTION	SIZE	QTY./ CASE	PRICE PER BOTTLE		
				4	6-8	12+
S-23211	Cascade® ActionPacs™	25 loads	5	5/\$11 ea.	10+/\$10 ea.	
S-9975	Dawn® Liquid	38 oz.	8	\$9.50	\$9.00	\$8.75
S-14764		1 gal.	4	29.50	28.00	26.00
S-25019	Dawn® Powerwash™	16 oz.	6	N/A	8.00	7.50



S-19515



S-24828



S-22318



S-25518

## LAUNDRY DETERGENTS

MODEL NO.	DESCRIPTION	SIZE	QTY./ CASE	PRICE PER BOTTLE		
				2	4	8+
S-19515	Tide® HE Liquid	92 oz.		\$28	\$27	\$25
S-24828	Tide® HE Pods®	81 ct.	4	37	35	33
S-25518	OxiClean™ HE Powder	7 lbs.		29	27	26
S-22318	Bounce® Dryer Sheets	160 ct.	6	6/\$16 ea.	12+/\$15 ea.	



## ANGLE BROOMS

Grab dirt from hard-to-reach spots.

**Standard** – Long-lasting polypropylene bristles. Hang-up handle.

**Deluxe** – Extra wide for larger areas. PET bristles. Metal handle with comfort grip.

H-5877

MODEL NO.	DESCRIPTION	WIDTH	PRICE EACH	
			1	3+
H-1957	Standard	12"	\$14	\$13
H-5877	Deluxe	15"	19	18

## SPONGE MOP

Quick cleanup in kitchens and breakrooms.

- Super-absorbent cellulose sponge head soaks up liquids and dirt.
- Durable, steel construction.
- Handle-mounted lever wrings out dirty water. Hands stay dry.



RUBBERMAID®

MODEL NO.	DESCRIPTION	WIDTH	PRICE EACH	
			1	3+
H-5879	Sponge Mop	12"	\$41	\$40
S-21320	Replacement Sponge		21	20



## COLORED DUST PANS

Won't bend or break. Strong, one-piece polypropylene construction.

- Sharp edge catches the smallest particles, leaving floors spotless.
- Color coding reduces the risk of cross-contamination.

REMCO

SPECIFY COLOR: Black, Yellow, Orange, Green, Red or Blue FDA COMPLIANT

MODEL NO.	DESCRIPTION	WIDTH	PRICE EACH	
			1	3+
H-5878	Colored Plastic Dust Pan	12"	\$18	\$17

## UTILITY BUCKETS

Heavy-duty construction.

- Spill-free pour spout and molded-in graduation marks.
- Corrosion-resistant handle with comfortable plastic grip.



RUBBERMAID®

SPECIFY COLOR: Gray or Red

FDA COMPLIANT

MODEL NO.	DIMENSIONS DIAMETER x H	CAPACITY	PRICE EACH	
			1	6+
H-2863	10½ x 10¼"	10 quart	\$13	\$12
H-2864	12 x 11¼"	14 quart	17	16

## PAPER TOWELS



EASY-SIZE™

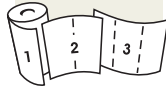

Use only what you need with 6" perforated sheets.

- Thick, 2-ply sheets for your messiest spills.

**Bounty® Select-A-Size** – The most absorbent towel on the market.

**Uline Deluxe Easy-Size™** – Long-lasting jumbo roll.

**BOUNTY® SELECT-A-SIZE**

MODEL NO.	SHEET SIZE	SHEETS/ROLL	ROLLS/PACK	PRICE PER PACK		
				1	2	3+
S-25369	11 x 6"	90	12	\$48	\$47	\$46

**ULINE DELUXE EASY-SIZE™**

MODEL NO.	SHEET SIZE	SHEETS/ROLL	ROLLS/CASE	PRICE PER CASE		
				1	2	3+
S-22309	11 x 6"	140	12	\$34	\$33	\$32

## CROCODILE CLOTH®



ORIGINAL



POWER SCRUB

25% larger. Oversized, premoistened clean-up cloths from "Down Under."

**Original** – Attack stubborn stains, dirt and grime on tools, machinery and equipment.

**Auto** – Specially formulated to cut through tough oil and grease on fleet vehicles and rental cars.

**Power Scrub** – Dual texture. Rough side removes dried-on gunk. Smooth side soaks up spills.

MODEL NO.	DESCRIPTION	SHEET SIZE	SHEETS/PACK	PACKS/CASE	PRICE PER PACK	
					1	6+
S-25023	Original		100		\$25	\$24
S-25024	Automotive	10 x 15"	100	6	25	24
S-25025	Power Scrub		80		27	26

# PAPER TOWELS

## S-7132 Scott®

- Soft, absorbent towel with textured weave cleans longer without falling apart. 1-ply.

## S-23228 Bounty®

- Absolutely the most absorbent towel on the market today. 2-ply.

## S-7711 Uline

- An absorbent towel at an economical price. 2-ply.

## S-10353 Uline Deluxe

- Super absorbent. Messiest spills clean up quickly. 2-ply.



S-7132

S-23228

S-7711

S-10353

### SCOTT® AND BOUNTY® PAPER TOWELS

MODEL NO.	SHEETS/ROLL	ROLLS/CASE	PRICE PER CASE		
			1	2	3+
S-7132	128	20	\$71	\$70	\$68
S-23228	58	24	120	115	110

### ULINE PAPER TOWELS

MODEL NO.	SHEETS/ROLL	ROLLS/CASE	PRICE PER CASE		
			1	2	3+
S-7711	85	30	\$42 per case any qty.		
S-10353	72	24	\$57 per case any qty.		

# 3M SCOTCH-BRITE™



## SCOURING PADS

Scrub kitchen sinks, walls and maintenance equipment.

**Heavy-Duty** – Easily remove burnt-on food and other tough messes.

MODEL NO.	DESCRIPTION	SIZE	QTY./CTN.	PRICE PER CARTON		
				1	3	6+
S-11724	Gen. Purpose Pads #96	6 x 9"	20	\$22	\$21	\$20
S-18434	Heavy Duty Pads #86		12	34	33	32

## SCRUBBING SPONGE

Combines a scouring pad and an absorbent sponge.

- Green for scrubbing. Yellow for spills.
- Works great on walls, tables, floors.



MODEL NO.	DESCRIPTION	SIZE	QTY./CTN.	PRICE PER CARTON		
				1	3	6+
S-11725	Scrubbing Sponge #74	3½ x 6"	20	\$72	\$70	\$67

# CLOROX® WIPES



S-11681

S-15766

## DISINFECTING WIPES

One-step cleaning and disinfecting.

- Kills 99.9% of bacteria on hard surfaces. Bleach free.

MODEL NO.	DESCRIPTION	SHEET SIZE	COUNT	CANS/CASE	PRICE PER CAN (MIN. 6)	
					6	12+
S-11681	Lemon Fresh	7 x 8"	35	12	\$5.75	\$5.00
S-11682	Fresh					
S-15765	Lemon Fresh	7 x 8"	75	6	10.50	9.00
S-15766	Fresh					

## JUMBO BUCKET

Big bucket wipes out germs.

- An essential for cafeterias, health clubs and day cares.



REFILLABLE

MODEL NO.	DESCRIPTION	SHEET SIZE	COUNT	QTY./CASE	PRICE PER CASE	
					1	2+
S-20959	Bucket – Fresh	7 x 7"	700	1	\$63	\$61
S-20960	Refill – Fresh				2	103



# ULINE HAND SANITIZER

Foaming Hand Sanitizer, see uline.com

Economical and effective. Kills 99.9% of germs in 15 seconds.

- Enriched with moisturizers for soft, smooth hands.
- Waterless alternative to soap and water.

■ SHIPS VIA MOTOR FREIGHT

MODEL NO.	DESCRIPTION	SIZE	BOTTLES/CASE	PRICE PER BOTTLE		
				12	24	48+
S-21262	Travel	2 oz.	24	N/A	\$1.55	\$1.45
S-20117	Pump	8 oz.	12	\$4.30	4.05	3.55
S-20118	Jumbo Pump	68 oz.	4	1/\$22 ea. 4+/\$20 ea.		
S-23797	Gallon	1 gal.	4	1/\$38 ea. 4+/\$35 ea.		
■ S-23798	Drum	55 gal.	1	\$1,660 each		



# ULINE PAPER PLATES



Buy in bulk with Uline.

- Grease-resistant, microwavable coated plate.

**Heavyweight – Super tough. Cut resistant.**

MODEL NO.	SIZE	DESCRIPTION	QTY./BOX	PRICE PER BOX	
				1	3+
S-18497	7"	Medium Plate	250	\$24	\$23
S-17274	9"		330	37	35
S-18498	9"	Heavyweight Plate	250	37	35
S-18499	10 1/4"			49	47
S-22797	12 oz.	Heavyweight Bowl	250	32	30
S-18500	20 oz.			36	34

# DIXIE® PAPER PLATES

Patented design for superior strength.

- Microwavable. Grease resistant.

**Heavyweight – Cut resistant.**



MODEL NO.	SIZE	DESCRIPTION	QTY./PACK	PRICE PER PACK	
				1	8+
S-19698	6"	Heavyweight Plate	250	\$23	\$22
S-12189	9"	Medium Plate	125	20	19
S-7307	9"	Heavyweight Plate		28	27
S-16318	10 1/4"			38	36
S-13804	12 oz.	Heavyweight Bowl		22	21

# ULINE SIGNATURE PLATES AND CUPS

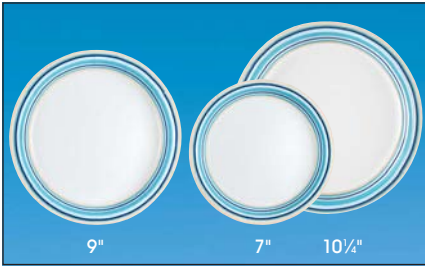

Classic style, Uline quality. Brighten up your breakroom!

**Heavyweight Plates – Grease and cut resistant. Microwavable.**

**Paper Cold Cups – Poly coated inside and out to prevent leaking.**



MODEL NO.	SIZE	DESCRIPTION	QTY./CASE	PRICE PER CASE	
				1	3+
S-20152	7"	Heavyweight Plate	250	\$30	\$28
S-20153	9"	Heavyweight Plate	250	40	38
S-22381	10 1/4"	Heavyweight Plate	250	53	51

MODEL NO.	SIZE	DESCRIPTION	QTY./CASE	PRICE PER CASE	
				1	3+
S-20154	5 oz.	Cold Cup	2,500	\$162	\$152
S-22427	9 oz.			184	174
S-20155	12 oz.	Cold Cup	1,000	85	81
S-20156	16 oz.			113	108
S-22798	32 oz.	Cold Cup	500	107	102

# YETI® MUG



Rugged design for sipping at work or under the stars.

- Double-wall insulated stainless steel. Dishwasher safe.
- Clear, shatter-resistant sip lid. Convenient handle.

MODEL NO.	DESCRIPTION	SIZE	PRICE EACH	Free with a Uline order of
S-23299	YETI® Mug	14 oz.	\$40	\$750+

# CONE PAPER CUPS



Economical paper cups for workplace water coolers.

## DISPENSER

Convenient. Use anywhere – On water coolers, near fountains or on picnic coolers.

- Includes bracket for mounting.



MODEL NO.	SIZE	DESCRIPTION	QTY./PACK	PRICE PER PACK	
				2	25+
S-9978	4 oz.	Cone Cups	200	\$7.00	\$5.50
S-17897	6 oz.			12.00	9.50

MODEL NO.	SIZE W x H	DESCRIPTION	PRICE EACH	
			1	2+
H-1352	3 x 16"	4 oz. Dispenser	\$32	\$30
H-3196	4 x 16"	6 oz. Dispenser	47	45

# COLD CUPS

## TRANSLUCENT CUPS

Smart economical choice when volume matters. Sturdy, shatterproof.

MODEL NO.	SIZE	DESCRIPTION	QTY./CASE	PRICE PER CASE	
				1	4+
S-21471	5 oz.	Translucent	2,500	\$108	\$102
S-21472	7 oz.			159	151
S-22541	10 oz.			204	196
S-25512	12 oz.	Translucent	1,000	96	91
S-25106	16 oz.			126	121

- Double sidewall ridges for extra strength.
- Smooth rolled rim for drinking comfort.



## ULINE CRYSTAL CLEAR PLASTIC CUPS

MODEL NO.	SIZE	DESCRIPTION	QTY./CASE	PRICE PER CASE	
				1	4+
S-22273	9 oz. Squat	Clear	1,000	\$77	\$72
S-22274	10 oz.	Clear	1,000	77	72
S-22275	12 oz.			83	77
S-22276	16 oz.			94	88
S-22277	20 oz.			99	94
S-22775	24 oz.			600	77
S-25045	32 oz.	Clear	300	75	70

Top quality, Uline value.

- Strong, ultra-clear virgin plastic.
- Flat, Dome and Strawless Lids, see [uline.com](http://uline.com)



## PLASTIC CUPS

Dixie® Crystal Clear – Virgin plastic. Stronger, higher end for your nice occasions.

MODEL NO.	SIZE	DESCRIPTION	QTY./CASE	PRICE PER CASE	
				1	4+
S-20144	9 oz. Squat	Clear	1,000	\$179	\$168
S-11689	10 oz.	Clear	500	95	89
S-15750	12 oz.			105	98
S-11690	16 oz.			112	105
S-23481	20 oz.	Clear	1,000	250	235
S-24514	16 oz.	Red or Blue		160	150

Uline Party Cups – Large 16 oz. for everyday use or for any party.



## PORTION CUPS



Practice portion control.

- Plastic cups for sauces and dressings.
- Paper Portion Cups, see [uline.com](http://uline.com)

### LIDS

MODEL NO.	SIZE	QTY./CTN.	PRICE/CARTON		MODEL NO.	QTY./CTN.	PRICE/CARTON
			1	3+			
S-20778	1 oz.	2,500	\$54	\$50	S-20779	2,500	\$45
S-20149	2 oz.		84	80	S-20151		65
S-21201	4 oz.	2,500	146	140	S-21202	2,500	75
S-25048	5½ oz.		230	220			

## DOUBLE-WALL PAPER CUPS

Double-wall insulation keeps drinks hot and hands cool.

- Sturdy feel, superior performance.
- White lids for on-the-go.



MODEL NO.	SIZE	DESCRIPTION	QTY./CASE	PRICE PER CASE	
				1	3+
S-21465	8 oz.	Globe Design or White	728	\$158	\$146
S-20111	12 oz.		600	147	136
S-20112	16 oz.		384	105	96
S-20114	12-16 oz.	White Lid	1,000	80	73

## IGLOO® ICE CHESTS

Keeps ice up to 4 days in 90°F heat.

MODEL NO.	SIZE (QTS.)	DESCRIPTION	HOLDS	PRICE EACH	
				1	2+
H-7735	52	Standard	85 Cans	\$65	\$62
H-7737	110	Glide	168 Cans	200	190

52 Quart – Swing-up handles.

110 Quart – Big, 6" wheels. Horizontal telescoping handle.



# ULINE GOURMET COFFEES

Start every day with a warm gourmet beverage of your choice.

Mug Gift Set includes: 5 bags of coffee, tea or cocoa; plus a Uline ceramic mug. Each coffee bag makes a full pot.

**FREE MUG GIFT SET**  
Upon request with any order of \$250 or more.

MODEL NO.	DESCRIPTION	PRICE EACH
S-5677	Coffee and Mug	\$20
S-5678	Tea and Mug	
S-5679	Cocoa and Mug	

HAVE A CUP ON US!



## COFFEE CONTAINERS



S-19165



S-24892



S-25040



S-14826

Big chubby tubs of joe for coffee-fueled offices.

- Maxwell House® – "Good to the last drop."
- Folgers® – Rich, smooth taste.
- Dunkin'® – America runs on it.
- Uline Gourmet – A customer favorite.

MODEL NO.	DESCRIPTION	BREWS (CUPS)	SIZE (OZ.)	PRICE EACH	
				1	3+
S-19165	Maxwell House® Regular	240	30.5	\$18	\$17
S-24892	Folgers® Regular Classic Roast	240	25.9	22	21
S-25040	Dunkin'® Original Roast	100	30	35	33
S-14826	Uline Gourmet	192	24	17	16

## WRAPPED CUPS



**ULINE RIPPLE –**  
Just a fantastic cup!

Individually wrapped for hotels, offices and your events.

- Plastic wrapper over each cup prevents cross-contamination.

MODEL NO.	SIZE	QTY./CASE	PRICE PER CASE	
			1	3+
S-25041	10 oz.	500	\$90	\$85

## SINGLE-SERVE COFFEE CUPS

Convenient gourmet coffee, one cup at a time.

- Use with Keurig® K-Cup and single-serve coffee brewers.



For Storage Drawer, see [uline.com](http://uline.com)



**Variety Pack –** Something for everyone. Light, medium and dark roast.

MODEL NO.	DESCRIPTION	MODEL NO.	DESCRIPTION	MODEL NO.	DESCRIPTION	QTY./BOX	BOXES/CASE	PRICE PER BOX	
								4	8+
S-20089	Breakfast Blend	S-20090	Dark Roast	S-21989	Hot Cocoa	24	4	\$15	\$14
S-21192	Donut Lover's	S-21194	French Roast	S-21451	Green Tea				
S-21193	Coastal Blend	S-20091	French Vanilla	S-21450	English Breakfast Tea				
S-22360	Colombian	S-21988	Hazelnut	S-21986	Decaf Coffee				
S-22753	100 Cup Variety Pack – Breakfast Blend, Donut Lover's, Colombian, Dark Roast								

SOLD IN CASE QUANTITIES

## ULINE PREMIUM COFFEE

Better than anything from Seattle.

- Exclusive, perfectly roasted medium dark blend.
- Use with Keurig® K-Cup and single-serve coffee brewers.

**FREE OFFER**  
Free Travel Mug with 4+ boxes of Uline Premium Coffee.



MINIMUM 4 BOXES

MODEL NO.	DESCRIPTION	QTY./BOX	BOXES/CASE	PRICE PER BOX	
				4	8+
S-22358	Medium Dark Roast	12	27	\$12	\$11





# HOT CUPS

## FOAM

Use a fresh, clean cup every time.

- Insulated white styrofoam.
- Holds ice cold and boiling hot liquids.

MODEL NO.	SIZE	QTY./CASE	PRICE PER CASE		
			1	3	5+
S-15745	6 oz.	1,000	\$73	\$70	\$66
S-6859	8 oz.		86	81	78
S-14775	10 oz.		97	93	89
S-6860	12 oz.		115	110	105
S-6861	16 oz.	500	135	129	123
S-13802	20 oz.		164	158	152



## ULINE PAPER

A breakroom necessity. Attractive and affordable.

- Coated paper keeps drinks hot.
- White lids for on-the-go.



SPECIFY COLOR: Stripe Design or White

MODEL NO.	DESCRIPTION	SIZE	QTY./CASE	PRICE PER CASE	
				1	3+
S-25080	White	4 oz.	1,000	\$74	\$71
S-25081		6 oz.		78	75
S-20104	Specify Color	8 oz.	1,000	85	82
S-20105		10 oz.		94	90
S-20106		12 oz.		114	109
S-20107	White Lid	16 oz.	1,000	135	129
S-20108		8 oz.		59	57
S-20109		10-16 oz.		1,200	78



## SOLO® PAPER

Coated paper cups keep drinks hot.

- Black lids for on-the-go.
- Hot cup sleeves keep hands cool. No more "double-cupping."



### CUPS/LIDS

MODEL NO.	DESCRIPTION	SIZE	QTY./CASE	PRICE PER CASE	
				1	3+
S-17195	Bistro Design	8 oz.	1,000	\$111	\$103
S-17196		12 oz.		141	126
S-18442		16 oz.		160	146
S-17197	Black Lid	8 oz.	1,000	95	88
S-17198		12-16 oz.		115	104

### SLEEVES

MODEL NO.	DESCRIPTION	SIZE L x W	QTY./CASE	PRICE PER CASE	
				1	3+
S-18443	Fits 12-20 oz. cups	5 x 2 1/2"	500	\$40	\$37



# INSULATED CUPS

## ULINE RIPPLE

Insulating ripple design provides a secure, easy grip.

- Keeps drinks hot and hands cool.
- White lids for on-the-go.



SPECIFY COLOR: Kraft White Black

MODEL NO.	DESCRIPTION	SIZE	QTY./CASE	PRICE PER CASE	
				1	3+
S-20260	Specify Color	8 oz.	500	\$76	\$72
S-20261		12 oz.		85	81
S-20562		16 oz.		99	94
S-20262	White Lid	8 oz.	1,000	68	63
S-20263		12-16 oz.		74	68



It's all about the gription. Just a fantastic cup!



## PERFECTOUCH®

Unique heat barrier eliminates need for beverage sleeves and "double-cupping."

- Insulated. Protects hands from steaming hot or ice cold beverages.
- Comfortable, nonslip surface.
- Use PerfectTouch® lids for drinks on-the-go.



MODEL NO.	DESCRIPTION	SIZE	QTY./CASE	PRICE PER CASE	
				1	3+
S-12962	PerfectTouch® Cup	8 oz.	500	\$105	\$95
S-15746		10 oz.		117	107
S-12963		12 oz.		131	119
S-14777		16 oz.		145	131
S-22081		20 oz.		162	145
S-13039	White Lid	8 oz.	1,000	99	88
S-17191		10-20 oz.		500	60



# COFFEE SUPPLIES



MODEL NO.	DESCRIPTION	QTY./ BOX	PRICE PER BOX	
			1	3+
S-21354	N'Joy® Creamer 12 oz.	3	\$9.50	\$9.00
S-20092	French Vanilla 15 oz.	1	8.00	7.50
S-22854	Hazelnut 15 oz.	1	8.00	7.50
S-20093	Coffee-Mate Original 22 oz.	1	9.25	8.75
S-24672	Creamer Packets	1,000	86.00	83.00
S-21356	Filters (8-10 Cup) Non-Ind.	1,000	17.50	16.50
S-9979	Filters (12 Cup) Industrial	1,000	19.00	18.50

MODEL NO.	DESCRIPTION	QTY./ BOX	PRICE PER BOX	
			1	3+
S-21355	N'Joy® Sugar 20 oz.	3	\$9.50	\$9.00
S-7296	Sweet'N Low® Packets	100	4.45	4.20
S-13906	Splenda® Packets	100	10.00	9.50
S-21357	Sugar in the Raw Packets	200	15.25	14.25
S-24164	Sugar Packets	1,000	23.00	22.00
S-7298	Plastic Stirrers 5"	1,000	4.30	4.00
S-14829	Wooden Stirrers 7½"	500	8.50	8.00

## CONDIMENT ORGANIZERS

Tidy up all your coffee essentials with multi-compartment organizers.

- Sturdy plastic won't crack, fade or chip. Industrial.
- Removable dividers create larger compartments.



9 COMPARTMENT

MODEL NO.	DESCRIPTION	SIZE W x D x H	PRICE EACH	
			1	3+
H-5922	6 Compartment	6 x 8 x 18"	\$65	\$60
H-5923	9 Compartment	15 x 12 x 15"	99	94



6 COMPARTMENT

## SLANTED CUP DISPENSERS

Easy loaders. Keep beverage stations stocked and counters organized.

- Fits cups or lids up to 4" wide.
  - Tiered design frees up counter space.
- 3 Tier – Sturdy wire iron frame.**
- 4 Tier – Sleek black polystyrene.**



H-10723



H-4761

MODEL NO.	DESCRIPTION	SIZE W x D x H	PRICE EACH	
			1	2+
H-4761	3 Tier Wire Rack	5 x 12 x 15"	\$105	\$100
H-10723	4 Tier Dispenser	5 x 21 x 21"	130	125

## MINI TRASH CAN

Spiffy little waste basket keeps your counters clean.

- Swing-top lid.
- Rustproof plastic lining.



Free upon request with any order of \$250 or more.

MODEL NO.	SIZE W x D x H	PRICE EACH		
		1	3	6+
H-3488	5 x 5 x 7½"	\$34	\$32	\$30

## BREAKROOM CABINET

Provides storage and style to office breakrooms.

- Durable laminate countertop resists scratches and stains. 3" backsplash contains spills.
- Adjustable inner shelf and slow-close drawer.
- Mahogany base and rustic slate top.



SHIPS UNASSEMBLED VIA MOTOR FREIGHT

MODEL NO.	DIMENSIONS W x D	COUNTER HEIGHT	WT. (LBS.)	PRICE EACH	
				1	2+
H-7876	36 x 25"	36"	152	\$995	\$970

## MICROWAVE

PANASONIC®

Heat up your Hot Pockets®.

- 6 power levels.
- Touch control keypad.
- 0.8 cubic ft. capacity.



UL Listed. 1 Year Warranty.

SHIPS VIA UPS

MODEL NO.	DIMENSIONS W x D x H	WATTS	PRICE EACH
H-10724	20 x 17 x 12"	1,000	\$385

# ULINE PLASTIC UTENSILS



Ideal for use in lunch or breakrooms.

**Standard Weight** – Sturdy plastic won't break with normal use.

**Heavyweight** – 50% heavier. Larger, better quality.

**4-in-1 Kit** – Wrapped set. Great for take-out dinners.

**Individually Wrapped** – Standard weight. Handy for single servings.

**Combo Kit** – Includes 60 each of forks, knives and spoons.

## STANDARD WEIGHT

MODEL NO.	DESCRIPTION	COLOR	QTY./ BOX	PRICE PER BOX	
				1	5+
S-7303	Fork	White	100	\$6	\$5
S-7304	Knife				
S-7305	Spoon				
S-7303B	Fork – Bulk Pack	White	1,000	38	35
S-7304B	Knife – Bulk Pack				
S-7305B	Spoon – Bulk Pack				
S-14752	4-in-1 Kit (Fork, Knife, Spoon, Napkin)	White	250	40	38

## INDIVIDUALLY WRAPPED STANDARD WEIGHT

MODEL NO.	DESCRIPTION	COLOR	QTY./ BOX	PRICE PER BOX	
				1	5+
S-18494	Fork – Bulk Pack	White	1,000	\$50	\$46
S-18495	Knife – Bulk Pack				
S-18496	Spoon – Bulk Pack				

## HEAVYWEIGHT

S-15783	Fork – Bulk Pack	White, Black or Clear	1,000	\$54	\$49
S-15784	Knife – Bulk Pack				
S-15785	Spoon – Bulk Pack				
S-11691	Combo Kit	Clear	180	14	13



## ROLLED CUTLERY CATERWRAP®

Convenient, pre-rolled set for catering, corporate lunches and special events.

- Heavyweight black plastic utensils.
- Soft, linen-like napkins. 17 x 17".

MODEL NO.	DESCRIPTION	COLOR	QTY./ BOX	PRICE PER BOX	
				1	5+
S-24897	4-in-1 Kit (Fork, Knife, Spoon, Napkin)	Black	100	\$120	\$110

## UTENSIL DISPENSER

Grab-and-go convenience.

- Holds 350 individually wrapped utensils.
- Refills easily with top-loading design.



MODEL NO.	DESCRIPTION	SIZE W x D x H	PRICE EACH	
			1	3+
H-7877	Utensil Dispenser	9 x 12 x 17"	\$95	\$90

## STAINLESS STEEL FLATWARE New

Nickel content provides high shine. Long-lasting durability. Withstands endless dishwashing.

MODEL NO.	DESCRIPTION	FINISH	QTY./ BOX	PRICE PER BOX	
				1	3+
S-25149	6" Teaspoon	Mirror	12	\$45	\$43
S-25150	7" Dinner Spoon			83	80
S-25151	7" Dinner Fork			83	80
S-25152	9" Euro Fork			90	87
S-25153	10" Dinner Knife			140	135

- From cafés to country clubs.
- Highest quality 18/10 stainless steel.
- Dishwasher safe.



ONEIDA®



## TOUCHLESS UTENSIL DISPENSER

Touch only what you take. One-at-a-time dispensing for schools, hospital cafeterias and coffee shops.

MODEL NO.	DESCRIPTION	COLOR	QTY./ BOX	PRICE PER BOX	
				1	5+
S-25154	Fork Refill	Black	960	\$60	\$56
S-25155	Knife Refill				
S-25156	Spoon Refill				
H-10734	Dispenser 27 x 13 x 13" (HWD)			\$145 ea.	2+/\$140 ea.

- Holds 360 individual utensils – 3 towers of 120 each.
- Easy to load. Black, standard weight refills sold separately.



CUTLEREASE™





## TAKE-OUT CONTAINERS

Leave no leftovers behind or take dinner to go.

- Microwavable and dishwasher safe.
- Sturdy, cut-resistant polypropylene.
- Available in two-piece or hinged design.



### TWO-PIECE

MODEL NO.	CAPACITY	DIMENSIONS L x W x H	QTY./CTN.	FDA COMPLIANT PRICE PER CARTON	
				1	3+
S-20512	16 oz.	9 x 6 x 1"	250	\$70	\$65
S-20513	24 oz.	9 x 6 x 1½"		85	80
S-20514	32 oz.	9 x 6 x 2"		90	85
S-20515	9 x 6 x 1" Polypropylene Lid			65	63

Lids sold separately

### ONE-PIECE HINGED

MODEL NO.	CAPACITY	DIMENSIONS L x W x H	QTY./CTN.	FDA COMPLIANT PRICE PER CARTON	
				1	3+
S-25049	18 oz.	6 x 6 x 3"	420	\$160	\$155
S-25050	39 oz.	9 x 9 x 3"	120	97	94
S-25051*	40 oz.	11 x 10 x 3"	100	88	85

\* 3 compartment



## HINGED CONTAINERS

Convenient one-piece hinged design.

- Use for sandwiches, salads or desserts.
- Snap-tight dual locks with easy grip tabs.

MODEL NO.	CAPACITY	DIMENSIONS L x W x H	QTY./CTN.	FDA COMPLIANT PRICE PER CARTON	
				1	3+
S-22911	14 oz.	5 x 5 x 3"	500	\$105	\$102
S-22912	20 oz.	6 x 6 x 3"	500	125	120
S-22913	46 oz.	8 x 8 x 3"	250	105	100
S-22914	55 oz.	9 x 9 x 3"	200	115	110
S-25052*	33 oz.	8 x 8 x 3"	250	150	145

\* 3 compartment



## TAMPER-EVIDENT CONTAINERS

Tamperproof hinged lid must be torn to open.

- For grab-and-go foods in delis and convenience stores.
- Leak-resistant lid seals tight.

MODEL NO.	CAPACITY	DIMENSIONS L x W x H	QTY./CTN.	FDA COMPLIANT PRICE PER CARTON	
				1	3+
S-25053	12 oz.	6 x 5 x 2"	200	\$56	\$53
S-25054	16 oz.	6 x 5 x 3"		58	55
S-25055	24 oz.	7 x 7 x 2"		84	79
S-25056	32 oz.	7 x 7 x 3"		90	85



## TAKE-OUT BOXES

Popular kraft paper containers for take-out dinners.

- Leak and grease-resistant inner coating. Vents steam.
- Microwavable.

MODEL NO.	CAPACITY	DIMENSIONS L x W x H	QTY./CTN.	FDA COMPLIANT PRICE PER CARTON	
				1	3+
S-22405	26 oz.	4¾ x 3½ x 2½"	450	\$134	\$129
S-22406	66 oz.	7¾ x 5½ x 2½"	200	98	95
S-22407	96 oz.	7¾ x 5½ x 3½"	160	96	93

## FOOD TRAYS

Serve up hot dogs and fries at concession stands and fairs.

- Traditional red-check pattern.
- Coated, grease-resistant paperboard.

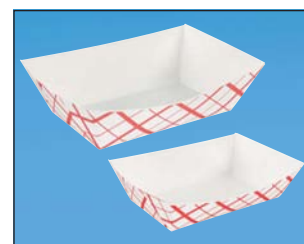

MODEL NO.	CAPACITY	TOP DIMENSIONS L x W x H	QTY./CTN.	FDA COMPLIANT PRICE PER CARTON	
				1	3+
S-22772	1 lb.	5½ x 4¼ x 1½"	1,000	\$56	\$54
S-22773	2 lbs.	6½ x 4¾ x 1½"	1,000	65	63
S-22774	3 lbs.	7¾ x 5¾ x 2"	500	52	50



## PIZZA BOXES

Keeps pizza hot and ready for customer pickup or delivery.

- 1-piece box with kraft interior. White exterior.
- Ships flat. Sets up in seconds. Tab locking.

MODEL NO.	DESCRIPTION	INSIDE DIMENSIONS W x D x H	QTY./BNDL.	FDA COMPLIANT PRICE PER BUNDLE	
				1	2+
S-17592		12 x 12 x 2"	50	\$39	\$37
S-17593	Plain White	14 x 14 x 2"		48	45
S-17594		16 x 16 x 2"		52	48

# PAPER FOOD CONTAINERS

## PLASTIC LIDS

MODEL NO.	CAPACITY	QTY./CTN.	PRICE/CARTON		MODEL NO.	PRICE/CARTON	
			1	3+		1	3+
S-25092	6 oz.	1,000	\$110	\$105	S-21362	\$114	\$110
S-21358	8 oz.		115	110			
S-21359	12 oz.	1,000	140	135	S-21363	116	112
S-21360	16 oz.	500	85	82	S-21364	160	154
S-25093	24 oz.		105	100			
S-21361	32 oz.		120	115			

1,000 LIDS/CARTON



Hot or cold. Serve soup, salads, pasta and ice cream.

- Poly coated inside and out to prevent leaks.

## DELI CONTAINERS



Popular containers for hot sides and cold salads.

- Microwavable polypropylene. Lightweight and durable.
- Handles temperatures from 32° to 230°F.
- Lids sold separately.

FDA AND USDA COMPLIANT

MODEL NO.	CAPACITY	DIMENSIONS DIAM. x H	QTY./CTN.	PRICE PER CARTON	
				1	3+
S-24984	8 oz.	4½ x 1¾"	500	\$38	\$36
S-24986	16 oz.	4½ x 3"		50	48
S-24987	32 oz.	4½ x 5½"		79	75
S-24988	4½" Polypropylene Lid		500	22	20

## HEAVY-DUTY DELI CONTAINERS

From freezer to microwave in one extra-strong container.

- Heavyweight polypropylene. Dishwasher safe.
- Handles temperatures from 0° to 250°F.
- Leak-resistant lids included.



FDA AND USDA COMPLIANT

MODEL NO.	CAPACITY	DIMENSIONS DIAM. x H	QTY./CTN.	PRICE PER CARTON	
				1	3+
S-22768	8 oz.	4½ x 1¾"	240	\$58	\$55
S-22769	12 oz.	4½ x 2½"		61	58
S-22770	16 oz.	4½ x 3"		64	61
S-22771	32 oz.	4½ x 5½"		99	95

## ALUMINUM STEAM TABLE PANS

Heavy-duty pan. Increased strength and holding power.

- Holds your heaviest casseroles. No double-panning required.

FDA AND KOSHER COMPLIANT

MODEL NO.	DESC.	GAUGE	OUTSIDE DIM. L x W x D	QTY./CTN.	PRICE/CARTON		MODEL NO.	QTY./CTN.	PRICE/CARTON
					1	3+			
S-22408	1/2 Size	40	13 x 10 x 3"	100	\$74	\$70	S-22410	100	\$50
S-22409	Full Size	70	21 x 13 x 3"	50	110	105	S-22411	50	55

Take-Out Containers, see uline.com



## FOOD SERVICE FILM



S-20199



S-20200

Jumbo-size rolls for food service, restaurants, catering and concessions.

- Seals freshness in. FDA approved.
- Dispenser box with built-in blade.

REYNOLDS

MODEL NO.	SIZE	LBS./ROLL	PRICE PER ROLL		
			1	3	5+
S-20199	12" x 2,000'	7	\$40	\$38	\$36
S-20200	18" x 2,000'	10	52	50	48

## ALUMINUM FOIL



S-20197

Preserve foods and protect against contamination. FDA approved.

- Easy to dispense, easy to tear with attached cutter blade.

Heavy Duty – Stands up to heat, cold and heavy items.

Pre-cut Sheets, see uline.com

MODEL NO.	DESCRIPTION	SIZE	LBS./ROLL	PRICE PER ROLL		
				1	3	5+
S-20197	Standard	12" x 1,000'	10	\$69	\$67	\$65
S-20198		18" x 1,000'	14	100	98	96
S-22909	Heavy Duty	18" x 500'	10	84	80	78
S-22910		24" x 500'	13	123	120	117



STAND

## TORK® XPRESSNAP®

Tork® quality and style. Innovative design dispenses one napkin at a time.

- Message panels for your promotions.

**Napkins** – Extra-large 9 x 13" size.



TABLETOP

**Tabletop Dispenser** – Top opening. Holds 250 napkins.

**Stand Dispenser** – Holds 1,000 napkins. 3x more than other holders.

### NAPKINS

MODEL NO.	DESCRIPTION	SIZE	QTY./PACK	PACKS/CASE	PRICE PER CASE	
					1	3+
S-18504	Kraft	9 x 13"	500	12	\$92	\$89
S-18505	White				95	92

### DISPENSERS

\* SPECIFY COLOR:  Black  Red

MODEL NO.	DESCRIPTION	DIMENSIONS H x W x D	NAPKIN CAPACITY	PRICE EACH	
				1	3+
H-4580*	Tabletop	6 x 8 x 6"	250	\$17	\$16
H-4581	Stand	25 x 9 x 9"	1,000	25	24

## NAPKINS AND WET WIPES

\* Individually Wrapped

MODEL NO.	DESCRIPTION	SIZE	QTY./PACK	PACKS/CASE	PRICE PER CASE	
					1	3+
S-21304	Beverage	9 x 9"	500	8	\$33	\$32
S-24967	Luncheon	12 x 12"	250	12	40	38
S-15754	Dinner	15 x 16"	250	12	158	153
S-18826*	Moist Towelettes	5 x 8"	1,000/case		45	43

## BEVERAGE DISPENSERS New

Serve piping-hot coffee or ice-cold lemonade.

**Insulated** – Keeps drinks hot or chilled for 4 hours.

- Drip-proof spigot and airtight lid.

**Uninsulated** – Elegant presentation, serves water ice cold or with a hint of flavor.

- Drip tray catches spills, keeps counters clean.



CAL-MIL



CAMBRO®

### CAMBRO® INSULATED

Dishwasher safe. NSF Listed.

MODEL NO.	DESCRIPTION	CAPACITY	SIZE H x W x D	PRICE EACH	
				1	3+
H-10638	Small	2½ Gallon	18 x 17 x 9"	\$185	\$175
H-10639	Large	4¾ Gallon	24 x 17 x 9"	210	200

### CAL-MIL UNINSULATED

MODEL NO.	DESCRIPTION	CAPACITY	SIZE H x W x D	PRICE EACH	
				1	3+
H-10640	Ice Chamber	3 Gallon	24 x 10 x 8"	\$285	\$275
H-10641	Infusion Chamber				

## FABRIC TABLECLOTHS AND NAPKINS



Dress up tables at restaurants and catered events.

- 100% spun polyester feels as soft as cotton.
- Wrinkle resistant. Won't snag, pill or lint.
- Machine washable with excellent stain release.
- Fitted Table Covers, see uline.com

Fabric Napkins

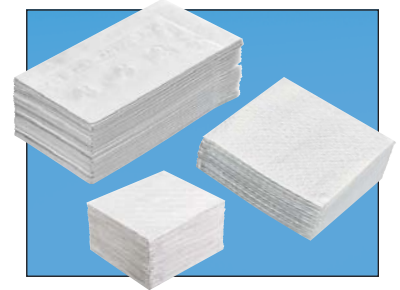

SOLD IN CARTON QUANTITIES

SPECIFY COLOR: White or Black

MODEL NO.	DIMENSIONS L x W	SHAPE	FITS TABLE	QTY./CTN.	PRICE EACH	
					12	24+
S-21305	96 x 52"	Rectangle	72 x 30"	12	\$21	\$20
S-21306	120 x 52"		96 x 30"		26	25
S-21307*	90" Diam.	Round	60" Diam.	12	36	34
S-22357	Fabric Napkins		20 x 20"	24/pack	\$44 pk. 3+/\$42 pk.	

\* White only

## STRETCH FABRIC TABLE COVERS



Sleek, sexy and formfitting – like a little black dress for your table.

- 4-way stretch polyester/spandex blend. Reinforced foot pockets hold cloth down.
- Wrinkle resistant. Machine washable.

Stretch Trash Can Covers, see uline.com



SPECIFY COLOR: Black or White

MODEL NO.	DIMENSIONS L x W x H	SHAPE	FITS TABLE	PRICE EACH	
				1	6+
S-22320	72 x 30 x 29"	Rectangle	72 x 30"	\$38	\$35
S-22321	96 x 30 x 29"		96 x 30"	45	41



# GATORADE®

Hardworking thirst quencher replaces fluids and minerals.

- Get more for your money. 6 gallon jumbo size powder.
- Choose from Fruit Punch, Orange, Lemon-Lime, Glacier Freeze or Riptide Rush.

**Assortment Pack includes:** Fruit Punch, Lemon-Lime, Orange and Riptide Rush.



2.5 GAL. PACKS

**POWDER** \*Only available in Orange, Lemon-Lime and Fruit Punch

MODEL NO.	DESCRIPTION	PACKS/ CASE	PRICE PER CASE		
			1	3	5+
S-15768*	1 Gallon Packs	40	\$119	\$117	\$115
S-11721	2.5 Gallon Packs	32	214	209	203
S-12936	6 Gallon Packs	14	205	200	194
S-11721ASST	2.5 Gal. Packs – Assortment	32	214	209	203

## GATORADE® SINGLE PACKS



GATORADE®

Single-serve, on-the-go packs for quick, easy hydration.

- Pocket-size pack makes up to 16.9 oz.

**Gatorade® Zero** – Zero sugar and all the electrolytes of regular Gatorade®.



GATORADE® ZERO

MODEL NO.	DESCRIPTION	SPECIFY FLAVOR	PACKS/ CASE	PRICE PER CASE		
				1	3	5+
S-24385	Gatorade®	Orange, Lemon-Lime or Fruit Punch	80	\$56	\$55	\$54
S-24341	Gatorade® Zero	Fruit Punch or Grape	120	84	82	80

## WATER BOTTLE

**CAMELBAK®**

For office, trail or gym.

- "Bite-and-sip" valve works like a straw.
- Spillproof. • BPA-free.



**FREE OFFER**  
Free upon request with any Uline order of \$300 or more.

MODEL NO.	DESCRIPTION	SIZE	PRICE EACH
S-17449	Water Bottle	32 oz.	\$15

## COOLERS AND RACKS



Insulated to keep water and drinks ice cold.

- Drip-proof spigot.
- Convenient carrying handles and cup dispenser bracket.

**Uline** – Flat lid doubles as a seat. Cup dispenser included.



**IGLOO®**

MODEL NO.	SIZE	PRICE EACH	
		1	2+
H-2851	2 Gallon Cooler	\$47	\$45
H-1961	3 Gallon Cooler	53	51
H-1353	5 Gallon Cooler	73	71
H-1631	10 Gallon Cooler	105	102

**ULINE**

MODEL NO.	SIZE	PRICE EACH	
		1	2+
H-5811	5 Gallon Cooler	\$52	\$50

**FREE ULINE COOLER** upon request with 3+ case 2.5 gal. Gatorade® order.

## LIQUID CONCENTRATE

**GATORADE®**

**Liquid Concentrate** – Mixes instantly. Makes up to 6 gallons.

- Choose from Fruit Punch, Orange, Lemon-Lime or Fierce Grape.



**Dispenser Rack** – Holds two 1 gallon bottles of concentrate. Includes two dispenser pumps.

MODEL NO.	DESC.	GAL./ CASE	PRICE PER CASE	
			1	3+
S-15776	1 Gal. Bottle	4	\$60	\$58
H-2537	Dispenser Rack	\$66 ea.	3+/\$64 ea.	



**Truck Racks** – Easily transport coolers to worksites and sporting events.

MODEL NO.	CAPACITY	PRICE EACH	
		1	2+
H-2852	2, 3 and 5 Gallon	\$79	\$76
H-2853	10 Gallon	92	89



### NATURAL

MODEL NO.	DIMENSIONS W x H	CAPACITY	MIL	STRENGTH	QTY./CTN.	PRICE PER CARTON			LBS./CTN.
						1	3	6+	
S-7317	24 x 24"	7-10 Gallon	.23	Light	1,000	\$34	\$32	\$29	10
S-7683			.31	Medium		44	42	40	13
S-7684	24 x 33"	12-16 Gallon	.23	Light	1,000	45	43	41	15
S-7318			.31	Medium	1,000	56	54	51	18
S-15512			.51	Heavy	500	48	46	44	15
S-7319	30 x 37"	20-30 Gallon	.39	Medium	500	45	43	41	15
S-7320			.63	Extra Heavy		67	65	63	24
S-7685	33 x 40"	33 Gallon	.43	Medium	500	59	57	55	20
S-5344			.51	Heavy	500	66	64	62	23
S-11669			.63	Extra Heavy	250	44	42	40	15
S-7321	40 x 48"	40-45 Gallon	.47	Medium	250	46	44	42	16
S-5345			.55	Heavy	250	54	51	49	18
S-5346			.63	Extra Heavy	250	61	59	57	21
S-14699			.75	Super Heavy	200	59	57	55	20
S-5347	36 x 60"	44-55 Gallon	.47	Medium	200	45	43	41	14
S-5348			.55	Heavy		49	47	45	17
S-5349			.67	Extra Heavy		59	57	55	20
S-7686	38 x 60"	60 Gallon	.67	Extra Heavy	200	61	59	57	21
S-11670*			.86	Super Heavy	150	61	59	57	21
S-13563	43 x 48"	56-60 Gallon	.47	Medium	200	44	42	40	14
S-13564			.55	Heavy		46	44	42	16
S-15513			.67	Extra Heavy		55	53	50	19

### ECONOMY

Economical, puncture-resistant bags reduce clean-up time in the workplace.

- Star seal bottom.
- Flat packed in convenient dispenser box.
- \* **Heavy Gauge Silver** – Strongest high-density trash liner, S-11670.
- Available in Natural or Black – Choose strength and size needed.

Office Can S-9970 shown above with S-7683 Liner.  
Corrugated Receptacle S-11855 shown above with S-5345 Liner.



Drum Liners, page 613.

### BLACK

S-13565	24 x 24"	7-10 Gallon	.31	Medium	1,000	\$44	\$42	\$40	13
S-13566	24 x 33"	12-16 Gallon	.31	Medium	1,000	56	54	51	18
S-15514	33 x 40"	33 Gallon	.51	Heavy	500	66	64	62	23
S-13567	40 x 48"	40-45 Gallon	.55	Heavy	250	54	51	49	18
S-5350	36 x 60"	44-55 Gallon	.47	Medium	200	45	43	41	14
S-5351			.55	Heavy		49	47	45	17
S-5352			.67	Extra Heavy		59	57	55	20
S-15515	38 x 60"	60 Gallon	.67	Extra Heavy	200	61	59	57	21

## TRASH CAN BANDS



Avoid the mess!

- Prevent trash liners from slipping into containers.
- Holds trash liner in place.

Rubber Bands, page 109, Pallet Bands, page 297.

MODEL NO.	SIZE L x W	FITS CAN SIZE	QTY./CTN.	PRICE PER CTN.	
				1	2+
S-7752	8½ x 1/8"	23-32 Gal.	600	\$27	\$26
S-7753	14 x 1/4"	32-50 Gal.	200	45	43
S-13561	17 x 1/4"	55-65 Gal.	400	88	85

### INDUSTRIAL

Don't "mess" with lightweight, flimsy bags.

- Premium linear low density – Provides excellent puncture and tear resistance.
- Handles heavy items and sharp corners without tearing.
- Strongest bags on the market – Made with premium resins.
- Uline Extra Heavy Bags are over 45% thicker than Sure Sak® liners.
- Star seal bottom.

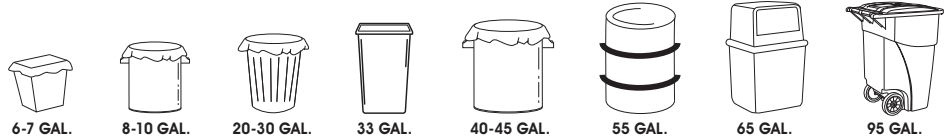

PUNCTURE RESISTANT

**STANDARD STRENGTH** – General purpose use – For light to medium trash loads.

**MEDIUM STRENGTH** – For paper and void fill.

**HEAVY STRENGTH** – For boxes, wood and heavier scraps.

**EXTRA HEAVY STRENGTH** – For your heaviest warehouse trash.

**BLACK** – Hides bag contents.



Trash Cans with Wheels, page 399.

MODEL NO.		DIMENSIONS W x H	CAPACITY	MIL	STRENGTH	QTY./ CTN.	PRICE PER CARTON			LBS./ CTN.
BLACK	CLEAR						1	3	6+	
S-15533	S-7314	24 x 23"	6-7 Gallon	.75	Standard	500	\$49	\$47	\$45	14
S-15534	S-3367			1.2	Medium	250	42	40	38	11
S-15535	S-3368			1.5	Heavy	250	48	46	44	14
S-11673	S-7315	24 x 30"	8-10 Gallon	.75	Standard	500	61	59	57	18
S-11674	S-6999			1.2	Medium	250	50	48	46	15
S-11675	S-7000			1.5	Heavy	250	60	58	56	18
S-23070	S-23071	24 x 33"	12-16 Gallon	.75	Standard	250	36	34	32	13
S-13575	S-13571			1.2	Medium		54	51	49	17
S-13576	S-13572			1.5	Heavy		62	60	58	21
S-22445	S-22445	29 x 46"	23 Gallon	1.5	Heavy	200	<b>\$69 each any qty.</b>			28
S-11676	S-7681	30 x 36"	20-30 Gallon	1.2	Medium	250	69	67	65	22
S-11677	S-7682			1.5	Heavy		82	80	78	28
S-15536	S-7316	33 x 39"	33 Gallon	.75	Standard	250	54	51	49	16
S-5104	S-2052			1.2	Medium	250	80	78	76	26
S-5105	S-2053			1.5	Heavy	250	92	90	88	32
S-5106	S-3901			2.5	Extra Heavy	100	68	66	64	22
S-17599*	S-17600*	35 x 50"	33-44 Gallon	1.2	Medium	100	42	40	38	14
S-5107	S-3369	40 x 46"	40-45 Gallon	1.2	Medium	100	49	47	45	15
S-5108	S-3370			1.5	Heavy		60	58	56	19
S-5109	S-5112			2.5	Extra Heavy		92	90	88	32
S-5110	S-2054	36 x 58"	44-55 Gallon	1.2	Medium	100	54	51	49	17
S-5111	S-2055			1.5	Heavy		62	60	58	21
S-3528	S-3529			2.5	Extra Heavy		101	99	97	35
S-15537	S-15538	38 x 58"	55-60 Gallon	2.0	Heavy	100	89	87	85	29
S-11678	S-15539			2.5	Extra Heavy	75	82	80	78	28
S-13577	S-13573	39 x 58"	55-60 Gallon	1.5	Heavy	100	<b>\$65 each any qty.</b>			24
S-13578	S-13574			2.5	Extra Heavy	75	83	81	79	29
S-23074	S-23075	44 x 55"	65 Gallon	2.0	Heavy	75	84	82	80	24
S-23677*	S-23677*	52 x 60"	75 Gallon	2.0	Heavy	75	91	89	87	31
S-12615*	S-15540*	58 x 62"	95 Gallon	2.5	Extra Heavy	50	92	90	88	30
S-12614*	S-15541*	63 x 50"	96 Gallon				82	80	78	26

\* Flat seal bottom



# CONTRACTOR'S BAGS

LINEAR LOW DENSITY



Don't "mess" with lightweight, flimsy bags.

- Maximum puncture and tear resistance.
- Roll packed. Flat seal bottom.
- For site cleanup, demolition and remodeling.

SPECIFY COLOR: Black or Clear

MODEL NO.	SIZE W x H	CAPACITY	MIL	STRENGTH	QTY./ CTN.	PRICE PER CARTON		LBS./ CTN.
						1	3+	
S-14698	30 x 36"	30 Gallon	3	Heavy	30	\$21	\$20	7
S-22477			6	Extra Heavy		43	41	13
S-11679	32 x 50"	40-45 Gallon	3	Heavy	20	21	20	7
S-19875			6	Extra Heavy		15	32	29
S-12949	36 x 58"	44-55 Gallon	3	Heavy	15	22	21	6
S-15584			6	Extra Heavy		15	45	43
S-18435	39 x 58"	55-60 Gallon	3	Heavy	15	24	23	7
S-19876			6	Extra Heavy		15	48	46
S-22478	56 x 64"	95 Gallon	3	Heavy	15	37	35	14
S-22479			6	Extra Heavy		15	74	69

## DRAWSTRING LINERS

LINEAR LOW DENSITY



Convenient drawstring. Easy to close, lift, carry.

- Keep hands clean and free of trash.
- Durable liners fit Brute® containers.

## RECYCLING LINERS

LINEAR LOW DENSITY



Easily separate, identify and dispose of recycling materials.

- For cans, paper and plastic.
- Star seal bottom.
- Resists punctures and tears.



H-2628 BAG BUDDY™, see uline.com

\* Black only

SPECIFY COLOR: Black, White or Clear

MODEL NO.	SIZE W x H	CAPACITY	MIL	QTY./ CTN.	PRICE PER CARTON	
					1	3+
S-15583	24 x 28"	13 Gallon	.8	400	\$70	\$68
S-21324	29 x 38"	23 Gallon	1.0	200	56	54
S-13524	33 x 38"	33 Gallon	1.4	150	61	59
S-13525*	37 x 45"	44 Gallon	1.4	150	76	74
S-13526*	40 x 45"	55 Gallon	1.4	100	64	62

MODEL NO.	SIZE W x H	CAPACITY	MIL	QTY./ CTN.	PRICE PER CARTON	
					1	3+
S-15507	24 x 33"	12-16 Gallon	1.0	250	\$50	\$48
S-15508	30 x 36"	20-30 Gallon	1.0	250	64	62
S-12965	33 x 39"	33 Gallon	1.0	250	71	69
S-12966	40 x 46"	40-45 Gallon	1.2	100	50	48
S-12981	39 x 58"	55 Gallon	1.5	100	71	69



## ULINE CORELESS TRASH LINERS

HIGH DENSITY

\* SPECIFY COLOR: Clear or Black

MODEL NO.	DIMENSIONS W x H	CAPACITY	MIL	STRENGTH	QTY./ CTN.	PRICE PER CARTON			LBS./ CTN.
						1	3	6+	
S-15510	17 x 20"	4 Gallon	.23	Light	2,000	\$43	\$41	\$39	12
S-15511	20 x 22"	7 Gallon	.23	Light	2,000	50	48	46	15
S-7322	24 x 24"	7-10 Gallon	.23	Light	1,000	34	32	29	10
S-11671*	24 x 33"	12-16 Gallon	.31	Medium	1,000	56	54	51	18
S-7323*	30 x 37"	20-30 Gallon	.39	Medium	500	45	43	41	15
S-7324	33 x 40"	33 Gallon	.43	Medium	500	59	57	55	20
S-13568*	40 x 48"	40-45 Gallon	.55	Heavy	250	54	51	49	18
S-7325			.63	Extra Heavy		61	59	57	21
S-13569	36 x 60"	44-55 Gallon	.55	Heavy	200	49	47	45	17
S-7326			.67	Extra Heavy		59	57	55	20
S-13570*	38 x 60"	60 Gallon	.67	Extra Heavy	200	61	59	57	21

Easily refill multiple trash cans with roll packed liners.

- Take a roll at a time. Portable, lightweight.
- Roll packed bags in dispenser box.
- Star seal bottom.

Premium bags stand up to heavy, bulky or wet trash.

- Superior strength and puncture resistance.
- \* 56-60 gallon liners fit Trash Can with Wheels (H-1107), page 399.

MODEL NO.	DIMENSIONS W x H	CAPACITY	MIL	QTY./ CTN.	PRICE PER CARTON			LBS./ CTN.
					1	3	6+	
S-10227	30 x 36"	20-30 Gallon	1.5	100	\$46	\$44	\$42	11
S-10278	33 x 40"	33 Gallon	1.5	100	54	51	49	13
S-10280	39 x 46"	40-45 Gallon	1.7	50	43	41	39	10
S-10331	39 x 56"	55 Gallon	1.7	50	<b>\$44 per carton any quantity</b>			12
S-11672*	43 x 48"	56-60 Gallon	1.7	50	48	46	44	12
S-15506	38 x 58"	60 Gallon	1.7	50	49	47	45	12
S-13522	44 x 55"	65 Gallon	1.7	50	55	53	50	14



## COLORED TRASH LINERS

### LINEAR LOW DENSITY

Identify different types of waste, recyclables and production materials.

- Use in restaurants, offices, healthcare and manufacturing facilities.
- Star seal bottom is virtually leakproof. Puncture and tear resistant.

SPECIFY COLOR: Red, Orange, Yellow, Green, Purple, Blue, White or Gray

MODEL NO.	DIMENSIONS W x H	CAPACITY	MIL	QTY./ CTN.	PRICE PER CARTON			LBS./ CTN.
					1	3	6+	
S-19943	24 x 33"	12-16 Gallon	1.5	250	\$65	\$63	\$61	20
S-15542	33 x 39"	33 Gallon		250	103	101	99	32
S-15543	40 x 46"	40-45 Gallon		100	68	66	64	18
S-15544	36 x 58"	44-55 Gallon		100	70	68	66	21



## BIOHAZARD BAGS

### LINEAR LOW DENSITY

Isolate hazardous items in hospitals, doctors' offices and healthcare facilities.

- Puncture resistant.
- Flat seal bottom. Flat packed in carton.

\* Red only SPECIFY COLOR: Red Infectious Waste, Blue Soiled Linen or Yellow Infectious Linen

MODEL NO.	DIMENSIONS W x H	CAPACITY	MIL	QTY./ CTN.	PRICE PER CARTON			LBS./ CTN.
					1	3	6+	
S-12984*	24 x 23"	7-10 Gallon	1.2	200	\$41	\$39	\$37	10
S-20849*	30 x 36"	20-30 Gallon	1.2	200	59	57	55	18
S-12985	33 x 39"	33 Gallon	2.0	100	57	55	53	20
S-12986	40 x 46"	40-45 Gallon	2.0	100	77	75	72	25
S-17202*	40 x 46"	40-45 Gallon	3.0	75	85	83	81	29



## BIOHAZARD STEP-ON WASTE CANS

Provide temporary storage of infectious waste or combustible material.

- Step-on foot pedal provides hands-free operation.
- High-density polyethylene resists rust, dents and most chemicals.
- Seamless and leakproof base with molded-in handles.
- Self-closing lid.

OSHA compliant for exposure to bloodborne pathogens

MODEL NO.	DESCRIPTION	DIMENSIONS L x W x H	WT. (LBS.)	PRICE EACH	
				1	3+
H-5191	6 Gallon	14 x 17 x 16"	9	\$96	\$93
H-6566	10 Gallon	18 x 22 x 18"	14	114	110
H-5192	14 Gallon	18 x 22 x 21"	16	131	126

# ULINE WASTE CONTAINERS

Industrial strength. Uline value.

- Recommended for offices, schools and your outdoor events.
- All plastic. Won't dent or crack.
- Built-in handles for easy lifting.
- Nestable when empty.



SPECIFY COLOR:

■ Red   
 ■ Yellow   
 ■ Black   
 ■ Gray   
 ■ Blue   
 ■ White   
 ■ Lime   
 ■ Orange

CONTAINERS	MODEL NO.	DESCRIPTION	SIZE H x D	WT. (LBS.)	PRICE EACH		
					1	3	5+
	H-3687	32 Gallon	27 x 22"	8	\$33 each any quantity		
	■H-3688	44 Gallon	31 x 24"	14	\$52	\$50	\$48
	■H-3689	55 Gallon	33 x 26"	18	\$74 each any quantity		

USDA compliant. NSF certified.

■ SHIPS VIA MOTOR FREIGHT

**LIDS**

MODEL NO.	DESCRIPTION	SIZE	WT.	1	3	5+
H-4199	32 Gallon	1 x 22"	3	\$14	\$13	\$12
H-4200	44 Gallon	1 x 24"	3	22	21	20
H-4201	55 Gallon	2 x 26"	4	28	27	26

Lids not available in Lime or Orange

## ULINE THIN CONTAINERS

Space-saving shape for tight areas. Recommended for bars, kiosks and checkouts.



- Tough plastic won't crack or dent.
- Seamless design is easy to clean.
- Use indoors or out.
- Compatible with Slim Jim® Lids, see below.

SPECIFY COLOR:

■ Red   
 ■ Black   
 ■ Gray   
 ■ Blue   
 ■ Green

CONTAINERS	MODEL NO.	DESCRIPTION	SIZE L x W x H	WT. (LBS.)	PRICE EACH		
					1	4	8+
	H-5148	23 Gallon	20 x 11 x 30"	8	\$45 each any quantity		

**INDUSTRIAL LINERS – 1.5 MIL**

SPECIFY COLOR: Black or Clear

MODEL NO.	CAPACITY	SIZE W x H	QTY. (CTN.)	PRICE PER CARTON		
				1	3	6+
S-22445	23 Gallon	29 x 46"	200	\$69 each any quantity		

## SLIM JIM® CONTAINERS

RUBBERMAID®

Slim and trim to save space.

- Handle design holds liners securely.
- Vented side channels for easy liner removal.



SPECIFY COLOR:

■ Yellow   
 ■ Black   
 ■ Gray   
 ■ Beige

SLIM JIM®	MODEL NO.	DESCRIPTION	SIZE L x W x H	WT. (LBS.)	PRICE EACH		
					1	4	8+
	H-2894	23 Gal. Vented	22 x 11 x 30"	8	\$62 each any quantity		

**INDUSTRIAL LINERS – 1.5 MIL**

SPECIFY COLOR: Black or Clear

MODEL NO.	CAPACITY	SIZE W x H	QTY. (CTN.)	PRICE PER CARTON		
				1	3	6+
S-22445	23 Gallon	29 x 46"	200	\$69 each any quantity		

## SLIM JIM® LIDS



Keep trash out of sight. Tough plastic, easy to clean.

\* Blue or Green

MODEL NO.	DESCRIPTION	SIZE L x W	WT. (LBS.)	PRICE EACH		
				1	3	6+
H-1633	Swing Top	21 x 11"	3	\$51	\$48	\$46
H-1634*	Can/Bottle		1	52	49	47
H-9956*	Mixed Recycling					

## SLIM JIM® TROLLEY

Link together and move multiple containers in one trip.

- Dollies detach easily for individual use.
- Durable plastic won't crack, dent or chip.

USE WITH:

- Uline Thin Containers
- Slim Jim® Containers
- Slim Jim® Recycling Containers



MODEL NO.	CAPACITY	SIZE L x W x H	WT. (LBS.)	PRICE EACH		
				1	3	6+
H-2621	200 lbs.	24 x 15 x 8"	5	\$101	\$99	\$96



# BRUTE® CONTAINERS AND LIDS

RUBBERMAID®

CONTAINERS SPECIFY COLOR:  Gray  Green  Red  Yellow  White  Blue  Black

MODEL NO.	DESCRIPTION	SIZE H x D	WT. (LBS.)	PRICE EACH		
				1	3	5+
H-1853	10 Gallon	17 x 16"	3	\$25	\$24	\$23
H-1854	20 Gallon	23 x 19"	6	35	34	33
H-1045	32 Gallon	28 x 22"	8	48	45	43
■H-1046	44 Gallon	32 x 24"	13	67	65	63
■H-1047	55 Gallon	33 x 26"	16	108	105	102

NSF certified

■ SHIPS VIA MOTOR FREIGHT

## FLAT LIDS

MODEL NO.	DESCRIPTION	SIZE H x D	WT. (LBS.)	PRICE EACH		
				1	3	5+
H-1856	20 Gallon	2 x 20"	2	\$13	\$12	\$11
H-1048	32 Gallon	2 x 22"	2	19	18	17
H-1049	44 Gallon	2 x 25"	3	28	27	26
H-1050	55 Gallon	2 x 27"	3	38	37	35

Lids not available in Yellow or Green

Tough containers that handle your heaviest loads.

- Heavy-duty plastic construction resists denting, bending and cracking.
- Molded-in handles make lifting easy.
- Vented side channels for easy trash liner removal.
- 10 and 20 gal. – Compact size for restaurant storage.



## DELUXE LIDS

### DOME LIDS

SPECIFY COLOR: Gray, Red, Black or Blue

MODEL NO.	DESCRIPTION	SIZE H x D	WT. (LBS.)	PRICE EACH		
				1	3	5+
H-1473	32 Gallon	12 x 23"	11	\$107	\$104	\$98
H-1474	44 Gallon	12 x 25"	12	116	112	109
H-1475*	55 Gallon	14 x 27"	14	160	155	150

\* Not available in Blue

### STEEL DOME LIDS

SPECIFY COLOR: Green, Red, Black or Blue

H-1857	55 Gallon	11 x 25"	12	\$121	\$118	\$114
--------	-----------	----------	----	-------	-------	-------

### FUNNEL LID

H-2098	32 Gallon	5 x 22"	2	\$62	\$59	\$56
--------	-----------	---------	---	------	------	------

- Plastic Dome Lids – Tough and lightweight. Self-closing swing door keeps trash and odors out of sight.



- Steel Dome Lids – Rugged steel construction. Self-closing swing door. Fits any 55 gallon steel drum or 44 gallon Brute®. Stable, sturdy, easy to use.
- Funnel Lid – Sturdy gray plastic. Center hole directs and keeps trash inside.

## WHEELED BRUTE®

New



Roll heavy debris right to the dumpster.

- Recommended for construction and landscaping.
- 5½" solid rubber wheels withstand rough terrain.

RUBBERMAID®

NSF certified

MODEL NO.	DESCRIPTION	WT. (LBS.)	PRICE EACH		
			1	3	5+
H-10733	44 Gallon	18	\$77	\$75	\$73

## DOLLIES

Heavy-duty plastic construction resists denting, bending and cracking.

- Easily move heavy-loaded containers.
- Quiet Dolly – Eliminates 88% of traditional dolly noise.
- Tandem Dolly – A real timesaver. Hinged design folds flat. Fits most Brute® containers.



MODEL NO.	DESCRIPTION	SIZE	WT. (LBS.)	PRICE EACH		
				1	3	5+
H-7928	Uline Dolly			\$39	\$37	\$35
H-1051	Brute® Dolly	6 x 18"	6	55	53	50
H-2630	Quiet Dolly			105	103	100
H-2097	Tandem Dolly	8 x 45"	20	205	200	195

# GLUTTON® RECEPTACLES



RUBBERMAID®

Rugged construction. For indoor or outdoor use.

- Sanitary. Hands-free rain shield avoids cross contamination.
- Heavy-duty polyethylene resists denting, bending or cracking.
- Withstands extreme temperatures – steam cleaning to sub-zero.

SPECIFY LID COLOR: Red or Brown

MODEL NO.	DESCRIPTION	CAPACITY	SIZE L x W x H	WT. (LBS.)	PRICE EACH	
					1	3+
H-2184	Glutton®	56 Gallon	26 x 23 x 44"	31	\$465	\$445

# RANGER® RECEPTACLES



RUBBERMAID®

Dependable in the roughest weather conditions.

- Pedestal base for stability and security.

**4-way entry** – No excuse not to pitch your trash!

**2-way entry** – Swing doors keep trash and odors inside.

SPECIFY COLOR: Beige or Black

MODEL NO.	DESCRIPTION	CAPACITY	SIZE L x W x H	WT. (LBS.)	PRICE EACH	
					1	3+
H-2459	4-Way	45 Gallon	25 x 25 x 42"	38	\$515	\$505
H-2460	2-Way	45 Gallon	25 x 25 x 42"	43	550	540

SHIPS VIA MOTOR FREIGHT



# HEXAGON RECEPTACLE

They're everywhere – office buildings, movie theaters, malls and gas stations.

- Economical, large-capacity receptacle for high-traffic areas.
- Tough polyethylene won't rust, dent, chip or fade.
- Lift-off lid with 9½" hexagon opening.

MODEL NO.	DESCRIPTION	CAPACITY	SIZE DIAM. x H	WT. (LBS.)	PRICE EACH		
					1	3	6+
H-6569	Hexagon	45 Gallon	22 x 30"	14	\$140	\$135	\$130

# SIMPLEHUMAN® TRASH LINERS



simplehuman® liners fit your can perfectly.

- Handy liner packs for quick and easy dispensing.
- Convenient drawstring handle.

More liners, see [uline.com](http://uline.com)

MODEL NO.	DESCRIPTION	CAPACITY	QTY./ CTN.	PRICE PER CARTON	
				1	4+
S-23531	simplehuman® J	12 Gallon	60	\$25	\$24
S-23528	simplehuman® P	16 Gallon	60	29	28

# ECO-FRIENDLY TRASH LINERS

Puncture-resistant "green" liners are tough enough for industrial use.

- Complies with LEED requirements for "green" purchasing.
- 80% recycled resins. 



MODEL NO.	DESCRIPTION	CAPACITY	QTY./ CTN.	PRICE PER CARTON		
				1	3	6+
S-19886	Eco-Friendly	40-45 Gallon	100	\$54	\$51	\$49
S-19888		55-60 Gallon	100	61	59	57

# GLAD® TRASH BAGS

Love these drawstring bags. Tough, durable. Convenient drawstring handle.

**ForceFlex® Bags** – Incredible stretching power prevents punctures. Dispose of pizza boxes and other irregularly shaped items.



FORCEFLEXPLUS

ODORSHIELD®

MODEL NO.	DESCRIPTION	QTY./ BOX	CAP. (GAL.)	PRICE PER BOX		
				1	4	8+
S-11722	ForceFlex® Tall Kitchen	100	13	\$29	\$28	\$27
S-11723	Outdoor Bags	90	30	35	34	33
S-14766	ForceFlex® OdorShield®	100	13	32	31	30
S-14767	ForceFlexPlus Outdoors	90	33	39	38	37



KITCHEN

OUTDOOR

# TRASH CANS WITH WHEELS

Mobile and able to travel to many areas.

- Hinged plastic lid controls trash and odors. • 8" wheels, 50 gal.; 10" wheels, 65/95 gal.
- Large capacity, stable in high winds and on uneven surfaces.



\* SPECIFY COLOR: Gray or Yellow

SHIPS VIA MOTOR FREIGHT

MODEL NO.	SIZE L x W x H	CAPACITY	WT. (LBS.)	PRICE EACH		RECOMMENDED BAG
				1	3+	
H-1107*	30 x 24 x 40"	50 Gallon	25	\$145	\$135	S-11672
H-1578	32 x 25 x 45"	65 Gallon	34	235	215	S-23074
H-1579	37 x 29 x 46"	95 Gallon	39	260	240	S-12615

# OFFICE TRASH CANS



RUBBERMAID®

Space-efficient trash cans fit under desks.

- Lightweight plastic won't dent, rust or chip.
- Rolled rim adds strength, holds up liners.

SPECIFY COLOR:  Gray  Beige  Black

MODEL NO.	SIZE L x W x H	CAPACITY	WT. (LBS.)	PRICE EACH		
				1	3	6+
S-14491	11 x 8 x 12"	3 Gallon	1	N/A	\$9	\$8
S-9970	14 x 10 x 15"	7 Gallon	2	N/A	10	9
S-13527	15 x 11 x 20"	10 Gallon	3	\$18	17	16

simplehuman®

Keep it classy in your office or workspace.

- Smudge-proof brushed stainless always looks clean.

H-8664 – Features two compartments for sorting your recyclables.



2 YEAR WARRANTY

MODEL NO.	SIZE L x W x H	CAPACITY	WT. (LBS.)	PRICE EACH		
				1	3	6+
H-8663	11 x 6 x 13"	3 Gallon	4	\$54	\$52	\$50
H-8664	17 x 9 x 15"	5 Gallon	8	84	82	80
H-8665	17 x 9 x 15"	7 Gallon	8	84	82	80



# SENSOR TRASH CAN

simplehuman®

Opens automatically with a wave of the hand. For kitchens and coffee shops.

- Smudge-proof brushed stainless steel.
- Flat back fits flush against wall.

MODEL NO.	SIZE L x W x H	CAPACITY	WT. (LBS.)	PRICE EACH		RECOM. BAG
				1	3+	
H-7954	13 x 16 x 25"	12 Gallon	10	\$205	\$200	S-23531

4 AA batteries included

2 YEAR WARRANTY

# STEP-ON TRASH CAN

simplehuman®

Step-on foot pedal quietly opens lid. For breakrooms and day cares.

- Strong plastic won't dent or crack.
- Sliding lock keeps pets and children out.



MODEL NO.	SIZE L x W x H	CAPACITY	WT. (LBS.)	PRICE EACH		RECOM. BAG
				1	3+	
H-9142	19 x 14 x 27"	13 Gallon	9	\$85	\$80	S-23528

2 YEAR WARRANTY

# ULINE TRASH BAGS

Uline quality at a great price.

- Convenient drawstring. Easy to close, lift and carry.
- Keep hands clean and free of trash.

Uline Max-Flex – Strong, stretchable bags grip can tightly, resist punctures and tears.



SPECIFY COLOR: White, Black or Clear

SPECIFY COLOR: White or Black

MODEL NO.	DESCRIPTION	QTY./ CTN.	CAP. (GAL.)	PRICE PER CARTON		
				1	3	6+
S-15583	Tall Kitchen	400	13	\$70	\$68	\$66
S-13524	Outdoor Bags	150	33	61	59	57

MODEL NO.	DESCRIPTION	QTY./ CTN.	CAP. (GAL.)	PRICE PER CARTON		
				1	3	6+
S-23038	Max-Flex Kitchen	150	13	\$28	\$27	\$26
S-23039	Max-Flex Outdoors	90	33	32	31	30



# RUBBERMAID® TRASH RECEPTACLES



## HANDS-FREE RECEPTACLES

Lasts for a lifetime. Most durable, crack-resistant plastic receptacle made.

- Drop-in lid quickly closes to control odors and hide contents from view.
- Easy to clean – Resists dents, impact and corrosion.
- Belongs in every cafeteria and breakroom.

SPECIFY COLOR:  Beige  Black  Gray

MODEL NO.	DESCRIPTION	SIZE L x W x H	WT. (LBS.)	PRICE EACH		
				1	3	6+
H-2445	23 Gallon	16 x 16 x 36"	9	\$125	\$120	\$115
H-1467	35 Gallon	20 x 20 x 33"	13	190	180	175
H-2183*	50 Gallon	20 x 20 x 41"	20	255	245	235

\* Not available in Beige



## STEP-ON CONTAINERS

Hands-free trash disposal.

- Heavy-duty foot pedal quietly opens lid.
- Tight-fitting lid contains odors.

- Durable plastic. Recommended for offices and warehouses.

SPECIFY COLOR:  Red  Beige  Black  White

MODEL NO.	DESCRIPTION	SIZE L x W x H	WT. (LBS.)	PRICE EACH		
				1	3	6+
H-2668	12 Gallon	16 x 16 x 24"	9	\$145	\$140	\$135
H-2669*	18 Gallon	20 x 16 x 27"	12	165	160	150
H-2670	23 Gallon	20 x 16 x 33"	16	235	225	220

\* Not available in Black

## HALF-ROUND RECEPTACLES



Space-saving design fits snugly against the wall.

- Large capacity for tight areas.
- Durable plastic won't crack or dent – even outdoors.
- Self-closing lid keeps odors in. Lid sold separately.

RUBBERMAID® \* SPECIFY COLOR:  Beige  Gray

MODEL NO.	DESCRIPTION	SIZE L x W x H	WT. (LBS.)	PRICE EACH		
				1	3	6+
H-1865*	21 Gallon	21 x 11 x 28"	8	\$65	\$60	\$55
H-1866	Black Lid		4	45	42	40

## DOMED WASTE RECEPTACLES

Long lasting, rugged and fire safe.

Steel – Corrosion resistant. Removable galvanized steel liner.

Plastic – Structural foam resists dents and cracks. Easy to clean and empty.

- Factory Mutual (FM) approved for fire safety.



\* SPECIFY COLOR:  Beige  Brown  Black

MODEL NO.	DESCRIPTION	SIZE DIAM. x H	WT. (LBS.)	PRICE EACH		
				1	3	6+
H-1476	15 Gallon Steel	15 x 36"	25	\$219	\$209	\$199
H-1197*	25 Gallon Plastic	18 x 42"	23	280	270	260



## STAINLESS STEEL HALF-ROUND CONTAINERS

simplehuman®

Long lasting and worth the price. Fits tight to wall.

- Smudge-proof brushed stainless steel always looks clean.
- Wide opening for breakrooms and high-traffic areas.
- Custom fit simplehuman® Liners are your can's perfect match.
- Touch-free toss and go waste disposal.

2 YEAR WARRANTY

MODEL NO.	DESCRIPTION	SIZE L x W x H	WT. (LBS.)	PRICE EACH		RECOM. BAG
				1	3+	
H-4454	16 Gallon	19 x 13 x 30"	17	\$180	\$175	S-23528
H-8672	21 Gallon	21 x 14 x 30"	25	230	225	S-23690

# SIMPLEHUMAN® STAINLESS STEEL CONTAINERS

## OPEN TOP



H-3621

H-3622

Long lasting. Worth the price.

- Wide opening for breakrooms and high-traffic areas.
- Smudge-proof brushed stainless steel always looks clean.
- Touch-free toss and go waste disposal.
- Custom fit liners are your can's perfect match.



H-7953

H-7364

2 YEAR WARRANTY

MODEL NO.	DESCRIPTION	SIZE L x W x H	WT. (LBS.)	PRICE EACH		RECOM. BAG
				1	3+	
H-3621	13 Gallon	11 x 18 x 28"	14	\$145	\$140	S-23527
H-3622	16 Gallon	16" Diam. x 30" H	17	160	155	S-23528

2 YEAR WARRANTY

MODEL NO.	DESCRIPTION	SIZE L x W x H	WT. (LBS.)	PRICE EACH		RECOM. BAG
				1	3+	
H-7953	21 Gallon	18" Diam. x 30" H	19	\$210	\$205	S-23529
H-7364	30 Gallon	19" Diam. x 32" H	21	270	260	S-23530

## JUMBO STEP-ON



Extra-wide design. Used in busy cafés, hotels and country clubs.

- Hinged lid locks up for easy liner replacement. Quiet close.
- Liner rim holds bags in place and provides a clean look.
- Store and dispense liners from built-in pocket.

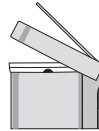

2 YEAR WARRANTY

MODEL NO.	DESCRIPTION	SIZE L x W x H	WT. (LBS.)	PRICE EACH		RECOM. BAG
				1	3+	
H-10736	14 Gallon	14 x 19 x 26"	20	\$185	\$180	S-24903

## STEP-ON

Convenient hands-free disposal for restrooms and clinics.

- Built to last. Hides trash and contains odors.
- Smudge-proof brushed stainless steel always looks clean.



H-3623

H-6671

H-3623 – Includes removable plastic liner.

2 YEAR WARRANTY

MODEL NO.	DESCRIPTION	SIZE L x W x H	WT. (LBS.)	PRICE EACH		RECOM. BAG
				1	3+	
H-3623	10 Gallon	16 x 13 x 26"	19	\$150	\$145	S-23531
H-6671	16 Gallon	18 x 16 x 26"	20	185	180	S-23528

## SIDE-ENTRY RECEPTACLES



H-4179

Stylish, space-saving design for hallways, lobbies and bathrooms.

- Semi-round shape – Fits snugly against wall.
- Large, 14 x 5" side opening.
- Fire-safe steel construction.
- Includes leakproof hard plastic liner.



MODEL NO.	DESCRIPTION	SIZE L x W x H	WT. (LBS.)	PRICE EACH		
				1	3	6+
H-4178	9 Gallon Black	18 x 9 x 32"	26	\$170	\$160	\$150
H-4179	9 Gallon Stainless			251	236	220

## LOBBY RECEPTACLES

Sleek, modern design for lobbies, airports or theaters.

- Wide opening for high-traffic areas.

H-2867 – 9" opening. Satin finish. Heavy gauge aluminum construction.

H-3490 – 5" opening. Stainless steel. Smooth finish.



H-2867

\* Includes hard plastic liner

MODEL NO.	DESCRIPTION	SIZE DIAM. x H	WT. (LBS.)	PRICE EACH		
				1	2	4+
H-3490	7 Gallon	10 x 20"	8	\$185	\$170	\$155
H-2867*	35 Gallon	18 x 32"	35	\$299 each any qty.		

## PLASTIC SMOKER'S RECEPTACLES



Eliminate cigarette litter from public areas.

- Extinguishes cigarettes quickly.
- Base holds (and conceals) thousands of cigarette butts.
- Unscrew and lift off lid for easy disposal.

SPECIFY COLOR: Gray, Beige, Green, Terra Cotta or Black

MODEL NO.	SIZE DIAM. x H	WEIGHT (LBS.)	PRICE EACH	
			1	3+
H-1103	17 x 39"	13	\$69	\$66
S-17201	Receptacle Liners 10/pk.		\$44/pk.	\$42/pk.

## METAL SMOKER'S RECEPTACLE

Tough, safe steel construction won't burn or melt.

- Low maintenance – Conceals thousands of cigarette butts.
- Self-extinguishing design.

MODEL NO.	SIZE DIAM. x H	WT. (LBS.)	PRICE EACH	
			1	3+
H-1377	16 x 39"	23	\$215	\$210



## SMOKER'S POLE

Streamlined space-saver.

- Fire-safe, weather resistant, powder-coated aluminum.
- Self-extinguishing. No sand or water needed.

SPECIFY COLOR: Black or Silver

MODEL NO.	SIZE DIAM. x H	WT. (LBS.)	PRICE EACH	
			1	3+
H-2458	13 x 41"	24	\$255	\$245

RUBBERMAID®



## TUSCAN SMOKER'S POLE

RUBBERMAID®



Combines clean good looks with easy maintenance.

- Durable plastic with inner galvanized steel liner lifts out to empty.
- Self-extinguishing.

SPECIFY COLOR: Black or Beige

MODEL NO.	SIZE L x W x H	WT. (LBS.)	PRICE EACH	
			1	3+
H-4198	13 x 13 x 38"	16	\$200	\$190

## INFINITY™ SMOKER'S RECEPTACLES

RUBBERMAID®

High-capacity receptacles hold up to 8,000 cigarette butts.

- Stainless steel snuff plate minimizes smoldering.
- Self-extinguishing. Chubby.



TRADITIONAL HIGH CAPACITY

MODEL NO.	DESCRIPTION	SIZE DIAM. x H	CIGARETTE CAPACITY	WT. (LBS.)	PRICE EACH	
					1	3+
H-5161	Traditional	13 x 39"	5,000	24	\$275	\$265
H-5162	High Capacity	16 x 42"	8,000	33	380	360



### JUMBO

Holds maintenance equipment, brooms and shovels.



### SLIM

Grid floor keeps brooms and mops in place.

## STORAGE SHEDS

SUNCAST®

Organize your equipment and supplies indoors or outdoors.

- Weather-resistant plastic won't rust or rot.
- Interlocking panels assemble in less than 30 minutes.
- Flooring included. Keeps out moisture and dirt.
- Doors can be padlocked. Shelves available, see uline.com

SHIPS UNASSEMBLED VIA MOTOR FREIGHT

MODEL NO.	DESCRIPTION	CAPACITY (CU. FT.)	SIZE W x D x H	WT. (LBS.)	PRICE EACH	
					1	2+
H-10019	Slim	22	32 x 25 x 72"	68	\$270	\$260
H-9558	Jumbo	54	53 x 33 x 72"	102	430	420



# CORRUGATED RECEPTACLES

Recommended for company events and trade shows.

- Sturdy 200 lb. single wall corrugated.
- 7 Gallon – Fits under desks, tables and counters.
- Lid fits S-11855 and S-13678 receptacles.
- Ship and store flat to save space.
- Plastic trash liners extend life, see page 392.



SPECIFY DESIGN: Waste, Recycle Logo or Blank

SOLD IN BUNDLE QUANTITIES

MODEL NO.	DESCRIPTION	SIZE L x W x H	LBS./BUNDLE	PRICE EACH		QTY./BUNDLE
				10	20+	
S-14464*	7 Gallon Receptacles	15 x 11 x 15"	15	N/A	\$3.20	20
S-11855	40 Gallon Receptacles	18 x 18 x 30"	28	\$9.10 any qty.		10
S-13678	50 Gallon Receptacles	18 x 18 x 36"	35	\$14.45	12.75	
S-13937	Lid with Hole	18 x 18 x 3"	1	3.20	2.80	10

\* Not available in Blank

# WIRE MESH CONTAINERS

Recommended for beaches, parks, fairs, public walkways.

- Open mesh controls odor.
- Nest together for easy storage.
- Rust-free. Perforated bottom for rain and melting snow.

Steel Dome Lid – Rugged steel construction. Self-closing swing door.

SPECIFY COLOR: Black, Green, Galvanized, Blue or Red

MODEL NO.	DESCRIPTION	CAPACITY (GAL.)	SIZE DIAM. x H	WT (LBS.)	PRICE EACH	
					1	3+
H-2125	Wire Mesh	45	24 x 33"	30	\$215	\$205
H-1857*	Steel Dome Lid			12	121	118
S-2055	Clear Trash Liners (100 per Carton)			21	62	60

\* Available in Black, Green, Blue or Red

■ SHIPS VIA MOTOR FREIGHT



# LANDMARK SERIES™ RECEPTACLES

RUBBERMAID®

Handsome River Rock paneled trash receptacles provide permanence and stability.

- Domed top keeps rain out. Opens easily to remove trash.
- Rugged UV-resistant plastic top lasts for years.
- Includes removable leakproof rigid trash liner.
- Ash Tray Sand available, see uline.com



DOMED TOP

SPECIFY FRAME COLOR: Brown or Black

MODEL NO.	CAPACITY (GAL.)	SIZE W x D x H	WT. (LBS.)	PRICE EACH	
				1	2+
H-3570	35	26 x 26 x 40"	81	\$820	\$800
H-1209	50	26 x 26 x 46½"	105	920	900

SHIPS UNASSEMBLED VIA MOTOR FREIGHT

ASH TRAY TOP

SPECIFY FRAME COLOR: Brown or Black

MODEL NO.	CAPACITY (GAL.)	SIZE W x D x H	WT. (LBS.)	PRICE EACH	
				1	2+
H-3571	35	26 x 26 x 40"	83	\$925	\$905
H-1210*	50	26 x 26 x 46½"	107	1,045	1,015

\* Not available in Brown

SHIPS UNASSEMBLED VIA MOTOR FREIGHT

# ULINE CANS WITH WHEELS



Rolls to the curb with ease. "Garbage man ready."

- Recessed upper lift pocket and steel lower lift bar for fully automated and semi-automated collection systems.
- Lid opens 270° on molded hinges.
- Streamlined body with easy-rolling 10" plastic wheels. 8" wheels, 35 gal.



SPECIFY COLOR: ■ Blue ■ Black ■ Green ■ Red ■ Yellow

MODEL NO.	DESCRIPTION	SIZE L x W x H	WT. (LBS.)	PRICE EACH			RECOMMENDED BAGS
				1	3	6+	
H-4202	35 Gallon	24 x 19 x 38"	22	\$100	\$95	\$90	S-15537
■H-7937	65 Gallon	27 x 27 x 44"	29	135	130	125	S-23677
■H-7938	95 Gallon	34 x 29 x 45"	33	155	150	145	S-12615

■ SHIPS VIA MOTOR FREIGHT



## BIOHAZARD CAN WITH WHEELS New

TOTER®

Safely collect and dispose of medical waste from your facility.

- Locking lid with gasket reduces odors and spills.
- Smooth interior walls are easy to clean. Polyethylene construction.
- Quiet 10" rubber wheels.



Compliant with fully automated and semi-automated collection systems.

MODEL NO.	DESCRIPTION	SIZE L x W x H	WT. (LBS.)	PRICE EACH		
				1	3	6+
H-10759	96 Gallon	30 x 36 x 44"	40	\$490	\$475	\$460

SHIPS VIA MOTOR FREIGHT



## BEAR TOUGH TRASH CAN

TOTER®

Keep out city vandals and Wisconsin bears.

- Enclosed trigger lock prevents unwanted access.
- 10" wheels roll easily over any terrain.
- Withstands repeated chewing and clawing. Heavy-duty polyethylene.



Compliant with fully automated and semi-automated collection systems.

MODEL NO.	DESCRIPTION	SIZE L x W x H	WT. (LBS.)	PRICE EACH		
				1	3	6+
H-8701	96 Gallon	36 x 30 x 44"	52	\$470	\$455	\$440

SHIPS VIA MOTOR FREIGHT



## SQUARE BRUTE® CONTAINERS

RUBBERMAID®

14% bigger. Large-capacity container fits neatly in corners and along walls.

- Heavy-duty plastic construction resists denting, bending and cracking.
- Molded-in nesting handles fit securely for side-by-side use.
- Snap-shut lid protects dry goods or seals trash. Controls odors.

H-3493

H-3492

LIDS

Sold separately, see uline.com



Square Dolly

CONTAINERS

SPECIFY COLOR: ■ Gray ■ Red

MODEL NO.	DESCRIPTION	SIZE L x W x H	WT. (LBS.)	PRICE EACH		
				1	3	5+
H-3492	28 Gallon	21 x 21 x 22"	10	\$60	\$58	\$55
H-3493	40 Gallon	23 x 23 x 29"	14	85	82	79

DOLLY

USDA compliant. NSF certified.

H-3498	Square Dolly	17 x 17 x 6"	6	\$94	\$92	\$89
--------	--------------	--------------	---	------	------	------

# RECYCLING CONTAINERS

Sturdy containers hold paper, cans and bottles for recycling.

- Tough plastic won't crack, chip or dent.



Office Cubicle



Can with Wheels

## OFFICE

- Office – For offices and cubicles.
- Slim Jim® – Fits where space is limited. Lids sold separately below.



Square

Slim Jim®

## CAFETERIAS/WORKROOMS

- Square – For cafeterias and breakrooms. Indoor/outdoor. Lid sold separately below.
- Tote Bin – For copier rooms and printer rooms.



Tilt Truck

## WAREHOUSE INDOOR/OUTDOOR

- Can with Wheels – Rolls easily over steps or curbs. Hinged lid.
- Tilt Truck – Large capacity. Easy to maneuver.
- Brute® – For high-traffic areas and large cafeterias.



Brute®



Tote Bin

\* SPECIFY COLOR: Blue or Green

MODEL NO.	DESCRIPTION	CAPACITY	WT. (LBS.)	PRICE EACH		
				1	3	6+
H-1858	Office	3 Gallon	1	N/A	\$9	\$8
H-1384*		7 Gallon	2	N/A	10	9
H-1859		10 Gallon	3	\$18	17	16
H-1385*	Slim Jim®	23 Gallon	8	\$62 each any quantity		
H-1634*	Slim Jim® Bottle Lid	23 Gallon	1	52	49	47
H-9956*	Slim Jim® Slot Lid	23 Gallon	1	52	49	47
H-2832	Square	23 Gallon	6	92	90	87
H-2179		35 Gallon	10	143	141	138
H-2834		50 Gallon	12	210	205	200
H-2180	Sq. Bottle Lid	35/50 Gallon	3	78	76	73

MODEL NO.	DESCRIPTION	CAPACITY	WT. (LBS.)	PRICE EACH		
				1	3	6+
H-2285	Tote Bin	14 Gallon	4	\$26	\$25	\$24
H-2836		18 Gallon	5	35	34	32
H-1478*	Brute®	32 Gallon	8	46	43	41
■H-1860		44 Gallon	13	70	67	65
■H-5153		55 Gallon	16	99	96	93
■H-1861*	Can w/ Wheels	50 Gallon	25	140	135	130
■H-2837		95 Gallon	39	240	230	220
■H-1862	Tilt Truck	1/2 Cubic Yd.	77	\$1,020 ea. / 2+ \$960 ea.		
■H-7929		1 Cubic Yd.	111	\$1,215 ea. / 2+ \$1,120 ea.		

■ SHIPS VIA MOTOR FREIGHT



## ULINE DRAWSTRING RECYCLING LINERS

Convenient drawstring handle makes recycling a cinch.

- Easily separate, identify and dispose of recycling materials.
- Resists punctures and tears.
- Linear low density.

MODEL NO.	DIMENSIONS W x H	CAPACITY	QTY./ CTN.	PRICE PER CARTON		
				1	3	6+
S-23036	24 x 28"	13 Gallon	400	\$70	\$68	\$66
S-23037	33 x 38"	33 Gallon	150	62	60	57





## UMBRELLAS

Take on the sunniest days with these big, wide umbrellas.

- Opens to 9 ft. wide. Fits tables with 1½" center hole.
- Durable spun polyester fabric resists fading and mildew.



Under-Table

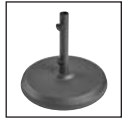

Stand-Alone

**Under-Table Base** – Slim, lightweight design.

**Stand-Alone Base** – Heavyweight base stabilizes umbrella.

\* SPECIFY COLOR: Red, Blue, Green, Beige or Black

MODEL NO.	DESCRIPTION	SIZE L x W x H	WT. (LBS.)	PRICE EACH	
				1	3+
H-8158*	Umbrella	108 x 108 x 102"	14	\$199	\$195
H-8160	Under-Table Umbrella Base	18 x 18 x 18"	35	99	95
H-8159	Stand-Alone Umbrella Base	20 x 20 x 21"	50	150	145



## ADA METAL PICNIC TABLES

Modified benches provide wheelchair access.

- Round and square have one less bench. Rectangle has shorter benches.
- Thermoplastic coating withstands heat, cold and the elements.



SPECIFY COLOR: Blue Red Brown Green Black Burgundy Gray Navy Orange Beige

MODEL NO.	DESCRIPTION	SIZE L x W x H	WT. (LBS.)	PRICE EACH	
				1	3+
H-2671	46" ADA Square	80 x 80 x 31"	180	\$1,180	\$1,130
H-2672	46" ADA Round	81 x 81 x 31"	160	1,200	1,150
H-2673	8' ADA Rectangle	96 x 61 x 31"	160	1,200	1,150

DROP SHIPS FROM NC UNASSEMBLED VIA MOTOR FREIGHT



## COMPOSITE PICNIC TABLES

Surprisingly comfortable. Lightweight composite material lasts forever.

- Natural-looking wood grain planks never need sealing or painting.
- 14-gauge, powder-coated steel frame. Matte black.

SPECIFY COLOR: Gray Brown

MODEL NO.	DESCRIPTION	SIZE L x W x H	WT. (LBS.)	PRICE EACH	
				1	3+
H-9130	6' Rectangle Table	72 x 62 x 29"	200	\$920	\$895

SHIPS UNASSEMBLED VIA MOTOR FREIGHT

## THERMOPLASTIC RECEPTACLES



IN STOCK – SHIPS TODAY

Guaranteed to be the last can you'll ever need to buy.

- Heavy-duty, 9-gauge expanded metal. Rust free.
- Large 9½" opening. Lid cable attachment included.
- Reusable liner. Easy to empty, easy to clean.

**H-2293** – Funnel lid slopes inward to keep trash off the lid.

**H-5154** – Bonnet lid keeps out rain and snow.



BONNET LID



SPECIFY COLOR: Blue Red Green Black Gray

MODEL NO.	DESCRIPTION	SIZE DIAM. x H	CAP. (GAL.)	WT. (LBS.)	PRICE EACH	
					1	3+
H-2293	Funnel Lid	24 x 29"	50	\$550	\$530	
H-5154	Bonnet Lid	24 x 37"	32	53	585 565	

SHIPS VIA MOTOR FREIGHT

# OUTDOOR FURNITURE



ROUND



SQUARE

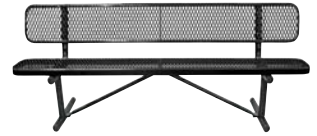

BENCH WITH BACK



6' RECTANGLE



BENCH WITHOUT BACK



8' RECTANGLE



INGROUND MOUNT

Uline loves these! Attractive, rugged and built to last. Give your corporate office patio an upscale look.

- Thermoplastic coating withstands heat, cold and all weather elements. Rust free.
- High gloss, smooth surface allows for easy spray paint and graffiti removal.
- 9-gauge expanded metal with 2" black steel frame.
- Rounded corners for added safety.
- ADA models, see page 406.

**Inground Mount Furniture** – Permanently anchor in ground. Secure with concrete. See [uline.com](http://uline.com)



BROWN



BURGUNDY

AVAILABLE IN 10 HOT COLORS!



## TABLES

MODEL NO.	DESCRIPTION	SIZE L x W x H	WT. (LBS.)	PRICE EACH	
				1	3+
H-2126	46" Square	80 x 80 x 31"	185	\$1,200	\$1,150
H-2127	46" Round	81 x 81 x 31"	175	1,220	1,170
H-2128	6' Rectangle	72 x 61 x 31"	145	1,150	1,100
H-2129	8' Rectangle	96 x 61 x 31"	170	1,220	1,170
H-2672	46" ADA Round	81 x 81 x 31"	160	1,200	1,150

DROP SHIPS FROM NC UNASSEMBLED VIA MOTOR FREIGHT

## BENCHES

H-3500	4' Bench with Back	48 x 12 x 31"	76	\$535	\$515
H-3501	4' Bench without Back	48 x 12 x 18"	41	405	390
H-2294	6' Bench with Back	72 x 12 x 31"	98	645	620
H-2295	6' Bench without Back	72 x 12 x 18"	52	460	445
H-3502	8' Bench with Back	96 x 12 x 31"	120	740	720
H-3503	8' Bench without Back	96 x 12 x 18"	63	515	495

DROP SHIPS FROM NC UNASSEMBLED VIA MOTOR FREIGHT





# WOODEN PICNIC TABLES



ECONOMY

All-American classic. For parks, walking paths and picnic areas. Made in the USA.

- Pressure-treated 2 x 6" pine boards resist termites, fungus and rot.
- Rust-resistant hardware included.

**Deluxe** – No splintering or rough edges. Pre-sanded finish. Easily paint or stain.



DELUXE

## ECONOMY

MODEL NO.	DESCRIPTION	SIZE L x W x H	WT. (LBS.)	PRICE EACH	
				1	5+
H-2999	6' A-Frame	72 x 59 x 28"	180	\$219 each	
H-5163	8' A-Frame	95 x 59 x 28"	226	\$369	\$349

SHIPS UNASSEMBLED VIA MOTOR FREIGHT

## DELUXE

MODEL NO.	DESCRIPTION	SIZE L x W x H	WT. (LBS.)	PRICE EACH	
				1	5+
H-6102	6' A-Frame	72 x 59 x 28"	185	\$379	\$359
H-6577	8' A-Frame	95 x 59 x 28"	246	449	429

SHIPS UNASSEMBLED VIA MOTOR FREIGHT

# STEEL FRAME PICNIC TABLES



Replacement planks available, see uline.com

## WOOD

Heavy-duty beast! Tough enough for camps and shelters.

- Pressure-treated 2 x 10" pine boards resist termites, fungus and rot.
- 2<sup>3</sup>/<sub>8</sub>" galvanized steel frame.

- Choose from pressure-treated or attractive redwood stained pine. Mounting hardware included.

## WOOD

Pressure-Treated  Stained

MODEL NO.	DESCRIPTION	SIZE L x W x H	WT. (LBS.)	PRICE EACH	
				1	3+
H-4405	6' Pressure-Treated	72 x 60 x 29"	240	\$595	\$575
H-6578	6' Stained			635	615

SHIPS UNASSEMBLED VIA MOTOR FREIGHT

## RECYCLED PLASTIC

Lasts forever. For city parks and outdoor venues.

- UV-protected plastic planks never need sealing, painting or staining.
- 2<sup>3</sup>/<sub>8</sub>" galvanized steel frame. Planks won't warp, crack or splinter.
- Withstands the harshest weather. Most graffiti cleans right off. Mounting hardware included.



MAINTENANCE FREE

## RECYCLED PLASTIC

SPECIFY COLOR:  Cedar  Brown

MODEL NO.	DESCRIPTION	SIZE L x W x H	WT. (LBS.)	PRICE EACH	
				1	3+
H-5870	6' Recycled	72 x 60 x 29"	230	\$1,225	\$1,175

DROP SHIPS FROM KS UNASSEMBLED VIA MOTOR FREIGHT

# ALUMINUM PICNIC TABLE



Benches available, see uline.com

Nearly indestructible! For use at schools and visitor centers.

- 2 x 10" anodized aluminum tabletop and seat planks.
- 2<sup>3</sup>/<sub>8</sub>" galvanized steel frame. Planks won't corrode or rust.

- Withstands corrosive environments. Incredibly strong.

Mounting hardware, see uline.com

MODEL NO.	DESCRIPTION	SIZE L x W x H	WT. (LBS.)	PRICE EACH	
				1	3+
H-3745	6' Aluminum	72 x 62 x 32"	185	\$1,250	\$1,200

SHIPS UNASSEMBLED VIA MOTOR FREIGHT

# FOLDING PICNIC TABLE

Three-season seating. Stores easily when the temps drop.

- Folds to 4" thickness for convenient storage and transport.
- Low-maintenance polyethylene with powder-coated steel frame.
- UV protected. Weather, stain and rust resistant.



SPECIFY COLOR:  Brown  Gray

MODEL NO.	DESCRIPTION	SIZE L x W x H	WT. (LBS.)	PRICE EACH	
				1	3+
H-9417	6' Folding	72 x 57 x 29"	83	\$320	\$305

SHIPS UNASSEMBLED VIA MOTOR FREIGHT



# RECYCLED OUTDOOR FURNITURE



HEX



RECTANGLE



BENCH WITH BACK



A-FRAME



BENCH WITHOUT BACK

Virtually maintenance free! Recommended for warehouse patios, campgrounds, schools and parks.

- 100% recycled UV-protected plastic won't rot, splinter or crack. Withstands harsh weather.
- Natural-looking wood material never needs sanding, sealing, painting or staining.
- Durable 2" thick planks pre-drilled for easy assembly.
- Mounting hardware, see [uline.com](http://uline.com)



**Benches** – Comfortable and durable. Use same mounting hardware as rectangle tables.

**Receptacles** – Include molded plastic lid with 11" opening.

## PICNIC TABLES

SPECIFY COLOR: Cedar Gray Brown Green

MODEL NO.	DESCRIPTION	SIZE L x W x H	WT. (LBS.)	PRICE EACH	
				1	3+
H-2560	46" Hex	72 x 72 x 30"	250	\$1,295	\$1,245
H-2561	6' Rectangle	72 x 61 x 30"	310	1,225	1,175
H-2562	8' Rectangle	96 x 61 x 30"	350	1,345	1,295
H-2563	6' A-Frame	72 x 61 x 30"	260	1,275	1,225
H-2564	8' A-Frame	96 x 61 x 30"	350	1,420	1,370

DROP SHIPS FROM KS UNASSEMBLED VIA MOTOR FREIGHT

## BENCHES

MODEL NO.	DESCRIPTION	SIZE L x W x H	WT. (LBS.)	PRICE EACH	
				1	3+
H-7941	4' with Back	48 x 25 x 34"	110	\$575	\$550
H-2887	6' without Back	72 x 23 x 18"	115	470	450
H-2888	6' with Back	72 x 25 x 34"	160	750	715
H-7942	8' with Back	96 x 25 x 34"	215	935	900

DROP SHIPS FROM KS UNASSEMBLED VIA MOTOR FREIGHT

## RECEPTACLES

MODEL NO.	DESCRIPTION	SIZE DIAMETER x H	WT. (LBS.)	PRICE EACH	
				1	3+
H-2889	32 Gallon	30 x 33"	79	\$575	\$555

SHIPS UNASSEMBLED VIA MOTOR FREIGHT

## MANY STYLES TO CHOOSE FROM:



A-Frame: Classic picnic table style.



Hex: Best-selling table.



## LAGUNA BENCHES



Comfy Contoured Seat

Maximum comfort for bistros, boardwalks and beaches with contoured seat and backrest.

- 100% recycled UV-protected plastic with concealed hardware.
- Withstands daily exposure to sun and salt water. Won't rot, splinter or crack.
- Center legs prevent sagging.

SPECIFY COLOR: Cedar Gray Brown

MODEL NO.	DESCRIPTION	SIZE L x W x H	WT. (LBS.)	PRICE EACH	
				1	3+
H-6570	6' Laguna	72 x 29 x 33"	139	\$660	\$615
H-8675	8' Laguna	96 x 29 x 33"	165	770	725

DROP SHIPS FROM KS UNASSEMBLED VIA MOTOR FREIGHT



Carry a roll wherever you go – on the job site, tailgating or backyard BBQ.

- Handles heavy items and sharp corners without tearing.
- Roll packed bags in a dispenser box. Star seal bottom.

SPECIFY COLOR: Black or Clear

MODEL NO.	SIZE W x H	CAPACITY	MIL	STRENGTH	QTY./CTN.	LBS./CTN.	PRICE PER CARTON			
							1	3	6+	
S-23688	33 x 41"	33 Gallon	1.5	Heavy	250	34	\$99	\$97	\$95	
S-21329	40 x 46"	40-45 Gallon	1.5		100	19	21	59	57	55
S-21330	36 x 58"	44-55 Gallon						61	59	57
S-21331	39 x 58"	55-60 Gallon	1.5	Heavy	100	23	68	66	64	
S-21332			2				89	87	85	
S-23689	44 x 55"	65 Gallon	2				80	26	81	79



## CAFÉ SEATING

Sturdy, attractive seating for your outdoor cafés, bistros and office patios.

- Steel mesh prevents standing water and makes cleanup easy.
- Unusually comfy. Extra wide and roomy.
- Low-maintenance, black powder-coat finish.
- Table accommodates 1½" diameter umbrella.

MODEL NO.	DESCRIPTION	SIZE W x L x H	WT. (LBS.)	PRICE EACH	
				1	4+
H-7235	36" Square Table	36 x 36 x 29"	26	\$270	\$260
H-7236	36" Round Table		24		
■H-7915	48" Round Table	48 x 48 x 29"	31	320	300

MODEL NO.	DESCRIPTION	SIZE W x L x H	WT. (LBS.)	PRICE PER CHAIR	
				4	8+
■H-7237	Stacking Chair	23 x 25 x 35"	12	<b>\$90 each</b>	

■ SHIPS VIA MOTOR FREIGHT



## PATIO SEATING

Contemporary, comfortable seating for wineries, restaurants and rooftop patios.

- Withstands the harshest weather.
- Stylish, synthetic wood won't fade, peel or crack.
- Powder-coated steel frame.
- Chairs are stackable for easy storage.

MODEL NO.	DESCRIPTION	SIZE W x L x H	WT. (LBS.)	PRICE EACH	
				1	4+
H-8590	34" Square Table	34 x 34 x 29"	43	\$300	\$275
■H-8591	46" Square Table	46 x 46 x 29"	61	375	350

MODEL NO.	DESCRIPTION	SIZE W x L x H	WT. (LBS.)	PRICE PER CHAIR	
				4	8+
■H-8592	Stacking Chair	23 x 20 x 35"	21	<b>\$95 each</b>	

■ SHIPS VIA MOTOR FREIGHT



## PATIO HEATERS

Extend your outdoor seating season with cozy, portable warmth.

- Bronze powder-coated steel base. Stainless steel top.
- Automatic shut-off if tipped over.

**Patio** – Heats 175 sq. ft. with 20 lb. propane tank. Includes height-adjustable table.

**Tabletop** – Heats 30 sq. ft. with 1 lb. propane cylinder.

For outdoor use. Propane tank not included. SHIPS UNASSEMBLED VIA UPS

MODEL NO.	DESCRIPTION	DIMENSIONS W x D x H	BTU	WT. (LBS.)	PRICE EACH	
					1	3+
H-5839	Patio	33 x 33 x 87"	41,000	40	\$219	\$199
H-5221	Tabletop	13 x 21 x 38"	11,000	17	<b>\$130 each</b>	



TABLETOP

### FREE OFFER

Free Tabletop Heater upon request with any Uline order of \$2,500 or more.

## TERRACE RECEPTACLES



A beauty and a beast. Heavy-duty slatted steel with chiseled good looks.

- For schools, parks and corporate campuses.
- Side-door access for easy trash removal.
- Weather-resistant, powder-coated finish.
- Includes built-in rain bonnet and plastic liner.

SPECIFY COLOR:  Gray  Black  Beige

MODEL NO.	DESCRIPTION	CAP. (GAL.)	SIZE L x W x H	WT. (LBS.)	PRICE EACH	
					1	2+
H-7234	Terrace	32	26 x 28 x 38"	171	\$1,075	\$1,050

EASY ASSEMBLY. SHIPS VIA MOTOR FREIGHT.

## COURTYARD RECEPTACLES

An attractive, vandal-proof hideaway for trash.

- For parks, offices and city streets.
- Slatted steel bars deter vandalism.
- Weather and rust-resistant, powder-coated finish.
- Includes Black Plastic Liner and Anchor Kit.



MODEL NO.	DESCRIPTION	CAP. (GAL.)	SIZE DIAM. x H	WT. (LBS.)	PRICE EACH	
					1	2+
H-2865	Flat Lid	36	28 x 36"	93	\$755	\$725
H-5171	Bonnet Lid			96	830	800

SHIPS ASSEMBLED VIA MOTOR FREIGHT

## TERRACE BENCHES



Strength and style for office parks and streetscapes.

- Comfortable, contoured seat and armrests.
- Weather-resistant, thermoplastic finish.
- Heavy-duty slatted steel construction.

Bench mounting hardware included



SPECIFY COLOR:  Gray  Black  Beige

MODEL NO.	DESCRIPTION	SIZE L x W x H	WT. (LBS.)	PRICE EACH	
				1	2+
H-7930	6' Bench with Back	72 x 25 x 37"	150	\$1,130	\$1,075

DROP SHIPS FROM NC ASSEMBLED VIA MOTOR FREIGHT

## COURTYARD BENCHES

An elegant choice for hotels and shopping centers.

- Smooth, comfortable seat and armrests.
- Glossy weather-resistant, powder-coated finish.
- Durable, heavy-duty steel bar construction.



Coordinating Planter and Bench Mounting Hardware sold separately, see uline.com



MODEL NO.	DESCRIPTION	SIZE L x W x H	WT. (LBS.)	PRICE EACH	
				1	3+
H-3019	6' Bench without Back	71 x 21 x 25"	192	\$1,045	\$1,010
H-3018	6' Bench with Back	71 x 26 x 32"	253	1,315	1,270

DROP SHIPS FROM WI ASSEMBLED VIA MOTOR FREIGHT

## WAVE BIKE RACKS



Upscale stylish look. Easy to secure your bike.

- For stadiums, parks and athletic fields.
- 10-gauge galvanized steel or attractive powder coating.
- 2 $\frac{3}{8}$ " diameter bar.

Mounting hardware included

SPECIFY COLOR:  Galvanized  Black  Green

MODEL NO.	DESCRIPTION	SIZE L x W x H	BIKE CAPACITY	WT. (LBS.)	PRICE EACH	
					1	3+
H-2892*	1-Loop	22 x 2 $\frac{1}{2}$ x 34"	3	27	\$230	\$220
■H-2543	3-Loop	43 x 2 $\frac{1}{2}$ x 39"	5	56	395	375
■H-2544	5-Loop	68 x 2 $\frac{1}{2}$ x 39"	7	80	515	495

\* Galvanized and Black only

■ SHIPS VIA MOTOR FREIGHT

## GRID BIKE RACKS

Everybody's biking! Secures bikes, deters theft.

- For commuter stations, libraries and schools.
- Sturdy 14-gauge galvanized steel or attractive powder coating.



Mounting hardware included

SPECIFY COLOR:  Galvanized  Black

MODEL NO.	DESCRIPTION	SIZE L x W x H	BIKE CAPACITY	WT. (LBS.)	PRICE EACH	
					1	3+
H-2890	Single-Sided	48 x 31 x 31"	4	48	\$350	\$330
■H-2891		110 x 31 x 31"	9	78	550	520
H-2540	Double-Sided	48 x 36 x 31"	8	61	395	375
■H-2541		110 x 36 x 31"	18	112	650	620

SHIPS UNASSEMBLED

■ SHIPS VIA MOTOR FREIGHT





## DOG WASTE SYSTEM

Keeps apartment landscaping, hiking trails, dog parks and recreation areas free of dog waste.

**Sign** – Large, easy-to-read reflective aluminum.

**Dispenser** – Tough, powder-coated aluminum. Locking front panel. Includes 400 bags.

**Receptacle** – 18-gauge steel. Includes retainer band. 10-gallon capacity.

### BAGS

Your neighbor's best friend. Used everywhere.



### WASTE SYSTEM

▲ SPECIFY COLOR: Green or Galvanized

MODEL NO.	DESCRIPTION	SIZE L x W x H	WT. (LBS.)	PRICE EACH	
				1	3+
H-2898*	Sign	12 x 18"	2	\$34	\$32
H-2897*	Dispenser	9 x 3 x 16"	7	142	137
H-3491*	Receptacle	11.5" Diam. x 23" H	16	215	205
■H-1662▲	8 ft. U-Channel Post			42	40

\* Mounting hardware included

■ SHIPS VIA MOTOR FREIGHT

### BAGS

MODEL NO.	DESCRIPTION	SIZE	QTY./ BOX	BOXES/ CTN.	PRICE/CTN.	
					1	3+
S-21319	Uline				\$55 any qty.	
S-15585	Dogipot®	8 x 13"	200	10	\$98	\$84
S-20825	Recp. Liner	28 x 29"	50	4	111	95

## BAYSHORE PATIO SEATING



Cool, casual seating for breweries, resorts and waterfront restaurants.

- Strong, long-lasting aluminum stands up to the elements.
- Low-maintenance, silver powder-coat finish.
- Table fits 1 1/2" diameter umbrella.

**Patio Chairs** – Metro, industrial style. Use indoors or out. Recommended for craft distilleries, wineries and rooftop lounges.



SIDE CHAIR

ARM CHAIR

SHIPS VIA MOTOR FREIGHT

### SPECIAL OFFER

SHIPS VIA MOTOR FREIGHT

MODEL NO.	DESCRIPTION	REG. PRICE	SPECIAL PRICE
H-10779	Table and 4 Side Chairs	<del>\$975</del>	\$800
H-10780	Table and 4 Arm Chairs	<del>1,015</del>	830

MODEL NO.	DESCRIPTION	SIZE W x L x H	WT. (LBS.)	PRICE EACH	
				1	4+
H-9120	Rectangle Table	32 x 46 x 30"	63	\$395	\$370
MODEL NO.	DESCRIPTION	SIZE W x L x H	WT. (LBS.)	PRICE PER CHAIR	
				4	8+
H-9121	Side Chair	22 x 22 x 33"	11	\$145	\$130
H-9122	Arm Chair	24 x 22 x 33"		155	140

## ADIRONDACK CHAIRS New



Sit back, relax and enjoy the view. Recommended for hotels, resorts and corporate patios.

- 100% UV-protected, recycled plastic won't fade, rot or crack.
- Maintenance-free. Never needs painting, sanding or sealing.

SPECIFY COLOR: ■ Red ■ Brown ■ Gray

MODEL NO.	DESCRIPTION	SIZE L x W x H	CAP. (LBS.)	WT. (LBS.)	PRICE EACH	
					1	2+
H-10778	Adirondack Chair	33 x 30 x 36"	325	34	\$295	\$285

EASY ASSEMBLY. SHIPS VIA UPS.

## CONVERTIBLE BENCH

Very comfortable bench! Allows you to prepare for picnics with a quick pull of a lever.

- UV-protected polystyrene planks won't fade or rot.
- Powder-coated steel frame.
- Easy one-man operation.



Two benches create a picnic table

MODEL NO.	DESCRIPTION	SIZE L x W x H	WT. (LBS.)	PRICE PER BENCH	
				1	3+
H-5947	56" Convertible	56 x 32 x 36"	73	\$289	\$279

SHIPS UNASSEMBLED VIA UPS

# ULINE DOG WASTE SYSTEM

Attractive, low maintenance, vandal-proof choice for parks and recreation areas.

- Recycled plastic won't rot, crack or corrode.

**Sign** – Reminds owners to clean up after Fido.

**Dispenser** – Locking top prevents theft. Holds 2 boxes of bags.

**Receptacle** – Easy-to-open lid is secured with cable. Includes rigid plastic liner. 10-gallon capacity.



## SYSTEM

MODEL NO.	DESCRIPTION	SIZE L x W x H	WT. (LBS.)	PRICE EACH	
				1	3+
H-5942	Sign	12 x 18"	2	\$30	\$28
H-5943*	Dispenser	9 x 5 x 12"	7	185	175
H-5944*	Receptacle	17" Diam. x 19" H	19	460	435
H-5945	7 ft. Recycled Plastic Post		25	170	165

## WASTE BAGS

MODEL NO.	STYLE	QTY./CTN.	PRICE/CTN.	
			1	3+
S-21319	Uline	2,000	\$55 any qty.	
S-15585	Dogipol®		\$98	\$84

## RECEPTACLE LINER BAGS

MODEL NO.	STYLE	QTY.	PRICE
S-20825	Liner	200	\$111   \$95

\* Mounting hardware included

## RECYCLED PLASTIC RECEPTACLES

Virtually maintenance free! Recommended for warehouse patios, campgrounds, schools and parks.

- 100% recycled UV-protected plastic won't rot, splinter or crack. Withstands harsh weather.
- Natural-looking wood material never needs sanding, sealing, painting or staining.
- Durable planks pre-drilled for easy assembly.



SPECIFY COLOR: Cedar, Gray, Brown or Green

MODEL NO.	DESCRIPTION	CAPACITY	SIZE DIAM. x H	WT. (LBS.)	PRICE EACH	
					1	3+
H-2889	Single	32 Gallon	30 x 33"	79	\$575	\$555

SHIPS UNASSEMBLED VIA MOTOR FREIGHT

## PLAZA BENCHES



H-8720

Sturdy and durable. For schools and recreational areas.

- Recycled plastic planks never need sealing, painting or staining.
- Smooth, contoured seat and backrest.
- Rust resistant, powder-coated aluminum frame.

Mounting hardware included

SPECIFY COLOR: Cedar Gray Brown

MODEL NO.	DESCRIPTION	SIZE L x W x H	WT. (LBS.)	PRICE EACH	
				1	3+
H-4337*	6' Metal Frame	72 x 24 x 30"	150	\$1,055	\$1,020
H-8720	8' Metal Frame	96 x 24 x 30"	210	1,450	1,395

\* Also available in Green

■ SHIPS UNASSEMBLED VIA MOTOR FREIGHT

## MESSAGE CENTERS

Post instructions, directories or maps at parks or on camp trails.

- Shatterproof, clear plastic windows with lock.
- Thick 1/4" corkboard.
- Recycled plastic frame and posts are weather and graffiti resistant.



Posts included

SPECIFY COLOR: Cedar Brown Green

MODEL NO.	DESCRIPTION	SIZE L x W x H	WT. (LBS.)	PRICE EACH	
				1	3+
H-7975	Trail Sign	20 x 4 x 100"	70	\$590	\$570
H-2857	Message Center	43 x 6 x 100"	124	880	855

■ SHIPS VIA MOTOR FREIGHT





H-9235 with optional Side Walls

## EVENT TENTS

MADE IN THE USA

Worth the investment. Use year after year for outdoor events, dining and checking in at schools.

- Premium vinyl canopy top is UV, fire and water resistant.
- Strong, anodized aluminum frame with 2" diameter poles.
- Secure tents into grass with included stakes and ratchet straps.
- Barrels for anchoring on concrete, see [uline.com](http://uline.com)



### EVENT TENT WITH STAKES

MODEL NO.	DESCRIPTION	SIZE L x W	SIDE HEIGHT	PEAK HEIGHT	WT. (LBS.)	PRICE EACH
H-9234	48 person	20 x 20'			465	\$3,925
H-9235	64 person	20 x 30'	7'	12'	583	5,025
H-9236	96 person	20 x 40'			750	6,075

DROP SHIPS FROM WI VIA MOTOR FREIGHT

### OPTIONAL SIDE WALLS

DESCRIPTION	LENGTH	WT. (LBS.)	SOLID		WINDOW	
			MODEL NO.	PRICE EACH	MODEL NO.	PRICE EACH
Side Walls	20'	18	H-9237	\$265	H-9238	\$340
	30'	27	H-9240	335	H-9241	490
	40'	36	H-9243	430	H-9244	660

DROP SHIPS FROM WI VIA MOTOR FREIGHT



## INDUSTRIAL METAL STOOLS

Retro-inspired seating for restaurants, bars and patio dining.

- Galvanized steel with durable powder-coat finish.
- Cross bracing under seat adds strength and support.
- Stools are stackable for easy storage. Rubber feet protect floors.



Counter Height



Bar Height

SPECIFY COLOR: Red, Silver, Black, Yellow or White

MODEL NO.	DESCRIPTION	SEAT HEIGHT	CAP. (LBS.)	QTY./CTN.	PRICE PER CHAIR (MIN. 4)	
					4	16+
H-10722	Counter Height	24"	400	4	\$58	\$53
H-9103	Bar Height	30"			60	55

SHIPS VIA UPS

SOLD IN CARTON QUANTITIES



## AMERICAN FLAGS

Proudly display your patriotism! Indoors or out.

- Heavy 200 denier nylon: Sheds rain, dries quickly. Waves easily in light winds and breezes. Resists UV and mildew.
- Heavy-duty lockstitching, canvas header and brass grommets.

See [uline.com](http://uline.com) for Canada and Mexico

MODEL NO.	FLAG SIZE H x W	RECOMMENDED POLE HEIGHT	WT. (LBS.)	PRICE EACH	
				1	3+
S-16065	4 x 6'	25'	1	\$56	\$53
S-16066	5 x 8'	30'	2	81	76
S-16067	6 x 10'	35'	3	114	109



## DELUXE SHELTER

Keep the sun, rain and leaves off your vehicles and equipment.

- Polyethylene cover is flame, UV and water resistant.
- Fast, easy setup. Heavy-duty, 19-gauge powder-coated steel frame.

Optional Side Walls – Attach easily to shelter. Includes 2' windows and roll-up door at one end.

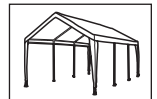

MODEL NO.	DESCRIPTION	SIZE L x W	MAX. SIDE HEIGHT	PEAK HEIGHT	WT. (LBS.)	PRICE EACH		SIDE WALL KIT	
						1	3+	MODEL NO.	PRICE
H-8667	Steel Frame	20 x 10'	6' 8"	9' 9"	155	\$445	\$425	H-8668	\$175

SHIPS UNASSEMBLED VIA MOTOR FREIGHT



# INSTANT CANOPIES

Provide instant shade and shelter. Sets up in minutes.

- Polyester covers are flame, UV and water resistant.
- Stakes anchor to the ground for added stability.
- 5 height adjustments. • Conveniently store in bag with wheels.

**Steel Frame** – Temporary shade for tailgating and picnics.

**Aluminum Frame** – Lighter and stronger than steel.  
For company events and street fairs.



**CANOPIES** \* SPECIFY COLOR:  White  Black  Blue  Green  Red

MODEL NO.	DESCRIPTION	SIZE L x W	COLOR	MAX. SIDE HEIGHT	PEAK HEIGHT	WT. (LBS.)	PRICE EACH	
							1	3+
H-9105	Steel Frame	5 x 5'	White	7'	10'	40	\$220	\$210
H-9106	Aluminum Frame						290	270
H-2674	Steel Frame	10 x 10'	Specify*	7'	10'	61	250	240
H-2675	Aluminum Frame						340	320
■H-9107	Steel Frame	10 x 15'	White	7'	10'	79	340	320
■H-9108	Aluminum Frame						425	405
■H-7266	Steel Frame	10 x 20'	White, Black or Blue	7'	10'	110	435	405
■H-7265	Aluminum Frame						515	485

**Optional Side Walls** – Attach easily to canopy frame for added protection from wind and sun.

**Mesh** – Keep insects out while allowing air to circulate.

**Window** – Windows on 4 sides for added light and visibility.

**Clear** – Maximum visibility. Ultra clear.

■ SHIPS VIA MOTOR FREIGHT

**CANOPY SIDE WALLS** \* SPECIFY COLOR:  White  Black  Blue  Green  Red

MODEL NO.	DESCRIPTION	FITS CANOPY SIZE	COLOR	QTY./ CTN.	WT. (LBS.)	PRICE PER CTN.	
						1	3+
H-9112	Solid Walls	5 x 5'	White	4 Walls	4	\$75	\$70
H-2676	Solid Walls	10 x 10'	Specify*	4 Walls	8	85	80
H-8896	Mesh Walls		White		5	115	110
H-8897	Window Walls		White		11	140	135
H-8898	Clear Walls		Clear		15	160	155
H-9113	Solid Walls	10 x 15'	White	4 Walls	10	100	95
H-7267	Solid Walls	10 x 20'	White, Black or Blue	6 Walls	17	130	125



## CANOPY WEIGHTS

MODEL NO.	DESCRIPTION	QTY./ CTN.	WT. (LBS.)	PRICE PER CTN.	
				1	3+
H-9109	Canopy Weight Bags	4	3	\$29	\$27
H-8015	Canopy Weight Discs		40	41	39



**Canopy Weights** – Anchor your canopy on windy days.

**Bags** – Fill with up to 35 lbs. of sand, dirt or rocks.

**Discs** – 10 lb. weights slide onto canopy legs.

# ALUMINUM BLEACHERS



Get the crowd into the game with comfortable seating and elevated views.

- 10" deep aluminum benches and foot rails.
- Welded aluminum frame. No rust.

ASSEMBLY REQUIRED

SHIPS VIA MOTOR FREIGHT

MODEL NO.	DESCRIPTION	SEATING CAPACITY	SIZE L x W x H	WT. (LBS.)	PRICE EACH	
					1	3+
H-7229	3 Rows	15	7.5 x 5 x 2'	150	\$1,115	\$1,075
H-4406	3 Rows	30	15 x 5 x 2'	186	1,940	1,890
H-4407*	4 Rows	40	15 x 7 x 2.5'	316	2,410	2,345

\* DROP SHIPS FROM FL UNASSEMBLED VIA MOTOR FREIGHT

# HI-VIS CANOPIES



Protect construction workers from vehicles and equipment on busy job sites.

- Aluminum frame with flame, UV and water-resistant polyester cover.
- Stakes anchor to the ground for added stability.
- Conveniently store in bag with wheels.
- Optional Side Walls and Canopy Weights, see [uline.com](http://uline.com)



SPECIFY COLOR: Orange or Lime Green

MODEL NO.	DESCRIPTION	SIZE	MAX. SIDE HEIGHT	PEAK HEIGHT	WT. (LBS.)	PRICE EACH	
						1	3+
H-7230	Instant Canopy	10 x 10'	7'	10'	50	\$350	\$330

# HI-VIS OUTDOOR CROWD CONTROL



Provide safety around work zones and construction hazards.

- 4" reflective collars are easy to see in low light conditions.
- Rustproof stainless steel post unscrews from base for storage.
- 2" wide self-retracting universal belt.
- Durable rubber base.



MODEL NO.	DESCRIPTION	HT.	BELT LENGTH	POST DIAM.	BASE DIAM.	WT. (LBS.)	PRICE/CTN. OF 2	
							1	5+
H-8655	Lime Post with Lime Belt	40"	16'	3"	19"	43	\$360	\$350
H-8654	Orange Post with Orange/White Belt							

# HI-VIS TRASH CANS



Industrial strength. Uline value. Recommended for job sites, schools and outdoor events.

- All plastic. Won't dent or crack.
- Built-in handles for easy lifting.
- Nestable when empty.

SPECIFY COLOR: Orange or Lime Green

MODEL NO.	DESCRIPTION	SIZE	WT. (LBS.)	PRICE EACH		
				1	3	5+
H-3687	Trash Can	32 Gallon	8	\$33 each any quantity		
■H-3688		44 Gallon	14	\$52	\$50	\$48
■H-3689		55 Gallon	18	\$74 each any quantity		

■ SHIPS VIA MOTOR FREIGHT

# HAND WASH STATION



Let's roll! Mobile stations for washing at construction sites, warehouses and day cares.

- Easy to maneuver tilt-and-go design.
- Foot pump for hygienic hands-free operation.
- Holds 16 gallons of fresh water for 300 washes.
- Stores 19 gallons of used water – includes drain hose.

MODEL NO.	DESCRIPTION	SIZE H x W x D	WT. (LBS.)	PRICE EACH	
				1	3+
H-8883	Hand Wash Station	62 x 18 x 22"	49	\$710	\$685

SHIPS ASSEMBLED VIA MOTOR FREIGHT

# PEDESTAL MISTING FAN

Beat the heat at outdoor festivals, parks and pavilions.

- Connect to garden hose for continuous water supply. No tank to refill.
- Use fan with or without mist.
- 10' cord with GFCI plug. 115 Volts.
- Tilting head. 3 aluminum blades.



MODEL NO.	DIMENSIONS W x H x D	FAN SIZE	HP	CFM	WT. (LBS.)	PRICE EACH	
						1	3+
H-8549	36 x 68 x 30"	30"	1/4	8,800	80	\$975	\$945

EASY ASSEMBLY. SHIPS VIA MOTOR FREIGHT.



## TRASH PICKERS



Make trash cleanup easy on your back.

**Standard** – Rubber grippers.

**Deluxe** – Magnetic tip. Nifty Nabber® Trigger Grip with 360° rotating head.

**Pro** – Extra-long 92" reach for trees and gutters.

MODEL NO.	DESCRIPTION	GRIPPER CAPACITY	PRICE EACH	
			1	3+
H-1863	32" Standard	5 lbs.	\$23	\$22
H-2896	36" Deluxe	10 lbs.	39	37
H-6579	92" Pro	10 lbs.	105	99

## LAWN/LEAF BAGS

Collect lawn clippings, leaves and yard waste.

- Self-standing sturdy bags.
- Holds up to 50 lbs.
- Heavy-duty 2-ply kraft paper.
- Moisture resistant.



MODEL NO.	DESC.	SIZE W x D x H	CAPACITY	QTY./CTN.	PRICE/CARTON	
					1	6+
S-13523	Printed	16 x 12 x 35"	30 Gallon	60	\$55	\$53
S-22522	No Print					

## PRESSURE WASHER



Delivers intense cleaning power. Easily rolls up to any job site.

- Reliable 212cc Mi-T-M® engine.
- Use outdoors. Cold water. Requires 3/4" garden hose.
- 10" pneumatic rubber wheels.
- More information, see [uline.com](http://uline.com)

ETL Listed

MODEL NO.	DESCRIPTION	PSI	GAL./MIN.	HP	WT. (LBS.)	PRICE EACH
H-7358	Industrial Gas	3,000	2.4	6.5	75	\$750

SHIPS VIA MOTOR FREIGHT

## TOOL RACKS

Cannot beat this product. Organize and consolidate your tool area.

- Angled. Keeps tools in place.
- Heavy duty steel tubing. 1 1/2" width between tubing.

**H-3782** – 3" width.

Mounting hardware not included



MODEL NO.	DESCRIPTION	DIMENSIONS L x W x H	WT. (LBS.)	PRICE EACH		
				1	3	6+
H-3781	Standard	12 x 4 x 5"	2	\$28	\$27	\$26
H-3782	Wide	12 x 5 x 5"	2	30	29	28
H-3783	Long	20 x 4 x 5"	3	34	33	32

## INDUSTRIAL SPRAY PAINT

INDOOR/OUTDOOR USE

Multipurpose enamel paint for pipes, machinery and lockers.

- Dries in 12 minutes. Ready to handle in one hour.
- Resists fading, chipping and peeling.
- Spray at any angle, even upside down.



SPECIFY COLOR: Black Yellow Red White Blue Orange Gray

MODEL NO.	DESCRIPTION	SIZE	QTY./CASE	PRICE PER CAN		
				6	12	24+
S-21952	Gloss Paint	12 oz.	6	\$9.25	\$8.75	\$8.25

SOLD IN CASE QUANTITIES

## HORIZONTAL STORAGE SHEDS

Store and protect sports equipment, landscaping tools and bikes.

- Weather-resistant plastic won't rust or rot.
- Hinged lid and double doors.
- Flooring included. Keeps out moisture and dirt.

**Stow-Away®** – Gas springs easily open lid and keep it in place.

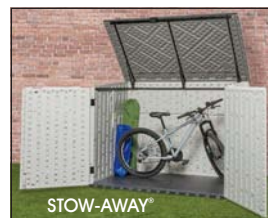

MODEL NO.	DESCRIPTION	CAPACITY (CU. FT.)	SIZE W x D x H	WT. (LBS.)	PRICE EACH	
					1	2+
H-9559	Horizontal	34	53 x 33 x 46"	68	\$355	\$345
H-8721	Stow-Away®	70	71 x 44 x 50"	125	495	475

SHIPS UNASSEMBLED VIA MOTOR FREIGHT



# WOOD PALLETS



## WOOD

This economical alternative is the workhorse of the industry.

- Tough, durable wood.
- Stackable, reusable.
- Heat-Treated pallets meet ISPM 15 export specifications.



- H-1218 meets standard GMA specifications.
- Drum Pallet H-1125 – Holds up to four 55-gallon drums.
- H-1618 fits Bulk Cargo Container, page 44.



## PRESSED WOOD

Lightweight, economical pallets.

- ISPM 15 exempt for export shipping.
- Stack 50 pallets in 8 feet!
- No nails to worry about.
- H-1219 and H-1816 save on truck space with smaller loads.
- H-1817 – 1,200 x 800 mm most common pallet size in European markets.



## RECYCLED WOOD

Sold in multiples of 10

MODEL NO.	WOOD TYPE	SIZE L x W	CAPACITY (LBS.)	FORK ACCESS	SHPG. WEIGHT	PRICE EACH (MIN. 10)		
						10	20	50+
H-2088	#1 Recycled	24 x 24"	1,000	2-way	15 lbs.	\$17	\$16	\$15
H-3444		30 x 30"	1,200	2-way	23 lbs.	19	18	17
H-1271		36 x 36"	1,500	2-way	30 lbs.	21	20	19
H-1272		42 x 42"	1,500	2-way	40 lbs.	24	23	22
H-1812		48 x 36"	1,500	4-way	35 lbs.	24	23	22
H-750		48 x 40"	2,500	4-way	40 lbs.	34	33	31
H-1813		48 x 42"	2,000	4-way	42 lbs.	34	33	31
H-2699		48 x 48"	3,000	2-way	50 lbs.	57	56	54
H-2089	Heat-Treated	48 x 40"	2,500	4-way	40 lbs.	37	36	34

SHIPS VIA MOTOR FREIGHT

## NEW WOOD

Sold in multiples of 5

MODEL NO.	WOOD TYPE	SIZE L x W	CAPACITY (LBS.)	FORK ACCESS	SHPG. WEIGHT	PRICE EACH (MIN. 5)		
						5	10	20+
H-3445	New Wood	36 x 36"	3,500	2-way	30 lbs.	\$36	\$35	\$34
H-1218		48 x 40"	2,500	4-way	42 lbs.	55	54	52
H-1125		48 x 48"	3,500	2-way	52 lbs.	60	59	57
H-1627		96 x 48"	7,000	4-way	104 lbs.	114	111	108
H-8944	Heat-Treated Export	36 x 36"	3,500	2-way	30 lbs.	37	36	35
H-2327		40 x 40"	2,500	2-way	38 lbs.	41	40	38
H-1814		42 x 42"	4,000	2-way	40 lbs.	51	50	48
H-1628		47 x 32"	5,000	2-way	32 lbs.	46	45	44
H-1260		48 x 40"	2,500	4-way	40 lbs.	59	58	56
H-2328		48 x 42"	3,000	4-way	42 lbs.	59	58	56
H-1629		48 x 48"	3,500	2-way	50 lbs.	64	63	61
H-1618		58 x 41"	2,000	4-way	60 lbs.	69	68	66
H-1815	72 x 48"	7,000	4-way	75 lbs.	92	90	87	
H-2329	96 x 48"	7,000	4-way	100 lbs.	120	117	114	

SHIPS VIA MOTOR FREIGHT

## PRESSED WOOD

MODEL NO.	DESCRIPTION	SIZE L x W	CAPACITY (LBS.)	FORK ACCESS	SHPG. WEIGHT	PRICE EACH (MIN. 5)		
						5	10	25+
H-1263	Euro*	31.5 x 23.6"	1,500	2-way	12 lbs.	\$22	\$21	\$20
H-1816	Regular Duty	24 x 40"	1,500	2-way	21 lbs.	19	18	17
H-1219		42 x 42"	1,500	4-way	36 lbs.	26	25	24
H-1032		48 x 40"	2,000	4-way	39 lbs.	28	27	26
H-1441		48 x 42"	2,000	4-way	41 lbs.	29	28	27
H-1817	Euro**	47.24 x 31.5"	2,000	4-way	26 lbs.	32	31	30
H-1262	Heavy Duty	48 x 40"	2,500	4-way	40 lbs.	30	29	28

\* 800 x 600 mm International Standard  
\*\* 1,200 x 800 mm International Standard

SHIPS VIA MOTOR FREIGHT

# PLASTIC PALLETS

## ECONOMY

Durable, thermoformed plastic. Reusable.

- Stack up to 60 pallets in 8 ft. • 4-way forklift access and 9-legged support.
- Recommended for international shipments where wood pallets require heat treatment or fumigation.
- H-1022 and H-1304 heavy-duty pallets are designed for heavier loads.

MODEL NO.	SIZE L x W	WEIGHT CAPACITY		SHPG. WEIGHT	PRICE EACH (MIN. 5)		
		FLOOR	FORK		SHIPS VIA MOTOR FREIGHT		
		5			10	20+	
H-990	48 x 40"	3,500 lbs.	1,200 lbs.	14 lbs.	\$48	\$47	\$46
H-1022	48 x 40"	6,500 lbs.	3,000 lbs.	21 lbs.	75	73	71
H-1304	48 x 42"	6,500 lbs.	2,500 lbs.	22 lbs.	84	82	80



## INDUSTRIAL

Strong, injection-molded plastic. Reusable.

- Recommended for international shipments where wood pallets require heat treatment or fumigation.
- Stack 40 pallets in 8 feet. • 4-way forklift access.
- Weather resistant up to 120°F.

H-7426 – USDA and FDA compliant.

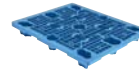

H-7426

MODEL NO.	SIZE L x W	WEIGHT CAPACITY		SHPG. WEIGHT	PRICE EACH (MIN. 5)		
		FLOOR	FORK		SHIPS VIA MOTOR FREIGHT		
		5			10	20+	
H-1023	48 x 40" Black	10,000 lbs.	2,700 lbs.	22 lbs.	\$54	\$54	\$54
H-7426	48 x 40" Blue				68	66	64

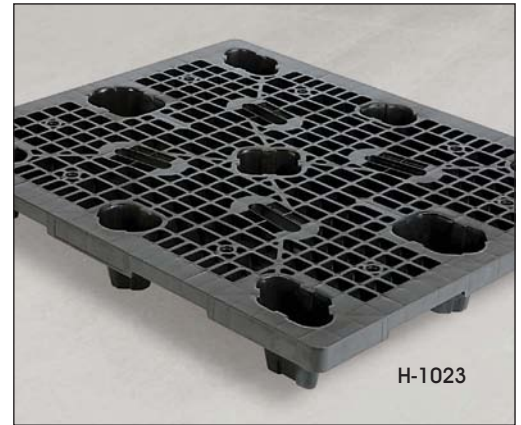

## HEAVY DUTY

Tough, durable structural foam pallet. Reusable.

- 4-way forklift access.
- Stack up to 38 pallets in 8 feet.
- Drain holes in deck and feet keep loads dry.

MODEL NO.	SIZE L x W	WEIGHT CAPACITY		SHPG. WEIGHT	PRICE EACH		
		FLOOR	FORK		SHIPS VIA MOTOR FREIGHT		
		1			5	10+	
H-6096	48 x 40"	30,000 lbs.	4,000 lbs.	34 lbs.	\$89	\$87	\$85
H-8172	48 x 48"			46 lbs.	135	130	125



## DRUM

Stop 55-gallon drums from shifting during transport.

- Four recessed rings hold drums securely. 4-way forklift access. Reusable.

H-1126 – Stackable, nestable thermoformed plastic.

H-1729 – 30,000 lb. capacity. Structural foam with deeper recessed rings for your heaviest loads.

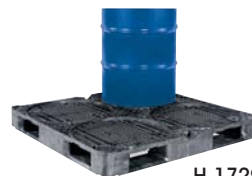

H-1729

MODEL NO.	SIZE L x W	WEIGHT CAPACITY		SHPG. WEIGHT	PRICE EACH		
		FLOOR	FORK		SHIPS VIA MOTOR FREIGHT		
		1			5	10+	
H-1126	48 x 48"	8,400 lbs.	2,800 lbs.	27 lbs.	\$115	\$110	\$105
H-1729		30,000 lbs.	4,000 lbs.	57 lbs.	245	240	235







## BLOCK PALLET

5,500 LB. CAPACITY

Wholesale clubs ship, rack and store their heaviest loads.

- Solid 5" wide blocks provide exceptional deck support. Stackable, reusable.
- 4-way forklift access. • Meets ISPM 15 export specifications.
- Wood Pallets complete line, see page 418.



HEAT-TREATED STAMP

### NEW WOOD

MODEL NO.	WOOD TYPE	SIZE L x W	WEIGHT CAPACITY	SHPG. WEIGHT	PRICE EACH (MIN. 5)		
					5	10	20+
H-4793	Heat-Treated	48 x 40"	5,500 lbs.	59 lbs.	\$99	\$96	\$93

SHIPS VIA MOTOR FREIGHT



## STACKABLE PALLETS

Cube out trailers without crushing product.

- 4-way forklift access. • ISPM 15 exempt for export shipping.
- Unique snap-together base distributes load evenly. Recycled plastic. Ships unassembled.

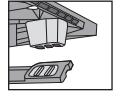

Snap-Together Base

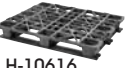

H-10616



H-10617

H-10617 – Closed deck provides extra support and reduces damage.

MODEL NO.	DESCRIPTION	SIZE L x W	WEIGHT CAPACITY		SHPG. WEIGHT	PRICE EACH (MIN. 5)		
			FLOOR	FORK		5	10	20+
H-10616	Open	48 x 40"	7,500 lbs.	3,000 lbs.	33 lbs.	\$59	\$57	\$56
H-10617	Closed	48 x 40"	10,000 lbs.	5,000 lbs.	36 lbs.	63	61	60

SHIPS VIA MOTOR FREIGHT



ALUMINUM

## HEAVY DUTY PALLETS

CORROSION RESISTANT

Strong pallets that survive the wear and tear of harsh conditions.

- Easy to clean with pressure washers, steam or scrubbing.
- ISPM 15 exempt for export shipping.
- All-welded construction lasts 4 times longer than wood or plastic.

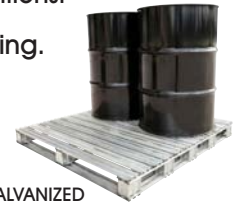

GALVANIZED

### 1 YEAR WARRANTY

MODEL NO.	DESCRIPTION	SIZE L x W	WEIGHT CAPACITY (LBS.)			SHPG. WEIGHT	PRICE EACH		
			FLOOR	FORK	RACK		1	3	5+
H-7124	Galvanized	48 x 48"	8,000	4,000	2,200	73 lbs.	\$285	\$275	\$265
H-4062	Aluminum	48 x 40"	30,000	5,000	5,000	48 lbs.	425	415	405
H-4063		48 x 48"					475	465	455

SHIPS VIA MOTOR FREIGHT

## PNEUMATIC PALLET POSITIONER

Back-saving positioner elevates and rotates pallets 360°. Use in repacking, unloading and assembly areas.

- Pneumatic airbag system automatically maintains specific working height.
- Fill airbag with shop air or a compressor – Does not need constant air source to operate.



USE WITH FORKLIFT

MODEL NO.	PLATFORM DIAMETER	CAPACITY (LBS.)	HEIGHT LOWERED	HEIGHT RAISED	WT. (LBS.)	PRICE EACH
H-1820	43 5/8"	4,500	9 1/2"	27 3/4"	377	\$3,350

SHIPS ASSEMBLED VIA MOTOR FREIGHT



# EXPORT PALLETS

ECONOMICAL

- Stack up to 60 pallets in 8 feet.
  - ISPM 15 exempt for export shipping.
  - Durable, injection-molded plastic won't rot or split.
  - 4-way forklift access and 9-legged support.
- H-6135 – For air freight and 42 x 42" bulk bags.

CALL FOR QUANTITY QUOTES



Sturdy, cost-effective pallet – Ideal for one-way shipping.

MODEL NO.	SIZE L x W	WEIGHT CAPACITY		SHPG. WEIGHT	PRICE EACH (MIN. 5)		
		FLOOR	FORK		5	10	25+
■H-1730	48 x 40"	3,000 lbs.	1,200 lbs.	14 lbs.	\$25	\$25	\$25
H-2681	24 x 32"	5,000 lbs.	2,000 lbs.	9 lbs.	26	25	24
■H-6135	43 x 43"			22 lbs.	41	40	39
■H-3017	45 x 45"			23 lbs.	42	41	40
■H-1611*	48 x 32"			21 lbs.	36	35	34
■H-1449	48 x 40"			22 lbs.	31	31	31
■H-1612	48 x 45"			24 lbs.	41	40	39

\*1,200 x 800 mm Euro

■ SHIPS VIA MOTOR FREIGHT

# CLOSED DECK EXPORT PALLET

Smooth, solid top won't scratch, gouge or indent cases of product.

- Closed deck adds strength and rigidity. Ideal for one-way shipping.
- Stack up to 48 pallets in 8 feet.
- ISPM 15 exempt for export shipping.
- 4-way forklift access and 9-legged support.

MODEL NO.	SIZE L x W	WEIGHT CAPACITY		SHPG. WEIGHT	PRICE EACH (MIN. 5)		
		FLOOR	FORK		5	10	20+
H-4061	48 x 40"	7,000 lbs.	2,250 lbs.	24 lbs.	\$37	\$36	\$35

SHIPS VIA MOTOR FREIGHT



# HEAVY DUTY EXPORT PALLETS New

Durable, weather-resistant pallet for cross-country shipments.

- Stack up to 48 pallets in 8 feet.
- ISPM 15 exempt for export shipping.
- Tough structural foam.
- 4-way forklift access.

H-10620 – Smooth closed deck adds support and reduces damage.

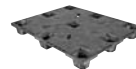

H-10620

MODEL NO.	DESCRIPTION	SIZE L x W	WEIGHT CAPACITY		SHPG. WEIGHT	PRICE EACH (MIN. 5)		
			FLOOR	FORK		5	10	20+
H-10619	Open	48 x 40"	6,500 lbs.	2,250 lbs.	22 lbs.	\$38	\$37	\$36
H-10620	Closed		8,500 lbs.	2,500 lbs.	24 lbs.	42	41	40

SHIPS VIA MOTOR FREIGHT

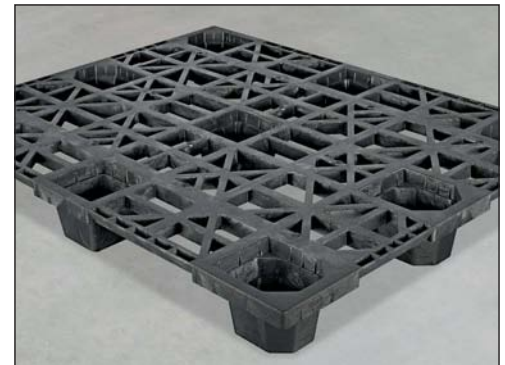

# SPRING-LOADED PALLET POSITIONER

Maintenance free. Recommended for repack areas and assembly plants.

- Provides proper working height to save your back.
- Add or remove springs to adjust weight capacity. Safety locks secure springs.
- Rotating turntable brings the work to you.
- Easy setup, no tools required.

MODEL NO.	PLATFORM DIAMETER	CAPACITY (LBS.)	HEIGHT LOWERED	HEIGHT RAISED	WT. (LBS.)	PRICE EACH
H-8935	43 <sup>5</sup> / <sub>8</sub> "	4,500	9 <sup>1</sup> / <sub>2</sub> "	27 <sup>3</sup> / <sub>4</sub> "	420	\$1,995

SHIPS VIA MOTOR FREIGHT



USE WITH FORKLIFT

# RACKABLE PALLETS

STRUCTURAL FOAM



Store products in racks with these reusable pallets. Durable, clean, sanitary.

- Eliminate loose nails, splinters.
- One-piece structural foam is easy to clean.

H-1212 – USDA and FDA compliant. Easily identify inventory.

H-8933 – FM approved to reduce the spread of flames.

Meets NFPA standards. FDA compliant.



\* SPECIFY COLOR: Blue, Red, Yellow or Green

MODEL NO.	SIZE L x W	WEIGHT CAPACITY (LBS.)			SHPG. WEIGHT	PRICE EACH		
		FLOOR	FORK	RACK		1	5	10+
H-1211	48 x 40" Black			2,000	50 lbs.	\$135	\$135	\$135
H-1212*	48 x 40"	30,000	5,000	2,200	50 lbs.	155	155	155
H-8933	48 x 40" FM Blue			2,200	62 lbs.	225	220	215
H-4059	48 x 48" Black	20,000	3,200	1,600	50 lbs.	150	145	140

SHIPS VIA MOTOR FREIGHT



# SOLID TOP RACKABLE PALLETS

Store bottled beverages or cases of beer and soda in racks.

- Durable, injection-molded plastic.
- 4-way forklift access.

H-8165 – USDA and FDA compliant. Smooth and sealed to prevent bacteria growth.

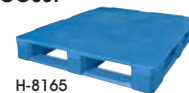

H-8165

- Solid, smooth top won't rip bags or cases of product.
- No crevices for dirt or grime. Easy wipe down.

MODEL NO.	SIZE L x W	WEIGHT CAPACITY (LBS.)			SHPG. WEIGHT	PRICE EACH		
		FLOOR	FORK	RACK		1	5	10+
H-5490	48 x 40" Black	14,000	4,000	1,600	42 lbs.	\$110	\$105	\$100
H-6136	48 x 40" Black	30,000	5,000	2,800	53 lbs.	160	155	150
H-8165	48 x 40" Blue	14,000	4,400	2,200	44 lbs.	155	150	145
H-7503	48 x 48" Black	11,000	5,000	2,700	61 lbs.	245	240	235

SHIPS VIA MOTOR FREIGHT

# RIGID BULK CONTAINERS

SHORTIES

Short, fixed-wall containers for automobile components, bearings and industrial parts.

- Provides outstanding support for heavy and bulky items.
- Easy to load and unload contents. Solid HDPE construction.
- Exceptional stacking strength – Up to 6 high.
- 4-way forklift access.



\* Meets AIAG Specifications

MODEL NO.	OUTSIDE DIMENSIONS L x W x H	WEIGHT CAPACITY	SHPG. WEIGHT	PRICE EACH		
				1	3	5+
H-8926	32 x 30 x 18"		51 lbs.	\$215	\$205	\$195
H-8927*	48 x 45 x 19"	2,000 lbs.	104 lbs.	340	330	320
H-9617*	48 x 45 x 24"		117 lbs.	395	385	375

SHIPS VIA MOTOR FREIGHT



# RIGID STEEL BULK CONTAINER

All-welded corrugated steel. Holds 2 tons of heavy parts.

- Heavy-duty 12-gauge construction. Made in the USA.
- 1/4" thick steel stacking feet. Stacks up to 4 high.
- 4-way forklift access.
- Easy-to-clean rounded corners.

- Recommended for machine shops, metal fabricators and scrap yards.

MODEL NO.	OUTSIDE DIM. L x W x H	WEIGHT CAPACITY	SHPG. WEIGHT	PRICE EACH		
				1	3	5+
H-8934	50 x 42 x 29"	4,000 lbs.	258 lbs.	\$895	\$880	\$865

SHIPS VIA MOTOR FREIGHT

## MOBILE PALLET STAND



More info, see [uline.com](http://uline.com)

MODEL NO.	PRICE EACH	
	1	3+
H-10612	\$760	\$740

# STEEL DUMPING HOPPERS



Standard  
2,000 lb.  
capacity

Made for really tough jobs. Safely transport and dump heavy loads.

- All-welded steel construction.
- Simply pull cable from the seat of your forklift to release hopper.
- Safety chain secures hopper to forklift.



Heavy Duty  
6,000 lb.  
capacity

## STANDARD

▲ Also available in Red

MODEL NO.	SUGGESTED USE	CUBIC YARD	CAP. (LBS.)	FORK POCKET CENTERS	OVERALL DIM. L x W x H	WT. (LBS.)	PRICE EACH	
							1	2+
H-2641	Wood, Corrugated	1/2	2,000	18" W	52 x 34 x 38"	385	\$1,320	\$1,295
H-2108▲		1		18" W	61 x 42 x 43"	445	1,515	1,485
H-2109*▲		2		28" W	69 x 57 x 52"	692	1,745	1,710

## INDUSTRIAL

H-6755	Steel Parts, Debris	1	4,000	18" W	61 x 42 x 43"	565	\$1,685	\$1,650
H-6756*		2		28" W	69 x 57 x 52"	700	1,980	1,945

## HEAVY DUTY

H-6757	Concrete, Metal	1/2	6,000	18" W	52 x 34 x 38"	418	\$1,420	\$1,395
H-2110		1		18" W	61 x 42 x 43"	579	1,845	1,810
H-2111*▲		2		28" W	69 x 57 x 52"	761	2,365	2,320
H-2642*		3		28" W	69 x 82 x 51"	991	3,270	3,205
H-6758*		4		28" W	80 x 73 x 65"	1,254	3,930	3,860
H-6759*		5		28" W	80 x 90 x 65"	1,436	4,590	4,520

SHIPS ASSEMBLED VIA MOTOR FREIGHT

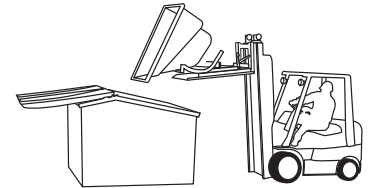

- Standard – 2,000 lb. capacity.
- Industrial – 4,000 lb. capacity.
- Heavy Duty – 6,000 lb. capacity.

• H-2108, H-2109 and H-2111 also available in Red.

\* Drop ships in 3 days from IN.

# QUICK RELEASE STEEL DUMPING HOPPERS

Hopper automatically releases when pushed against dumpster.

- Returns to locked, upright position when complete.
- Includes pull cable for secondary release.
- All-welded steel construction.

## STANDARD

SPECIFY COLOR: Blue or Red

MODEL NO.	SUGGESTED USE	CUBIC YARD	CAP. (LBS.)	FORK POCKET CENTERS	OVERALL DIM. L x W x H	WT. (LBS.)	PRICE EACH	
							1	2+
H-8928*	Wood, Corrugated	1	2,000	18" W	61 x 42 x 43"	459	\$1,690	\$1,655
H-8929*		2		28" W	69 x 57 x 52"	705	1,915	1,880

## INDUSTRIAL

COLOR: Blue

H-9700*	Steel Parts, Debris	1	4,000	18" W	61 x 42 x 43"	579	\$1,870	\$1,835
H-9701*		2		28" W	69 x 57 x 52"	714	2,175	2,135

## HEAVY DUTY

COLOR: Blue

H-9702*	Concrete, Metal	1	6,000	18" W	61 x 42 x 43"	593	\$2,045	\$2,005
H-9703*		2		28" W	69 x 57 x 52"	775	2,590	2,545

\* DROP SHIPS IN 3 DAYS FROM IN • Easy assembly required

SHIPS ASSEMBLED VIA MOTOR FREIGHT



Bumper plate triggers hopper to tilt and dump contents.

# HOPPER LIDS



Provide a clean appearance. Includes front lock bar.

SHIPS UNASSEMBLED VIA MOTOR FREIGHT

MODEL NO.	FITS (CUBIC YD.)	WT. (LBS.)	PRICE EACH	
			1	2+
H-3507	1	26	\$290	\$280
H-3508*	2	47	380	370

\* DROP SHIPS IN 3 DAYS FROM IN

# CASTERS



Provide easy mobility. Set of 4 steel casters: 2 swivel, 2 rigid.

MODEL NO.	CAP. (LBS.)	WHEEL DIAMETER	PRICE PER SET	
			1	2+
H-2112	4,800	6"	\$285	\$275



# COLLAPSIBLE WIRE CONTAINERS



H-1734

- Stackable, with or without casters.
- Folds down for easy storage.
- 4-way forklift access.
- H-1735, H-2682 and H-2092 – Lid included.

Store and quickly identify large, bulky items.

- Easy access with fold-down gate.
- Zinc-coated steel. Open mesh construction allows excellent ventilation.



COLLAPSIBLE

SHIPS VIA MOTOR FREIGHT

MODEL NO.	DESCRIPTION	OUTSIDE DIMENSIONS L x W x H	WEIGHT CAPACITY	SHPG. WEIGHT	PRICE EACH		
					1	3	6+
H-1613	No Casters	32 x 20 x 21"	1,000 lbs.	43 lbs.	\$180	\$175	\$170
H-1731		40 x 32 x 34½"	4,000 lbs.	103 lbs.	265	260	255
H-2090		48 x 40 x 30½"		140 lbs.	325	320	315
H-1614		48 x 40 x 36½"		155 lbs.	345	340	335
H-1732		48 x 40 x 42½"		167 lbs.	360	355	350
H-1615	With Casters	32 x 20 x 22"	1,000 lbs.	58 lbs.	300	295	290
H-1733		40 x 32 x 35½"	2,800 lbs.	120 lbs.	455	445	435
H-2091		48 x 40 x 31½"		157 lbs.	485	475	465
H-1616		48 x 40 x 37½"		172 lbs.	525	515	505
H-1734		48 x 40 x 43½"		184 lbs.	545	535	520
H-1735	No Casters w/ Lid	48 x 40 x 36½"	4,000 lbs.	184 lbs.	485	475	465
H-2682		48 x 40 x 42½"		197 lbs.	500	490	480
H-2092	Casters w/ Lid	48 x 40 x 37½"	2,800 lbs.	192 lbs.	630	615	605

## ULINE CORROSION RESISTANT PALLET TRUCKS



STOCKED IN 13 LOCATIONS ACROSS NORTH AMERICA

GALVANIZED

Heavy-duty trucks withstand harsh conditions.

- 3-position hand control – Raise, lower, neutral.
- 210° steering arc.
- 3" lowered and 7.5" raised height.
- 7" nylon wheels.

**Galvanized** – For outdoor lumberyards and fishing docks.

**Stainless Steel** – For cleanrooms, food plants and freezers.



STAINLESS STEEL

SHIPS ASSEMBLED VIA MOTOR FREIGHT

MODEL NO.	DESCRIPTION	FORK SIZE L x W	LOAD CAPACITY	WT. (LBS.)	PRICE EACH	
					1	3+
H-2186	Galvanized	48 x 27"	5,500 lbs.	157	\$690	\$655
H-2185	Stainless Steel	48 x 27"		173	2,270	2,210

## ULINE STEEL WHEEL PALLET TRUCK

Wheels that last a lifetime. Tackles extreme surfaces.

- Recommended for foundries, machine shops and junkyards.
- 3-position hand control – Raise, lower, neutral.
- 3" lowered and 7.5" raised height.
- 7" steel wheels. 210° steering arc.



SHIPS ASSEMBLED VIA MOTOR FREIGHT

MODEL NO.	FORK SIZE L x W	LOAD CAPACITY	WT. (LBS.)	PRICE EACH	
				1	3+
H-7574	48 x 27"	5,500 lbs.	168	\$495	\$475

## PALLET TRUCK STOP

Unique design securely holds wheels in place.

- Anchor pallet trucks during transit on trucks.
- Nonslip synthetic rubber works on all surfaces.



MODEL NO.	OVERALL W x L	WHEEL OPENING	WT. (LBS.)	PRICE EACH	
				1	3+
H-2456	12 x 14"	9 x 6"	4	\$45	\$42

# COLLAPSIBLE BULK CONTAINERS



32" LONG



48" LONG

**IN STOCK - SHIPS TODAY  
FROM 13 LOCATIONS**



62" LONG

Shipping protection for heavy-duty machinery, large parts and bulky items.

- Long-term reusable, returnable. Save on return freight and storage.
- Corners interlock for quick setup and added stability.
- Two access doors with spring-loaded latches.
- 4-way forklift access.

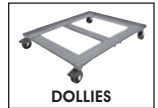

## CONTAINERS

Black Blue Green

MODEL NO.	OUTSIDE DIMENSIONS L x W x H	WEIGHT CAPACITY	SHPG. WEIGHT	PRICE EACH		
				1	4	8+
H-4051	32 x 30 x 34"	1,500 lbs.	81 lbs.	\$285	\$280	\$270
H-4052▲	48 x 40 x 34"		137 lbs.	395	385	375
H-7830	48 x 45 x 25"	1,500 lbs.	108 lbs.	375	365	355
H-7831▲	48 x 45 x 34"		132 lbs.	395	385	375
H-4053*	48 x 45 x 42"		161 lbs.	460	450	440
H-1737*	48 x 45 x 50"		202 lbs.	605	590	575
H-1738	62 x 48 x 34"	1,500 lbs.	214 lbs.	805	785	765
H-9661	70 x 48 x 34"		220 lbs.	945	920	895
H-7988	78 x 48 x 34"		230 lbs.	995	970	945
H-8919	48 x 40 x 50"	1,750 lbs.	204 lbs.	605	590	575
H-2093*	32 x 30 x 25"	2,000 lbs.	68 lbs.	270	265	260
H-1213*	32 x 30 x 34"		84 lbs.	310	305	295
H-1269	48 x 40 x 34"	2,000 lbs.	154 lbs.	455	445	435
H-1736*	48 x 40 x 39"		156 lbs.	460	450	440

## LIDS

MODEL NO.	PRICE EACH
H-4101	\$65
H-4106	75
H-4107	80
H-4108	355
H-9662	410
H-7989	435
H-4106	75
H-4101	65
H-4110	75
H-4109	75
H-4106	75

## DOLLIES

MODEL NO.	PRICE EACH
H-4054	\$240
H-4055	270
H-4056	280
N/A	—
H-4055	270
H-4054	240
H-4055	270

\* SPECIFY COLOR: Black or FDA Compliant Blue

▲ SPECIFY COLOR: Black, FDA Compliant Blue or Green

SHIPS VIA MOTOR FREIGHT

### LIDS

Raised edges keep containers secure when stacked.



### DOLLIES

Heavy-duty, welded steel construction. 5" phenolic casters: 4 lockable swivel.



### STACKABLE

Collapsible and stackable. Stacks up to 4 high.



# ULINE INDUSTRIAL PALLET TRUCKS



Let your personal pallet truck stand out.

- Reinforced frame and bulkhead.
- 3-position hand control – Raise, lower, neutral.
- 3" lowered and 7.5" raised height.
- 7" polyurethane wheels.

Low Profile – 2" lowered and 6.5" raised height.



SHIPS ASSEMBLED VIA MOTOR FREIGHT

MODEL NO.	DESCRIPTION	FORK SIZE L x W	COLOR	LOAD CAPACITY	WT. (LBS.)	PRICE EACH	
						1	3+
H-2708	Standard	48 x 27"	Lime Blue	5,500 lbs.	165	\$405 each	
H-7504							
H-5387	Standard	48 x 27"	Red	5,500 lbs.	165	\$405 each	
H-2900						Yellow	
H-3045							Pink
H-9612	Low Profile	48 x 27"	Blue	4,400 lbs.	188	\$600	\$580
H-8921	Long	72 x 27"	Blue	5,500 lbs.	258	970	925

# ULINE DELUXE PALLET TRUCK



Uline's version of the "Cadillac Escalade SUV."

Move big, heavy loads.

- Heavy-gauge steel construction. Reinforced frame and bulkhead.
- 3-position hand control – Raise, lower, neutral.
- 3" lowered and 7.5" raised height.
- 7" polyurethane wheels. Two front wheels on each side. 180° steering arc.

SHIPS ASSEMBLED VIA MOTOR FREIGHT

MODEL NO.	DESCRIPTION	FORK SIZE L x W	LOAD CAPACITY	WT. (LBS.)	PRICE EACH	
					1	3+
H-2721	Deluxe	48 x 27"	7,700 lbs.	201	\$615	\$595

# BATTERY POWERED PALLET TRUCK

BIG JOE®



Dock worker's best friend. Powered navigation for small warehouses, limited stock areas and retail floors.

- Quick-change battery reduces downtime. Lithium ion lasts 4 times longer than traditional batteries.
- Push-button lift control and forward/reverse thumb wheels on handle.
- 3 hours service per charge. 2½ hour charge time.



REPLACEABLE LITHIUM ION BATTERY

- 3" lowered and 7½" raised height.
- Polyurethane wheels.

\*Includes one lithium ion battery and charger

SHIPS ASSEMBLED VIA MOTOR FREIGHT

MODEL NO.	FORK SIZE L x W	LOAD CAPACITY	DRIVE MOTOR	WHEEL DIAMETER	WT. (LBS.)	PRICE EACH
H-7505*	45 x 27"	2,600 lbs.	.65 kw DC	8" / 2¼"	288	\$2,935
H-7506	Replacement Lithium Ion Battery				18	815



# ULINE PALLET TRUCKS

Dependable pallet trucks at an affordable price.

- 3-position hand control – Raise, lower, neutral.
- 3" lowered and 7.5" raised height.
- 7" polyurethane wheels. 210° steering arc.

**Hand Brake** – Stops loads safely without straining your back. Plus, better control on downslopes.

**Narrow** – Fits into narrow pallets.

**Short** – Handles pallets up to 42" with ease.

**Long** – Reaches under longer specialty pallets.

**Low Profile** – Slides into openings only 2" high. 2" lowered and 5.6" raised height. 6" wheels.



SHIPS ASSEMBLED VIA MOTOR FREIGHT

MODEL NO.	DESCRIPTION	FORK SIZE L x W	LOAD CAPACITY	WT. (LBS.)	PRICE EACH	
					1	3+
H-1043	Standard	48 x 27"	5,500 lbs.	153	\$395 each	
H-4121	Hand Brake	48 x 27"		181	\$570	\$550
H-1193	Narrow	48 x 21"		137	425	405
H-1484	Short	36 x 27"		136	435	415
H-4803	Short	42 x 27"		145	425	405
H-1366	Short/Narrow	36 x 21"	130	425	405	
H-4122	Short/Extra Narrow	36 x 16"	4,400 lbs.	127	645	615

SHIPS ASSEMBLED VIA MOTOR FREIGHT

MODEL NO.	DESCRIPTION	FORK SIZE L x W	LOAD CAPACITY	WT. (LBS.)	PRICE EACH	
					1	3+
H-4804	Long	60 x 27"	5,500 lbs.	238	\$955	\$915
H-1779	Long	72 x 27"	3,300 lbs.	205	685	655
H-2640	Long/Narrow	72 x 21"	3,300 lbs.	200	705	675
H-4123	Extra Long	96 x 27"	5,500 lbs.	332	1,255	1,205
H-1365	Low Profile	48 x 27"		182	515	495
H-1780	Low Profile/Narrow	48 x 21"	3,300 lbs.	173	505	485
H-1781	Low Profile/4 Way	48 x 33"		212	735	705

# ULINE QUICK-LIFT PALLET TRUCKS

Newly designed pump lifts twice as fast.

- Fastest truck on the market. Move loads up to 330 lbs. with only two pumps.
- 3-position hand control – Raise, lower, neutral.
- 3" lowered and 7.5" raised height.
- 7" polyurethane wheels. 205° steering arc.

**Narrow** – Fits into narrow pallets.

SHIPS ASSEMBLED VIA MOTOR FREIGHT

MODEL NO.	DESCRIPTION	FORK SIZE L x W	LOAD CAPACITY	WT. (LBS.)	PRICE EACH	
					1	3+
H-3763	Standard	48 x 27"	4,400 lbs.	165	\$475	\$455
H-3762	Narrow	48 x 21"				



Slip-resistant ergonomic handle provides terrific comfort.

## SPECIALTY STYLES



# ELECTRIC PALLET TRUCKS

BIG JOE®

Effortlessly move heavier loads with these quiet, self-propelled trucks. Load and unload delivery and transfer trucks.

- Push-button lift controls and forward/reverse thumb wheels on an ergonomic handle. Reverse safety switch keeps operator safe.
- Maintenance-free batteries with charger. • Polyurethane wheels. • 180° steering arc.



H-4709

**H-4709** – 4½ hours service per charge. Compact design moves easily in narrow warehouse and retail aisles. 3 to 7½" lift range.

**H-4710** – 6 hours service per charge. Deluxe workhorse for continuous dock work and large warehouses. 3¼ to 8" lift range.

MODEL NO.	FORK SIZE L x W	LOAD CAPACITY	DRIVE MOTOR	WHEEL DIAMETER	WT. (LBS.)	PRICE EACH
H-4709	45 x 27"	3,000 lbs.	.65 kw DC	8" / 2¾"	489	\$4,050
H-4710		4,500 lbs.	.90 kw AC	9" / 3"	1,136	5,995

SHIPS ASSEMBLED VIA MOTOR FREIGHT

# STRADDLE STACKERS

SEMI-ELECTRIC

Go where forklifts can't. Use in small warehouses and loading docks.

- Manually push stacker into position. Use motor to raise and lower forks.
- 24" load center accommodates pallets up to 48". Legs adjust from 36½ to 48½".
- 2 hours service per charge. Rechargeable battery with built-in charger.
- 7" polyurethane rear swivel casters. 5" polyurethane front rigid casters.
- 180° steering arc. • 58" turning radius.



Fully Powered Stackers, see uline.com

H-5439

MODEL NO.	FORK SIZE L x W	LOAD CAPACITY	HEIGHT LOWERED	HEIGHT RAISED	WHEEL DIAMETER	WT. (LBS.)	PRICE EACH
H-5439	42 x 9-28"	2,200 lbs.	2⅞"	63"	7" / 5"	992	\$3,820
H-5440				137"		1,125	4,355

SHIPS ASSEMBLED VIA MOTOR FREIGHT

# SCISSOR LIFT TRUCKS

Manually raise open-bottom pallets to proper working height.

- Support legs deploy automatically to ensure operator safety.
- Automatically slows lowering speed to prevent damage with heavy loads.



Use with open-bottom pallet H-990



## STANDARD

Tight, 210° steering arc for easy maneuvering.

- 2,200 lb. capacity.

MODEL NO.	DESCRIPTION	FORK SIZE L x W	LOAD CAPACITY	HEIGHT LOWERED	HEIGHT RAISED	WHEEL DIAMETER	WT. (LBS.)	PRICE EACH
H-1785	Standard	45 x 27"	2,200 lbs.	3½"	31½"	7" / 3"	254	\$940
H-2507*		45 x 21"						
H-5441	Heavy Duty	46 x 27"	3,000 lbs.	3½"	31½"	7" / 3"	292	1,150
H-5442*		46 x 21"						

\* Fits into narrow pallets

SHIPS ASSEMBLED VIA MOTOR FREIGHT

## HEAVY DUTY

Durable single-piston design. 180° steering arc.

- 3,000 lb. capacity.

# ULINE LIFT TABLES

MOBILE



Double Scissor

Giant back savers lift heavy loads in the office, factory or warehouse.

- Foot pump hydraulically raises platform.
- Overload valve protects pump and operator.
- Polyurethane casters: 2 swivel with brake, 2 rigid.
- **Double Scissor** tables lift higher for easier shelf stocking.



Standard

## STANDARD

EASY ASSEMBLY. SHIPS VIA MOTOR FREIGHT.

MODEL NO.	PLATFORM L x W	CAPACITY (LBS.)	HEIGHT LOWERED	HEIGHT RAISED	WHEEL DIAMETER	WT. (LBS.)	PRICE EACH
H-1485	27 x 18"	330	8¾"	29"	4"	101	\$415
H-1486	32 x 20"	660	11"	35"	5"	165	545
H-1487		1,100				187	630
H-1783	40 x 20"	1,760	16½"	39½"	6"	254	835
H-10622		2,200	15"			275	920
H-6754	63 x 31½"	1,100	12½"	35"	5"	300	1,095

## DOUBLE SCISSOR

H-1784	36 x 20"	770	13¾"	51"	5"	223	\$770
H-8152	48 x 24"	1,760	18¾"	59"	6"	379	1,175

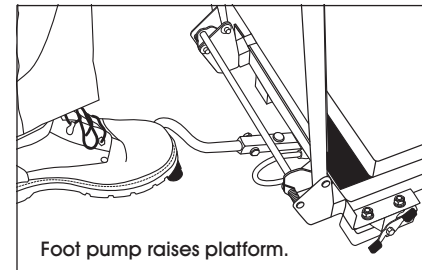

Foot pump raises platform.

Full line of Lift Tables, see [uline.com](http://uline.com)

# ULINE ELECTRIC LIFT TABLES New

Prevent back strain. Powerful motor lifts heavy loads to a comfortable working height.

- Lift and lower to desired height with simple push-button hand controls.
- Durable steel platform with heavy-duty pump. 115V electric motor. 8' power cord.
- Full perimeter safety guard keeps operator safe. Automatically stops table descent.



Electric

MODEL NO.	PLATFORM L x W	CAPACITY (LBS.)	HEIGHT LOWERED	HEIGHT RAISED	MOTOR HP	WT. (LBS.)	PRICE EACH
H-10646	48 x 36"	3,300	8"	39"	1½	704	\$2,700
H-10647	72 x 48"	5,500	9¾"	47"	3	1,540	3,500

SHIPS ASSEMBLED VIA MOTOR FREIGHT

# ULINE HEAVY DUTY PALLET TRUCK

Uline's version of the "Ford F-150." High-capacity pump lifts up to 5½ tons.

- For hauling iron castings, steel coils and transformers. Reinforced heavy-gauge steel construction.
- 3-position hand control – Raise, lower, neutral.
- 3" lowered and 7.5" raised height.
- Tough 7" nylon wheels. Two front wheels on each side. 180° steering arc.



Quick lift. Move up to 1,300 lbs. with only two pumps!

MODEL NO.	DESCRIPTION	FORK SIZE L x W	LOAD CAPACITY	WT. (LBS.)	PRICE EACH	
					1	3+
H-5484	Heavy Duty	48 x 27"	11,000 lbs.	253	\$1,250	\$1,195

SHIPS ASSEMBLED VIA MOTOR FREIGHT



# RUBBERMAID® TILT TRUCKS



Strong and dependable. The choice for warehouse and manufacturing facilities.

- Holds up to 5 times more than a 55-gallon can.
- Leakproof polyethylene body supported by tubular steel frame.
- Easy-to-clean interior. Won't dent or corrode.
- Made of FDA compliant resins.
- Balanced design allows for easy dumping by one person.
- 2 large rubber wheels, 2 swivel – Inset to protect walls.
- Standard, Heavy Duty and Fork Lifiable trucks include steel side rails for extra support.
- H-1951 and H-3099 – Forklift channels allow easy transportation throughout facility.
- Blue Recycling Tilt Truck, see page 405.

\* SPECIFY COLOR: Red or Black

LIDS – Black only

MODEL NO.	DESCRIPTION	SUGGESTED USE	CUBIC YARD	CAP. (LBS.)	WHEEL SIZE	OVERALL DIM. L x W x H	WT. (LBS.)	PRICE EACH		MODEL NO.	WT. (LBS.)	PRICE EACH	
								1	2+			1	2+
H-1108	Utility	Office Trash, Paper, Breakroom	1/2	450	10"	57 x 28 x 39"	63	\$620	\$595	H-1108L	22	\$180	\$170
H-1109			1	850	12"	73 x 34 x 44"	105	845	815	H-1109L	24	240	225
H-2639	Standard	Wood, Strapping, Heavy Corrugated	1/2	850	10"	61 x 28 x 39"	77	965	935	H-1108L	22	180	170
H-1378*			1	1,250	12"	73 x 34 x 44"	115	1,155	1,120	H-1109L	24	240	225
H-1379			1½	1,200	12"	81 x 43 x 50"	193	2,130	2,080	H-1379L	33	495	465
H-3098	Heavy Duty	Concrete, Metal Parts, Steel Debris	1/2	1,400	10"	61 x 28 x 39"	83	1,140	1,105	H-1108L	22	180	170
H-1380			1	2,100	12"	73 x 34 x 44"	112	1,290	1,250	H-1109L	24	240	225
H-1951	Fork Lifiable	Transport Bulky Loads	1	1,250	12"	73 x 34 x 44"	110	1,325	1,285	H-1109L	24	240	225
H-3099			1½	1,200	12"	81 x 43 x 50"	208	2,445	2,395	H-1379L	33	495	465

SHIPS ASSEMBLED VIA MOTOR FREIGHT



## POLY BULK TRUCK

Dependable workhorse for commercial laundries, hotels and hospitals.

- Tough polyethylene won't dent or corrode. Rust resistant, powder-coated steel base.
- Low-cut front opening for complete accessibility.
- 6" polyurethane casters: 2 swivel, 2 rigid.

SPECIFY COLOR: Black, Blue or Red

MODEL NO.	OVERALL DIM. L x W x H	CU. FT. CAP.	BUSHEL CAP.	CAP. (LBS.)	WT. (LBS.)	PRICE EACH	
						1	2+
H-5201	48 x 29 x 68"	48	38	1,000	135	\$920	\$880

DROP SHIPS IN 3 DAYS FROM WI

## JOBSITE BACKPACK

Take your tools to the field, roof or underground.

- Heavy-duty ballistic nylon with molded base.
- Front hardshell pocket.
- 48 pockets. Padded straps and handles.



MODEL NO.	DIMENSIONS W x D x H	WT. (LBS.)	PRICE EACH	
			1	3+
H-10524	15 x 11 x 19"	7	\$165	\$155

SHIPS VIA UPS

# ULINE TILT TRUCKS



Uline quality at an affordable price.

- Rugged polyethylene body won't rust, dent, chip or peel. **Standard** – Includes steel frame for extra support.
- Seamless plastic is easy to clean inside and out. **Heavy Duty** – Highest capacity for heaviest debris.
- 2 large rubber wheels, 2 swivel casters. **Hinged Lids** – Available in Black.

SPECIFY COLOR: Gray or Red

MODEL NO.	DESCRIPTION	SUGGESTED USE	CUBIC YARD	CAP. (LBS.)	WHEEL SIZE	OVERALL DIM. L x W x H	WT. (LBS.)	PRICE EACH		LIDS		PRICE EACH	
								1	2+	MODEL NO.	WT. (LBS.)	1	2+
H-6713	Utility	Office Trash	1/2	450	10"	57 x 28 x 39"	63	\$490	\$470	H-1108L	22	\$180	\$170
H-4184			1	850	12"	73 x 34 x 45"	102	640	610	H-1109L	24	240	225
H-4185	Standard	Wood, Strapping, Heavy Corrugated	1/2	850	10"	60 x 29 x 38"	79	695	665	H-1108L	22	180	170
H-4186			1	1,250	12"	73 x 34 x 45"	112	835	805	H-1109L	24	240	225
H-6714	Heavy Duty	Concrete, Metal Parts, Steel Debris	1/2	1,400	10"	61 x 28 x 39"	83	865	835	H-1108L	22	180	170
H-6715			1	2,100	12"	73 x 34 x 44"	112	985	955	H-1109L	24	240	225

SHIPS ASSEMBLED VIA MOTOR FREIGHT

## POLYETHYLENE DUMPING HOPPERS

Easy to safely empty – Just pull the handle. Forkliftable for elevated dumping.

- Mobile. Lighter weight for easier handling.
- Won't rust or dent. Leakproof, handles wet or dry materials.
- Pull handle releases safety latch for easy dumping.
- 6" polyolefin casters: 2 swivel, 2 rigid.

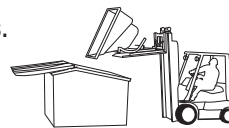

RUBBERMAID®

MODEL NO.	DESCRIPTION	SUGGESTED USE	CUBIC YARD	CAP. (LBS.)	FORK POCKET WIDTH	OVERALL DIM. L x W x H	WT. (LBS.)	PRICE EACH	
								1	2+
H-4187	Standard	Wood, Corrugated	1/2	750	22"	55 x 27 x 48"	212	\$2,470	\$2,345
H-4188			1	1,000	25"	72 x 32 x 53"	247	2,800	2,670

SHIPS ASSEMBLED VIA MOTOR FREIGHT



## PLATFORM TRUCKS

Transport loads through factories, loading docks and worksites. Durable and long lasting.

- Removable, contoured handle for a better grip.
- Steel reinforced structural foam deck resists corrosion and dents.
- 8" non-marking casters: 2 swivel, 2 rigid.

Platform Trucks, see pages 442-445.

MODEL NO.	DECK SIZE W x L	LOAD CAPACITY	WHEEL TYPE	WT. (LBS.)	RUBBERMAID® PRICE EACH	
					1	2+
H-5035	24 x 48"	2,000 lbs.	Rubber	70	\$680	\$650
H-5036	30 x 60"			88	825	795

SHIPS UNASSEMBLED VIA MOTOR FREIGHT

# ULINE POLY BOX TRUCKS



Transport wet laundry, bulk materials and trash in these sturdy, high-capacity trucks.

- Tough, seamless polyethylene is easy to clean.
- 4" polyurethane swivel casters offer easy mobility.
- Galvanized steel base.

For accessories, see [uline.com](http://uline.com)



SPECIFY COLOR: Blue, Gray, Red, Black, White, Green or Yellow

MODEL NO.	OVERALL DIM. L x W x H	CU. FT. CAP.	BUSHEL CAP.	CAP. (LBS.)	WT. (LBS.)	PRICE EACH	
						1	3+
H-2106	34 x 24 x 26"	7½	6		28	\$240	\$230
H-2107	39 x 27 x 29"	10	8	800	34	265	255
H-1954	40 x 30 x 33"	15	12		44	320	310

SHIPS ASSEMBLED VIA MOTOR FREIGHT

SPECIFY COLOR: Blue, Gray, Red, Black, White, Green or Yellow

MODEL NO.	OVERALL DIM. L x W x H	CU. FT. CAP.	BUSHEL CAP.	CAP. (LBS.)	WT. (LBS.)	PRICE EACH	
						1	3+
H-1955	45 x 33 x 36"	20	16		56	\$370	\$355
H-2649	47 x 35 x 36"	22	18	800	60	415	395
H-1956	52 x 37 x 36"	25	20		72	435	420

SHIPS ASSEMBLED VIA MOTOR FREIGHT



## RUBBERMAID® CUBE TRUCKS

Collect and transport leaky garbage and soaked towels from cafeterias, gymnasiums and theme parks.

- Turns on a dime. Diamond caster pattern allows for tight turns.
- Leakproof polyethylene.
- 5" polyolefin casters: 2 swivel, 2 rigid.

FDA COMPLIANT

Optional Lids, see [uline.com](http://uline.com)

MODEL NO.	OVERALL DIM. L x W x H	CU. FT. CAP.	BUSHEL CAP.	CAP. (LBS.)	WT. (LBS.)	PRICE EACH	
						1	3+
H-8194	44 x 31 x 37"	16	12	500	51	\$500	\$490
H-8195	48 x 34 x 37"	20	16	600	60	600	590

SHIPS ASSEMBLED VIA MOTOR FREIGHT



## HEAVY-DUTY POLY BOX TRUCK

Easily haul heavy packages and bulky items. Recommended for mail rooms, commercial laundries and recycling operations.

- Holds 50% more weight than standard poly box trucks.
- Removable 22 x 10" vinyl closures for easy access.
- High-density polyethylene won't crack, dent or corrode.
- 5" polyurethane casters: 2 swivel, 2 rigid.



Poly Tub Cart, see [uline.com](http://uline.com)

MODEL NO.	OVERALL DIM. L x W x H	CU. FT. CAP.	BUSHEL CAP.	CAP. (LBS.)	WT. (LBS.)	PRICE EACH	
						1	2+
H-3840	48 x 32 x 38"	23	18½	1,200	72	\$650	\$630

SHIPS ASSEMBLED VIA MOTOR FREIGHT



# BASKET TRUCKS



VINYL

HEAVY DUTY  
H-2099



CANVAS

Move wet or dry bulk loads such as packages, laundry and textiles.

- Vinyl – Tough, reinforced. Resists tears, punctures and abrasions.
- Canvas – Recommended for health clubs, hotels and locker rooms.
- Heavy Duty – Jumbo 24-bushel capacity. 4" polyurethane casters.
- Large document pocket, 6<sup>3</sup>/<sub>4</sub> x 6<sup>1</sup>/<sub>4</sub>".
- 3" polyurethane swivel casters for easy maneuvering.
- Spring Lifts and Lids, see [uline.com](http://uline.com)

MADE IN THE USA

## VINYL BASKET TRUCKS SPECIFY COLOR: Yellow, Red, Blue, Green or Black

MODEL NO.	OVERALL DIMENSIONS L x W x H	BUSHEL CAPACITY	WT. (LBS.)	PRICE EACH	
				1	3+
H-1806	30 x 20 x 27"	6	25	\$180	\$175
H-2446	36 x 24 x 32"	10	34	220	210
H-1373	36 x 26 x 34 <sup>1</sup> / <sub>2</sub> "	12	36	245	235
H-1807	40 x 28 x 37"	16	39	300	290
H-2647	42 x 30 x 37"	18	41	325	310
H-1580	48 x 32 x 37"	20	42	340	325
H-2099*	54 x 34 x 37 <sup>1</sup> / <sub>2</sub> "	24	54	450	435

\*Also available in Gray

SHIPS ASSEMBLED VIA MOTOR FREIGHT

## CANVAS BASKET TRUCKS

MODEL NO.	OVERALL DIMENSIONS L x W x H	BUSHEL CAPACITY	WT. (LBS.)	PRICE EACH	
				1	3+
H-1808	30 x 20 x 27"	6	26	\$190	\$185
H-2447	36 x 24 x 32"	10	36	230	220
H-1581	36 x 26 x 34 <sup>1</sup> / <sub>2</sub> "	12	38	255	245
H-1809	40 x 28 x 37"	16	41	310	300
H-2648	42 x 30 x 37"	18	43	335	320
H-1582	48 x 32 x 37"	20	44	355	340
H-2100	54 x 34 x 37 <sup>1</sup> / <sub>2</sub> "	24	56	465	450

SHIPS ASSEMBLED VIA MOTOR FREIGHT

# STRUCTURAL FOAM TILT TRUCKS

RUBBERMAID®



Optional Hinged Lid, see [uline.com](http://uline.com)

Maneuver garbage and waste from lunchroom to dumpster.

- Comfortable, ergonomic handle. Turns on a dime.
- Non-marking rubber casters protect floors. 12" wheels.

H-1952 and H-1953 – Fits easily through doorways and elevators.

MODEL NO.	DESCRIPTION	SUGGESTED USE	CUBIC YARD	CAP. (LBS.)	OVERALL DIM. L x W x H	WT. (LBS.)	PRICE EACH	
							1	2+
H-1952	Utility	Bulk Paper, Restroom Trash, Used Bubble	3/4	600	65 x 30 x 38"	92	\$790	\$770
H-1953 H-8169	Standard	General Refuse and Light Material Handling	3/4 1	1,000 1,250	65 x 30 x 38" 71 x 34 x 43"	101 139	925 1,180	900 1,150

SHIPS ASSEMBLED VIA MOTOR FREIGHT

# ULINE UTILITY CARTS



Built tough in the USA!

- Ready for duty in offices, stockrooms and warehouses.
- Lightweight, quiet and easy to maneuver in tight spots.
- Sturdy structural foam. Rounded edges prevent wall damage.
- 2 $\frac{5}{8}$ " deep trays are 19" apart.
- Non-marking 5" quiet rubber casters: 2 swivel, 2 rigid.
- Replacement casters and accessories, see [uline.com](http://uline.com)
- Easy assembly. Ships via UPS.



SPECIFY COLOR: Black Gray Red Blue Green

MODEL NO.	DIMENSIONS L x W x H	LOAD CAPACITY	SHELF QTY.	WT. (LBS.)	PRICE EACH	
					1	3+
H-2503	40 x 18 x 33"	500 lbs.	2	31	\$140	\$130
H-2504	45 x 25 x 33"				<b>\$145 each</b>	

## WITH PNEUMATIC WHEELS



Easy rolling wheels for smooth rides over rough surfaces.

- Sturdy structural foam.
- 8" pneumatic casters.
- 2 $\frac{5}{8}$ " deep trays are 19" apart.
- Easy assembly. Ships via UPS.



SPECIFY COLOR: Black Gray

MODEL NO.	DIMENSIONS L x W x H	LOAD CAPACITY	SHELF QTY.	WT. (LBS.)	PRICE EACH	
					1	3+
H-2505	45 x 25 x 37"	500 lbs.	2	67	\$310	\$295

## FLAT SHELF WITH PNEUMATICS



Roll oversized items smoothly over uneven surfaces.

- Top shelf doubles as a work surface.
- Sturdy structural foam.
- 8" pneumatic casters.
- Easy assembly. Ships via UPS.

MODEL NO.	DIMENSIONS L x W x H	LOAD CAPACITY	SHELF QTY.	WT. (LBS.)	PRICE EACH	
					1	3+
H-4146	44 x 25 x 37"	500 lbs.	2	70	\$320	\$305

## FLAT SHELF CARTS



Load and unload oversized items easily.

- Top shelf doubles as a work surface.
- Non-marking 5" casters: 2 swivel, 2 rigid.
- Easy assembly. Ships via UPS.



SPECIFY COLOR: Black Red

MODEL NO.	DIMENSIONS L x W x H	LOAD CAPACITY	SHELF QTY.	WT. (LBS.)	PRICE EACH	
					1	3+
H-3324	38 x 17 x 33"	500 lbs.	2	35	\$150	\$140
H-3325	44 x 25 x 33"				170	160

## STEEL PUSH CARTS



Substantial capacity and enclosed shelves for worry-free transport.

- Durable steel construction.
- 3" deep trays are 20" apart.
- 5" polypropylene casters: 2 swivel, 2 rigid.
- Easy assembly. Ships via UPS.

SPECIFY COLOR: Red or Gray

MODEL NO.	DIMENSIONS L x W x H	LOAD CAPACITY	SHELF QTY.	WT. (LBS.)	PRICE EACH	
					1	3+
H-591	34 x 16 x 32"	800 lbs.	2	44	\$140	\$135
H-592	40 x 24 x 32"				175	170

# RUBBERMAID® UTILITY CARTS

Rounded edges won't damage walls. Lightweight and easy to maneuver.

- Ergonomic handle design. • Convenient tray for parts and tools.
- Built-in tool holster with tool/accessory hooks and cord wrap.
- Tough structural foam won't rust, chip or dent.
- Easy to clean – Maintenance free. • 2½" deep trays are 19¾" apart.
- Non-marking 5" casters: 2 swivel, 2 rigid.
- Easy assembly. Ships via UPS. • Replacement casters, see [uline.com](http://uline.com)



SPECIFY COLOR:  Black  Beige

MODEL NO.	DIMENSIONS L x W x H	LOAD CAPACITY	SHELF QTY.	WT. (LBS.)	PRICE EACH	
					1	3+
H-2470*	39 x 17 x 33"	500 lbs.	2	31	\$195	\$185
H-2471	44 x 25 x 33"			42	225	215
H-2472▲	54 x 25 x 33"	750 lbs.	2	53	440	415

\* Tool/accessory hooks and cord wrap not included

▲ Black only

## WITH PNEUMATIC WHEELS

Roll easily over rough, uneven surfaces.

- Tough structural foam won't rust, chip or dent.
- 8" pneumatic casters.
- 2½" deep trays are 19¾" apart.
- Easy assembly. Ships via UPS.



MODEL NO.	DIMENSIONS L x W x H	LOAD CAPACITY	SHELF QTY.	WT. (LBS.)	PRICE EACH	
					1	3+
H-2473	44 x 25 x 37"	500 lbs.	2	65	\$515	\$505
H-2474	54 x 25 x 37"	750 lbs.		77	685	665

■ SHIPS UNASSEMBLED VIA MOTOR FREIGHT

## WITH DRAWER

Large lockable drawer keeps valuable tools and instruments safe.

- Won't pop open when moving.
- Non-marking 5" casters.
- Easy assembly. Ships via UPS.



MODEL NO.	DIMENSIONS L x W x H	LOAD CAPACITY	SHELF QTY.	WT. (LBS.)	PRICE EACH	
					1	3+
H-2475	44 x 26 x 33"	500 lbs.	2	55	\$320	\$300
H-2476	54 x 26 x 33"	750 lbs.		65	520	495

## FLAT SHELF CARTS

Easy to unload your heavy or oversized items.

- Built-in storage space for tools; electrical cord wrap.
- Non-marking 5" casters: 2 swivel, 2 rigid.
- Easy assembly. Ships via UPS.



\* Cord wrap not included

MODEL NO.	DIMENSIONS L x W x H	LOAD CAPACITY	SHELF QTY.	WT. (LBS.)	PRICE EACH	
					1	3+
H-2482*	39 x 17 x 33"	500 lbs.	2	30	\$235	\$225
H-2483	44 x 25 x 33"			40	260	250

## FLAT HANDLE CARTS

Low-profile handle won't get in your way. Built-in cup holder.

- Tough structural foam won't rust, chip or dent.
- 2⅝" deep trays are 18⅞" apart.
- Non-marking 5" casters: 2 swivel, 2 rigid.
- Easy assembly. Ships via UPS.



▲ Black only

SPECIFY COLOR:  Black  Beige

MODEL NO.	DIMENSIONS L x W x H	LOAD CAPACITY	SHELF QTY.	WT. (LBS.)	PRICE EACH	
					1	3+
H-965▲	40 x 18 x 33"	500 lbs.	2	31	\$195	\$185
H-1066	46 x 26 x 33"			43	225	215



## MOBILE WORKCENTER



Make repairs anywhere with a workbench on wheels.

- 5 drawers keep parts and tools organized.
- 27 x 14" polyethylene work surface.
- Removable locking bar for added security.

- Non-marking 4" casters: 2 swivel with brake, 2 rigid.

RUBBERMAID®

SHIPS ASSEMBLED VIA MOTOR FREIGHT

MODEL NO.	DESCRIPTION	DIMENSIONS L x W x H	LOAD CAPACITY	WT. (LBS.)	PRICE EACH	
					1	3+
H-1198	5 Drawer	32 x 21 x 33"	250 lbs.	69	\$495	\$475

## TRADEMASTER® CART



Power, storage and a workplace all in one.

- Extra large 36 x 24" work surface with built-in cupholder.
- 4 drawers, cabinet with 3-position adjustable shelf.
- Built-in 3-outlet surge protector with 10' cord.

- Non-marking 5" casters: 2 swivel with brake, 2 rigid.

UL LISTED. CSA CERTIFIED.

SHIPS UNASSEMBLED VIA MOTOR FREIGHT

MODEL NO.	DESCRIPTION	DIMENSIONS L x W x H	LOAD CAPACITY	WT. (LBS.)	PRICE EACH	
					1	3+
H-4287	4 Drawer w/ Cabinet	50 x 27 x 39"	750 lbs.	123	\$1,030	\$995

## ULINE 3-SHELF UTILITY CARTS



Move a lot of product with this lightweight 3-shelf cart.

- Shelves are 12" apart and 1/4" deep.
- Sturdy, maintenance-free structural foam.
- 4" non-marking swivel casters: 2 locking.



Lipped – 2¾" deep shelves keep loads in place.

SPECIFY COLOR: Black, Red or Blue

EASY ASSEMBLY. SHIPS VIA UPS.

MODEL NO.	DESCRIPTION	DIMENSIONS L x W x H	LOAD CAPACITY	WT. (LBS.)	PRICE EACH	
					1	3+
H-5007	Flat	27 x 18 x 34"	300 lbs.	22	\$135	\$125
H-6173	Lipped	28 x 19 x 39"		25	145	135

## CLASSIC FLAT SHELF CARTS



Popular Rubbermaid® cart. Flat top for easy loading.

- Built-in storage space for tools.
- Convenient work surface.
- Tough structural foam won't rust, chip or dent.

- 5" non-marking casters: 2 swivel, 2 rigid.

RUBBERMAID®

MODEL NO.	DIMENSIONS L x W x H	LOAD CAPACITY	SHELF QTY.	WT. (LBS.)	PRICE EACH	
					1	3+
H-1044	38 x 19 x 33"	500 lbs.	2	33	\$235	\$225
H-1063	44 x 25 x 33"			43	260	250

EASY ASSEMBLY. SHIPS VIA UPS.

## MOBILE WORKSTATIONS

Bins and Shelving, see pages 490-499.



Excellent portable workstation with convertible top for assembly or transport.

- Non-marking 5" casters: 2 locking swivel, 2 rigid.

- Tray compartments hold pens and tools.

- Tough structural foam resists dents.



BIN CART W/ BINS SPECIFY BIN COLOR: Blue, Red, Green, White, Yellow, Clear or Black

MODEL NO.	BIN SIZE L x W x H	BINS/ CART	WT. (LBS.)	PRICE EACH	
				1	2+
H-1496	11 x 5½ x 5"	36	108	\$550	\$530
H-1910	11 x 8 x 7"	16	107	545	525
H-1497	11 x 11 x 5"	18	104	525	505

BIN CART

SHIPS UNASSEMBLED VIA MOTOR FREIGHT

MODEL NO.	SIZE L x W x H	LOAD CAPACITY	WT. (LBS.)	PRICE EACH	
				1	2+
H-1495	45 x 24 x 35"	400 lbs.	86	\$415	\$405

# RUBBERMAID® SERVICE CARTS

Versatile carts are used successfully in food service, material handling and office environments.



- Easy-to-clean, smooth plastic shelves are 12" apart.
- 1" deep trays with open front for easy loading.
- Black for offices and schools or White for restaurants and hospitality.
- 4" quiet rubber casters.



SPECIFY COLOR: Black or White EASY ASSEMBLY. SHIPS VIA UPS.

MODEL NO.	DIMENSIONS L x W x H	LOAD CAPACITY	SHELF QTY.	WT. (LBS.)	PRICE EACH	
					1	3+
H-1053	34 x 19 x 38"	200 lbs.	3	30	\$265	\$255
H-1852	41 x 20 x 38"	300 lbs.	3	39	315	305
H-2059*	41 x 20 x 51"	300 lbs.	4	52	445	430

\* Black only

## ULINE SERVICE CARTS



Contain spills with 3/4" shelf lip on all four sides.

- Recommended for kitchens, cafeterias and breakrooms.
- Easy-to-clean shelves are 11 3/8" apart.
- Pivots quickly and smoothly. Ergonomic push handles.
- 4" quiet rubber casters.

EASY ASSEMBLY. SHIPS VIA UPS.

MODEL NO.	DIMENSIONS L x W x H	LOAD CAPACITY	SHELF QTY.	WT. (LBS.)	PRICE EACH	
					1	3+
H-7435	34 x 20 x 38"	300 lbs.	3	28	\$200	\$190
H-7436	40 x 20 x 38"			38	240	230

## SERVICE CART WITH CABINET

Transport and store instruments and supplies.

- 11" high locking cabinet.
- Convenient sliding tray.
- Easy-to-clean, smooth plastic shelves.
- 1" deep trays are 12" apart.
- 4" quiet rubber casters.



RUBBERMAID®

EASY ASSEMBLY. SHIPS VIA UPS.

MODEL NO.	DIMENSIONS L x W x H	LOAD CAPACITY	SHELF QTY.	WT. (LBS.)	PRICE EACH	
					1	3+
H-2060	41 x 20 x 38"	300 lbs.	2	52	\$525	\$510

## ULINE RECEIVING CARTS



Label packages, store tools and check in shipments with ease. Used at Uline when the containers arrive. Portable and moves easily.

- Large 27 x 27" acrylic work surface. Powder-coated steel frame.
- Three 25 x 10" exterior shelves and three 27 x 7" interior shelves.
- Ventilated locking cabinet keeps tools and electronics safe.

SPECIFY COLOR: Red or Black SHIPS UNASSEMBLED VIA MOTOR FREIGHT

MODEL NO.	DIMENSIONS L x W x H	LOAD CAPACITY	SHELF QTY.	WT. (LBS.)	PRICE EACH	
					1	3+
H-9022	31 x 27 x 44"	500 lbs.	6	127	\$425	\$410

- 5" polyurethane casters. Smooth "cam action." 2 swivel with brake, 2 rigid.



## MOBILE COMPUTER CABINET



Fully-enclosed workstation protects computer from dust and theft.

- Holds most flat screen monitors up to 23". Shatter-resistant acrylic window.
- Ventilated steel construction. Large bottom cabinet with adjustable slide-out shelf.
- Locking keyboard drawer and access doors.
- 5" non-marking rubber swivel casters: 2 locking.

MODEL NO.	DIMENSIONS L x W x H	LOAD CAPACITY	SHELF QTY.	WT. (LBS.)	PRICE EACH	
					1	3+
H-7545	23 x 25 x 64"	400 lbs.	2	103	\$495	\$485

SHIPS UNASSEMBLED VIA MOTOR FREIGHT

## MOBILE AV CABINET



Rolling AV storage locks to protect projectors and printers.

- Powder-coated steel with laminate wood top.
- Locking cabinet.
- Slide-out shelf adjusts in 2" increments.
- Grommets for easy cable management.
- Ventilated rear door.
- 5" rubber swivel casters: 2 locking.

MODEL NO.	DIMENSIONS L x W x H	LOAD CAPACITY	SHELF QTY.	WT. (LBS.)	PRICE EACH	
					1	3+
H-7549	23 x 25 x 35"	400 lbs.	2	80	\$295	\$285

SHIPS UNASSEMBLED VIA MOTOR FREIGHT

## ECONOMY AV CARTS

Move computers and AV equipment between meetings.



H-7550

- Includes slide-out keyboard tray, 3-outlet UL/CSA Listed power strip and 15' cord.
- Powder-coated steel.
- 4" rubber swivel casters: 2 locking.

H-7551 – Locking bottom cabinet.



H-7551

MODEL NO.	DIMENSIONS L x W x H	LOAD CAPACITY	SHELF QTY.	WT. (LBS.)	PRICE EACH	
					1	3+
H-7550	26 x 20 x 29-42"	400 lbs.	3	43	\$190	\$180
H-7551			2	54	240	230

SHIPS UNASSEMBLED VIA UPS

## WIRE COMPUTER CART



Easily move computers around the warehouse, office or hospital.

- Includes pull-out keyboard shelf with wrist pad.
- Open wire resists dirt and dust buildup.
- Shelves adjust in 1" increments.
- Smooth rolling on 5" locking swivel casters.

MODEL NO.	DIMENSIONS L x W x H	LOAD CAPACITY	SHELF QTY.	WT. (LBS.)	PRICE EACH	
					1	3+
H-7555	30 x 24 x 40"	1,000 lbs.	3	59	\$230	\$220

SHIPS UNASSEMBLED VIA UPS

## TABLET CHARGING CART

Keep up to 30 tablets or laptops secure, charged and ready to use.

- Ventilated steel cabinet on all sides.
- Lock and key system secures both front and back doors.
- Two 15-outlet power strips on rear panel with 10' power cord.
- 4" polyurethane swivel casters: 2 locking.

UL/C-UL LISTED

EASY ASSEMBLY. SHIPS VIA MOTOR FREIGHT.

MODEL NO.	DIMENSIONS L x W x H	DEVICE CAPACITY	SHELF QTY.	WT. (LBS.)	PRICE EACH	
					1	3+
H-5489	25 x 21 x 38"	30	3	116	\$765	\$745





# COMPUTER CARTS

Adjustable height workstation moves easily from project to project.

- Includes slide-out keyboard tray, 3-outlet UL/CSA Listed power strip and 15' cord.
- Top shelf has a safety mat and retaining lip.
- Welded steel with durable powder-coat finish.
- 4" rubber swivel casters: 2 locking.



EASY ASSEMBLY. SHIPS VIA UPS.

MODEL NO.	DIMENSIONS L x W x H	LOAD CAPACITY	SHELF QTY.	WT. (LBS.)	PRICE EACH	
					1	3+
H-4607	26 x 20 x 29 - 42"	400 lbs.	3	42	\$230	\$220
H-6746	34 x 20 x 29 - 42"				305	295

SPECIFY COLOR: Black



Red



Blue



# AV CARTS

Store, move and use valuable AV equipment.

- Top shelf with safety mat adjusts in 2" increments.
- Includes locking bottom cabinet, 3-outlet UL/CSA Listed power strip and 15' cord.
- Welded steel construction with powder-coat finish.
- 4" rubber swivel casters: 2 locking.



SHIPS VIA MOTOR FREIGHT

EASY ASSEMBLY. SHIPS VIA UPS.

MODEL NO.	DIMENSIONS L x W x H	LOAD CAPACITY	SHELF QTY.	WT. (LBS.)	PRICE EACH	
					1	3+
H-5003	26 x 20 x 29 - 42"	400 lbs.	2	52	\$270	\$260
H-6747	34 x 20 x 29 - 42"				440	420

SPECIFY COLOR: Black



Red



Blue



# WORKSTATION CART

Multi-level surface for working on laptops, paperwork and presentations.

- Recommended for nurse stations, IT specialists and classrooms.
- Laminate wood shelves offer a smooth writing surface.
- Powder-coated steel frame. Adjusts for sitting or standing.
- 3" non-marking polypropylene swivel casters: 2 locking.



EASY ASSEMBLY. SHIPS VIA UPS.

MODEL NO.	DIMENSIONS L x W x H	LOAD CAPACITY	SHELF QTY.	WT. (LBS.)	PRICE EACH	
					1	3+
H-5486	31 x 24 x 39 - 45"	200 lbs.	3	40	\$185	\$175

# FLAT SCREEN CART

Easily move flat panel monitors for presentations or training.

- Holds most 32-60" flat screens. Main columns hide cables.
- Height adjusts in 2" increments.
- 2" non-marking, locking swivel casters.



Optional Shelf – Holds computers, tablets and Blu-ray players.

EASY ASSEMBLY. SHIPS VIA UPS.

MODEL NO.	DIMENSIONS L x W x H	LOAD CAPACITY	WT. (LBS.)	PRICE EACH	
				1	3+
H-5487	33 x 29 x 47 - 67"	100 lbs.	44	\$245	\$235
H-5488	Optional Shelf – 19 x 11"		11	57	55

# PLASTIC AV CARTS

Roll AV and computer equipment quietly through offices and classrooms.

- Tough, lightweight structural foam resists dents and chips.
- Includes steel slide-out keyboard tray, 3-outlet UL/CSA Listed power strip and 15' cord.

SPECIFY COLOR: Black or Black/Red

MODEL NO.	DIMENSIONS L x W x H	LOAD CAPACITY	SHELF QTY.	WT. (LBS.)	PRICE EACH	
					1	3+
H-7459	27 x 18 x 34"	300 lbs.	3	30	\$195	\$185
H-7460					290	280

EASY ASSEMBLY. SHIPS VIA UPS.

- 4" rubber swivel casters: 2 locking.

H-7460 – Includes locking steel bottom cabinet.



H-7459



H-7460

## ULINE SIDE PANEL PLATFORM TRUCKS



Easy to stock and transport totes, boxes and bins.

- Removable 2 x 2" steel mesh panels, 22" high.
- Quiet wood deck.
- Durable, 12 gauge steel stands up to years of use.
- 5" non-marking casters: 2 swivel, 2 rigid.

MODEL NO.	DECK SIZE W x L	LOAD CAPACITY	WHEEL TYPE	WT. (LBS.)	PRICE EACH	
					1	2+
H-4167	24 x 48"	2,000 lbs.	Polyurethane	137	\$805	\$795
H-4168	30 x 60"				1,025	1,005

SHIPS UNASSEMBLED VIA MOTOR FREIGHT

## ULINE STEEL BOX TRUCK



Haul the heaviest metal parts, castings or scrap.

- Heavy duty, all-welded steel with a giant 3,000 lb. capacity.
- Mesh sides provide visibility and airflow.
- Curved handle for safe, easy transport.
- 6" casters: 2 swivel, 2 rigid.

MODEL NO.	DIMENSIONS L x W x H	LOAD CAPACITY	WHEEL TYPE	WT. (LBS.)	PRICE EACH	
					1	2+
H-4878	48 x 30 x 34"	3,000 lbs.	Polyurethane	120	\$645	\$625

SHIPS ASSEMBLED VIA MOTOR FREIGHT

## WELDED STOCK PICKER CARTS

Easy and safe retrieval for heavy parts and small engines.

- See-through mesh panels and adjustable top shelf make picking easy.
- Curved handle for safe transport.
- 12 gauge welded steel.
- 6" casters: 2 lockable swivel, 2 rigid.

Additional shelves, see [uline.com](http://uline.com)



MODEL NO.	DIMENSIONS L x W x H	LOAD CAPACITY	WHEEL TYPE	WT. (LBS.)	PRICE EACH	
					1	3+
H-6125	48 x 24 x 58"	3,000 lbs.	Polyurethane	174	\$835	\$815
H-6126	60 x 30 x 58"				980	960

SHIPS ASSEMBLED VIA MOTOR FREIGHT

## WELDED SECURITY CARTS

Transport valuable tools and equipment while providing security.

- All-welded steel construction. Lockable double doors.
- See-through mesh panels for visibility and ventilation.
- Solid steel shelf adjusts in 2½" increments.
- 6" casters: 2 lockable swivel, 2 rigid.



SPECIFY COLOR: Red or Blue



MODEL NO.	DIMENSIONS L x W x H	LOAD CAPACITY	WHEEL TYPE	WT. (LBS.)	PRICE EACH	
					1	3+
H-6128	48 x 24 x 58"	3,000 lbs.	Polyurethane	244	\$1,330	\$1,310
H-6129	60 x 30 x 58"				1,490	1,460

Additional shelves, see [uline.com](http://uline.com)

SHIPS ASSEMBLED VIA MOTOR FREIGHT

# ULINE WELDED STEEL CARTS

Heavy items move smoothly and silently.

- No bolts to work loose year after year.
- All-welded, powder-coated 12-gauge steel.
- **Lipped Shelf** – 3" deep on 2-shelf carts, 1½" deep on 3-shelf carts.
- 5" polyurethane casters: 2 swivel, 2 rigid.



SHIPS ASSEMBLED VIA MOTOR FREIGHT

MODEL NO.	DIMENSIONS L x W x H	LOAD CAPACITY	SHELF QTY.	WT. (LBS.)	PRICE EACH	
					1	3+
H-2558	36 x 18 x 35"	1,200 lbs.	2	71	\$365	\$350
H-2559	42 x 24 x 35"				425	410
H-4155	38 x 18 x 35"	1,200 lbs.	3	87	470	455
H-4156	42 x 24 x 35"				545	530

## JUMBO

Big Dog. Moves engines and heavy warehouse items.

- Floor lock secures cart when loading.
- 8" rubber casters: 2 swivel, 2 rigid.



FLAT SHELF

### FLAT SHELF

Unload heavy, oversized items with ease.

- Welded 12-gauge steel.
- 1½" deep bottom shelf.
- No bolts to work loose year after year.
- 5" polyurethane casters: 2 locking swivel, 2 rigid.



JUMBO

### FLAT SHELF

SHIPS ASSEMBLED VIA MOTOR FREIGHT

MODEL NO.	DIMENSIONS L x W x H	LOAD CAPACITY	SHELF QTY.	WT. (LBS.)	PRICE EACH	
					1	3+
H-3036	38 x 18 x 35"	1,200 lbs.	2	65	\$365	\$350
H-3037	42 x 24 x 35"				425	410

### JUMBO

SHIPS ASSEMBLED VIA MOTOR FREIGHT

MODEL NO.	DIMENSIONS L x W x H	LOAD CAPACITY	SHELF QTY.	WT. (LBS.)	PRICE EACH	
					1	3+
H-4984	54 x 24 x 36"	2,400 lbs.	2	157	\$740	\$715
H-4985	66 x 30 x 36"				915	890

# WELDED STAINLESS STEEL CARTS

Recommended for sanitary environments including labs, hospitals and restaurants.

- All-welded, corrosion-resistant stainless steel.
- Lipped shelves, 1½" deep. • Type 430.
- 5" polyurethane casters: 2 swivel, 2 rigid.
- 2 Shelf – Shelves are 25" apart for supplies.
- 3 Shelf – Shelves are 11" apart for trays and dishes.



### 2 SHELF

SHIPS ASSEMBLED VIA MOTOR FREIGHT

MODEL NO.	DIMENSIONS L x W x H	LOAD CAPACITY	SHELF QTY.	WT. (LBS.)	PRICE EACH	
					1	3+
H-3351	36 x 18 x 35"	1,200 lbs.	2	42	\$620	\$600
H-3352	42 x 24 x 35"				695	675

### 3 SHELF

SHIPS ASSEMBLED VIA MOTOR FREIGHT

MODEL NO.	DIMENSIONS L x W x H	LOAD CAPACITY	SHELF QTY.	WT. (LBS.)	PRICE EACH	
					1	3+
H-5546	36 x 18 x 35"	1,200 lbs.	3	66	\$800	\$775
H-5547	42 x 24 x 35"				900	875



# WORK HEIGHT PLATFORM TRUCKS

Transfer heavy parts from shelf to cart without bending or straining.



- All-welded steel frame with gray powder-coat finish.
- Removable handle for oversized items.
- 5" non-marking casters: 2 swivel, 2 rigid.



**Wood Deck** – Use in shipping areas and tool shops. Quiet 1" hardwood absorbs impact. 27" deck height.

**Steel Deck** – For workshops and manufacturing. Strong 12 gauge steel deck. 25" deck height.

MODEL NO.	DECK SIZE W x L	LOAD CAPACITY	WHEEL TYPE	WT. (LBS.)	PRICE EACH	
					1	2+
					H-4924	24 x 48"
H-4925	30 x 60"	815	795			

MODEL NO.	DECK SIZE W x L	LOAD CAPACITY	WHEEL TYPE	WT. (LBS.)	PRICE EACH	
					1	2+
					H-4940	24 x 48"
H-4941	30 x 60"	615	595			

## DRYWALL CART

High-capacity cart for hauling drywall, glass or wood.



- Sloped deck to prevent load from slipping.
- Heavy-duty steel construction.
- 8" polyurethane swivel casters: 2 locking.



MODEL NO.	DIMENSIONS W x L	USABLE DECK W x L	UPRIGHT HEIGHT	LOAD CAPACITY	WT. (LBS.)	PRICE EACH	
						1	2+
H-7442	23 x 50"	12 x 44"	36"	3,000 lbs.	90	\$310	\$290

SHIPS UNASSEMBLED VIA MOTOR FREIGHT

## U-BOAT TRUCKS

Narrow design for walk-in freezers and restaurant pantries.

- Lightweight aluminum construction. Easy to control.
- Durable all-welded diamond tread deck for heavy loads.
- 2 rigid 6" load casters, 4 swivel 5" casters.



MODEL NO.	DECK SIZE W x L	LOAD CAPACITY	WHEEL TYPE	WT. (LBS.)	PRICE EACH	
					1	2+
					H-6842	16 x 60"
H-7443	24 x 60"	515	495			

SHIPS UNASSEMBLED VIA MOTOR FREIGHT

## APPLIANCE HAND TRUCKS

Easily move heavy or bulky items up and down stairs.

- Heavy-duty ratchet tightener secures loads; eliminates slips and shuffling.
- Thick, non-marking rubber pads on all contact surfaces.
- Stair climbers glide smoothly up and down stairs and over curbs.

**H-5047** – Lighter capacity. 2-wheel design.

**H-1387** – Double-welded steel frame. Foot release converts to 4 wheels.

SHIPS ASSEMBLED VIA MOTOR FREIGHT

MODEL NO.	RECOMMENDED USE	LOAD CAPACITY	HANDLE TYPE	WHEEL TYPE	NOSE PLATE	HT.	WT. (LBS.)	PRICE EACH	
								1	3+
H-5047	Appliances	750 lbs.	Dual	8" Rubber	24 x 5"	59"	62	\$285	\$270
H-1387	Vending Machines	1,200 lbs.						535	515



H-5047



Specialty Hand Trucks, see uline.com

# PANEL TRUCKS

Move artwork, tables or plywood with ease.

- Removable uprights fit any size load.
- Rugged steel supports handle any cargo.

**Open Deck** – Lightweight and easy to use. 11" space between uprights.

**Carpeted Deck** – Padded surface for scratch-free loading and unloading. 11" space between uprights.

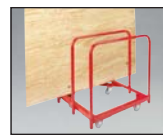

H-3173



H-6700



H-3174

■ SHIPS UNASSEMBLED VIA MOTOR FREIGHT

MODEL NO.	DESCRIPTION	DECK SIZE W x L	LOAD CAPACITY	WHEEL TYPE	WT. (LBS.)	PRICE EACH	
						1	2+
H-3173	Open Deck	27 x 30"	1,000 lbs.	5" Polyurethane	65	\$235	\$225
■H-3174	Carpeted				75	255	245
■H-6700*	Carpeted	30 x 60"			110	410	390

\* 13" space between uprights

# A-FRAME PANEL TRUCKS

Move large sheets of plywood, drywall and steel easily.

- 1" retaining lip on each side keeps panels from sliding off.
- All-welded 12 gauge steel construction.
- 6" polyurethane casters: 2 swivel, 2 rigid.



1 TON CAPACITY

SHIPS ASSEMBLED VIA MOTOR FREIGHT

MODEL NO.	DECK SIZE W x L	USABLE DECK/SIDE	UPRIGHT HEIGHT	LOAD CAPACITY	WT. (LBS.)	PRICE EACH	
						1	2+
H-3406	24 x 48"	6"	48"	2,000 lbs.	139	\$615	\$595
H-3407	30 x 60"	9"				172	730

# ADJUSTABLE PANEL TRUCKS

Customize your truck to fit any size panel or sheet.

- 7 socket positions for maximum versatility.
- Includes 2 of each upright height: 12", 24" and 36".
- 6" polyurethane casters: 2 swivel, 2 rigid.



1 TON CAPACITY

SHIPS UNASSEMBLED VIA MOTOR FREIGHT

MODEL NO.	DECK SIZE W x L	UPRIGHT HEIGHT	LOAD CAPACITY	WT. (LBS.)	PRICE EACH	
					1	2+
H-4944	24 x 48"	12-36"	2,000 lbs.	145	\$460	\$435
H-4945	30 x 60"				178	515

# METAL PLATFORM TRUCKS

Sturdy and economical for warehouses, receiving docks and manufacturing plants.

- 13 gauge steel deck. • Durable, red powder-coat finish is easy to spot.
- Removable handle fits either end. • Smooth rolling 6" casters: 2 swivel, 2 rigid.

ADDITIONAL HANDLES

MODEL NO.	DECK SIZE W x L	LOAD CAPACITY	WHEEL TYPE	WT. (LBS.)	PRICE EACH		MODEL NO.	PRICE EACH	
					1	2+		1	2+
H-2666	24 x 48"	2,000 lbs.	Polyolefin	78	\$285	\$275	H-4972	\$40	\$38
H-8154	30 x 48"	2,000 lbs.	Polyolefin	93	330	315	H-4973	46	44
H-2667	30 x 60"				102	350			
H-6708	36 x 72"	2,000 lbs.	Polyolefin	131	440	420	H-6709	51	49

SHIPS UNASSEMBLED VIA MOTOR FREIGHT





## U-BOAT PLATFORM TRUCKS

Narrow truck maneuvers easily in tight aisles and spaces.

- Transport small packages in warehouses, grocery aisles and stockrooms.
- Tall, removable end panels keep loads from sliding off.
- All-welded steel diamond tread deck.
- 2 rigid 8" load casters, 4 swivel 4" casters.



Optional Shelves – Slip onto end panels. No screws needed.

SPECIFY COLOR: Green or Red

SHELVES

SHIPS UNASSEMBLED VIA MOTOR FREIGHT

MODEL NO.	DECK SIZE W x L	LOAD CAPACITY	WT. (LBS.)	PRICE EACH		MODEL NO.	LOAD CAPACITY	WT. (LBS.)	PRICE EACH	
				1	2+				1	2+
H-4825	16 x 48"	1,000 lbs.	110	\$280	\$270	H-4825-SHELF	300 lbs.	31	\$85	\$80
H-4826	24 x 48"		140	355	345	H-4826-SHELF		44	95	90
H-1825	16 x 60"	1,800 lbs.	122	295	285	H-1825-SHELF	300 lbs.	38	90	85
H-2637	24 x 60"		155	375	365	H-2637-SHELF		54	105	100

## HANDI-MOVERS



Unload your car. Easily move boxes and files in office or warehouse.

- Wraparound rubber bumper prevents damage to walls.
- Portability, ease of use makes this a continual best seller.



SHIPS UNASSEMBLED VIA UPS

MODEL NO.	DECK SIZE W x L	LOAD CAPACITY	WHEEL TYPE	WT. (LBS.)	PRICE EACH	
					1	3+
H-115	19 x 29"	400 lbs.	4" Rubber	29	\$110	\$105
H-180	23 x 35"	600 lbs.	5" Rubber	44	160	150

## BIG WHEEL HANDI-MOVER



Push heavy loads over uneven surfaces.

- Rubber bumper prevents damage to walls.
- 8" shock absorbing pneumatic wheels.
- Secure items using welded bottom hooks.
- 2 swivel, 2 rigid casters.

SHIPS UNASSEMBLED VIA UPS

MODEL NO.	DECK SIZE W x L	LOAD CAPACITY	WHEEL TYPE	WT. (LBS.)	PRICE EACH	
					1	3+
H-2176	23 x 35"	600 lbs.	8" Pneumatic	69	\$290	\$280

## STAINLESS STEEL LIFT TABLES



STANDARD

Giant back saver. Recommended for laboratories and food service industries. Easy to wash down.

- Durable, type 304 stainless steel frame and platform withstands the harshest environments.
- Foot pump hydraulically raises platform.
- Polyurethane casters: 2 swivel with brake, 2 rigid.

Double Scissor – Lifts higher for easy shelf stocking.



DOUBLE SCISSOR

EASY ASSEMBLY. SHIPS VIA MOTOR FREIGHT.

MODEL NO.	DESCRIPTION	PLATFORM L x W	LOAD CAPACITY	HEIGHT LOWERED	HEIGHT RAISED	WHEEL DIAMETER	WT. (LBS.)	PRICE EACH
H-8173	Standard	32 x 20"	660 lbs.	11"	35"	5"	165	\$1,850
H-8174	Double Scissor	36 x 20"	770 lbs.	13¾"	51"	5"	223	2,050



## WELDED PLATFORM TRUCKS

Uline's recommended choice for an all-purpose, long-lasting warehouse platform truck.

- Strong 12 gauge steel deck.
- Rolls smoothly and maneuvers easily.
- **Permanent handle** won't "pop out."
- 8" casters: 2 swivel, 2 rigid.



SPECIFY COLOR: Green or Blue

SHIPS ASSEMBLED VIA MOTOR FREIGHT

MODEL NO.	DECK SIZE W x L	LOAD CAPACITY	WHEEL TYPE	WT. (LBS.)	PRICE EACH	
					1	2+
H-61	24 x 48"	2,000 lbs.	Rubber	136	\$540	\$520
H-6172	30 x 48"			151	595	575
H-62	30 x 60"			166	645	625
H-1824	36 x 72"			221	810	785

## WOOD PLATFORM TRUCKS

Whisper smooth, ultra quiet.

- Used in warehouses, industrial and office spaces.
- Tough wood deck. Underside reinforced with 4 cross boards.
- Welded steel handle.
- 8" casters: 2 swivel, 2 rigid.



SHIPS ASSEMBLED VIA MOTOR FREIGHT

MODEL NO.	DECK SIZE W x L	LOAD CAPACITY	WHEEL TYPE	WT. (LBS.)	PRICE EACH	
					1	2+
H-1191	24 x 48"	2,000 lbs.	Rubber	78	\$370	\$355
H-1192	30 x 60"			99	445	425
H-1561	36 x 72"			112	535	515

## DELUXE WOOD PLATFORM TRUCKS

Better protection for your investment. Metal frame on all sides.

- High capacity truck moves castings, motors and steel strapping with ease.
- Sockets on both ends. Optional second handle helps keep loads in place.
- 8" non-marking casters: 2 swivel, 2 rigid.

SHIPS ASSEMBLED VIA MOTOR FREIGHT

MODEL NO.	DECK SIZE W x L	LOAD CAPACITY	WHEEL TYPE	WT. (LBS.)	PRICE EACH	
					1	2+
H-4147	24 x 48"	2,500 lbs.	Polyurethane	105	\$540	\$520
H-4148	30 x 60"			127	620	595
H-4149	36 x 72"			159	740	710



## ALUMINUM PLATFORM TRUCKS

Excels in humid, wet conditions like commercial kitchens and food processing plants.

- Lightweight, corrosion-resistant aluminum with welded box channel frame.
- Nonslip diamond tread deck.
- Removable handle fits either end.
- 8" casters: 2 swivel, 2 rigid.



SHIPS UNASSEMBLED VIA MOTOR FREIGHT

MODEL NO.	DECK SIZE W x L	LOAD CAPACITY	WHEEL TYPE	WT. (LBS.)	PRICE EACH	
					1	2+
H-2529	24 x 48"	2,000 lbs.	Rubber	57	\$505	\$485
■H-2530	30 x 60"			68	585	560
H-3373	24 x 48"	1,200 lbs.	Pneumatic	63	525	505
■H-3374	30 x 60"			74	605	580

## PLASTIC PLATFORM TRUCKS

Virtually maintenance free. Use in any office, warehouse or shop.

- Solid plastic deck won't warp, chip, dent or rust.
- Rounded corners protect walls and furniture.
- 8" casters: 2 swivel, 2 rigid.



SHIPS UNASSEMBLED VIA MOTOR FREIGHT

MODEL NO.	DECK SIZE W x L	LOAD CAPACITY	WHEEL TYPE	WT. (LBS.)	PRICE EACH	
					1	2+
H-10924	24 x 48"	2,000 lbs.	Polyolefin	70	\$365	\$350
H-10926	30 x 60"			84	440	420
H-10923	24 x 48"	1,200 lbs.	Pneumatic	77	410	390
H-10925	30 x 60"			94	485	465

# CASTERS

FOR CARTS



Polyolefin, Swivel



Rubber, Swivel with Brake



Polyurethane, Rigid

Smooth-rolling replacements for carts, dollies and poly box trucks.

- Swivel casters have hardened double-ball raceways.
- Polyolefin – Lightweight. Easy to push over smooth surfaces.
- Rubber – Non-marking and quiet. Rolls easily on tile and linoleum.
- Polyurethane – Long lasting and chemical resistant. Non-marking.
- Bolt hole spacing: 1 3/4 x 3". Additional info, see [uline.com](http://uline.com)

MODEL NO.	DESCRIPTION	CAPACITY (LBS.)	SIZE DIAM. x W	OVERALL HEIGHT	SWIVEL		SWIVEL W/ BRAKE		RIGID		FITS ULINE TRUCK
					PRICE EACH (MIN. 2)		PRICE EACH (MIN. 2)		PRICE EACH (MIN. 2)		
					2	4+	2	4+	2	4+	
H-5535	Polyolefin	275	4 x 1 1/4"	5 1/4"	\$11	\$10	\$12	\$11	\$9	\$8	H-1811
H-5536		300	5 x 1 1/4"	6 1/4"	12	11	13	12	10	9	H-592
H-5537	Rubber	275	4 x 1 1/4"	5 1/4"	13	12	14	13	11	10	H-3318
H-5538		300	5 x 1 1/4"	6 1/4"	14	13	15	14	12	11	H-4287
H-5539	Polyurethane	275	4 x 1 1/4"	5 1/4"	15	14	16	15	13	12	H-1956
H-5540		300	5 x 1 1/4"	6 1/4"	16	15	17	16	14	13	H-3840

# HEAVY DUTY CASTERS

FOR PLATFORM TRUCKS



Polyolefin, Swivel



Rubber, Swivel with Brake



Polyurethane, Rigid

Keep platform, u-boat and panel trucks rolling smoothly with replacement casters.

- Swivel casters have hardened double-ball raceways.
- Polyolefin – Withstands harsh indoor and outdoor use.
- Rubber – Rolls easily on tile, linoleum, brick and carpet.
- Polyurethane – Highest weight capacity. Non-marking and chemical resistant.
- Bolt hole spacing of 2 5/8 x 3 5/8" to 3 x 3". Additional info, see [uline.com](http://uline.com)

MODEL NO.	DESCRIPTION	CAPACITY (LBS.)	SIZE DIAM. x W	OVERALL HEIGHT	SWIVEL		SWIVEL W/ BRAKE		RIGID		FITS ULINE TRUCK
					PRICE EACH (MIN. 2)		PRICE EACH (MIN. 2)		PRICE EACH (MIN. 2)		
					2	4+	2	4+	2	4+	
H-3322	Polyolefin	700	6 x 2"	7 1/2"	\$22	\$21	\$24	\$23	\$18	\$17	H-2667
H-3323		900	8 x 2"	9 1/2"	26	25	28	27	23	22	H-1827
H-3326	Rubber	410	6 x 2"	7 1/2"	24	23	26	25	21	20	H-1191
H-3327		500	8 x 2"	9 1/2"	28	27	30	29	25	24	H-1192
H-4942	Polyurethane	800	6 x 2"	7 1/2"	27	26	29	28	24	23	H-6126
H-4943		1,000	8 x 2"	9 1/2"	33	32	35	34	30	29	H-4148



10" Swivel



8" Swivel with Brake



8" Rigid

# PNEUMATIC CASTERS

FOR PLATFORM TRUCKS AND UTILITY CARTS

Big, shock-absorbing wheels provide a quiet, cushioned ride.

- Precision ball bearings for smooth, effortless rolling.
- Tough 4-ply rubber resists wear and punctures.
- Bolt hole spacing of 2 5/8 x 3 5/8" to 3 x 3".
- Additional info, see [uline.com](http://uline.com)

SPECIFY COLOR: Gray or Black

MODEL NO.	DESCRIPTION	CAPACITY (LBS.)	SIZE DIAM. x W	OVERALL HEIGHT	SWIVEL		SWIVEL W/ BRAKE		RIGID		FITS ULINE TRUCK
					PRICE EACH (MIN. 2)		PRICE EACH (MIN. 2)		PRICE EACH (MIN. 2)		
					2	4+	2	4+	2	4+	
H-3328	4-Ply Rubber	310	8 x 2 1/2"	9 1/2"	\$47	\$44	\$54	\$51	\$44	\$40	H-2505
H-3329		470	10 x 4"	13"	81	76	N/A	N/A	75	70	H-2473

# HARDWOOD DOLLIES



The everyday dolly. Recommended for offices, schools and commercial movers.

- Carpeted ends provide cushioning and protect furniture from scuffing.
- Rubber ends are nonslip for heavier items like filing cabinets.



**BIG CHUBBY**

## STANDARD

MODEL NO.	DESC.	DIM. L x W	WHEEL TYPE	LOAD CAP. (LBS.)	WT. (LBS.)	PRICE EACH	
						1	4+
H-967	Carpeted	30 x 18"	3" Rubber	600	12	\$44	\$40
H-1791			4" Rubber	750	14	54	50
H-3318			4" Polyurethane	1,000	16	68	63
H-1104	Rubber	30 x 18"	3" Rubber	600	13	50	46
H-1792			4" Rubber	750	16	60	56

SHIPS ASSEMBLED VIA UPS

**Deluxe** – Extra-wide, carpeted ends to support your heaviest loads. 5" locking swivel casters.

## DELUXE

MODEL NO.	DESC.	DIM. L x W	WHEEL TYPE	LOAD CAP. (LBS.)	WT. (LBS.)	PRICE EACH	
						1	4+
H-9843	Carpeted	30 x 18"	5" Polyurethane	1,500	24	\$100	\$95
H-9844		36 x 24"				31	125

SHIPS ASSEMBLED VIA UPS

# SOLID TOP DOLLIES

Solid top supports heavy or small loads. Thick 7/8" hardwood carries cartons, boxes or crates.



- Bolts sunk below surface to prevent scuffing.
- Swivel casters safe for wood, tile and linoleum.
- Carpeted – Added protection for furniture.

MODEL NO.	DESC.	DIM. L x W	WHEEL TYPE	LOAD CAP. (LBS.)	WT. (LBS.)	PRICE EACH	
						1	4+
H-1543	Wood	30 x 18"	3" Rubber	900	20	\$59	\$55
H-1793			4" Rubber	1,000	22	68	63
H-3320	Carpeted	30 x 18"	3" Rubber	900	21	66	61
H-3321			4" Rubber	1,000	23	74	70

SHIPS ASSEMBLED VIA UPS

# HEAVY DUTY STEEL DOLLIES

Stable support for heavy parts and machinery in factories and warehouses.

- Flush 12 gauge steel deck design for easy loading and unloading.
- Hidden fasteners won't scratch cargo.
- Tow rod makes it easy to pull heavy loads.



MODEL NO.	DESC.	DIM. L x W	WHEEL TYPE	LOAD CAP. (LBS.)	WT. (LBS.)	PRICE EACH	
						1	4+
H-4819	Steel	30 x 18"	4" Polyolefin	2,000	48	\$145	\$135
H-4820		36 x 24"				61	175

SHIPS UNASSEMBLED VIA UPS

# FOLDING HAND TRUCKS

Incredible. Lightweight aluminum trucks weigh as little as 11 lbs.



- Compact folded size fits into cars, vans, even under desks.
- 19 x 12" nose plate. 42" high.
- H-2638 – 23 x 13" nose plate. 50" high.



Opens or folds up in seconds

SHIPS ASSEMBLED VIA UPS

MODEL NO.	LOAD CAPACITY (LBS.)	FOLDED DIMENSIONS H x W x D	WT. (LBS.)	PRICE EACH	
				1	3+
H-1787	100	33 x 19 x 3"	11	\$100	\$95
H-1201	175	30 x 19 x 2"	12	115	110
H-2638	275	40 x 24 x 3"	26	190	180

# PLASTIC DOLLY

Long-lasting, steel-reinforced plastic dolly for food service or hospitals.

- Durable polyethylene won't rot, warp or splinter.
- Rubber end pads cushion and grip loads.
- 4" polyolefin swivel casters.



SHIPS UNASSEMBLED VIA UPS

MODEL NO.	DESC.	DIM. L x W	WHEEL TYPE	LOAD CAP. (LBS.)	WT. (LBS.)	PRICE EACH	
						1	4+
H-1811	Rubber	30 x 18"	4" Polyolefin	1,200	22	\$125	\$115





## 4-SHELF CARTS

Lightweight inventory truck.

- Recommended for small warehouses or retail stockrooms.
- Durable steel construction. Powder-coated.
- 3" deep shelves are 13" apart. Adjustable.
- 5" polypropylene casters: 2 swivel, 2 rigid.

MODEL NO.	DIMENSIONS L x W x H	LOAD CAPACITY	SHELF QTY.	WT. (LBS.)	PRICE EACH	
					1	3+
H-8166	34 x 16 x 60"	800 lbs.	4	66	\$255	\$240
H-8167	40 x 24 x 60"			94	315	295

EASY ASSEMBLY. SHIPS VIA MOTOR FREIGHT.

## STOCK PICKING CARTS

Check off stock numbers as you move throughout the warehouse.

- Built-in 23 x 11" writing stand.
- All-welded 12-gauge steel construction.
- 1½" deep shelves are 25" apart.
- 5" polyurethane casters: 2 swivel, 2 rigid.



MODEL NO.	DIMENSIONS L x W x H	LOAD CAPACITY	SHELF QTY.	WT. (LBS.)	PRICE EACH	
					1	3+
H-3902	53 x 25 x 39"	1,200 lbs.	2	98	\$440	\$430
H-3903	65 x 25 x 39"			112	495	480

SHIPS ASSEMBLED VIA MOTOR FREIGHT



## TOTE PICKING CART

Pick orders and stock shelves. Used in mailrooms, warehouses and retail service centers.

- 3 slanted shelves for easy access to contents and product visibility.
- Handles on three sides to maneuver easily through aisles.
- Heavy-duty, powder-coated steel frame withstands daily use.
- 5" polyurethane casters: 2 rigid, 2 swivel with brake.

H-9094 – Includes 12 corrugated plastic totes. Holds up to 80 lbs. each.

\* SPECIFY TOTE COLOR: White, Blue, Red, Yellow, Green or Black

MODEL NO.	DESCRIPTION	DIMENSIONS L x W x H	SHELF DIM. L x W	LOAD CAPACITY	WT. (LBS.)	PRICE EACH	
						1	3+
H-9093	Cart Only	68 x 28 x 70"	58 x 16"	1,000 lbs.	108	\$445	\$435
H-9094*	Cart with Totes	Includes 12 Each 18 x 13 x 12" Totes			132	570	555

SHIPS UNASSEMBLED VIA MOTOR FREIGHT



## APPLIANCE HAND TRUCK

Lifts easily in and out of your truck or van.

- Recommended for moving appliances, vending machines and cabinets.
- Heavy-duty ratchet tightener secures loads.
- Large 24 x 5" nose plate.
- Rubber pads on all contact points.
- 60" high aluminum frame.
- Stair climbers glide easily over steps.

ALUMINUM

MODEL NO.	LOAD CAPACITY	HANDLE TYPE	WHEEL TYPE	HT.	WT. (LBS.)	PRICE EACH	
						1	3+
H-9099	550 lbs.	Dual	8" Rubber	60"	40	\$360	\$340

SHIPS ASSEMBLED VIA MOTOR FREIGHT

## 3-IN-1 HAND TRUCKS

Transform easily from hand truck to incline to platform truck.

- 28 x 8" folding nose extension restrains loads in incline and platform positions.
- Large 18 x 7½" magnesium nose plate.
- Anti-slip curved handle.
- Retractable swivel casters.

45° Incline



Platform



ALUMINUM

MODEL NO.	LOAD CAP. (LBS.)	HANDLE TYPE	WHEEL TYPE	HT.	WT. (LBS.)	PRICE EACH	
						1	3+
H-4124	500/750	Continuous	10" Rubber	52"	40	\$320	\$300
H-2086			10" Pneumatic				

SHIPS UNASSEMBLED VIA UPS

# ULINE STEEL HAND TRUCKS



H-1541



H-1786



H-2400

Extra Large Nose Plate  
w/ Pneumatic Wheels



H-966



## STANDARD

Built-to-last, heavy-duty workhorses.

- 14 x 8" beveled nose plate.
- Continuous Handle – Excellent one or two-handed load control.
- Loop Handle – Control tall loads with one hand.
- Extra Large Nose Plates – 16 x 13" (H-2055, H-2400) and 20 x 8" (H-4794) for oversized loads.

MODEL NO.	HANDLE TYPE	WHEEL TYPE	LOAD CAP. (LBS.)	HEIGHT	WT. (LBS.)	PRICE EACH	
						1	3+
H-1541	Continuous Loop	10" Solid Rubber	800	46"	35	\$145	\$135
■H-1786							
■H-2055	Loop with XL Nose Plate	10" Solid Rubber	800	51"	46	170	160
H-4794							
■H-2400		10" Pneumatic	650	42	180	170	

■ SHIPS ASSEMBLED VIA MOTOR FREIGHT

## CONVERTIBLE

2-in-1 platform or hand truck.

- Converts in seconds. Just press and release bar.
- H-966 capacity: 700 lbs. hand truck; 1,000 lbs. platform.
- H-2401 capacity: 650 lbs. hand truck; 950 lbs. platform.
- 14 x 7½" nose plate. 10" wheels.
- Platform size: 14 x 43¼" (W x L).

MODEL NO.	HANDLE TYPE	WHEEL TYPE	LOAD CAP. (LBS.)	HEIGHT	WT. (LBS.)	PRICE EACH	
						1	3+
H-966	Continuous	10" Solid Rubber	700/1,000	53"	53	\$245	\$225
H-2401	Continuous	10" Pneumatic	650/950	53"	50	260	240

SHIPS ASSEMBLED VIA MOTOR FREIGHT

## GAS CYLINDER HAND TRUCKS

Safely move pressurized tanks throughout work areas.

- Heavy-gauge steel. Continuous handle.
- Chain secures tanks up to 12" in diameter.
- Single Cylinder – 14 x 7" trapezoid nose plate. 3 curved crossbars for stability.
- Dual Cylinder – 24 x 12" nose plate. 1" rear lip for stability. Large tool tray.

MODEL NO.	DESCRIPTION	WHEEL TYPE	LOAD CAP. (LBS.)	HEIGHT	WT. (LBS.)	PRICE EACH	
						1	3+
H-3192	Single	10" Solid Rubber	500	48"	31	\$155	\$145
■H-3193	Dual			37"			

■ SHIPS ASSEMBLED VIA MOTOR FREIGHT



H-3192



H-3193

## WALK RAMPS



MAGLINER®

Load and unload your truck or van when no dock is available.

- Slip-resistant surface. 4¼" side rails.
- Safety chains secure ramp to truck.
- 8" overlapping apron smooths truck-to-ramp transition.
- Aluminum construction.

H-6716 – 39" wide for appliance hand trucks.

SHIPS VIA MOTOR FREIGHT

MODEL NO.	SIZE L x W	USABLE WIDTH	HEIGHT MAX.	LOAD CAP. (LBS.)	WT. (LBS.)	PRICE EACH	
						1	2+
H-1438	8' x 29"	26"	31"	2,500	78	\$665	\$635
H-6716	14' x 39"	37"	52"	1,600	151	1,125	1,075

## HAND TRUCK USE

# MAGLINER® ALUMINUM HAND TRUCKS

## STANDARD



H-1054

H-2661

Lightweight, high-strength aluminum construction.

- Rubber wheels roll easily over all types of surfaces.
- Aluminum nose plate. 48" high with continuous handle.
- H-2661 with stair climber. Move items up and down steps and curbs.
- **Nose Extension** – Provides stability for larger loads. Folds up against frame when not in use.
- **Frame Extension** – Increases height to 60" for taller loads.



H-1208

### STANDARD

SHIPS UNASSEMBLED VIA UPS

MODEL NO.	LOAD CAPACITY (LBS.)	WHEEL TYPE	NOSE PLATE	WT. (LBS.)	PRICE EACH	
					1	3+
H-1054	500	8" Solid Rubber	14 x 7½"	20	\$195	\$185
H-2661		8" Solid Rubber		23	220	210
H-3376		10" Pneumatic		29	220	210

### ACCESSORIES

MODEL NO.	LOAD CAPACITY (LBS.)	DESCRIPTION	WT. (LBS.)	PRICE EACH	PRICE EACH
				1	3+
H-1208	300	30" Nose Extension	4	\$60	\$55
H-3377	N/A	60" Frame Extension	2	24	23

## CONVERTIBLE

Versatile. Simple quick release converts hand truck to platform truck.

- Capacity: 500 lbs. hand truck; 1,000 lbs. platform.
- 5" retractable polyurethane casters.
- **Junior** – 51" high. Dual handle. Easy to maneuver.
- **Senior** – 61" high. Curved handle.
- Wheels available in both solid rubber and pneumatic.
- **Platform Deck** snaps on for small and odd-shaped items. Embossed surface.



H-1382 with Platform Deck Option

### CONVERTIBLE JR.

SHIPS UNASSEMBLED VIA UPS

MODEL NO.	LOAD CAPACITY (LBS.)	WHEEL TYPE	NOSE PLATE	WT. (LBS.)	PRICE EACH	
					1	3+
H-4937	500/1,000	10" Solid Rubber	18 x 7½"	45	\$385	\$370
H-4938		10" Pneumatic		44	395	380
H-4939		Platform Deck	43 x 12"	6	110	105

### CONVERTIBLE SR.

MODEL NO.	LOAD CAPACITY (LBS.)	WHEEL TYPE	NOSE PLATE	WT. (LBS.)	PRICE EACH	
					1	3+
H-1006	500/1,000	10" Solid Rubber	18 x 7½"	51	\$405	\$390
H-1382		10" Pneumatic		48	415	400
H-3375		Platform Deck	56 x 12"	7	115	110



H-1006

H-4938

## MAGLINER® HAND TRUCK WHEELS

Keep your hand trucks rolling smoothly with replacement wheels.

- H-3378 – Durable and lightweight. Molded to aluminum hub.
- H-3379 – Puncture resistant and easy to roll.
- H-3380 – Air-filled to provide a gentle, cushioned ride.



H-3378



H-3379



H-3380

MODEL NO.	WHEEL TYPE	CAPACITY (LBS.)	WHEEL DIAM. x W	FITS AXLE DIAM.	HUB MATERIAL	HUB WIDTH	HUB TYPE	WT. (LBS.)	PRICE EACH		FITS MAGLINER® TRUCK
									1	4+	
H-3378	Solid Rubber	250	8 x 1½"	5/8"	Aluminum	1¼"	Off-Set	3	\$32	\$30	H-1054
H-3379	Solid Rubber	500	10 x 2½"		Plastic	2¼"		6	33	31	H-1006
H-3380	Pneumatic	500	10 x 3½"		Steel	2¼"		5	39	37	H-1382



# ULINE ALUMINUM HAND TRUCKS

## STANDARD

Lightweight, rugged, easy-to-handle aluminum.

- Quality, value and years of service. • Beveled nose plate.
- **Standard** – 50" high. Curved handle with anti-slip plastic grip.
- **Loop** – 52" high. Maneuver easily with one hand.
- **Stair Climber** – Transport heavy loads up and down steps and curbs.

STANDARD				SHIPS UNASSEMBLED VIA UPS		
MODEL NO.	LOAD CAPACITY (LBS.)	WHEEL TYPE	NOSE PLATE	WT. (LBS.)	PRICE EACH	
					1	3+
H-1361	500	10" Solid Rubber	14 x 7½"	25	\$150	\$140
H-1362		10" Pneumatic		24		

## LOOP HANDLE

H-4884	500	10" Solid Rubber	14 x 7½"	26	\$165	\$155
H-4885		10" Pneumatic		21		
H-3199	500	10" Solid Rubber	16 x 13"	29	170	160
H-3200		10" Pneumatic		28		
H-4889	250	Stair Climber Accessory		3	32	30



## CONVERTIBLE

Converts from hand truck to platform in seconds.

- Capacity: 500 lbs. hand truck; 800 lbs. platform.
- 5" retractable polyurethane casters.
- **Junior** – 51" high. Dual handle. Easy to maneuver.
- **Senior** – 61" high. Anti-slip curved handle.
- **Platform Deck** snaps on for small and odd-shaped items. Embossed surface.



CONVERTIBLE JR.				SHIPS UNASSEMBLED VIA UPS		
MODEL NO.	LOAD CAPACITY (LBS.)	WHEEL TYPE	NOSE PLATE	WT. (LBS.)	PRICE EACH	
					1	3+
H-1479	500/800	10" Solid Rubber	18 x 7½"	46	\$255	\$245
H-1480		10" Pneumatic		41		
H-3216		Platform Deck	43 x 12"	6	70	65

## CONVERTIBLE SR.

H-1363	500/800	10" Solid Rubber	18 x 7½"	49	\$265	\$255
H-1364		10" Pneumatic		44		
H-3217		Platform Deck	56 x 12"	7	85	80



## ULINE HAND TRUCK WHEELS

Keep your hand trucks rolling smoothly with replacement wheels.

- **H-3358** – Can't be punctured. Never go flat.
- **H-3359** – Protect loads over the roughest surfaces. • **H-5454** – Flat Free Pneumatic. Non-marking wheels.



MODEL NO.	WHEEL TYPE	CAPACITY (LBS.)	WHEEL DIAM. x W	FITS AXLE DIAM.	HUB MATERIAL	HUB WIDTH	HUB TYPE	WT. (LBS.)	PRICE EACH		FITS ULINE TRUCK
									1	4+	
H-3358	Solid Rubber	400	10 x 2½"	5/8"	Plastic	2¼"	Off-Set	7	\$22	\$21	ALL
H-3359	Pneumatic	350	10 x 3½"		Steel			4	27	25	
H-5454	Flat Free	300	10 x 3½"		Steel			4	33	31	

# CHROME WIRE SHELVING

Continued from page 453.

## 4 SHELF STARTER UNITS

72" HEIGHT ■ SHIPS UNASSEMBLED VIA MOTOR FREIGHT					
MODEL NO.	DIMENSIONS W x D x H	SHELF CAP. (LBS.)	PRICE EACH		WT. (LBS.)
			1	3+	
H-2935-72	24 x 12 x 72"	350	\$156	\$145	39
H-2936-72	36 x 12 x 72"	350	169	158	42
H-2937-72	48 x 12 x 72"	350	184	171	47
H-2938-72	24 x 18 x 72"	800	169	158	47
H-2939-72	30 x 18 x 72"	800	173	162	50
H-2940-72	36 x 18 x 72"	800	182	169	55
H-2941-72	48 x 18 x 72"	800	\$193 ea. any qty.		66
H-2942-72	60 x 18 x 72"	650	242	230	84
H-2943-72	72 x 18 x 72"	650	278	267	96
H-2944-72	24 x 24 x 72"	800	182	169	60
H-2945-72	36 x 24 x 72"	800	193	182	68
H-2946-72	48 x 24 x 72"	800	\$230 ea. any qty.		80
H-2947-72	60 x 24 x 72"	650	278	267	100
■H-2948-72	72 x 24 x 72"	650	339	327	124
H-2949-72	48 x 36 x 72"	800	396	384	116
■H-2950-72	60 x 36 x 72"	650	420	407	142
■H-2951-72	72 x 36 x 72"	650	442	431	172
H-1205WH	Set of 4 Lockable Casters		75	72	12

## 4 SHELF ADD-ON UNITS

72" HEIGHT ■ SHIPS UNASSEMBLED VIA MOTOR FREIGHT					
MODEL NO.	DIMENSIONS W x D x H	PRICE EACH		WT. (LBS.)	
		1	3+		
H-2935-72A	24 x 12 x 72"	\$131	\$120	28	
H-2936-72A	36 x 12 x 72"	145	132	35	
H-2937-72A	48 x 12 x 72"	159	147	46	
H-2938-72A	24 x 18 x 72"	145	132	40	
H-2939-72A	30 x 18 x 72"	151	140	42	
H-2940-72A	36 x 18 x 72"	156	145	48	
H-2941-72A	48 x 18 x 72"	182	169	59	
H-2942-72A	60 x 18 x 72"	217	205	77	
H-2943-72A	72 x 18 x 72"	254	242	89	
H-2944-72A	24 x 24 x 72"	156	145	53	
H-2945-72A	36 x 24 x 72"	169	158	61	
H-2946-72A	48 x 24 x 72"	217	205	73	
H-2947-72A	60 x 24 x 72"	254	242	93	
■H-2948-72A	72 x 24 x 72"	314	302	117	
H-2949-72A	48 x 36 x 72"	373	360	108	
■H-2950-72A	60 x 36 x 72"	396	384	135	
■H-2951-72A	72 x 36 x 72"	420	407	165	

86" HEIGHT ■ SHIPS UNASSEMBLED VIA MOTOR FREIGHT					
MODEL NO.	DIMENSIONS W x D x H	SHELF CAP. (LBS.)	PRICE EACH		WT. (LBS.)
			1	3+	
H-2938-86	24 x 18 x 86"	800	\$182	\$169	49
H-2939-86	30 x 18 x 86"	800	186	173	52
H-2940-86	36 x 18 x 86"	800	193	182	57
H-2941-86	48 x 18 x 86"	800	217	205	68
H-2942-86	60 x 18 x 86"	650	254	242	86
H-2943-86	72 x 18 x 86"	650	290	279	98
H-2944-86	24 x 24 x 86"	800	193	182	62
H-2945-86	36 x 24 x 86"	800	205	194	70
H-2946-86	48 x 24 x 86"	800	254	242	82
H-2947-86	60 x 24 x 86"	650	290	279	102
■H-2948-86	72 x 24 x 86"	650	351	339	126
H-6760-86	48 x 30 x 86"	800	338	326	103
H-6761-86	60 x 30 x 86"	650	373	360	125
■H-6762-86	72 x 30 x 86"	650	414	401	150
H-2949-86	48 x 36 x 86"	800	407	396	118
■H-2950-86	60 x 36 x 86"	650	431	420	144
■H-2951-86	72 x 36 x 86"	650	455	442	174
H-1205WH	Set of 4 Lockable Casters		75	72	12

86" HEIGHT ■ SHIPS UNASSEMBLED VIA MOTOR FREIGHT					
MODEL NO.	DIMENSIONS W x D x H	PRICE EACH		WT. (LBS.)	
		1	3+		
H-2938-86A	24 x 18 x 86"	\$156	\$145	41	
H-2939-86A	30 x 18 x 86"	162	151	43	
H-2940-86A	36 x 18 x 86"	169	158	49	
H-2941-86A	48 x 18 x 86"	193	182	60	
H-2942-86A	60 x 18 x 86"	230	218	78	
H-2943-86A	72 x 18 x 86"	267	255	90	
H-2944-86A	24 x 24 x 86"	169	158	54	
H-2945-86A	36 x 24 x 86"	182	169	62	
H-2946-86A	48 x 24 x 86"	230	218	74	
H-2947-86A	60 x 24 x 86"	267	255	94	
■H-2948-86A	72 x 24 x 86"	327	315	118	
H-6760-86A	48 x 30 x 86"	314	302	96	
H-6761-86A	60 x 30 x 86"	350	338	118	
■H-6762-86A	72 x 30 x 86"	391	379	143	
H-2949-86A	48 x 36 x 86"	384	373	109	
■H-2950-86A	60 x 36 x 86"	407	396	136	
■H-2951-86A	72 x 36 x 86"	431	420	166	

96" HEIGHT ■ SHIPS UNASSEMBLED VIA MOTOR FREIGHT					
MODEL NO.	DIMENSIONS W x D x H	SHELF CAP. (LBS.)	PRICE EACH		WT. (LBS.)
			1	3+	
■H-2938-96	24 x 18 x 96"	800	\$193	\$182	51
■H-2939-96	30 x 18 x 96"	800	197	186	54
■H-2940-96	36 x 18 x 96"	800	204	193	59
■H-2941-96	48 x 18 x 96"	800	229	217	70
■H-2942-96	60 x 18 x 96"	650	266	254	88
■H-2943-96	72 x 18 x 96"	650	302	290	100
■H-2944-96	24 x 24 x 96"	800	204	193	64
■H-2945-96	36 x 24 x 96"	800	217	205	72
■H-2946-96	48 x 24 x 96"	800	266	254	84
■H-2947-96	60 x 24 x 96"	650	302	290	104
■H-2948-96	72 x 24 x 96"	650	362	351	128
■H-6760-96	48 x 30 x 96"	800	350	338	105
■H-6761-96	60 x 30 x 96"	650	384	373	127
■H-6762-96	72 x 30 x 96"	650	425	414	152
■H-2949-96	48 x 36 x 96"	800	420	407	120
■H-2950-96	60 x 36 x 96"	650	442	431	146
■H-2951-96	72 x 36 x 96"	650	466	455	176
H-1205WH	Set of 4 Lockable Casters		75	72	12

96" HEIGHT ■ SHIPS UNASSEMBLED VIA MOTOR FREIGHT					
MODEL NO.	DIMENSIONS W x D x H	PRICE EACH		WT. (LBS.)	
		1	3+		
■H-2938-96A	24 x 18 x 96"	\$168	\$156	42	
■H-2939-96A	30 x 18 x 96"	173	162	44	
■H-2940-96A	36 x 18 x 96"	182	169	50	
■H-2941-96A	48 x 18 x 96"	204	193	61	
■H-2942-96A	60 x 18 x 96"	242	230	79	
■H-2943-96A	72 x 18 x 96"	278	267	91	
■H-2944-96A	24 x 24 x 96"	182	169	55	
■H-2945-96A	36 x 24 x 96"	193	182	63	
■H-2946-96A	48 x 24 x 96"	242	230	75	
■H-2947-96A	60 x 24 x 96"	278	267	95	
■H-2948-96A	72 x 24 x 96"	339	327	119	
■H-6760-96A	48 x 30 x 96"	326	314	98	
■H-6761-96A	60 x 30 x 96"	360	350	120	
■H-6762-96A	72 x 30 x 96"	401	391	145	
■H-2949-96A	48 x 36 x 96"	396	384	110	
■H-2950-96A	60 x 36 x 96"	420	407	137	
■H-2951-96A	72 x 36 x 96"	442	431	167	

# CHROME WIRE SHELVING

## Starter Units

- Shelves adjust in 1" increments. • NSF certified.
- Assemble in minutes. No tools required.
- Reduce dust and dirt accumulation.
- Optional 5" polyurethane swivel stem casters add 6" to height.

## Add-On Units

- Includes 4 shelves, 2 posts and 8 S-hook connectors.
- Extend shelving at a 90° angle, end-to-end or back-to-back.



LOCKABLE CASTERS



S-HOOKS

See pages 456-457 for additional accessories.



## 4 SHELF STARTER UNITS

### 54" HEIGHT

■ SHIPS UNASSEMBLED VIA MOTOR FREIGHT

MODEL NO.	DIMENSIONS W x D x H	SHELF CAP. (LBS.)	PRICE EACH		WT. (LBS.)
			1	3+	
H-2935-54	24 x 12 x 54"	350	\$131	\$120	35
H-2936-54	36 x 12 x 54"	350	145	132	38
H-2937-54	48 x 12 x 54"	350	159	147	43
H-2938-54	24 x 18 x 54"	800	145	132	43
H-2939-54	30 x 18 x 54"	800	151	140	46
H-2940-54	36 x 18 x 54"	800	156	145	51
H-2941-54	48 x 18 x 54"	800	182	169	62
H-2942-54	60 x 18 x 54"	650	217	205	80
H-2943-54	72 x 18 x 54"	650	254	242	92
H-2944-54	24 x 24 x 54"	800	156	145	56
H-2945-54	36 x 24 x 54"	800	169	158	64
H-2946-54	48 x 24 x 54"	800	217	205	76
H-2947-54	60 x 24 x 54"	650	254	242	96
■H-2948-54	72 x 24 x 54"	650	314	302	120
H-2949-54	48 x 36 x 54"	800	373	360	112
■H-2950-54	60 x 36 x 54"	650	396	384	138
■H-2951-54	72 x 36 x 54"	650	420	407	168
H-1205WH	Set of 4 Lockable Casters		75	72	12

### 63" HEIGHT

■ SHIPS UNASSEMBLED VIA MOTOR FREIGHT

MODEL NO.	DIMENSIONS W x D x H	SHELF CAP. (LBS.)	PRICE EACH		WT. (LBS.)
			1	3+	
H-2935-63	24 x 12 x 63"	350	\$145	\$132	37
H-2936-63	36 x 12 x 63"	350	156	145	40
H-2937-63	48 x 12 x 63"	350	171	160	45
H-2938-63	24 x 18 x 63"	800	156	145	45
H-2939-63	30 x 18 x 63"	800	164	152	48
H-2940-63	36 x 18 x 63"	800	169	158	53
H-2941-63	48 x 18 x 63"	800	193	182	64
H-2942-63	60 x 18 x 63"	650	230	218	82
H-2943-63	72 x 18 x 63"	650	267	255	94
H-2944-63	24 x 24 x 63"	800	169	158	58
H-2945-63	36 x 24 x 63"	800	182	169	66
H-2946-63	48 x 24 x 63"	800	230	218	78
H-2947-63	60 x 24 x 63"	650	267	255	98
■H-2948-63	72 x 24 x 63"	650	327	315	122
H-2949-63	48 x 36 x 63"	800	384	373	114
■H-2950-63	60 x 36 x 63"	650	407	396	140
■H-2951-63	72 x 36 x 63"	650	431	420	170
H-1205WH	Set of 4 Lockable Casters		75	72	12

## 4 SHELF ADD-ON UNITS

### 54" HEIGHT

■ SHIPS UNASSEMBLED VIA MOTOR FREIGHT

MODEL NO.	DIMENSIONS W x D x H	PRICE EACH		WT. (LBS.)
		1	3+	
H-2935-54A	24 x 12 x 54"	\$109	\$97	26
H-2936-54A	36 x 12 x 54"	120	109	33
H-2937-54A	48 x 12 x 54"	133	123	44
H-2938-54A	24 x 18 x 54"	120	109	38
H-2939-54A	30 x 18 x 54"	126	114	40
H-2940-54A	36 x 18 x 54"	131	120	46
H-2941-54A	48 x 18 x 54"	156	145	57
H-2942-54A	60 x 18 x 54"	193	182	75
H-2943-54A	72 x 18 x 54"	230	218	87
H-2944-54A	24 x 24 x 54"	131	120	51
H-2945-54A	36 x 24 x 54"	145	132	59
H-2946-54A	48 x 24 x 54"	193	182	71
H-2947-54A	60 x 24 x 54"	230	218	91
■H-2948-54A	72 x 24 x 54"	290	279	115
H-2949-54A	48 x 36 x 54"	350	338	106
■H-2950-54A	60 x 36 x 54"	373	360	133
■H-2951-54A	72 x 36 x 54"	396	384	163

### 63" HEIGHT

■ SHIPS UNASSEMBLED VIA MOTOR FREIGHT

MODEL NO.	DIMENSIONS W x D x H	PRICE EACH		WT. (LBS.)
		1	3+	
H-2935-63A	24 x 12 x 63"	\$120	\$109	27
H-2936-63A	36 x 12 x 63"	131	120	34
H-2937-63A	48 x 12 x 63"	147	135	45
H-2938-63A	24 x 18 x 63"	131	120	39
H-2939-63A	30 x 18 x 63"	140	127	41
H-2940-63A	36 x 18 x 63"	145	132	47
H-2941-63A	48 x 18 x 63"	169	158	58
H-2942-63A	60 x 18 x 63"	205	194	76
H-2943-63A	72 x 18 x 63"	242	230	88
H-2944-63A	24 x 24 x 63"	145	132	52
H-2945-63A	36 x 24 x 63"	156	145	60
H-2946-63A	48 x 24 x 63"	205	194	72
H-2947-63A	60 x 24 x 63"	242	230	92
■H-2948-63A	72 x 24 x 63"	302	290	116
H-2949-63A	48 x 36 x 63"	360	350	107
■H-2950-63A	60 x 36 x 63"	384	373	134
■H-2951-63A	72 x 36 x 63"	407	396	164



# BLACK WIRE SHELVING

Continued from page 455.

## 4 SHELF STARTER UNITS

72" HEIGHT

■ SHIPS UNASSEMBLED VIA MOTOR FREIGHT

MODEL NO.	DIMENSIONS W x D x H	SHELF CAP. (LBS.)	PRICE EACH		WT. (LBS.)
			1	3+	
H-2420-72	24 x 12 x 72"	350	\$145	\$132	39
H-2421-72	36 x 12 x 72"	350	156	145	49
H-2422-72	48 x 12 x 72"	350	171	160	58
H-2423-72	24 x 18 x 72"	800	156	145	45
H-1748-72	36 x 18 x 72"	800	169	158	55
H-1749-72	48 x 18 x 72"	800	193	182	66
H-2424-72	60 x 18 x 72"	650	230	218	84
H-2425-72	72 x 18 x 72"	650	267	255	94
H-2132-72	36 x 24 x 72"	800	182	169	63
H-1750-72	48 x 24 x 72"	800	230	218	80
H-1751-72	60 x 24 x 72"	650	267	255	100
■H-1752-72	72 x 24 x 72"	650	327	315	122
H-3766-72	48 x 36 x 72"	800	384	373	119
■H-2427-72	60 x 36 x 72"	650	407	396	143
■H-2428-72	72 x 36 x 72"	650	431	420	168
H-1205WH	Set of 4 Lockable Casters		75	72	12

## 4 SHELF ADD-ON UNITS

72" HEIGHT

■ SHIPS UNASSEMBLED VIA MOTOR FREIGHT

MODEL NO.	DIMENSIONS W x D x H	PRICE EACH		WT. (LBS.)
		1	3+	
H-2420-72A	24 x 12 x 72"	\$120	\$109	32
H-2421-72A	36 x 12 x 72"	131	120	42
H-2422-72A	48 x 12 x 72"	147	135	50
H-2423-72A	24 x 18 x 72"	131	120	38
H-1748-72A	36 x 18 x 72"	145	132	48
H-1749-72A	48 x 18 x 72"	169	158	59
H-2424-72A	60 x 18 x 72"	205	194	77
H-2425-72A	72 x 18 x 72"	242	230	87
H-2132-72A	36 x 24 x 72"	156	145	56
H-1750-72A	48 x 24 x 72"	205	194	73
H-1751-72A	60 x 24 x 72"	242	230	93
■H-1752-72A	72 x 24 x 72"	302	290	115
H-3766-72A	48 x 36 x 72"	360	350	112
■H-2427-72A	60 x 36 x 72"	384	373	136
■H-2428-72A	72 x 36 x 72"	407	396	161

86" HEIGHT

■ SHIPS UNASSEMBLED VIA MOTOR FREIGHT

H-2423-86	24 x 18 x 86"	800	\$169	\$158	47
H-1748-86	36 x 18 x 86"	800	182	169	57
H-1749-86	48 x 18 x 86"	800	205	194	68
H-2424-86	60 x 18 x 86"	650	242	230	86
H-2425-86	72 x 18 x 86"	650	278	267	96
H-2132-86	36 x 24 x 86"	800	193	182	66
H-1750-86	48 x 24 x 86"	800	242	230	82
H-1751-86	60 x 24 x 86"	650	278	267	102
■H-1752-86	72 x 24 x 86"	650	339	327	124
H-6748-86	48 x 30 x 86"	800	326	314	103
H-6749-86	60 x 30 x 86"	650	360	350	125
■H-6750-86	72 x 30 x 86"	650	401	391	150
H-3766-86	48 x 36 x 86"	800	396	384	121
■H-2427-86	60 x 36 x 86"	650	420	407	146
■H-2428-86	72 x 36 x 86"	650	442	431	170
H-1205WH	Set of 4 Lockable Casters		75	72	12

86" HEIGHT

■ SHIPS UNASSEMBLED VIA MOTOR FREIGHT

H-2423-86A	24 x 18 x 86"	\$145	\$132	39
H-1748-86A	36 x 18 x 86"	156	145	49
H-1749-86A	48 x 18 x 86"	182	169	60
H-2424-86A	60 x 18 x 86"	217	205	78
H-2425-86A	72 x 18 x 86"	254	242	88
H-2132-86A	36 x 24 x 86"	169	158	57
H-1750-86A	48 x 24 x 86"	217	205	74
H-1751-86A	60 x 24 x 86"	254	242	94
■H-1752-86A	72 x 24 x 86"	314	302	116
H-6748-86A	48 x 30 x 86"	302	290	96
H-6749-86A	60 x 30 x 86"	338	326	118
■H-6750-86A	72 x 30 x 86"	379	366	143
H-3766-86A	48 x 36 x 86"	373	360	113
■H-2427-86A	60 x 36 x 86"	396	384	138
■H-2428-86A	72 x 36 x 86"	420	407	162

96" HEIGHT

■ SHIPS UNASSEMBLED VIA MOTOR FREIGHT

■H-2423-96	24 x 18 x 96"	800	\$182	\$169	49
■H-1748-96	36 x 18 x 96"	800	193	182	59
■H-1749-96	48 x 18 x 96"	800	217	205	70
■H-2424-96	60 x 18 x 96"	650	254	242	88
■H-2425-96	72 x 18 x 96"	650	290	279	98
■H-2132-96	36 x 24 x 96"	800	205	194	68
■H-1750-96	48 x 24 x 96"	800	254	242	84
■H-1751-96	60 x 24 x 96"	650	290	279	104
■H-1752-96	72 x 24 x 96"	650	351	339	126
■H-6748-96	48 x 30 x 96"	800	338	326	105
■H-6749-96	60 x 30 x 96"	650	373	360	127
■H-6750-96	72 x 30 x 96"	650	414	401	152
■H-3766-96	48 x 36 x 96"	800	407	396	123
■H-2427-96	60 x 36 x 96"	650	431	420	148
■H-2428-96	72 x 36 x 96"	650	455	442	172
H-1205WH	Set of 4 Lockable Casters		75	72	12

96" HEIGHT

■ SHIPS UNASSEMBLED VIA MOTOR FREIGHT

■H-2423-96A	24 x 18 x 96"	\$156	\$145	40
■H-1748-96A	36 x 18 x 96"	169	158	50
■H-1749-96A	48 x 18 x 96"	193	182	61
■H-2424-96A	60 x 18 x 96"	230	218	79
■H-2425-96A	72 x 18 x 96"	267	255	89
■H-2132-96A	36 x 24 x 96"	182	169	59
■H-1750-96A	48 x 24 x 96"	230	218	75
■H-1751-96A	60 x 24 x 96"	267	255	95
■H-1752-96A	72 x 24 x 96"	327	315	117
■H-6748-96A	48 x 30 x 96"	314	302	98
■H-6749-96A	60 x 30 x 96"	350	338	120
■H-6750-96A	72 x 30 x 96"	391	379	145
■H-3766-96A	48 x 36 x 96"	384	373	114
■H-2427-96A	60 x 36 x 96"	407	396	139
■H-2428-96A	72 x 36 x 96"	431	420	163

# BLACK WIRE SHELVING

Decorative heavy-duty shelving looks good in offices, stores and warehouses.

- Easy assembly – No tools needed.
- Shelves adjust in 1" increments. • NSF certified.
- Open wire maximizes airflow, reduces dirt and dust buildup.
- Black powder coating resists corrosion, lasts for years.
- Optional 5" polyurethane swivel stem casters add 6" to height.



LOCKABLE CASTERS



S-HOOKS

**Add-On Units** – Includes 4 shelves, 2 posts and 8 S-hook connectors.

- Extend shelving at a 90° angle, end-to-end or back-to-back.



## 4 SHELF STARTER UNITS

54" HEIGHT

■ SHIPS UNASSEMBLED VIA MOTOR FREIGHT

MODEL NO.	DIMENSIONS W x D x H	SHELF CAP. (LBS.)	PRICE EACH		WT. (LBS.)
			1	3+	
H-2420-54	24 x 12 x 54"	350	\$120	\$109	35
H-2421-54	36 x 12 x 54"	350	131	120	45
H-2422-54	48 x 12 x 54"	350	147	135	53
H-2423-54	24 x 18 x 54"	800	131	120	41
H-1748-54	36 x 18 x 54"	800	145	132	51
H-1749-54	48 x 18 x 54"	800	169	158	62
H-2424-54	60 x 18 x 54"	650	205	194	80
H-2425-54	72 x 18 x 54"	650	242	230	90
H-2132-54	36 x 24 x 54"	800	156	145	59
H-1750-54	48 x 24 x 54"	800	205	194	76
H-1751-54	60 x 24 x 54"	650	242	230	96
■H-1752-54	72 x 24 x 54"	650	302	290	118
H-3766-54	48 x 36 x 54"	800	360	350	115
■H-2427-54	60 x 36 x 54"	650	384	373	139
■H-2428-54	72 x 36 x 54"	650	407	396	164
H-1205WH	Set of 4 Lockable Casters		75	72	12

## 4 SHELF ADD-ON UNITS

54" HEIGHT

■ SHIPS UNASSEMBLED VIA MOTOR FREIGHT

MODEL NO.	DIMENSIONS W x D x H	PRICE EACH		WT. (LBS.)
		1	3+	
H-2420-54A	24 x 12 x 54"	\$96	\$84	30
H-2421-54A	36 x 12 x 54"	109	97	40
H-2422-54A	48 x 12 x 54"	123	111	48
H-2423-54A	24 x 18 x 54"	109	97	36
H-1748-54A	36 x 18 x 54"	120	109	46
H-1749-54A	48 x 18 x 54"	145	132	57
H-2424-54A	60 x 18 x 54"	182	169	75
H-2425-54A	72 x 18 x 54"	217	205	85
H-2132-54A	36 x 24 x 54"	131	120	54
H-1750-54A	48 x 24 x 54"	182	169	71
H-1751-54A	60 x 24 x 54"	217	205	91
■H-1752-54A	72 x 24 x 54"	278	267	113
H-3766-54A	48 x 36 x 54"	338	326	110
■H-2427-54A	60 x 36 x 54"	360	350	134
■H-2428-54A	72 x 36 x 54"	384	373	159

63" HEIGHT

■ SHIPS UNASSEMBLED VIA MOTOR FREIGHT

MODEL NO.	DIMENSIONS W x D x H	SHELF CAP. (LBS.)	PRICE EACH		WT. (LBS.)
			1	3+	
H-2420-63	24 x 12 x 63"	350	\$131	\$120	37
H-2421-63	36 x 12 x 63"	350	145	132	47
H-2422-63	48 x 12 x 63"	350	159	147	55
H-2423-63	24 x 18 x 63"	800	145	132	42
H-1748-63	36 x 18 x 63"	800	156	145	53
H-1749-63	48 x 18 x 63"	800	182	169	64
H-2424-63	60 x 18 x 63"	650	217	205	81
H-2425-63	72 x 18 x 63"	650	254	242	92
H-2132-63	36 x 24 x 63"	800	169	158	61
H-1750-63	48 x 24 x 63"	800	217	205	78
H-1751-63	60 x 24 x 63"	650	254	242	98
■H-1752-63	72 x 24 x 63"	650	314	302	120
H-3766-63	48 x 36 x 63"	800	373	360	117
■H-2427-63	60 x 36 x 63"	650	396	384	141
■H-2428-63	72 x 36 x 63"	650	420	407	166
H-1205WH	Set of 4 Lockable Casters		75	72	12

63" HEIGHT

■ SHIPS UNASSEMBLED VIA MOTOR FREIGHT

MODEL NO.	DIMENSIONS W x D x H	PRICE EACH		WT. (LBS.)
		1	3+	
H-2420-63A	24 x 12 x 63"	\$109	\$97	31
H-2421-63A	36 x 12 x 63"	120	109	40
H-2422-63A	48 x 12 x 63"	133	123	49
H-2423-63A	24 x 18 x 63"	120	109	36
H-1748-63A	36 x 18 x 63"	131	120	47
H-1749-63A	48 x 18 x 63"	156	145	58
H-2424-63A	60 x 18 x 63"	193	182	75
H-2425-63A	72 x 18 x 63"	230	218	86
H-2132-63A	36 x 24 x 63"	145	132	55
H-1750-63A	48 x 24 x 63"	193	182	72
H-1751-63A	60 x 24 x 63"	230	218	92
■H-1752-63A	72 x 24 x 63"	290	279	114
H-3766-63A	48 x 36 x 63"	350	338	111
■H-2427-63A	60 x 36 x 63"	373	360	135
■H-2428-63A	72 x 36 x 63"	396	384	160

# SHELF LINERS

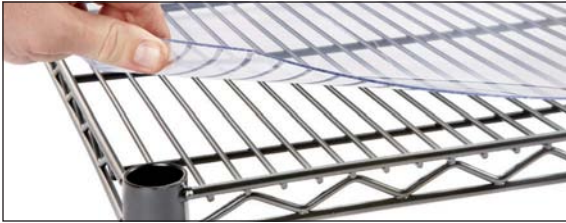

Keep your smallest items from falling through.

- Durable 1/16" liners provide a solid surface.

**Clear** – Allows you to notice items on all shelves. Acrylic.

**Black** – Stylish matte surface makes your product pop. Polypropylene.

\* SPECIFY COLOR: Clear or Black

Sold in multiples of 4

MODEL NO.	SIZE W x D	QTY./ CTN.	LBS./ CTN.	PRICE PER LINER		
				4	12+	
H-2430	24 x 12"	4	3	\$11	\$9	
H-2431	36 x 12"		4	14	13	
H-2432	48 x 12"		5	17	16	
H-2433	24 x 18"	4	4	17	16	
H-4840	30 x 18"		5	19	18	
H-2434*	36 x 18"		6	21	20	
H-2435*	48 x 18"		8	22	21	
H-2436	60 x 18"		10	24	22	
H-2437	72 x 18"		13	26	25	
H-2438	24 x 24"		4	5	24	22

\* SPECIFY COLOR: Clear or Black

Sold in multiples of 4

MODEL NO.	SIZE W x D	QTY./ CTN.	LBS./ CTN.	PRICE PER LINER	
				4	12+
H-2439*	36 x 24"	4	8	\$27	\$26
H-2440*	48 x 24"		11	29	28
H-2441*	60 x 24"		13	37	35
■H-2442*	72 x 24"		17	39	37
H-6725	48 x 30"		14	44	42
H-6726	60 x 30"	4	17	50	48
■H-6727	72 x 30"		21	55	53
H-4264	48 x 36"	4	16	58	56
■H-2443	60 x 36"		21	65	63
■H-2444	72 x 36"		25	69	67

■ SHIPS VIA MOTOR FREIGHT

# SNAP-ON LABEL HOLDERS



Plastic label holders. Paper inserts included.

**Standard** – Sits flat against wire shelving.



**Angled** – Adjustable at 3 angles: 30°, 60° or 90° for easier viewing on high or low shelves.

**STANDARD**

Vertical Label Holder, see uline.com

MODEL NO.	SIZE L x H	QTY./ PACK	LBS./ PACK	PRICE PER PACK	
				1	3+
S-14461	3 x 1 1/4"	25	1	\$21	\$20
S-14462	6 x 1 1/4"		2	35	33
S-20531	12 x 1 1/4"	12	2	35	33
S-20533	24 x 1 1/4"				

**ANGLED**

S-20951	3 x 1 1/4"	25	1	\$28	\$27
S-20952	6 x 1 1/4"		2	46	44

# ADDITIONAL SHELVES

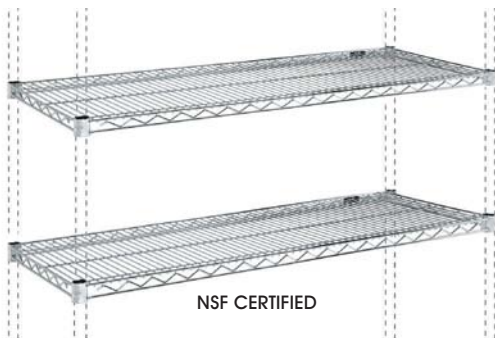

NSF CERTIFIED

Add extra shelves to Wire Shelving Units.

- Includes snap-on plastic shelf supports.
- Chrome-plated and black powder-coated steel resists rust and corrosion.
- Easy assembly. No tools required.
- Additional sizes available, see uline.com

■ SHIPS VIA MOTOR FREIGHT

**2 SHELVES PER BOX**

MODEL NO.	SHELF W x D	SHELF CAP. (LBS.)	WT. (LBS.)	BLACK		CHROME	
				PRICE PER BOX		PRICE PER BOX	
				1	3+	1	3+
H-3177	24 x 12"	350	12	\$48	\$44	\$51	\$47
H-3178	36 x 12"	350	13	56	51	60	55
H-3179	48 x 12"	350	16	64	60	67	63
H-3180	24 x 18"	800	14	55	50	59	54
H-3197	30 x 18"	800	17	60	55	63	59
H-3181	36 x 18"	800	20	63	59	66	62
H-3182	48 x 18"	800	26	78	74	81	77
H-3183	60 x 18"	650	34	92	88	102	95
H-3184	72 x 18"	650	40	109	105	116	111
H-3185	24 x 24"	800	18	63	59	66	62
H-3186	36 x 24"	800	28	70	65	75	69
H-3187	48 x 24"	800	35	93	89	99	92
H-3188	60 x 24"	650	42	113	109	117	112
■H-3189	72 x 24"	650	54	146	142	149	145
H-6728	48 x 30"	800	48	132	127	147	142
H-6729	60 x 30"	650	60	148	144	167	163
■H-6730	72 x 30"	650	72	181	175	197	193
H-3198	48 x 36"	800	51	148	144	163	159
■H-3190	60 x 36"	650	64	162	158	193	189
■H-3191	72 x 36"	650	78	198	193	218	212



# BLACK HEAVY-DUTY WIRE CARTS

Durable carts for offices, stores and warehouses.

- Tough and maneuverable. Easily move large, heavy loads.
- Powder-coated carbon steel. • Easy to clean; won't collect dirt.
- Adjustable shelf height. • 5" lockable swivel casters.

MODEL NO.	OVERALL DIM. L x W x H	SHELF QTY.	CAPACITY (LBS.)	WT. (LBS.)	PRICE EACH	
					1	3+
H-6785	36 x 18 x 41"	2	1,000	37	\$160	\$150
H-6786	48 x 18 x 41"			43	170	160
H-6787	48 x 24 x 41"	2	1,000	50	190	180
H-6788	60 x 24 x 41"			52	220	210

SHIPS UNASSEMBLED VIA UPS



H-6788

## WIRE SHELVING ACCESSORIES

### SIDE AND BACK LEDGES

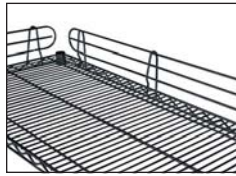

Prevent items from falling off the shelf. 4" high. Snaps on.

MODEL NO.	SIZE W x H	WT. (LBS.)	PRICE EACH	
			4	12+
H-2429	12 x 4"	1	\$5.90	\$5.55
H-1767	18 x 4"	1	6.60	6.25
H-1763	24 x 4"	1	7.15	6.85
H-6791	30 x 4"	2	9.00	8.60
H-1764	36 x 4"	2	9.55	9.20
H-1765	48 x 4"	2	11.90	11.45
H-1768	60 x 4"	3	16.00	15.55
H-1769	72 x 4"	3	19.65	19.05

SPECIFY COLOR: Chrome or Black

### DIVIDERS

MODEL NO.	SIZE D x H	WT. (LBS.)	PRICE EACH	
			4	12+
H-2983	12 x 8"	1	\$7.70	\$7.35
H-1760	18 x 8"	1	8.30	8.00
H-1761	24 x 8"	2	9.55	9.20
H-6792	30 x 8"	2	13.85	13.55
H-1762	36 x 8"	3	17.85	17.40

SPECIFY COLOR: Chrome or Black

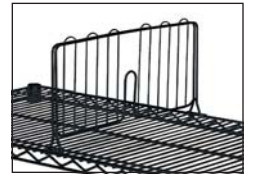

Keep contents organized. Easily snap into place.

### WIRE SHELVING SUPPORTS



Replacement plastic supports grip and hold shelves in place.

MODEL NO.	QTY./PACK	LBS./PACK	PRICE/PACK	
			1	3+
H-1205-SPRT	4	1	\$7.15	\$6.85

### HANGING UTILITY BASKET

Attach to shelving or carts for added storage.

MODEL NO.	SIZE W x D x H	CAP. (LBS.)	PRICE EACH	
			1	3+
H-4841	19 x 11 x 8"	50	\$28	\$26

SPECIFY COLOR: Chrome or Black



### POLYURETHANE CASTERS



5" polyurethane stem casters add mobility to your wire shelving.

- Swivel, lockable.
- Adds 6" to height of shelving unit.

SPECIFY COLOR: Chrome or Black

MODEL NO.	CAP./SET (LBS.)	WT. (LBS.)	PRICE/SET	
			1	3+
H-1205WH	1,000	12	\$75	\$72

Sold in sets of 4

### PUSH HANDLES

Easily move wire shelving on sliding tracks or casters.

SPECIFY COLOR: Chrome or Black

MODEL NO.	FOR SHELVING DEPTH	WT. (LBS.)	PRICE EACH	
			2	6+
H-2928	18"	3	\$17	\$16
H-2929	24"	4	19	18



### PNEUMATIC CASTERS



Chubby 8" rubber stem casters roll smoothly over rough surfaces.

- Swivel, lockable.
- Adds 10" to height of shelving unit.

Sold in sets of 4

MODEL NO.	CAP./SET (LBS.)	WT. (LBS.)	PRICE/SET	
			1	3+
H-7569	1,000	30	\$180	\$175

### WIRE SHELVING POSTS

For use with Wire Shelving.

- Includes leveling feet. • Black, see uline.com

CHROME

SHIPS VIA MOTOR FREIGHT

MODEL NO.	SIZE	PRICE/BOX OF 2		MODEL NO.	SIZE	PRICE/BOX OF 2	
		1	3+			1	3+
H-6794	34"	\$20	\$17	H-6797	72"	\$36	\$34
H-6795	54"	32	29	H-6798	86"	45	42
H-6796	63"	33	30	H-6799	96"	53	49



## SECURITY CARTS



Safely store and transport costly items to reduce theft.

- Lockable double doors for maximum security.
- Two heavy-duty shelves adjust in 1" increments.
- Maneuvers easily on 5" lockable swivel casters.
- Security Cart Covers, see [uline.com](http://uline.com)



Wire Security Cages,  
see page 464

MODEL NO.	DIMENSIONS L x W x H	SHELF QTY.	CAPACITY (LBS.)	WT. (LBS.)	PRICE EACH	
					1	3+
H-2656	36 x 18 x 69"			166	\$615	\$595
H-2083	36 x 24 x 69"	3	1,000	192	675	650
H-2657	48 x 18 x 69"			197	680	655
H-2084	48 x 24 x 69"			222	740	715
H-2658	60 x 18 x 69"	3	1,000	235	790	765
H-2085	60 x 24 x 69"			260	845	820
H-6752	72 x 24 x 69"			308	940	915

SHIPS UNASSEMBLED VIA MOTOR FREIGHT

## STOCK PICKER CARTS



Stock shelves quickly and safely from these wire carts.

- Keep items from falling out.
- Glides easily on 5" lockable swivel casters.
- Three heavy-duty shelves adjust in 1" increments.
- Easy to assemble.

MODEL NO.	DIMENSIONS L x W x H	SHELF QTY.	CAPACITY (LBS.)	WT. (LBS.)	PRICE EACH	
					1	3+
H-2653	36 x 18 x 69"	4	1,000	128	\$500	\$480
H-1789	36 x 24 x 69"			154	555	535
H-2654	48 x 18 x 69"			151	560	540
H-1790	48 x 24 x 69"			178	615	595
H-2655	60 x 18 x 69"	4	1,000	178	665	645
H-2082	60 x 24 x 69"			206	720	700
H-6753	72 x 24 x 69"			240	815	795

SHIPS UNASSEMBLED VIA MOTOR FREIGHT

## RESTOCKING CARTS



Deliver parts and supplies in dividable bins to replenish workstations.

- Bins slide in and out for easy access.
- 5" locking swivel casters.
- Shown with optional dividers, see page 503.

SHIPS UNASSEMBLED VIA UPS

SPECIFY BIN COLOR: Blue or Gray

MODEL NO.	CART DIM. L x W x H	BIN SIZE L x W x H	BINS/CART	WT. (LBS.)	PRICE EACH	
					1	3+
H-7027	24 x 21 x 40"	20 x 15 x 6"	4	60	\$355	\$340
H-7028	24 x 21 x 69"		7	86	470	455

## WIRE CARTS



Push heavy loads through small aisles and tight spaces.

- 2 adjustable shelves.
- 5" locking swivel casters.
- Push Handles available, see page 457.

SHIPS UNASSEMBLED VIA UPS

Black Wire Carts, see [uline.com](http://uline.com)

MODEL NO.	DIMENSIONS L x W x H	SHELF QTY.	CAPACITY (LBS.)	WT. (LBS.)	PRICE EACH	
					1	3+
H-4378	36 x 18 x 40"	2	1,000	39	\$155	\$145
H-4379	36 x 24 x 40"			46	170	160
H-4380	48 x 24 x 40"			53	190	180

# MOBILE SHELVING



Tough, heavy-duty maneuverable carts move large loads.

- 4 Shelf – Longer posts give more space for larger items. Greater capacity for fewer trips.
- Easy to clean; won't collect dirt.
- Shelves adjust in 1" increments.
- 5" locking swivel casters included.
- NSF certified.
- Push Handles and other Wire Shelving accessories, see pages 456-457.



## 69" HEIGHT

MODEL NO.	DIMENSIONS W x D x H	SHELF QTY.	CAP. (LBS.)	PRICE EACH		WT. (LBS.)
				1	3+	
H-3885	36 x 18 x 69"	4	1,000	\$230	\$220	62
H-3155	36 x 24 x 69"			245	235	75
H-3156	48 x 18 x 69"			255	245	73
H-3157	48 x 24 x 69"			290	280	87
H-8275	60 x 18 x 69"	4	1,000	295	285	92
H-3158	60 x 24 x 69"			320	310	107
H-6711	72 x 18 x 69"			320	310	104
■H-5455	72 x 24 x 69"			375	365	136

■ SHIPS UNASSEMBLED VIA MOTOR FREIGHT

## 78" HEIGHT

MODEL NO.	DIMENSIONS W x D x H	SHELF QTY.	CAP. (LBS.)	PRICE EACH		WT. (LBS.)
				1	3+	
H-4254	36 x 18 x 78"	4	1,000	\$245	\$235	64
H-4255	36 x 24 x 78"			255	245	77
H-4256	48 x 18 x 78"			265	255	75
H-4257	48 x 24 x 78"			300	290	89
H-8276	60 x 18 x 78"			310	300	94
H-4258	60 x 24 x 78"	4	1,000	330	320	109
H-6712	72 x 18 x 78"			330	320	106
■H-5456	72 x 24 x 78"			385	375	138

■ SHIPS UNASSEMBLED VIA MOTOR FREIGHT

# HEAVY-DUTY WIRE CARTS



Tough, maneuverable carts move large loads.

- Recommended for labs, food service, offices and hospitals.
- Adjustable shelf height.
- Easy to clean; won't collect dirt.
- 5" lockable swivel casters.

## 2 SHELF

MODEL NO.	OVERALL DIM. L x W x H	SHELF QTY.	CAP. (LBS.)	PRICE EACH		WT. (LBS.)
				1	3+	
H-2659	36 x 18 x 41"	2	1,000	\$165	\$155	37
H-1418	48 x 18 x 41"			175	165	43
H-1753	60 x 18 x 41"			210	200	47
H-1419	48 x 24 x 41"	2	1,000	200	190	50
H-1518	60 x 24 x 41"			225	215	52
■H-1755	72 x 24 x 41"			265	250	57

■ SHIPS UNASSEMBLED VIA MOTOR FREIGHT

## 3 SHELF

MODEL NO.	OVERALL DIM. L x W x H	SHELF QTY.	CAP. (LBS.)	PRICE EACH		WT. (LBS.)
				1	3+	
H-2660	36 x 18 x 41"	3	1,000	\$185	\$175	44
H-1519	48 x 18 x 41"			200	190	46
H-1756	60 x 18 x 41"			235	225	57
H-1520	48 x 24 x 41"	3	1,000	225	215	56
H-1521	60 x 24 x 41"			250	240	68
■H-1758	72 x 24 x 41"			295	280	84

■ SHIPS UNASSEMBLED VIA MOTOR FREIGHT



# SLANTED WIRE SHELVING



Easily access products or assemble kits in your warehouse.

- Shelves adjust in 1" increments.
- Assemble in minutes. No tools required.
- Optional 5" polyurethane swivel casters.

**5 Shelf Unit with Bins** – Includes 16 durable plastic bins for small parts storage.

## 5 SHELF UNITS

MODEL NO.	DIMENSIONS W x D x H	NO. OF SHELVES	SHELF CAP. (LBS.)	PRICE EACH		WT. (LBS.)
				1	3+	
H-3793	48 x 18 x 63"	5	400	\$300	\$290	72
■H-3794	48 x 24 x 63"			355	345	80
H-3124	36 x 18 x 72"	5	400	250	240	60
H-3125	48 x 18 x 72"			315	305	74
H-3126	36 x 24 x 72"	5	400	305	295	67
■H-3127	48 x 24 x 72"			365	355	82
H-1205WH	Set of 4 Lockable Casters			75	72	12

■ SHIPS UNASSEMBLED VIA MOTOR FREIGHT

## 5 SHELF UNIT WITH BINS

SPECIFY BIN COLOR: Blue, Red, Yellow, Green, White, Black or Clear

MODEL NO.	DIMENSIONS W x D x H	BIN SIZE L x W x H	BINS/UNIT	PRICE EACH	WT. (LBS.)
H-3128	48 x 18 x 72"	18 x 11 x 10"	16	\$530	122

# MOBILE SHELVING COVERS



HEAVY DUTY



DELUXE



CLEAR

\* SPECIFY COLOR: Blue or Black

Protect shelf contents from dust, debris, water and "prying eyes."

- Slip easily over mobile, wire and slanted shelving.
- Flexible, water-resistant material. Fold and store when not in use.

**Heavy Duty** – Durable nylon with hook and loop closure. Reinforced corners.

**Deluxe** – Clear PVC zippered front lets you easily see contents.

**Clear** – Clear PVC provides full visibility. Zippered front.

MODEL NO.	FITS CARTS W x D x H	HEAVY DUTY*			DELUXE			CLEAR		
		PRICE EACH		WT. (LBS.)	PRICE EACH		WT. (LBS.)	PRICE EACH		WT. (LBS.)
		1	3+		1	3+		1	3+	
H-4792	36 x 18 x 69"	\$89	\$79	3	\$99	\$89	3	\$109	\$99	3
H-3815	36 x 24 x 69"	99	89	4	109	99	4	119	109	4
H-3814	48 x 18 x 69"	99	89	4	109	99	4	119	109	4
H-3816	48 x 24 x 69"	109	99	5	119	109	5	129	119	5
H-3817	60 x 24 x 69"	119	109	5	129	119	5	139	129	5
H-5459	72 x 24 x 69"	129	119	6	139	129	6	149	139	6
H-5460	36 x 18 x 78"	99	89	3	109	99	3	119	109	3
H-5461	36 x 24 x 78"	109	99	4	119	109	4	129	119	4
H-5462	48 x 18 x 78"	109	99	4	119	109	4	129	119	4
H-5463	48 x 24 x 78"	119	109	5	129	119	5	139	129	5
H-5464	60 x 24 x 78"	129	119	5	139	129	5	149	139	5
H-5465	72 x 24 x 78"	139	129	6	149	139	6	159	149	6

# BLACK MOBILE SHELVING



Decorative, maneuverable heavy-duty carts look good in offices, stores and warehouses.

- 4 Shelf – Longer posts give more space for larger items. Greater capacity for fewer trips.
- Easy to clean; won't collect dirt.
- Shelves adjust in 1" increments.
- 5" locking swivel casters included.
- NSF certified.
- Wire Shelving accessories, see pages 456-457.



## 69" HEIGHT

MODEL NO.	DIMENSIONS W x D x H	SHELF QTY.	CAPACITY (LBS.)	PRICE EACH		WT. (LBS.)
				1	3+	
H-3885BL	36 x 18 x 69"	4	1,000	\$220	\$210	62
H-3155BL	36 x 24 x 69"			230	220	75
H-3156BL	48 x 18 x 69"			245	235	73
H-3157BL	48 x 24 x 69"			275	265	87
H-3158BL	60 x 24 x 69"			310	300	107
■H-5455BL	72 x 24 x 69"			365	355	136

■ SHIPS UNASSEMBLED VIA MOTOR FREIGHT

## 78" HEIGHT

MODEL NO.	DIMENSIONS W x D x H	SHELF QTY.	CAPACITY (LBS.)	PRICE EACH		WT. (LBS.)
				1	3+	
H-4254BL	36 x 18 x 78"	4	1,000	\$230	\$220	64
H-4255BL	36 x 24 x 78"			245	235	77
H-4256BL	48 x 18 x 78"			255	245	75
H-4257BL	48 x 24 x 78"			285	275	89
H-4258BL	60 x 24 x 78"			320	310	109
■H-5456BL	72 x 24 x 78"			375	365	138

■ SHIPS UNASSEMBLED VIA MOTOR FREIGHT

# TWO SHELF ADJUSTABLE WIRE SHELVING

Recommended for garages and storage rooms where space is tight.

## 2 SHELF STARTER UNITS

MODEL NO.	DIMENSIONS W x D x H	SHELF CAP. (LBS.)	BLACK			CHROME		
			PRICE EACH		WT. (LBS.)	PRICE EACH		WT. (LBS.)
			1	3+		1	3+	
H-2935-34	24 x 12 x 34"	350	\$76	\$69	19	\$81	\$76	19
H-2936-34	36 x 12 x 34"	350	82	77	21	87	82	21
H-2937-34	48 x 12 x 34"	350	89	83	24	95	89	24
H-2938-34	24 x 18 x 34"	800	82	77	23	87	82	23
H-2940-34	36 x 18 x 34"	800	87	82	27	93	87	27
H-2941-34	48 x 18 x 34"	800	101	95	33	107	101	33
H-2942-34	60 x 18 x 34"	650	119	113	42	125	119	42
H-2943-34	72 x 18 x 34"	650	140	132	48	145	140	48
H-2944-34	24 x 24 x 34"	800	87	82	30	93	87	30
H-2945-34	36 x 24 x 34"	800	93	87	34	100	93	34
H-2946-34	48 x 24 x 34"	800	119	113	43	125	119	43
H-2947-34	60 x 24 x 34"	650	140	132	50	145	140	50
■H-2948-34	72 x 24 x 34"	650	170	164	62	176	170	62
H-2949-34	48 x 36 x 34"	800	200	194	59	206	200	59
■H-2950-34	60 x 36 x 34"	650	211	206	71	218	211	71
■H-2951-34	72 x 36 x 34"	650	225	219	86	230	225	86
H-1205WH	Set of 4 Lockable Casters		75	72	12	75	72	12

■ SHIPS UNASSEMBLED VIA MOTOR FREIGHT



- NSF certified shelves adjust in 1" increments.
- Assemble in minutes. No tools required.
- Open wire maximizes airflow, reduces dust.
- Optional 5" polyurethane swivel casters for portability.
- Add-On Units and accessories available, see [uline.com](http://uline.com)

# WIRE BASKET SHELVING

Keep loose items organized and visible in stores, stockrooms and fulfillment areas.

- Baskets prevent items from falling off.
- Open wire maximizes airflow, reduces dirt and dust buildup.
- Shelves adjust in 1" increments.
- Basket Dividers create various compartments.
- NSF certified.
- Optional 5" polyurethane swivel casters.



## 63" HEIGHT

MODEL NO.	DIMENSIONS W x D x H	NO. OF SHELVES	SHELF CAP. (LBS.)	WT. (LBS.)	PRICE EACH	
					1	3+
H-6215	36 x 18 x 63"	5	300	66	\$240	\$230
H-6216	48 x 18 x 63"				275	265
H-6217	36 x 24 x 63"	5	300	81	275	265
H-6218	48 x 24 x 63"				325	315
H-1205WH	Set of 4 Lockable Casters			12	75	72

SHIPS UNASSEMBLED VIA UPS

## 72" HEIGHT

MODEL NO.	DIMENSIONS W x D x H	NO. OF SHELVES	SHELF CAP. (LBS.)	WT. (LBS.)	PRICE EACH	
					1	3+
H-8331	36 x 18 x 72"	5	300	68	\$250	\$235
H-8332	48 x 18 x 72"				285	275
H-8333	36 x 24 x 72"	5	300	83	285	275
H-8334	48 x 24 x 72"				335	325
H-1205WH	Set of 4 Lockable Casters			12	75	72

SHIPS UNASSEMBLED VIA UPS

## ADDITIONAL BASKETS

MODEL NO.	DIMENSIONS W x D	WT. (LBS.)	PRICE EACH	
			1	3+
H-6227	36 x 18"	10	\$57	\$55
H-6229	48 x 18"	13	69	63
H-6228	36 x 24"	14	61	59
H-6230	48 x 24"	18	79	76

## BASKET DIVIDERS

MODEL NO.	DIMENSIONS D x H	WT. (LBS.)	PRICE/DIVIDER	
			3	9+
H-6225	18 x 10"	1	\$11.25	\$10.75
H-6226	24 x 10"	2	12.25	11.75

MIN. 3



# MAIL CARTS



H-2862



H-1200



H-1199

Quickly facilitate office mail and small package delivery.

- 2 removable baskets for sorting and loading.
- File capacity – 80 to 120 letter or legal-size folders.

EASY ASSEMBLY

■ SHIPS UNASSEMBLED VIA MOTOR FREIGHT

MODEL NO.	DIMENSIONS L x W x H	FILE CAPACITY	CASTERS	WT. (LBS.)	PRICE EACH	
					1	3+
H-1199	27 x 19 x 38"	80 - 100	4" Swivel / 4" Rigid	49	\$250	\$240
H-1200	30 x 23 x 38"	80 - 100	5" Swivel / 10" Rigid	52	290	280
■H-2862	42 x 23 x 38"	100 - 120	5" Swivel / 10" Rigid	65	395	375

**H-1200 and H-2862 – Recommended for heavy loads or longer distances.**



# SLIDING STORAGE SHELVES

Turn aisles into usable space and increase storage up to 43%.

- Chrome-plated steel units glide effortlessly on snap-together tracks.
- Easy assembly – No tools needed. Works on any smooth floor.
- Safety brakes keep shelves stationary while loading and unloading.
- Shelves adjust in 1" increments. NSF certified.
- Handles, shelf liners and other accessories available, see pages 456-457.



H-2901

## 4-SHELF UNITS

MODEL NO.	SHELF SIZE	OVERALL DIM. W x L x H	NO. OF UNITS	AISLE SPACE	SHELF CAP.	WT. (LBS.)	PRICE EACH	
							1	2+
H-2901	48 x 18"	48 x 98 x 74"	3	38"	800 lbs.	226	\$990	\$935
H-2902	60 x 18"	60 x 98 x 74"			650 lbs.	280	1,120	1,065
H-2903	48 x 18"	48 x 138 x 74"	5	38"	800 lbs.	374	1,555	1,450
H-2904	60 x 18"	60 x 138 x 74"			650 lbs.	464	1,770	1,665
H-2905	48 x 24"	48 x 118 x 74"	3	40"	800 lbs.	273	1,095	1,045
H-2906	60 x 24"	60 x 118 x 74"			650 lbs.	333	1,250	1,195
H-2907	48 x 24"	48 x 177 x 74"	5	47"	800 lbs.	453	1,795	1,685
H-2908	60 x 24"	60 x 177 x 74"			650 lbs.	553	2,030	1,925
■H-5435	72 x 24"	72 x 177 x 74"			650 lbs.	676	2,240	2,135

■ SHIPS UNASSEMBLED VIA MOTOR FREIGHT

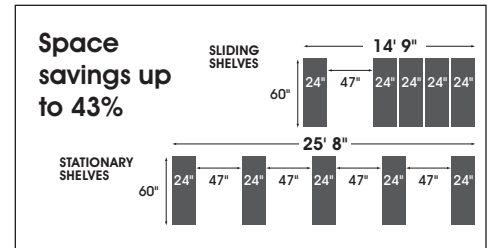

# TOP-TRACK SHELVING

Maximize your storage in limited space. Ideal for stockrooms, return departments and small warehouses.

- Shelving system increases storage up to 43%.
- Overhead track keeps floor clear for safety and cleaning.
- Pull handle releases middle mobile units from track. 5" locking swivel casters.
- Chrome-plated steel. Shelves adjust in 1" increments. Easy assembly.



H-9823

## 4-SHELF UNITS

Accessories available, see pages 456-457

MODEL NO.	SHELF SIZE	OVERALL DIM. W x L x H	STATIONARY UNITS	MOBILE UNITS	AISLE SPACE	SHELF CAP.	WT. (LBS.)	PRICE EACH	
								1	2+
H-9823	60 x 24"	60 x 135 x 72"	2	2	36"	650 lbs.	436	\$1,725	\$1,650
■H-9824	72 x 24"	72 x 135 x 72"						532	1,900
H-9825	60 x 24"	60 x 166 x 72"	2	3	42"	650 lbs.	551	2,250	2,150
■H-9826	72 x 24"	72 x 166 x 72"						671	2,450

■ SHIPS UNASSEMBLED VIA MOTOR FREIGHT

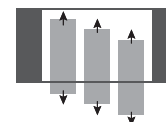

Middle mobile units release from track and roll to other areas.



## WALL-MOUNT WIRE SHELVING

Add storage above work areas in restaurants, offices and pharmaceutical plants.

- Open wire design reduces dust buildup.
- Shelves adjust in 1" increments.
- Includes mounting hardware.
- NSF certified.
- Chrome finish resists rust and corrosion.



MODEL NO.	DIMENSIONS W x D x H	SHELF QTY.	SHELF CAP. (LBS.)	PRICE EACH		WT. (LBS.)
				1	3+	
H-4795	36 x 18 x 14"			\$80	\$75	18
H-4796	48 x 18 x 14"	1	250	90	85	20
H-4797	60 x 18 x 14"			125	120	26
H-5436	36 x 12 x 34"	2	250	130	125	26
H-5437	48 x 12 x 34"	2	250	140	135	28
H-3023	24 x 18 x 34"	2	250	160	150	27

SHIPS UNASSEMBLED VIA UPS

MODEL NO.	DIMENSIONS W x D x H	SHELF QTY.	SHELF CAP. (LBS.)	PRICE EACH		WT. (LBS.)
				1	3+	
H-3025	36 x 18 x 34"			\$170	\$160	33
H-3026	48 x 18 x 34"	2	250	185	175	38
H-3027	60 x 18 x 34"			200	190	47
H-6721	36 x 18 x 63"	4	250	290	280	66
H-6722	48 x 18 x 63"	4	250	310	300	77
H-6723	60 x 18 x 63"			340	320	95

SHIPS UNASSEMBLED VIA UPS



## BIN CART

Pick orders, deliver mail or roll assembly parts.

- Shelves adjust in 1" increments. 4" side and back ledges.
- Polyethylene bins with molded label holder.
- 10" rear pneumatic wheels, 5" front locking swivel casters.

NSF Certified

MODEL NO.	DESCRIPTION	DIMENSIONS L x W x H	CAP. (LBS.)	PRICE EACH		WT. (LBS.)
				1	3+	
H-3906	Cart Only	42 x 26 x 61"	1,000	\$435	\$425	112
H-3907	Cart with Bins	(15) 20 x 11 x 8" Bins		780	760	134

SHIPS UNASSEMBLED VIA UPS

## WIRE BASKET CARTS

Contain dishes, packages and jars during transport.

- One 4" deep basket and two 1" deep shelves.
- Ergonomic, angled handle.
- 5" locking swivel casters.



Lipped edges keep product in place.



NSF Certified

MODEL NO.	DIMENSIONS L x W x H	SHELF QTY.	CAPACITY (LBS.)	PRICE EACH		WT. (LBS.)
				1	3+	
H-10385	36 x 18 x 40"			\$210	\$200	49
H-10386	36 x 24 x 40"	3	1,000	235	225	57
H-10387	48 x 24 x 40"			260	250	68

SHIPS UNASSEMBLED VIA UPS

## WIRE SECURITY CAGES

Provides security and visibility to valuable tools, parts and inventory.

- Double doors are lockable for maximum security. Swing open a full 180°.
- Open wire reduces dust buildup.
- Two heavy-duty shelves adjust in 1" increments.
- Self-leveling footplates for uneven floor. Anchor to floor for extra stability.

MODEL NO.	DIMENSIONS W x D x H	SHELF QTY.	SHELF CAP. (LBS.)	PRICE EACH		WT. (LBS.)
				1	3+	
H-8396	48 x 24 x 63"		800	\$665	\$645	216
H-8397	60 x 24 x 63"	3	650	770	750	250
H-8398	72 x 24 x 63"		650	865	845	298

Anchoring hardware included

SHIPS UNASSEMBLED VIA MOTOR FREIGHT



Padlocks available, see pages 514-515.



H-8396

# EPOXY MOBILE SHELVING



Roll it out. Easily clean that messy freezer.

- Recommended for walk-in coolers, commercial kitchens and dining halls.
- Chemical-resistant epoxy coating withstands harsh cleaning, salt and water.
- Shelves adjust in 1" increments. • NSF certified.
- 5" locking polyurethane swivel casters.



## 69" HEIGHT

SPECIFY COLOR: Zinc or Green

MODEL NO.	DIMENSIONS W x D x H	SHELF QTY.	CAPACITY (LBS.)	PRICE EACH		WT. (LBS.)
				1	3+	
H-10441	48 x 24 x 69"	4	1,000	\$360	\$350	87
H-10442	60 x 24 x 69"			405	395	107
■H-10443	72 x 24 x 69"			470	460	136

■ SHIPS UNASSEMBLED VIA MOTOR FREIGHT

## 78" HEIGHT

SPECIFY COLOR: Zinc or Green

MODEL NO.	DIMENSIONS W x D x H	SHELF QTY.	CAPACITY (LBS.)	PRICE EACH		WT. (LBS.)
				1	3+	
H-10444	48 x 24 x 78"	4	1,000	\$370	\$360	89
H-10445	60 x 24 x 78"			415	405	109
■H-10446	72 x 24 x 78"			480	470	138

■ SHIPS UNASSEMBLED VIA MOTOR FREIGHT



# VENTED PLASTIC SHELVING

Pop off shelves and run through dishwasher. The chef's choice for easy cleaning and sanitizing.

- Microban® antimicrobial protection prevents mold and bacteria growth in food service areas.
- Rustproof polypropylene shelf mats. Shelves adjust in 1" increments.
- NSF certified.
- Optional swivel casters available, see [uline.com](http://uline.com)



## METROMAX Q™

MODEL NO.	DIMENSIONS W x D x H	SHELF QTY.	SHELF CAP. (LBS.)	PRICE EACH		WT. (LBS.)
				1	3+	
H-6205	36 x 18 x 74"	4	800	\$480	\$460	61
H-6206	48 x 18 x 74"			550	530	75
H-6207	36 x 24 x 74"	4	800	550	530	75
H-6208	48 x 24 x 74"			655	635	86

Additional shelves available, see [uline.com](http://uline.com)

SHIPS UNASSEMBLED VIA UPS

# STAINLESS STEEL SECURITY CARTS

Safely store and transport valuable goods in commercial kitchens and labs.

- Type 304 stainless steel will not rust. Resists the harshest conditions.
- Lockable double doors for maximum security. Use with padlocks, see page 514.
- Two heavy-duty shelves adjust in 1" increments. • Open wire design for visibility.

MODEL NO.	DIMENSIONS L x W x H	SHELF QTY.	CAPACITY (LBS.)	PRICE EACH		WT. (LBS.)
				1	3+	
H-6839	36 x 24 x 69"	3	1,000	\$1,470	\$1,420	192
H-6840	48 x 24 x 69"			1,685	1,635	233
H-6841	60 x 24 x 69"			1,850	1,800	270

SHIPS UNASSEMBLED VIA MOTOR FREIGHT

- Maneuvers easily on 5" lockable stainless steel swivel casters.







# EPOXY WIRE SHELVING

Coated shelving provides superior chemical resistance.

- Recommended for wet environments, labs and kitchen coolers.
- Epoxy coating withstands harsh cleaning, salt and water.
- Shelves adjust in 1" increments.
- NSF certified.
- Optional 5" locking polyurethane swivel casters for portability.
- Specify color: Zinc or Green.



4 SHELF UNITS		63" HEIGHT				72" HEIGHT				86" HEIGHT				
DIMENSIONS W x D	SHELF CAP. (LBS.)	MODEL NO.	PRICE EACH		WT. (LBS.)	MODEL NO.	PRICE EACH		WT. (LBS.)	MODEL NO.	PRICE EACH		WT. (LBS.)	
			1	3+			1	3+			1	3+		
36 x 18"	800	H-6763	\$203	\$192	53	H-6771	\$215	\$203	55	H-8284	\$227	\$215	57	
48 x 18"	800	H-6764	226	215	64	H-4306	237	226	66	H-8285	248	237	68	
60 x 18"	650	H-6765	282	271	82	H-3818	294	282	84	H-8286	307	294	86	
72 x 18"	650	H-6766	351	339	94	H-6772	362	351	96	H-8287	375	362	98	
36 x 24"	800	H-6767	226	215	66	H-4307	237	226	68	H-8288	248	237	70	
48 x 24"	800	H-6768	294	282	78	H-3819	306	294	80	H-8289	316	306	82	
60 x 24"	650	H-6769	339	329	98	H-3820	351	339	100	H-8290	361	351	102	
72 x 24"	650	■H-6770	408	396	122	■H-3821	419	408	124	■H-8291	431	419	126	
H-1205WH	Set of 4 Polyurethane Casters					1/\$75 3+/\$72				12	■SHIPS UNASSEMBLED VIA MOTOR FREIGHT			

## ADDITIONAL SHELVES

MODEL NO.	DIMENSIONS W x D	QTY./ BOX	PRICE PER BOX		WT. (LBS.)
			1	3+	
H-6776	36 x 18"	2	\$101	\$96	20
H-6777	48 x 18"		106	102	26
H-6778	60 x 18"		133	128	34
H-6779	72 x 18"		167	162	40
H-6780	36 x 24"	2	107	103	28
H-6781	48 x 24"		137	131	35
H-6782	60 x 24"		166	161	42
■H-6783	72 x 24"		192	188	54

■SHIPS UNASSEMBLED VIA MOTOR FREIGHT



## TWO-SHELF WIRE SHELVING New



Maximize storage in small coolers, stockrooms and diners.

- Epoxy coating withstands harsh cleaning, salt and water. Chemical-resistant.
- Shelves easily adjust in 1" increments.

NSF Certified

SPECIFY COLOR: Zinc or Green

MODEL NO.	DIMENSIONS W x D x H	SHELF QTY.	SHELF CAP. (LBS.)	PRICE EACH		WT. (LBS.)
				1	3+	
H-10437	24 x 12 x 34"	2	350	\$100	\$95	19
H-10438	24 x 18 x 34"			105	100	23
H-10439	36 x 18 x 34"		800	115	110	27
H-10440	48 x 18 x 34"			130	125	33

## ALUMINUM DUNNAGE RACKS

Keep ingredients and produce off the floor.

- All-welded bulk storage for coolers and freezers.
- Won't rust or corrode in extreme environments.



NSF Certified

■SHIPS VIA MOTOR FREIGHT

MODEL NO.	DIMENSIONS W x D x H	CAPACITY (LBS.)	PRICE EACH		WT. (LBS.)
			1	3+	
H-7494	36 x 20 x 12"	2,000	\$87	\$82	8
H-7495	36 x 24 x 12"		99	92	10
■H-7496	48 x 20 x 12"	2,000	99	92	10
■H-7497	48 x 24 x 12"		115	110	12



## STAINLESS MOBILE SHELVING

Trustworthy and durable. Store and transport everything you need for your lab or kitchen.

- Type 304 stainless steel absolutely will not rust.
- Open wire maximizes airflow, reduces dirt and dust buildup. Easy to clean.
- Shelves adjust in 1" increments.
- NSF certified.
- 5" stainless steel locking swivel casters.



### 69" HEIGHT

MODEL NO.	DIMENSIONS W x D x H	SHELF QTY.	CAPACITY (LBS.)	PRICE EACH		WT. (LBS.)
				1	3+	
H-10453	36 x 18 x 69"	4	1,000	\$680	\$660	66
H-10454	36 x 24 x 69"			725	705	81
H-10455	48 x 18 x 69"			740	720	78
H-9486	48 x 24 x 69"			840	820	96
H-10456	60 x 18 x 69"	4	1,000	825	805	90
H-9487	60 x 24 x 69"			965	945	114
■H-9488	72 x 24 x 69"			1,145	1,125	130

■ SHIPS UNASSEMBLED VIA MOTOR FREIGHT

### 78" HEIGHT

MODEL NO.	DIMENSIONS W x D x H	SHELF QTY.	CAPACITY (LBS.)	PRICE EACH		WT. (LBS.)
				1	3+	
H-10457	36 x 18 x 78"	4	1,000	\$690	\$670	68
H-10458	36 x 24 x 78"			735	715	83
H-10459	48 x 18 x 78"			750	730	80
H-9489	48 x 24 x 78"			850	830	98
H-10460	60 x 18 x 78"	4	1,000	835	815	92
H-9490	60 x 24 x 78"			975	955	116
■H-9491	72 x 24 x 78"			1,155	1,135	132

■ SHIPS UNASSEMBLED VIA MOTOR FREIGHT

## SOLID WALL-MOUNT SHELVING



Add extra storage above kitchen sinks, counters or prep areas.

- Solid, 16-gauge stainless steel.
- NSF certified.
- Includes mounting hardware.

### Type 304 Stainless Steel

MODEL NO.	DIMENSIONS W x D x H	CAPACITY (LBS.)	PRICE EACH		WT. (LBS.)
			1	2+	
H-7498	36 x 12 x 10"	175	\$110	\$105	11
H-7499	48 x 12 x 10"		130	125	15
H-7500	60 x 12 x 10"		150	145	18

EASY ASSEMBLY. SHIPS VIA UPS.

## SOLID TOP WIRE CARTS



Store and transport supplies in kitchens and cleanrooms.

- Solid top shelf for smaller items.
- Shelves adjust in 1" increments.
- Rustproof stainless steel. NSF certified.
- 5" nylon locking swivel casters.

### Type 304 Stainless Steel

MODEL NO.	DIMENSIONS L x W x H	SHELF QTY.	CAPACITY (LBS.)	PRICE EACH		WT. (LBS.)
				1	3+	
H-7488	39 x 18 x 41"	2	1,000	\$480	\$460	44
H-7489	39 x 24 x 41"			540	520	52

SHIPS UNASSEMBLED VIA UPS

## SERVICE CARTS

Compact carts move easily through cafés and hospitals.

- Top 2 shelves have 1" lip with an open front.
- Shelves are 12" apart.
- Bumpers protect walls, tables and doors.
- 4" rubber swivel casters: 2 locking.



### Type 430 Stainless Steel

MODEL NO.	DIMENSIONS L x W x H	SHELF QTY.	CAPACITY (LBS.)	PRICE EACH		WT. (LBS.)
				1	3+	
H-7490	28 x 17 x 33"	3	500	\$230	\$220	39
H-7491	31 x 19 x 33"			265	255	42

SHIPS UNASSEMBLED VIA UPS

# STAINLESS STEEL

## SOLID SHELVING

Top of the line. Smooth, polished shelves contain spills and fall-through.

- Recommended for commercial kitchens, labs and cleanrooms.
- 18-gauge, Type 304 stainless steel with raised edge. Washes down easily.
- Shelves adjust in 1" increments. • NSF certified.
- Optional 5" stainless steel locking swivel casters.

Additional sizes, see [uline.com](http://uline.com)

SHIPS UNASSEMBLED VIA UPS

MODEL NO.	DIMENSIONS W x D x H	NO. OF SHELVES	SHELF CAP. (LBS.)	PRICE EACH		WT. (LBS.)
				1	3+	
H-6815	48 x 24 x 63"	4	800	\$845	\$825	122
H-6816	60 x 24 x 63"		650	1,160	1,135	144
H-5469	48 x 24 x 72"	4	800	855	835	124
H-6817	60 x 24 x 72"		650	1,170	1,145	146
H-4305	Set of 4 Stainless Steel Casters			215	205	12



## WIRE CARTS

Move equipment and supplies through kitchens and hospitals.

- Rustproof. Withstands frequent washdowns.
- Reduces dust buildup with open wire design.
- Shelves adjust in 1" increments.
- 5" nylon swivel casters.



Type 304, NSF Certified

SHIPS UNASSEMBLED VIA UPS

MODEL NO.	OVERALL DIM. L x W x H	SHELF DIM. L x W	SHELF QTY.	CAP. (LBS.)	PRICE EACH		WT. (LBS.)
					1	3+	
H-6819	39 x 18 x 41"	36 x 18"	2	1,000	\$470	\$450	40
H-6820	39 x 24 x 41"	36 x 24"			535	515	48
H-6821	51 x 24 x 41"	48 x 24"			605	585	56

## FLAT SHELF CARTS

Easily unload oversized items in grocery stores and kitchens.

- All-welded, corrosion-resistant stainless steel.
- 1½" deep bottom shelf.
- Shelves are 25" apart.
- 5" polyurethane casters: 2 swivel, 2 rigid.



Type 430

SHIPS ASSEMBLED VIA MOTOR FREIGHT

MODEL NO.	DIMENSIONS L x W x H	LOAD CAPACITY	SHELF QTY.	PRICE EACH		WT. (LBS.)
				1	3+	
H-6825	36 x 18 x 35"	1,200 lbs.	2	\$585	\$565	42
H-6826	42 x 24 x 35"			665	645	56

## TWO-SHELF WIRE SHELVING

Maximize storage in every nook of your kitchens and freezers.

- Corrosion-resistant stainless steel.
- Open wire design reduces dust buildup.
- Shelves adjust in 1" increments.



Type 304, NSF Certified

SHIPS UNASSEMBLED VIA UPS

MODEL NO.	DIMENSIONS W x D x H	SHELF QTY.	SHELF CAP. (LBS.)	PRICE EACH		WT. (LBS.)
				1	3+	
H-8336	24 x 12 x 34"	2	350	\$215	\$205	19
H-8337	36 x 18 x 34"		800	265	255	27
H-8338	48 x 18 x 34"		800	305	295	33

## PLATFORM TRUCKS

Transport ingredients and chemicals from the dock to the production floor.

- Corrosion resistant for sanitary and washdown environments.
- 16-gauge, all-welded stainless steel deck.
- Removable handle.
- 6" casters: 2 swivel, 2 rigid.



Type 430

SHIPS UNASSEMBLED VIA MOTOR FREIGHT

MODEL NO.	DECK SIZE W x L	LOAD CAPACITY	WHEEL TYPE	PRICE EACH		WT. (LBS.)
				1	2+	
H-6348	24 x 36"	1,800 lbs.	Polyurethane	\$710	\$690	63
H-6237	24 x 48"			770	750	76
H-6349	30 x 60"			925	905	95



# STAINLESS STEEL WIRE SHELVING



Twice the price and well worth it. Strong, durable and absolutely will not rust.

- Used in hospitals, labs and restaurants.
- Type 304 stainless steel withstands the harshest environments.
- Open wire maximizes airflow, reduces dirt and dust buildup.
- Shelves adjust in 1" increments.
- NSF certified.
- Optional 5" locking stainless steel casters add 6" to height.
- Additional sizes and accessories available, see [uline.com](http://uline.com)



## 54" HEIGHT

NSF Certified

MODEL NO.	DIMENSIONS W x D x H	NO. OF SHELVES	SHELF CAP. (LBS.)	PRICE EACH		WT. (LBS.)
				1	3+	
H-6943	36 x 18 x 54"	4	800	\$491	\$469	54
H-6944	48 x 18 x 54"		800	545	524	66
H-6947	36 x 24 x 54"		800	534	512	68
H-6948	48 x 24 x 54"		800	653	632	84
H-6949	60 x 24 x 54"		650	783	761	102
H-4305	Set of 4 Stainless Steel Casters			215	205	12

## ADDITIONAL SHELVES (2 PER BOX)

MODEL NO.	PRICE PER BOX		WT. (LBS.)
	1	3+	
H-5481	\$215	\$205	20
H-4300	291	280	26
H-5482	269	258	28
H-4799	356	345	35
H-4303	442	432	42

## 63" HEIGHT

NSF Certified

MODEL NO.	DIMENSIONS W x D x H	NO. OF SHELVES	SHELF CAP. (LBS.)	PRICE EACH		WT. (LBS.)	
				1	3+		
H-6141	48 x 12 x 63"	4	350	\$503	\$481	51	
H-5471	36 x 18 x 63"		800	497	475	56	
H-5472	48 x 18 x 63"		800	550	529	68	
H-5473	60 x 18 x 63"		650	637	615	80	
H-5474	72 x 18 x 63"		650	723	701	94	
H-5475	36 x 24 x 63"		4	800	540	518	71
H-5476	48 x 24 x 63"	800		658	637	86	
H-5477	60 x 24 x 63"	650		789	767	104	
■H-5478	72 x 24 x 63"	650		962	940	120	
■H-6142	72 x 36 x 63"	650		1,189	1,167	170	
H-4305	Set of 4 Stainless Steel Casters				215	205	12

## ADDITIONAL SHELVES (2 PER BOX)

MODEL NO.	PRICE PER BOX		WT. (LBS.)
	1	3+	
H-6145	\$215	\$205	18
H-5481	215	205	20
H-4300	291	280	26
H-4301	345	334	34
H-4302	410	399	40
H-5482	269	258	28
H-4799	356	345	35
H-4303	442	432	42
■H-4801	507	497	54
■H-6146	626	615	78

## 72" HEIGHT

NSF Certified

MODEL NO.	DIMENSIONS W x D x H	NO. OF SHELVES	SHELF CAP. (LBS.)	PRICE EACH		WT. (LBS.)	
				1	3+		
H-6143	48 x 12 x 72"	4	350	\$513	\$492	53	
H-5479	36 x 18 x 72"		800	507	485	58	
H-4295	48 x 18 x 72"		800	562	540	70	
H-4296	60 x 18 x 72"		650	648	626	82	
H-4297	72 x 18 x 72"		650	734	713	96	
H-5480	36 x 24 x 72"		4	800	550	529	73
H-4798	48 x 24 x 72"	800		670	648	88	
H-4298	60 x 24 x 72"	650		799	778	106	
■H-4800	72 x 24 x 72"	650		972	950	122	
■H-6144	72 x 36 x 72"	650		1,199	1,178	172	
H-4305	Set of 4 Stainless Steel Casters				215	205	12

## ADDITIONAL SHELVES (2 PER BOX)

MODEL NO.	PRICE PER BOX		WT. (LBS.)
	1	3+	
H-6145	\$215	\$205	18
H-5481	215	205	20
H-4300	291	280	26
H-4301	345	334	34
H-4302	410	399	40
H-5482	269	258	28
H-4799	356	345	35
H-4303	442	432	42
■H-4801	507	497	54
■H-6146	626	615	78

## 86" HEIGHT

NSF Certified

MODEL NO.	DIMENSIONS W x D x H	NO. OF SHELVES	SHELF CAP. (LBS.)	PRICE EACH		WT. (LBS.)
				1	3+	
H-6152	36 x 24 x 86"	4	800	\$562	\$540	75
H-6153	48 x 24 x 86"		800	680	658	91
H-6154	60 x 24 x 86"		650	810	789	109
■H-6155	72 x 24 x 86"		650	983	962	125
■H-6156	72 x 36 x 86"		650	1,211	1,189	174
H-4305	Set of 4 Stainless Steel Casters			215	205	12

## ADDITIONAL SHELVES (2 PER BOX)

MODEL NO.	PRICE PER BOX		WT. (LBS.)
	1	3+	
H-5482	\$269	\$258	28
H-4799	356	345	35
H-4303	442	432	42
■H-4801	507	497	54
■H-6146	626	615	78

■ SHIPS UNASSEMBLED VIA MOTOR FREIGHT



## PLASTIC SHELVING

Industrial-grade shelves for maintenance rooms and repair shops.

- Chemical-resistant HDPE. Won't chip, dent or rust.
- Sets up easily, simply snap together.
- Four fixed, vented shelves 21 1/2" apart.
- UV protected.

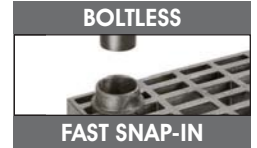

■ SHIPS UNASSEMBLED VIA MOTOR FREIGHT

MODEL NO.	DIMENSIONS W x D x H	NO. OF POSTS	SHELF CAP. (LBS.)	PRICE EACH		WT. (LBS.)
				1	3+	
H-3587	36 x 24 x 75"	12	250	\$395	\$385	59
■H-3588	48 x 24 x 75"	18	340	585	570	82
■H-3589	66 x 24 x 75"	18	460	605	595	105
■H-3590	96 x 24 x 75"	24	675	715	705	151

## PLASTIC DUNNAGE RACKS



Keep bulky items off the floor, away from moisture and dirt.

- Weather resistant for outdoor use at gas stations and garden centers.
- High-density polyethylene resists oils, salts, acids and chemicals.
- Grid top reduces dust buildup. • Made in the USA.

■ SHIPS UNASSEMBLED VIA MOTOR FREIGHT

MODEL NO.	DIMENSIONS W x D x H	CAPACITY (LBS.)	PRICE EACH		WT. (LBS.)
			1	3+	
H-3575	36 x 24 x 12"	500	\$83	\$77	16
H-3576	48 x 24 x 12"	700	135	125	23
■H-3577	66 x 24 x 12"	1,000	140	130	28
■H-3578	96 x 24 x 12"	1,400	170	160	40

## CLEAR STORAGE BOXES

Sterilite®

See-through base allows easy identification of all your office or home stuff.

- Comfortable, innovative recessed latch for easy handling.
- Stackable when storing product. Units nest when not in use.
- Durable polypropylene construction. • Made in the USA.

■ SHIPS VIA MOTOR FREIGHT

MODEL NO.	OUTSIDE DIM. L x W x H	CAPACITY (QTS.)	QTY./ CTN.	PRICE PER CARTON		LBS./ CTN.
				1	3+	
S-14598	18 x 12 x 7"	18	6	\$54	\$51	14
S-14599	18 x 12 x 12"	30	6	70	66	16
■S-14600	26 x 16 x 14"	70	4	84	80	22
■S-14601	33 x 20 x 14"	116	4	135	128	32

## ROLLING TOOL SEAT

Cruise the shop on this mobile mechanic's seat.

- Comfortable 2" padded seat.
- Ball-bearing slide drawer and large bottom tray.
- Durable 2 1/2" swivel casters.

**FREE OFFER**  
FREE upon request with any Uline  
order of \$750 or more.

SPECIFY COLOR: Red or Black

MODEL NO.	DIMENSIONS L x W x H	CAPACITY	PRICE EACH
H-7355	18 x 14 x 14"	250 lbs.	\$50



# BOLTLESS SHELVING



Light-duty storage for breakrooms, stockrooms and small closets.

- Quick, easy assembly with mallet. Shelves snap into place and adjust at 1½" increments.
- 14-gauge powder-coated steel with 5/8" particle board.
- Open design provides easy access on all four sides.
- Additional sizes and shelves available, see [uline.com](http://uline.com)



## 72" HEIGHT

MODEL NO.	DIMENSIONS W x D x H	NO. OF SHELVES	SHELF CAP. (LBS.)	WT. (LBS.)	PRICE EACH	
					1	3+
H-7114	36 x 12 x 72"	5	400	70	\$165	\$155
H-7115	36 x 18 x 72"				180	170
■H-7116	36 x 24 x 72"				195	185
H-7117	48 x 12 x 72"	5	300	88	195	185
■H-7118	48 x 18 x 72"				205	195
■H-7119	48 x 24 x 72"				235	225

■ SHIPS UNASSEMBLED VIA MOTOR FREIGHT

## 84" HEIGHT

MODEL NO.	DIMENSIONS W x D x H	NO. OF SHELVES	SHELF CAP. (LBS.)	WT. (LBS.)	PRICE EACH	
					1	3+
H-5520	36 x 12 x 84"	5	400	73	\$175	\$165
H-5186	36 x 18 x 84"				99	180
■H-5187	36 x 24 x 84"				114	195
H-5521	48 x 12 x 84"	5	300	91	205	195
■H-5188	48 x 18 x 84"				120	205
■H-5189	48 x 24 x 84"				145	235

■ SHIPS UNASSEMBLED VIA MOTOR FREIGHT

# MILK CRATES

## COLLAPSIBLE

Multipurpose. Holds folders, tools and other hard-to-carry items.

- Stores anywhere – Folds to 2¾" when not in use.
- Versatile, use for permanent or temporary storage. 30 lb. capacity.

## RIGID

Sturdy storage for trunk, closet, shop or shed.

- Strong high-density polyethylene. • Stackable. 40 lb. capacity.



## COLLAPSIBLE



SPECIFY COLOR: Gray, Black, Red or Blue

MODEL NO.	INSIDE DIM. L x W x H	CUBIC FT.	WT. (LBS.)	PRICE EACH (MIN. 3)		
				3	12	24+
S-10715	20 x 13 x 10"	1.5	4	\$46	\$45	\$44
S-15609	22 x 14 x 11"	2.0	5	56	54	53

## RIGID

SPECIFY COLOR: Black, Blue, Red or Green

MODEL NO.	INSIDE DIM. L x W x H	CUBIC FT.	WT. (LBS.)	PRICE EACH (MIN. 3)		
				3	12	24+
S-16317	12 x 12 x 10½"	0.9	3	\$12	\$11	\$10
S-19955	18 x 12 x 10½"	1.4	4	20	19	17



# FILE STORAGE KEEPBOX™

Long-term storage for your important documents.

- Provides protection in damp warehouses and basements.
- Attached interlocking lid. Molded handles. Stacks 4 high.
- Includes metal rails for hanging folders.



SPECIFY LID COLOR: Blue, Black or Green

MODEL NO.	OUTSIDE DIMENSIONS L x W x H	CAPACITY (LBS.)	SHIPPING WEIGHT	PRICE EACH (MIN. 3)		
				3	12	24+
S-19938	21.5 x 15.3 x 12.5"	35	6 lbs.	\$28	\$27	\$26



# WIDE SPAN STORAGE RACKS

Continued from page 473.



**FREE**

H-2215 Rubber Mallet with any \$200+ Wide Span Order Upon Request.

MODEL NO.	PRICE EACH
H-2215	\$8.50

## 84" HEIGHT

MODEL NO.	DIMENSIONS W x D x H	NO. OF SHELVES	SHELF SUPPORTS	SHELF CAP. (LBS.)	PARTICLE BOARD		WT. (LBS.)
					1	3+	
H-2499	36 x 12 x 84"	3	3	1,800	\$173	\$166	75
H-2209	36 x 18 x 84"			1,800	190	182	87
H-1891	36 x 24 x 84"			1,800	204	197	105
H-2500	48 x 12 x 84"	3	3	1,500	194	186	87
H-1535	48 x 18 x 84"			1,500	216	204	107
H-1060	48 x 24 x 84"			1,500	232	223	123
■H-1892	48 x 36 x 84"			1,500	276	263	169
■H-1893	48 x 48 x 84"			1,500	317	305	200
H-1536	60 x 18 x 84"	3	3	1,400	245	233	124
■H-1388	60 x 24 x 84"			1,400	262	252	151
■H-2210	60 x 36 x 84"			1,400	286	276	199
■H-2211	60 x 48 x 84"			1,400	343	327	238
H-1537	72 x 18 x 84"	3	6	1,200	293	282	146
■H-1061	72 x 24 x 84"			1,200	306	293	178
■H-1203	72 x 36 x 84"			1,200	363	350	222
■H-1389	72 x 48 x 84"			1,200	415	399	273
■H-1538	96 x 18 x 84"	3	9	1,000	350	336	183
■H-1390	96 x 24 x 84"			1,000	372	355	215
■H-1062	96 x 36 x 84"			1,000	432	413	282
■H-1204	96 x 48 x 84"			1,000	498	476	357

## WIRE DECKING

MODEL NO.	PRICE EACH		WT. (LBS.)
	1	3+	
H-3258	\$184	\$176	64
H-3259	201	195	75
H-3260	219	209	84
H-3261	206	200	73
H-3262	225	218	86
H-3263	246	235	98
H-3264	291	281	121
■H-3265	335	320	146
H-3266	255	246	98
H-3267	283	271	117
■H-3268	313	300	138
■H-3269	371	355	168
H-3270	314	303	113
H-3271	333	319	130
■H-3272	396	381	162
■H-3273	443	424	195
■H-3274	373	356	139
■H-3275	401	385	161
■H-3276	465	445	203
■H-3277	533	510	247

■ SHIPS UNASSEMBLED VIA MOTOR FREIGHT

## 96" HEIGHT

■H-2501	36 x 12 x 96"	3	3	1,800	\$179	\$170	78
■H-2212	36 x 18 x 96"			1,800	194	186	90
■H-1965	36 x 24 x 96"			1,800	212	202	108
■H-2502	48 x 12 x 96"	3	3	1,500	200	193	90
■H-1966	48 x 18 x 96"			1,500	220	210	110
■H-1894	48 x 24 x 96"			1,500	239	229	126
■H-1895	48 x 36 x 96"			1,500	283	273	172
■H-1967	48 x 48 x 96"			1,500	322	309	203
■H-1968	60 x 18 x 96"	3	3	1,400	249	239	127
■H-1896	60 x 24 x 96"			1,400	269	257	154
■H-2213	60 x 36 x 96"			1,400	299	286	202
■H-2214	60 x 48 x 96"			1,400	349	335	241
■H-1969	72 x 18 x 96"	3	6	1,200	299	286	149
■H-1897	72 x 24 x 96"			1,200	312	299	181
■H-1898	72 x 36 x 96"			1,200	372	355	225
■H-1899	72 x 48 x 96"			1,200	423	406	276
■H-1970	96 x 18 x 96"	3	9	1,000	355	342	186
■H-1900	96 x 24 x 96"			1,000	385	370	218
■H-1901	96 x 36 x 96"			1,000	438	420	285
■H-1902	96 x 48 x 96"			1,000	503	482	360

■H-3278	\$193	\$184	67
■H-3279	208	200	78
■H-3280	224	216	87
■H-3281	214	204	76
■H-3282	233	224	89
■H-3283	251	243	101
■H-3284	300	289	124
■H-3285	343	330	149
■H-3286	264	251	101
■H-3287	289	276	120
■H-3288	320	308	141
■H-3289	378	361	171
■H-3290	320	308	116
■H-3291	338	325	133
■H-3292	404	388	165
■H-3293	450	431	198
■H-3294	379	363	142
■H-3295	409	395	164
■H-3296	470	451	206
■H-3297	538	515	250

■ SHIPS UNASSEMBLED VIA MOTOR FREIGHT

## 120" HEIGHT

■H-2963	36 x 12 x 120"	3	3	1,800	\$212	\$203	85
■H-2964	36 x 18 x 120"			1,800	229	220	97
■H-2965	36 x 24 x 120"			1,800	247	236	115
■H-2966	48 x 12 x 120"	3	3	1,500	235	226	97
■H-2967	48 x 18 x 120"			1,500	253	245	117
■H-2968	48 x 24 x 120"			1,500	275	262	133
■H-2969	48 x 36 x 120"			1,500	315	303	179
■H-2970	48 x 48 x 120"			1,500	355	342	210
■H-2971	60 x 18 x 120"	3	3	1,400	286	276	134
■H-2972	60 x 24 x 120"			1,400	303	289	161
■H-2973	60 x 36 x 120"			1,400	332	319	209
■H-2974	60 x 48 x 120"			1,400	380	363	248
■H-2975	72 x 18 x 120"	3	6	1,200	337	323	156
■H-2976	72 x 24 x 120"			1,200	346	330	188
■H-2977	72 x 36 x 120"			1,200	402	385	232
■H-2978	72 x 48 x 120"			1,200	453	435	283
■H-2979	96 x 18 x 120"	3	9	1,000	393	378	193
■H-2980	96 x 24 x 120"			1,000	410	393	225
■H-2981	96 x 36 x 120"			1,000	472	452	292
■H-2982	96 x 48 x 120"			1,000	539	516	367

■H-3298	\$224	\$216	74
■H-3299	244	233	85
■H-3300	264	251	94
■H-3301	251	243	83
■H-3302	270	258	96
■H-3303	291	281	108
■H-3304	334	320	131
■H-3305	376	360	156
■H-3306	305	291	108
■H-3307	321	310	127
■H-3308	340	329	148
■H-3309	396	381	178
■H-3310	361	345	123
■H-3311	373	356	140
■H-3312	426	410	172
■H-3313	484	463	205
■H-3314	421	404	149
■H-3315	440	421	171
■H-3316	505	484	213
■H-3317	570	545	257

■ SHIPS UNASSEMBLED VIA MOTOR FREIGHT



# WIDE SPAN STORAGE RACKS

Store and unload heavy, bulky items with convenient four-way access to shelves.



- Quick, easy assembly. Shelves snap into place and adjust at 1½" increments.
- 3 shelves hold up to 1,800 lbs. each.
- 96" boards and decking ship in two pieces.

**Particle Board** – Smooth, solid 5/8" board eliminates item fall-through.

**Wire Decking** – Galvanized steel mesh. 2 x 4" openings prevent dust and dirt buildup, maximize fire sprinkler efficiency.



For Additional Shelves, see page 474.

## 60" HEIGHT

MODEL NO.	DIMENSIONS W x D x H	NO. OF SHELVES	SHELF SUPPORTS	SHELF CAP. (LBS.)	PARTICLE BOARD		WT. (LBS.)
					PRICE EACH		
					1	3+	
H-2495	36 x 12 x 60"	3	3	1,800	\$160	\$154	67
H-2188	36 x 18 x 60"			1,800	177	170	79
H-2189	36 x 24 x 60"			1,800	194	186	97
H-2496	48 x 12 x 60"	3	3	1,500	183	176	79
H-2190	48 x 18 x 60"			1,500	202	194	99
H-2191	48 x 24 x 60"			1,500	222	212	115
■H-2192	48 x 36 x 60"			1,500	263	253	161
■H-2193	48 x 48 x 60"			1,500	306	293	192
H-2194	60 x 18 x 60"			1,400	232	223	116
■H-2195	60 x 24 x 60"	3	3	1,400	250	242	143
■H-2196	60 x 36 x 60"			1,400	277	266	191
■H-2197	60 x 48 x 60"			1,400	330	317	230
H-2198	72 x 18 x 60"			1,200	282	272	138
■H-2199	72 x 24 x 60"	3	6	1,200	295	282	170
■H-2200	72 x 36 x 60"			1,200	353	339	214
■H-2201	72 x 48 x 60"			1,200	403	386	265
■H-2202	96 x 18 x 60"			1,000	339	325	175
■H-2203	96 x 24 x 60"	3	9	1,000	358	345	207
■H-2204	96 x 36 x 60"			1,000	420	403	274
■H-2205	96 x 48 x 60"			1,000	483	465	349

## WIRE DECKING

MODEL NO.	PRICE EACH		WT. (LBS.)
	1	3+	
	H-3218	\$171	
H-3219	188	180	67
H-3220	204	196	76
H-3221	194	185	64
H-3222	214	204	77
H-3223	233	224	89
H-3224	281	270	112
■H-3225	325	311	138
H-3226	244	233	90
H-3227	266	255	104
■H-3228	300	289	130
■H-3229	358	343	160
H-3230	299	288	105
H-3231	318	306	121
■H-3232	384	366	154
■H-3233	428	411	187
■H-3234	360	344	132
■H-3235	388	373	153
■H-3236	450	431	195
■H-3237	516	498	239

■ SHIPS UNASSEMBLED VIA MOTOR FREIGHT

## 72" HEIGHT

H-2497	36 x 12 x 72"	3	3	1,800	\$166	\$159	70
H-2206	36 x 18 x 72"			1,800	183	176	82
H-1888	36 x 24 x 72"			1,800	199	192	100
H-2498	48 x 12 x 72"	3	3	1,500	190	182	82
H-1523	48 x 18 x 72"			1,500	207	199	102
H-1524	48 x 24 x 72"			1,500	227	219	118
■H-1889	48 x 36 x 72"			1,500	272	259	164
■H-1890	48 x 48 x 72"			1,500	310	297	195
H-1525	60 x 18 x 72"			1,400	236	227	119
■H-1526	60 x 24 x 72"	3	3	1,400	257	247	146
■H-2207	60 x 36 x 72"			1,400	285	275	194
■H-2208	60 x 48 x 72"			1,400	339	325	233
H-1527	72 x 18 x 72"			1,200	286	276	141
■H-1528	72 x 24 x 72"	3	6	1,200	300	287	173
■H-1529	72 x 36 x 72"			1,200	358	345	217
■H-1530	72 x 48 x 72"			1,200	408	390	268
■H-1531	96 x 18 x 72"			1,000	345	329	178
■H-1532	96 x 24 x 72"	3	9	1,000	363	350	210
■H-1533	96 x 36 x 72"			1,000	426	409	277
■H-1534	96 x 48 x 72"			1,000	495	473	352

H-3238	\$178	\$171	58
H-3239	195	186	70
H-3240	211	203	79
H-3241	200	193	67
H-3242	219	209	80
H-3243	240	229	92
H-3244	288	275	115
■H-3245	331	316	141
H-3246	249	240	93
H-3247	275	264	111
■H-3248	306	294	133
■H-3249	363	348	163
H-3250	306	294	108
H-3251	325	311	124
■H-3252	389	375	157
■H-3253	434	419	190
■H-3254	365	353	135
■H-3255	394	378	156
■H-3256	456	440	198
■H-3257	526	505	242

■ SHIPS UNASSEMBLED VIA MOTOR FREIGHT

# TWO-SHELF WIDE SPAN STORAGE RACKS



Store heavy power tools or create a workstation.

Industrial storage at a comfortable working height. Convenient four-way access.

- Quick, easy assembly. Shelves snap into place and adjust at 1½" increments.

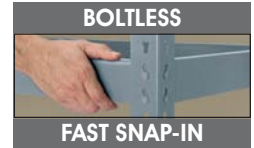

36" HEIGHT					PARTICLE BOARD		
MODEL NO.	DIMENSIONS W x D x H	SHELF CAP. (LBS.)	NO. OF SHELVES	SHELF SUPPORTS	PRICE EACH		WT. (LBS.)
					1	3+	
H-4270	36 x 12 x 36"	1,800			\$110	\$105	48
H-4271	36 x 18 x 36"	1,800	2	2	115	110	54
H-4272	36 x 24 x 36"	1,800			125	120	68
H-4273	48 x 12 x 36"	1,500			120	115	56
H-4274	48 x 18 x 36"	1,500	2	2	130	125	71
H-4275	48 x 24 x 36"	1,500			140	135	83
H-4813	60 x 18 x 36"	1,400	2	2	145	140	84
H-4814	60 x 24 x 36"	1,400			155	150	99

# WIDE SPAN ADDITIONAL SHELVES



Add extra shelves to Wide Span Storage Racks.

- Quick, easy assembly. Shelves snap into place and adjust at 1½" increments.
- Particle Board – Smooth, solid 5/8" board eliminates item fall-through.
- Wire Decking – 2 x 4" openings prevent dust and dirt buildup, maximize fire sprinkler efficiency.
- Includes shelf supports.

MODEL NO.	DIMENSIONS W x D	SHELF CAP. (LBS.)	PARTICLE BOARD			MODEL NO.	WIRE DECKING		
			PRICE EACH		WT. (LBS.)		PRICE EACH		WT. (LBS.)
			1	3+			1	3+	
H-2495-ADD	36 x 12"	1,800	\$46	\$43	17	H-3218-ADD	\$49	\$46	14
H-2188-ADD	36 x 18"	1,800	51	49	21	H-3219-ADD	54	50	17
H-2189-ADD	36 x 24"	1,800	59	54	27	H-3220-ADD	63	58	21
H-2496-ADD	48 x 12"	1,500	56	51	22	H-3221-ADD	59	54	16
H-2190-ADD	48 x 18"	1,500	64	59	27	H-3222-ADD	68	63	21
H-2191-ADD	48 x 24"	1,500	70	66	33	H-3223-ADD	75	69	25
H-2192-ADD	48 x 36"	1,500	92	84	46	H-3224-ADD	95	89	34
■H-2193-ADD	48 x 48"	1,500	117	106	59	■H-3225-ADD	121	113	43
H-2194-ADD	60 x 18"	1,400	66	60	33	H-3226-ADD	71	65	25
H-2195-ADD	60 x 24"	1,400	84	77	41	H-3227-ADD	89	83	30
■H-2196-ADD	60 x 36"	1,400	93	86	56	■H-3228-ADD	96	90	38
■H-2197-ADD	60 x 48"	1,400	117	106	70	■H-3229-ADD	120	111	47
H-2198-ADD	72 x 18"	1,200	90	83	40	H-3230-ADD	95	89	30
H-2199-ADD	72 x 24"	1,200	99	92	48	H-3231-ADD	106	96	35
■H-2200-ADD	72 x 36"	1,200	122	112	67	■H-3232-ADD	129	118	47
■H-2201-ADD	72 x 48"	1,200	144	132	84	■H-3233-ADD	150	138	58
■H-2202-ADD	96 x 18"	1,000	120	109	52	H-3234-ADD	129	118	38
■H-2203-ADD	96 x 24"	1,000	126	117	67	H-3235-ADD	134	124	46
H-2204-ADD	96 x 36"	1,000	149	136	88	H-3236-ADD	160	146	62
■H-2205-ADD	96 x 48"	1,000	186	172	109	■H-3237-ADD	198	184	77

■ SHIPS VIA MOTOR FREIGHT



# LAMINATE WIDE SPAN RACKS

Stock your janitorial or breakroom supplies.

- Thick 5/8" laminate boards resist leaking liquids and cleaning solutions. Wipes down easily.
- Quick, easy assembly. Shelves snap into place and adjust at 1½" increments.



72" HEIGHT					LAMINATE BOARD		
MODEL NO.	DIMENSIONS W x D x H	SHELF CAP. (LBS.)	NO. OF SHELVES	SHELF SUPPORTS	PRICE EACH		WT. (LBS.)
					1	3+	
H-8598	48 x 24 x 72"	1,500	3	3	\$235	\$225	128
■H-8599	60 x 24 x 72"	1,400			270	260	151
■H-8600	72 x 24 x 72"	1,200	3	6	315	305	179
■H-8601	96 x 24 x 72"	1,000		9	390	380	228

Additional Shelves, see [uline.com](http://uline.com)

■ SHIPS UNASSEMBLED VIA MOTOR FREIGHT



# HEAVY-DUTY STEEL SHELVING

Highest capacity storage for motors, dies and heavy machine parts. Up to 2 tons per shelf!

- **Boltless assembly.** Shelves snap into place and adjust at 1½" increments.
- Four-way access for easy loading and unloading.
- 14-gauge steel posts; 16-gauge steel shelves.
- Tough, powder-coat finish.
- Made in the USA.
- Additional sizes, see [uline.com](http://uline.com)

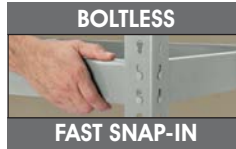

## ADDITIONAL SHELVES

- Add extra shelves to maximize storage space.
- Boltless design for easy assembly.

### 72" HEIGHT

MODEL NO.	DIMENSIONS W x D x H	NO. OF SHELVES	SHELF SUPPORTS	SHELF CAP. (LBS.)	PRICE EACH		WT. (LBS.)
					1	2+	
H-3911	36 x 18 x 72"	5	5	4,000	\$465	\$450	143
H-4857	36 x 24 x 72"				560	540	172
H-3912	48 x 18 x 72"				565	545	178
H-3913	48 x 24 x 72"	5	5	3,250	655	635	212
H-4862	60 x 24 x 72"				795	770	263
H-5444	60 x 36 x 72"				985	955	327
H-5445	72 x 18 x 72"	5	10	2,750	815	790	265
H-3914	72 x 24 x 72"				890	860	295
H-3915	72 x 36 x 72"				1,160	1,120	337
H-7432	96 x 24 x 72"	5	15	2,600	1,445	1,400	472

### ADDITIONAL SHELVES

MODEL NO.	PRICE EACH		WT. (LBS.)
	1	2+	
H-3911-ADD	\$95	\$92	25
H-4857-ADD	111	107	34
H-3912-ADD	114	111	32
H-3913-ADD	132	127	40
H-4862-ADD	178	173	52
H-5444-ADD	218	213	67
H-5445-ADD	185	179	53
H-3914-ADD	195	191	57
H-3915-ADD	271	262	79
H-7432-ADD	326	318	95

### 84" HEIGHT

H-3120	36 x 18 x 84"	5	5	4,000	\$475	\$460	148
H-4858	36 x 24 x 84"				570	550	177
H-3121	48 x 18 x 84"				575	555	183
H-3122	48 x 24 x 84"	5	5	3,250	665	645	217
H-4863	60 x 24 x 84"				805	780	268
H-5446	60 x 36 x 84"				995	965	332
H-5447	72 x 18 x 84"	5	10	2,750	825	800	270
H-3123	72 x 24 x 84"				900	870	300
H-3916	72 x 36 x 84"				1,170	1,130	342
H-7433	96 x 24 x 84"	5	15	2,600	1,455	1,410	477

### ADDITIONAL SHELVES

H-3911-ADD	\$95	\$92	25
H-4857-ADD	111	107	34
H-3912-ADD	114	111	32
H-3913-ADD	132	127	40
H-4862-ADD	178	173	52
H-5444-ADD	218	213	67
H-5445-ADD	185	179	53
H-3914-ADD	195	191	57
H-3915-ADD	271	262	79
H-7432-ADD	326	318	95

### 96" HEIGHT

H-4859	36 x 24 x 96"	5	5	4,000	\$580	\$560	182
H-4260	48 x 18 x 96"				585	565	188
H-4261	48 x 24 x 96"	5	5	3,250	675	655	223
H-4864	60 x 24 x 96"				815	790	272
H-5448	60 x 36 x 96"				1,005	975	335
H-5449	72 x 18 x 96"	5	10	2,750	835	810	275
H-4262	72 x 24 x 96"				910	880	305
H-4263	72 x 36 x 96"				1,180	1,140	347
H-7434	96 x 24 x 96"	5	15	2,600	1,465	1,420	480
H-10486	96 x 36 x 96"				1,800	1,750	624

### ADDITIONAL SHELVES

H-4857-ADD	\$111	\$107	34
H-3912-ADD	114	111	32
H-3913-ADD	132	127	40
H-4862-ADD	178	173	52
H-5444-ADD	218	213	67
H-5445-ADD	185	179	53
H-3914-ADD	195	191	57
H-3915-ADD	271	262	79
H-7432-ADD	326	318	95
H-10486-ADD	425	415	128

SHIPS UNASSEMBLED VIA MOTOR FREIGHT

## BULK RACK ADDITIONAL SHELVES

Add particle board or wire decking extra shelves to Bulk Storage Racks.

- **Boltless assembly.** Shelves snap into place and adjust at 2" increments.
- Additional shelf sizes, see [uline.com](http://uline.com)

MODEL NO.	DIM. W x D	SHELF CAP. (LBS.)	PARTICLE BOARD			MODEL NO.	WIRE DECKING		
			PRICE EACH		WT. (LBS.)		PRICE EACH		WT. (LBS.)
			1	2+			1	2+	
H-2873-ADD	72 x 24"	2,750	\$95	\$89	55	H-4319-ADD	\$105	\$103	42
H-3346-ADD	72 x 36"		110	105	73	H-4320-ADD	124	121	53
H-2874-ADD	72 x 48"		126	122	89	H-4321-ADD	141	139	64
H-2875-ADD	96 x 24"	2,150	121	116	74	H-4322-ADD	136	133	53
H-3347-ADD	96 x 36"		137	134	93	H-4323-ADD	156	154	68
H-2876-ADD	96 x 48"		164	162	113	H-4324-ADD	186	181	83



**Particle Board** – Smooth, solid 5/8" board eliminates item fall-through.

**Wire Decking** – 2 x 4" openings prevent dust and dirt buildup.

SHIPS VIA MOTOR FREIGHT

## BULK STORAGE RACK ADD-ON UNITS

Double your existing storage space by connecting additional shelving.

- Add-On Unit connects to existing starter unit to extend rack. Easy to attach.
- Includes 3 shelves, 12 shelf supports and one welded steel upright.
- Additional sizes, see [uline.com](http://uline.com)



MODEL NO.	DIMENSIONS W x D x H	NO. OF SHELVES	SHELF SUPPORTS	SHELF CAP. (LBS.)	PARTICLE BOARD			MODEL NO.	WIRE DECKING		
					PRICE EACH		WT. (LBS.)		PRICE EACH		WT. (LBS.)
					1	2+			1	2+	
H-3769	72 x 24 x 72"	3	12	2,750	\$363	\$347	189	H-4392	\$386	\$370	146
H-3770	72 x 36 x 72"				427	411	234	H-4393	456	436	180
H-3771	72 x 48 x 72"				490	467	285	H-4394	521	496	204
H-3772	96 x 24 x 72"	3	12	2,150	443	422	230	H-4395	471	450	177
H-3773	96 x 36 x 72"				504	482	295	H-4396	539	514	217
H-3774	96 x 48 x 72"				584	559	367	H-4397	621	595	257
H-4386	72 x 24 x 96"	3	12	2,750	395	375	196	H-4398	419	399	151
H-4387	72 x 36 x 96"				464	443	243	H-4399	494	471	187
H-4388	72 x 48 x 96"				526	501	294	H-4400	560	536	215
H-4389	96 x 24 x 96"	3	12	2,150	464	443	237	H-4401	494	471	182
H-4390	96 x 36 x 96"				529	504	304	H-4402	564	539	226
H-4391	96 x 48 x 96"				618	592	377	H-4403	659	631	267

SHIPS UNASSEMBLED VIA MOTOR FREIGHT

## STEEL BULK STORAGE RACKS

Store heavy dies, tools and motors. Steel shelves will not warp.

- 22-gauge **ribbed steel decking** withstands concentrated weight.
- **Boltless assembly.** Shelves adjust at 2" increments.
- Welded steel uprights with cross braces for maximum strength. Heavy-duty 14-gauge steel.
- Welded footplates for floor mounting.

MODEL NO.	DIMENSIONS W x D x H	NO. OF SHELVES	SHELF SUPPORTS	SHELF CAP. (LBS.)	STEEL DECKING		
					PRICE EACH		WT. (LBS.)
					1	2+	
H-8563	72 x 24 x 72"	3	12	2,750	\$585	\$565	178
H-8564	72 x 36 x 72"				675	650	216
H-8565	96 x 24 x 72"	3	12	2,150	685	660	217
H-8566	96 x 36 x 72"				780	755	261

SHIPS UNASSEMBLED VIA MOTOR FREIGHT



# BULK STORAGE RACKS

Store your heaviest, extra-wide or bulky items.  
Up to 3,000 lbs. per shelf.

- **Boltless assembly.** Shelves snap into place and adjust at 2" increments.
- **Welded steel uprights with cross braces** for maximum strength. Heavy-duty 14-gauge steel.
- Includes up to 4 supports per shelf.
- 96" boards and decking ship in two pieces.
- Welded footplates for floor mounting.

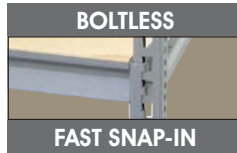

**Wire Decking** – Galvanized steel mesh. 2 x 4" openings prevent dust and dirt buildup, maximize fire sprinkler efficiency.



**Particle Board** – Smooth, solid 5/8" thick board eliminates item fall-through.

## 3 SHELF STARTER UNITS

MODEL NO.	DIMENSIONS W x D x H	NO. OF SHELVES	SHELF SUPPORTS	SHELF CAP. (LBS.)	PARTICLE BOARD		WT. (LBS.)
					1	2+	
H-5393	48 x 24 x 72"	3	6	3,000	\$341	\$327	156
H-5394	48 x 36 x 72"				379	366	189
H-5395	60 x 24 x 72"				388	374	179
H-2873	72 x 24 x 72"	3	12	2,750	426	411	209
H-3346	72 x 36 x 72"				492	474	255
H-2874	72 x 48 x 72"				552	530	308
H-2875	96 x 24 x 72"	3	12	2,150	504	485	250
H-3347	96 x 36 x 72"				569	547	316
H-2876	96 x 48 x 72"				648	623	390
H-5396	48 x 24 x 96"	3	6	3,000	379	366	170
H-5397	48 x 36 x 96"				433	416	207
H-5398	60 x 24 x 96"				433	416	193
H-2877	72 x 24 x 96"	3	12	2,750	474	453	223
H-3348	72 x 36 x 96"				544	521	273
H-2878	72 x 48 x 96"				604	581	327
H-2879	96 x 24 x 96"	3	12	2,150	544	521	264
H-3349	96 x 36 x 96"				608	584	334
H-2880	96 x 48 x 96"				697	670	410
H-5399	48 x 24 x 120"	3	6	3,000	422	406	180
H-5400	48 x 36 x 120"				466	448	217
H-5401	60 x 24 x 120"				469	451	203
H-4310	72 x 24 x 120"	3	12	2,750	521	500	237
H-4311	72 x 36 x 120"				595	570	285
H-4312	72 x 48 x 120"				644	618	346
H-4313	96 x 24 x 120"	3	12	2,150	597	574	278
H-4314	96 x 36 x 120"				659	632	357
H-4315	96 x 48 x 120"				748	721	430

MODEL NO.	WIRE DECKING		WT. (LBS.)
	1	2+	
H-5414	\$365	\$350	122
H-5415	405	390	141
H-5416	414	399	138
H-4319	455	436	160
H-4320	524	505	195
H-4321	588	565	230
H-4322	539	518	196
H-4323	606	583	237
H-4324	690	663	280
H-5417	405	390	136
H-5418	464	445	159
H-5419	464	445	152
H-4325	505	485	175
H-4326	579	555	213
H-4327	644	619	249
H-4328	579	555	210
H-4329	649	621	255
H-4330	743	716	300
H-5420	451	434	146
H-5421	496	479	169
H-5422	503	483	162
H-4331	555	534	189
H-4332	633	609	225
H-4333	688	660	257
H-4334	635	611	224
H-4335	703	674	266
H-4336	799	769	310

SHIPS UNASSEMBLED VIA MOTOR FREIGHT



# WIRE DECKING

# FOR PALLET RACKING



Waterfall edge provides extra strength and a secure fit.

- Drops easily into place. No tools required.
- Galvanized 2½ x 4" mesh maximizes sprinkler efficiency.
- Resists rust and corrosion. • Includes 3 support channels.



Sold in multiples of 2

MODEL NO.	DIMENSIONS W x D	FOR RACKS	LOAD CAP. (LBS.)	WT. (LBS.)	PRICE PER DECK		SKID LOT	
					2	12+	QTY./SKID	PRICE EACH
H-7663	46 x 36"	96 or 144" Wide	2,500	18	\$43	\$39	44	\$35
H-5724	46 x 42"			20	45	41		37
H-5725	46 x 48"			23	53	49		45
H-7664	52 x 36"	108" Wide	2,500	20	47	43	44	39
H-6231	52 x 42"			22	51	47		43
H-6232	52 x 48"			27	60	56		52
H-7665	58 x 36"	120" Wide	2,500	21	53	49	44	44
H-6233	58 x 42"			23	57	53		48
H-6234	58 x 48"			29	65	61		56

SHIPS VIA MOTOR FREIGHT

# ADDITIONAL BEAMS

# FOR PALLET RACKING



Easily add extra levels to your Pallet Racks.

- Beams lock into place and adjust in 2" increments.
- 16-gauge steel beams hold 5,000 lbs. per level.
- Includes 2 beams per level.



MODEL NO.	WIDTH	NO. OF LEVELS	BEAM HEIGHT	BEAM CAP. (LBS./PAIR)	WT. (LBS.)	PRICE PER LEVEL	
						1	4+
H-5953	96"	1	4"	5,000	48	\$150	\$145
H-6235	108"		4½"		58	170	165
H-6236	120"		5"		68	195	190
H-6804	144"		6"		94	260	255

SHIPS VIA MOTOR FREIGHT

# PALLET RACK ACCESSORIES

## CROSS BARS

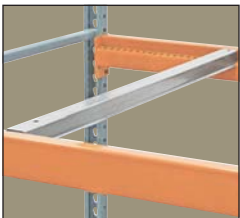

Galvanized steel. Extra support for pallets. Requires slotted beams.

MODEL NO.	FOR RACKS	CAP. (LBS.)	PRICE EACH (MIN. 4)	
			4	12+
H-7666	36" Deep	1,000	\$13	\$12
H-5726	42" Deep	1,000	15	14
H-5727	48" Deep	750	17	16

## DIVIDERS

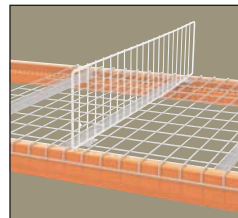

Keep items organized. Galvanized steel mesh clips on to wire decking.

MODEL NO.	SIZE D x H	PRICE EACH (MIN. 4)	
		4	12+
H-7667	36 x 10"	\$19	\$18
H-5868	42 x 10"	21	20
H-5869	48 x 10"	23	22

# PALLET RACKS

Continued from page 479.

## 2 SHELF STARTER UNITS

144" HEIGHT

MODEL NO.	DIMENSIONS W x D x H	NO. OF LEVELS	BEAM HEIGHT	BEAM CAP. (LBS./PAIR)	PRICE EACH			WT. (LBS.)
					1	3	6+	
H-6195	96 x 42 x 144"	2	4"	5,000	\$695	\$685	\$675	242
H-6196	96 x 48 x 144"				715	705	695	248
H-6197	108 x 42 x 144"	2	4½"	5,000	745	735	725	265
H-6198	108 x 48 x 144"				770	760	750	271
H-6199	120 x 42 x 144"	2	5"	5,000	800	790	780	285
H-6200	120 x 48 x 144"				815	805	795	291
H-6809	144 x 42 x 144"	2	6"	5,000	925	915	905	324
H-6810	144 x 48 x 144"				945	935	925	328

SHIPS UNASSEMBLED VIA MOTOR FREIGHT

## 2 SHELF ADD-ON UNITS

144" HEIGHT

MODEL NO.	PRICE EACH			WT. (LBS.)
	1	3	6+	
H-6195-ADD	\$495	\$485	\$475	169
H-6196-ADD	500	490	480	172
H-6197-ADD	545	535	525	192
H-6198-ADD	550	540	530	195
H-6199-ADD	590	580	570	212
H-6200-ADD	600	590	580	215
H-6809-ADD	715	705	695	255
H-6810-ADD	720	710	700	257

SHIPS UNASSEMBLED VIA MOTOR FREIGHT

# PALLET RACKS



Maximize warehouse space! High-capacity storage for your heaviest pallet loads.

## STARTER UNITS

- Provide easy forklift access to palletized boxes, crates and containers.
- Boltless assembly. Beams lock into place and adjust in 2" increments.
- Welded 14-gauge steel frame. 16-gauge steel beams.
- Includes 2 upright frames and 4 beams.

## ADD-ON UNITS

- Extend racking to increase storage space horizontally.
- Includes 1 upright frame and 4 beams.

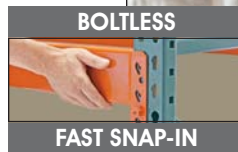

### 2 SHELF STARTER UNITS

96" HEIGHT

MODEL NO.	DIMENSIONS W x D x H	NO. OF LEVELS	BEAM HEIGHT	BEAM CAP. (LBS./PAIR)	PRICE EACH			WT. (LBS.)
					1	3	6+	
H-7461	96 x 36 x 96"	2	4"	5,000	\$545	\$535	\$525	186
H-5715	96 x 42 x 96"				560	550	540	190
H-5716	96 x 48 x 96"				580	570	560	194
H-7462	108 x 36 x 96"	2	4½"	5,000	600	590	580	209
H-6187	108 x 42 x 96"				615	605	595	213
H-6188	108 x 48 x 96"				635	625	615	217
H-7463	120 x 36 x 96"	2	5"	5,000	640	630	620	229
H-6189	120 x 42 x 96"				670	660	650	233
H-6190	120 x 48 x 96"				685	675	665	237
H-7464	144 x 36 x 96"	2	6"	5,000	770	760	750	276
H-6805	144 x 42 x 96"				790	780	770	280
H-6806	144 x 48 x 96"				800	790	780	284

### 2 SHELF ADD-ON UNITS

96" HEIGHT

MODEL NO.	PRICE EACH			WT. (LBS.)
	1	3	6+	
H-7461-ADD	\$415	\$405	\$395	142
H-5715-ADD	425	415	405	144
H-5716-ADD	430	420	410	146
H-7462-ADD	465	455	445	164
H-6187-ADD	475	465	455	166
H-6188-ADD	485	475	465	168
H-7463-ADD	510	500	490	184
H-6189-ADD	525	515	505	186
H-6190-ADD	535	525	515	188
H-7464-ADD	635	625	615	231
H-6805-ADD	640	630	620	233
H-6806-ADD	655	645	635	235

120" HEIGHT

MODEL NO.	DIMENSIONS W x D x H	NO. OF LEVELS	BEAM HEIGHT	BEAM CAP. (LBS./PAIR)	PRICE EACH			WT. (LBS.)
					1	3	6+	
H-7465	96 x 36 x 120"	2	4"	5,000	\$610	\$600	\$590	202
H-5717	96 x 42 x 120"				630	620	610	206
H-5718	96 x 48 x 120"				650	640	630	212
H-7466	108 x 36 x 120"	2	4½"	5,000	665	655	645	225
H-6191	108 x 42 x 120"				685	675	665	229
H-6192	108 x 48 x 120"				705	695	685	235
H-7467	120 x 36 x 120"	2	5"	5,000	710	700	690	245
H-6193	120 x 42 x 120"				735	725	715	249
H-6194	120 x 48 x 120"				760	750	740	255
H-7468	144 x 36 x 120"	2	6"	5,000	840	830	820	292
H-6807	144 x 42 x 120"				855	845	835	296
H-6808	144 x 48 x 120"				875	865	855	302

120" HEIGHT

MODEL NO.	PRICE EACH			WT. (LBS.)
	1	3	6+	
H-7465-ADD	\$445	\$435	\$425	149
H-5717-ADD	455	445	435	151
H-5718-ADD	465	455	445	154
H-7466-ADD	500	490	480	172
H-6191-ADD	510	500	490	174
H-6192-ADD	520	510	500	177
H-7467-ADD	550	540	530	192
H-6193-ADD	560	550	540	194
H-6194-ADD	575	565	555	197
H-7468-ADD	670	660	650	240
H-6807-ADD	685	675	665	242
H-6808-ADD	690	680	670	244

SHIPS UNASSEMBLED VIA MOTOR FREIGHT

SHIPS UNASSEMBLED VIA MOTOR FREIGHT





## PALLET RACK NETTING

Strong, nylon mesh with rope edge prevents items from falling off rack.

- Keeps workers and products safe from injury and damage.
- Attaches easily to uprights with included cable ties. No tools required.

Meets NFPA and OSHA Standards

MODEL NO.	FOR RACK W x H	LOAD RATING (LBS.)	SUGGESTED USE	MESH SIZE	PRICE EACH		WT. (LBS.)
					1	3+	
H-3917	96 x 48"	1,250	Peanuts, Foam	1 3/4 x 1 3/4"	\$100	\$95	3
H-3918	96 x 96"				165	155	4
H-3919	96 x 96"	2,500	Drums, Paper Rolls	4 x 4"	225	215	5
H-3920	96 x 120"				265	255	6
H-10686	96 x 144"				340	330	7

## PALLET RACK FLUE GUARD



Prevent pallet push-through to maintain proper flue space.

- Maximize fire sprinkler efficiency and comply with local fire codes.
- Durable, all-welded steel construction. Powder-coat finish.
- Compatible with wire decking. Mounting hardware included.

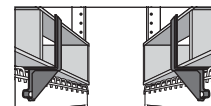

← FLUE SPACE →

Meets IBC 2012 and NFPA 13 Standards

MODEL NO.	DESCRIPTION	OFFSET SPACE	QTY./CTN.	PRICE PER CARTON	
				1	8+
H-9985	Flue Guard	3"	2	\$60	\$55

## 24" DEEP PALLET RACK ACCESSORIES



### CROSS BARS

Galvanized steel. Extra support for pallets. Requires slotted beams.

MODEL NO.	FOR RACKS	CAP. (LBS.)	PRICE EACH (MIN. 4)	
			4	12+
H-8589	24" Deep	1,000	\$10	\$9

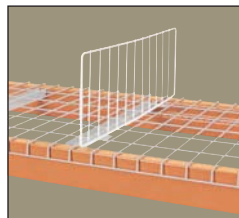

### DIVIDERS

Keep items organized. Galvanized steel mesh clips on to wire decking.

MODEL NO.	SIZE D x H	PRICE EACH (MIN. 4)	
		4	12+
H-8666	24 x 10"	\$17	\$16

## PALLET RACK ENCLOSURES



Prevent theft, control access and safely store inventory.

- 16-gauge steel frame. 8-gauge wire mesh panels with 2" square openings.

**Doors** – Swing open a full 180° for easy access to inventory. Padlockable.

**Back Panels** – Extend 1" or 6" beyond rack for pallet overhang.

**Side Panels** – Complete the enclosure on both sides. Mounts flush to uprights.

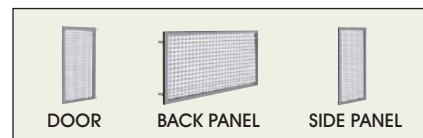

SHIPS VIA MOTOR FREIGHT

MODEL NO.	DESCRIPTION	FOR RACK W x H	DIMENSIONS W x H	QTY./CTN.	PRICE PER CARTON		WT. (LBS.)
					1	3+	
H-9889	Doors	96 x 96"	48 x 96"	2	\$785	\$765	120
H-9890	Back Panels	96 x 96"	96 x 48"	2	715	695	119
H-9891	Side Panels	42 x 96"	35 x 96"	2	385	375	93
H-9892		48 x 96"	41 x 96"		410	400	104



# 24" DEEP PALLET RACKS

A real space-saver! Narrow, 24" deep racking provides efficient storage for multiple SKUs – from labels and poly bags to parts.

## STARTER UNITS

- Boltless assembly. Beams lock into place and adjust in 2" increments.
- Welded 14-gauge steel frame. 16-gauge steel beams.
- Includes 2 upright frames and 4 beams.

## ADD-ON UNITS

- Extend racking to increase storage space horizontally.
- Includes 1 upright frame and 4 beams.

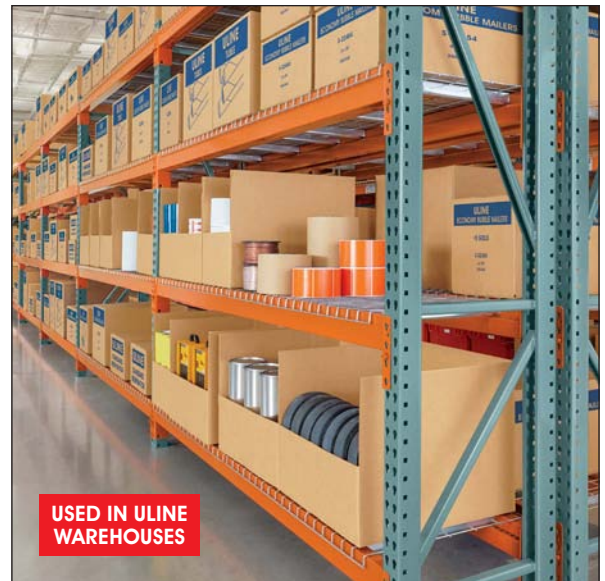

### 2 SHELF STARTER UNITS

96" HEIGHT

MODEL NO.	DIMENSIONS W x D x H	NO. OF LEVELS	BEAM HEIGHT	BEAM CAP. (LBS./PAIR)	PRICE EACH			WT. (LBS.)
					1	3	6+	
H-8610	48 x 24 x 96"	2	2¾"	5,000	\$365	\$355	\$345	126
H-8611	96 x 24 x 96"		4"		505	495	485	178
H-8612	108 x 24 x 96"		4½"		550	540	530	202
H-8613	120 x 24 x 96"	2	5"	5,000	605	595	585	222
H-8614	144 x 24 x 96"		6"		720	710	700	270

### 2 SHELF ADD-ON UNITS

96" HEIGHT

MODEL NO.	PRICE EACH			WT. (LBS.)
	1	3	6+	
H-8610-ADD	\$255	\$245	\$235	86
H-8611-ADD	390	380	370	137
H-8612-ADD	445	435	425	161
H-8613-ADD	495	485	475	181
H-8614-ADD	615	605	595	229

120" HEIGHT

H-9249	48 x 24 x 120"	2	2¾"	5,000	\$430	\$420	\$410	151
H-9250	96 x 24 x 120"		4"		570	560	550	202
H-9251	108 x 24 x 120"		4½"		625	615	605	226
H-9252	120 x 24 x 120"	2	5"	5,000	670	660	650	246
H-9253	144 x 24 x 120"		6"		795	785	775	294

120" HEIGHT

H-9249-ADD	\$285	\$275	\$265	98
H-9250-ADD	425	415	405	149
H-9251-ADD	475	465	455	173
H-9252-ADD	530	520	510	193
H-9253-ADD	650	640	630	241

144" HEIGHT

H-9254	48 x 24 x 144"	2	2¾"	5,000	\$500	\$490	\$480	176
H-9255	96 x 24 x 144"		4"		635	625	615	227
H-9256	108 x 24 x 144"		4½"		690	680	670	251
H-9257	120 x 24 x 144"	2	5"	5,000	740	730	720	271
H-9258	144 x 24 x 144"		6"		865	855	845	319

144" HEIGHT

H-9254-ADD	\$320	\$310	\$300	110
H-9255-ADD	455	445	435	162
H-9256-ADD	510	500	490	186
H-9257-ADD	560	550	540	206
H-9258-ADD	685	675	665	254

SHIPS UNASSEMBLED VIA MOTOR FREIGHT

SHIPS UNASSEMBLED VIA MOTOR FREIGHT

## ADDITIONAL BEAMS

Add extra levels to your warehouse Pallet Racks.

- 16-gauge steel construction.
- Includes 2 beams per level.



MODEL NO.	WIDTH	NO. OF LEVELS	BEAM HEIGHT	BEAM CAP. (LBS./PAIR)	PRICE/LEVEL		WT. (LBS.)
					1	4+	
H-8617	48"	1	2¾"	5,000	\$70	\$65	23
H-5953	96"		4"		150	145	48
H-6235	108"		4½"		170	165	58
H-6236	120"		5"		195	190	68
H-6804	144"		6"		260	255	94

SHIPS VIA MOTOR FREIGHT

## WIRE DECKING

Drops into place. Waterfall edge provides a secure fit.

- 2½ x 4" galvanized steel mesh.
- Includes 3 support channels.

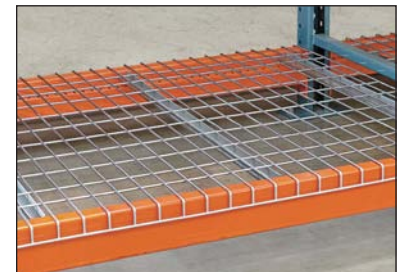

MODEL NO.	DIM. W x D	FOR RACKS	LOAD CAP. (LBS.)	WT. (LBS.)	PRICE/DECK		SKID LOT	
					2	12+	QTY./SKID	PRICE EACH
H-8618	46 x 24"	48, 96 or 144" Wide	2,500	11	\$39	\$35	44	\$31
H-8619	52 x 24"	108" Wide		12	43	39		
H-8620	58 x 24"	120" Wide		13	48	44		

Sold in multiples of 2

SHIPS VIA MOTOR FREIGHT



# HEAVY-DUTY PALLET RACKS New

Highest capacity storage for bulky machinery, large IBC tanks and your heaviest pallets.

## STARTER UNITS

*Interlake*

- Built tough for machine shops, manufacturing plants and industrial facilities.
- **Boltless assembly.** Beams lock into place and adjust in 2" increments.
- Welded 14-gauge steel frame. 16-gauge steel beams.
- Includes 2 upright frames and 4 beams.

## ADD-ON UNITS

- Extend racking to increase storage space horizontally.
- Includes 1 upright frame and 4 beams.



### 2 SHELF STARTER UNITS

#### 96" HEIGHT

MODEL NO.	DIMENSIONS W x D x H	NO. OF LEVELS	BEAM HEIGHT	BEAM CAP. (LBS./PAIR)	PRICE EACH			WT. (LBS.)
					1	3	6+	
H-10504	96 x 42 x 96"	2	5"	6,800	\$630	\$620	\$610	203
H-10505	96 x 48 x 96"				650	640	630	207
H-10506	144 x 42 x 96"	2	6½"	7,000	870	860	850	292
H-10507	144 x 48 x 96"				890	880	870	296

### 2 SHELF ADD-ON UNITS

#### 96" HEIGHT

MODEL NO.	PRICE EACH			WT. (LBS.)
	1	3	6+	
H-10504-ADD	\$480	\$470	\$460	157
H-10505-ADD	490	480	470	159
H-10506-ADD	705	695	685	245
H-10507-ADD	715	705	695	247

#### 120" HEIGHT

H-10508	96 x 42 x 120"	2	5"	6,800	\$700	\$690	\$680	219
H-10509	96 x 48 x 120"				720	710	700	225
H-10510	144 x 42 x 120"	2	6½"	7,000	940	930	920	308
H-10511	144 x 48 x 120"				960	950	940	314

#### 120" HEIGHT

H-10508-ADD	\$520	\$510	\$500	164
H-10509-ADD	530	520	510	167
H-10510-ADD	755	745	735	254
H-10511-ADD	765	755	745	256

#### 144" HEIGHT

H-10512	96 x 42 x 144"	2	5"	6,800	\$770	\$760	\$750	255
H-10513	96 x 48 x 144"				790	780	770	261
H-10514	144 x 42 x 144"	2	6½"	7,000	1,020	1,010	1,000	336
H-10515	144 x 48 x 144"				1,040	1,030	1,020	340

#### 144" HEIGHT

H-10512-ADD	\$560	\$550	\$540	182
H-10513-ADD	570	560	550	185
H-10514-ADD	785	775	765	267
H-10515-ADD	795	785	775	269

SHIPS UNASSEMBLED VIA MOTOR FREIGHT

SHIPS UNASSEMBLED VIA MOTOR FREIGHT

## WIRE DECKING

Super strong design. Waterfall edge drops into place.

- 2½ x 4" galvanized steel mesh.
- Includes 4 support channels.

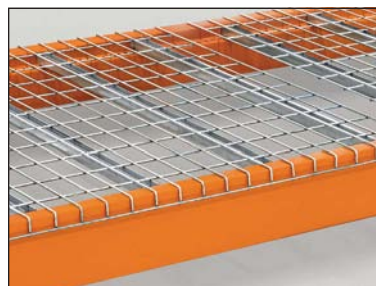

Sold in multiples of 2

MODEL NO.	DIM. W x D	FOR RACKS	LOAD CAP. (LBS.)	WT. (LBS.)	PRICE/DECK		SKID LOT	
					2	12+	QTY./SKID	PRICE EACH
H-10518	46 x 42"	96 or 144" Wide	3,500	25	\$70	\$65	44	\$59
H-10519	46 x 48"			32	80	75		

SHIPS VIA MOTOR FREIGHT

## ADDITIONAL BEAMS

Add extra levels to your Heavy-Duty Pallet Racks.

- 16-gauge steel construction.
- Includes 2 beams per level.



MODEL NO.	WIDTH	NO. OF LEVELS	BEAM HEIGHT	BEAM CAP. (LBS./PAIR)	PRICE PER LEVEL		WT. (LBS.)
					1	4+	
H-10520	96"	1	5"	6,800	\$175	\$170	55
H-10521	144"		6½"	7,000	295	290	100

SHIPS VIA MOTOR FREIGHT



## HEAVY-DUTY BOLTLESS SHELVING

Stylish black shelving stands out in industrial offices, retail spaces and warehouses.

- Quick, easy assembly. Shelves snap into place and adjust at 1½" increments.
- 14-gauge powder-coated steel posts with 5/8" particle board shelves.
- Durable, 2¼" double rivet beams for strength and rigidity.
- Additional shelves available, see [uline.com](http://uline.com)



### 72" HEIGHT

MODEL NO.	DIMENSIONS W x D x H	SHELF CAP. (LBS.)	NO. OF SHELVES	PRICE EACH		WT. (LBS.)
				1	3+	
H-8407	48 x 24 x 72"	800		\$200	\$190	98
■H-8408	60 x 24 x 72"	700	3	235	225	129
■H-8409	72 x 24 x 72"	550		260	250	147

■ SHIPS UNASSEMBLED VIA MOTOR FREIGHT

### 84" HEIGHT

MODEL NO.	DIMENSIONS W x D x H	SHELF CAP. (LBS.)	NO. OF SHELVES	PRICE EACH		WT. (LBS.)
				1	3+	
H-9957	48 x 24 x 84"	800		\$215	\$205	101
■H-9958	60 x 24 x 84"	700	3	250	240	132
■H-9959	72 x 24 x 84"	550		275	265	150

■ SHIPS UNASSEMBLED VIA MOTOR FREIGHT



## MOBILE WIDE SPAN STORAGE RACKS

Sturdy, heavy-duty shelving that doubles as a cart.

- Smooth, solid 5/8" particle board shelves eliminate item fall-through.
- Quick, easy assembly. Three shelves snap into place and adjust at 1½" increments. Includes 3 shelf supports.
- 5" locking swivel casters with steel foot plates.

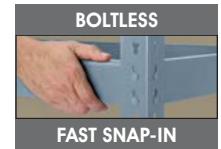

MODEL NO.	DIMENSIONS W x D x H	CAPACITY (LBS.)	NO. OF SHELVES	PRICE EACH		WT. (LBS.)
				1	3+	
H-7571	36 x 18 x 67"			\$240	\$230	95
H-7572	36 x 24 x 67"	600	3	255	245	118
H-10014	48 x 24 x 67"			290	280	131

SHIPS UNASSEMBLED VIA UPS

### ADDITIONAL SHELVES

MODEL NO.	PRICE EACH		WT. (LBS.)
	1	3+	
H-2188-ADD	\$51	\$49	21
H-2189-ADD	59	54	27
H-2191-ADD	70	66	33

## PORTABLE STACK RACKS

Easy to build, easy to take down. Flex your space.

- Use in lumberyards, construction sites, garden centers and warehouses.
- Quick, no-tool assembly. Stack up to 6 high.
- Powder-coated 10-gauge steel.
- Each rack includes one base and four posts.

### OUTDOOR/INDOOR USE

MODEL NO.	DIMENSIONS W x D x H	CAPACITY (LBS.)	PRICE EACH			WT. (LBS.)
			1	5	10+	
H-7471	48 x 48 x 36"		\$365	\$355	\$345	124
H-7472	48 x 48 x 48"	4,000	380	370	360	136
H-9221	48 x 48 x 60"		415	405	395	148

SHIPS UNASSEMBLED VIA MOTOR FREIGHT





# CLOSED INDUSTRIAL STEEL SHELVING

Enclosed heavy-duty shelves firmly hold gear and supplies in place.

- 24-gauge steel side and back panels eliminate product roll-off.
- 20-gauge steel shelves. Welded box beams, front and rear.
- Holds up to 800 lbs. per shelf. Adjustable in 1/2" increments with shelf clips.

## ADDITIONAL SHELVES

Add extra shelves to Closed Industrial Steel Shelving.

- Clip design for easy assembly.



H-4351



H-4353

### 75" HEIGHT

MODEL NO.	DIMENSIONS W x D x H	NO. OF SHELVES	SHELF CAP. (LBS.)	PRICE EACH			WT. (LBS.)
				1	3	5+	
H-7677	36 x 18 x 75"	6	800	\$425	\$415	\$405	129
H-7678	36 x 24 x 75"			485	475	465	160
H-7679	48 x 18 x 75"	6	550	545	535	525	155
H-7680	48 x 24 x 75"			615	605	595	182

SHIPS UNASSEMBLED VIA MOTOR FREIGHT

### ADDITIONAL SHELVES

MODEL NO.	PRICE EACH		WT. (LBS.)
	1	4+	
H-3353-ADD	\$38	\$37	10
H-3354-ADD	45	44	13
H-3355-ADD	53	51	13
H-3356-ADD	63	61	17

### 87" HEIGHT

MODEL NO.	DIMENSIONS W x D x H	NO. OF SHELVES	SHELF CAP. (LBS.)	PRICE EACH			WT. (LBS.)
				1	3	5+	
H-4351	36 x 18 x 87"	6	800	\$435	\$425	\$415	132
H-4352	36 x 24 x 87"			495	485	475	163
H-4353	48 x 18 x 87"	6	550	555	545	535	158
H-4354	48 x 24 x 87"			625	615	605	185

SHIPS UNASSEMBLED VIA MOTOR FREIGHT

### ADDITIONAL SHELVES

MODEL NO.	PRICE EACH		WT. (LBS.)
	1	4+	
H-3353-ADD	\$38	\$37	10
H-3354-ADD	45	44	13
H-3355-ADD	53	51	13
H-3356-ADD	63	61	17

# STRAIGHT WALL CONTAINERS

Reinforced containers for work-in-process, shipping and storage.

- Flat, smooth interior and molded handles maximize inside space.
- Polypropylene resists cracks, dents and extreme temperatures.



**900 LB. CAPACITY**

Optional lids, see [uline.com](http://uline.com)

- Straight walls allow tight stacking with no wasted space.
- Fully cube out 48 x 45" pallets.

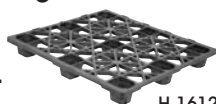

H-1612

### CONTAINERS

SPECIFY COLOR: Blue or Gray

MODEL NO.	INSIDE DIM. L x W x H	OUTSIDE DIM. L x W x H	CUBIC FT.	PRICE EACH (MIN. 3)			WT. (LBS.)
				3	12	24+	
S-19507	13 x 9 3/4 x 6 3/4"	15 x 12 x 7 1/2"	0.5	\$16	\$15	\$14	2
S-19508	13 x 9 3/4 x 8 3/4"	15 x 12 x 9 1/2"	0.6	17	16	15	3
S-22723	21 1/2 x 13 x 4 1/2"	24 x 15 x 5"	0.8	19	18	17	3
S-19509	21 1/2 x 13 x 6 3/4"	24 x 15 x 7 1/2"	1.1	22	21	20	4
S-19510	21 1/2 x 13 x 8 3/4"	24 x 15 x 9 1/2"	1.4	25	24	23	5
S-20580	21 1/2 x 13 x 13 3/4"	24 x 15 x 14 1/2"	2.4	32	31	30	6

### PALLET

MODEL NO.	SIZE L x W	WEIGHT CAPACITY		PRICE EACH (MIN. 5)			WT. (LBS.)
		FLOOR	FORK	5	10	25+	
H-1612	48 x 45"	5,000 lbs.	2,000 lbs.	\$41	\$40	\$39	24

SHIPS VIA MOTOR FREIGHT

# INDUSTRIAL STEEL SHELVING

All-purpose shelving for warehouses, stockrooms and machine shops.

- 20-gauge steel shelves. Welded box beams, front and rear. Powder-coat finish.
- Holds up to 800 lbs. per shelf.
- Shelves adjust in 1½" increments.
- Includes side and rear cross braces.

## ADDITIONAL SHELVES

Add extra shelves to Industrial Steel Shelving.

- Clip design for easy assembly.



### 75" HEIGHT

MODEL NO.	DIMENSIONS W x D x H	NO. OF SHELVES	SHELF CAP. (LBS.)	PRICE EACH			WT. (LBS.)
				1	3	5+	
H-3841	36 x 12 x 75"	6	800	\$240	\$230	\$220	70
H-3353	36 x 18 x 75"		800	275	265	255	83
■H-3354	36 x 24 x 75"		800	310	300	290	98
H-3842	48 x 12 x 75"	6	550	290	280	270	85
■H-3355	48 x 18 x 75"		550	350	340	330	100
■H-3356	48 x 24 x 75"		550	405	395	385	119

■ SHIPS UNASSEMBLED VIA MOTOR FREIGHT

### ADDITIONAL SHELVES

MODEL NO.	PRICE EACH		WT. (LBS.)
	1	4+	
H-3841-ADD	\$30	\$29	8
H-3353-ADD	38	37	10
H-3354-ADD	45	44	13
H-3842-ADD	39	38	10
H-3355-ADD	53	51	13
H-3356-ADD	63	61	17

### 87" HEIGHT

MODEL NO.	DIMENSIONS W x D x H	NO. OF SHELVES	SHELF CAP. (LBS.)	PRICE EACH			WT. (LBS.)
				1	3	5+	
H-3843	36 x 12 x 87"	6	800	\$250	\$240	\$230	73
H-2883	36 x 18 x 87"		800	285	275	265	86
■H-2884	36 x 24 x 87"		800	320	310	300	101
H-3844	48 x 12 x 87"	6	550	300	290	280	88
■H-2885	48 x 18 x 87"		550	365	355	345	104
■H-2886	48 x 24 x 87"		550	415	405	395	123

■ SHIPS UNASSEMBLED VIA MOTOR FREIGHT

### ADDITIONAL SHELVES

MODEL NO.	PRICE EACH		WT. (LBS.)
	1	4+	
H-3841-ADD	\$30	\$29	8
H-3353-ADD	38	37	10
H-3354-ADD	45	44	13
H-3842-ADD	39	38	10
H-3355-ADD	53	51	13
H-3356-ADD	63	61	17



## TIRE RACKS

Stock the tires you want, save the space you need. Essential for tire shops, car dealerships and wholesale clubs.

- Boltless assembly. Shelves snap into place and adjust at 1½" increments.
- 14-gauge steel posts. Tough, powder-coat finish.
- Single sided – Vertical storage that mounts to the wall.

MODEL NO.	DIMENSIONS W x D x H	NO. OF SHELVES	SHELF CAP. (LBS.)	TIRE CAPACITY	PRICE EACH		WT. (LBS.)
					1	2+	
H-4881	60 x 18 x 84"	3	1,400	18	\$205	\$195	72
■H-4882	96 x 18 x 84"		1,000	27	285	270	98

■ SHIPS UNASSEMBLED VIA MOTOR FREIGHT



## VERTICAL BAR RACK

Holds and organizes pipe, conduit and lumber in less space.

- Three 9" wide storage bay locations. 1,000 lb. capacity per bay.
- Three lipped shelves hold smaller items, parts or boxes.
- Strong 11-gauge steel posts. Tough, powder-coat finish.
- Safety chain keeps stock securely in place.
- Concrete anchoring hardware included.



Stacking U-Rack available, see [uline.com](http://uline.com)

MODEL NO.	DIMENSIONS W x D x H	NO. OF BAYS	CAPACITY (LBS.)	PRICE EACH		WT. (LBS.)
				1	2+	
H-4888	36 x 24 x 85"	3	3,000	\$295	\$285	125

SHIPS UNASSEMBLED VIA MOTOR FREIGHT



## FORK RACK New

Install and remove fork extensions without leaving the driver's seat!

- Safely store and organize multiple sizes in one rack.
- Sturdy steel construction. Bolt to floor for stability.
- Fork Extensions available, see page 598.

MODEL NO.	DIMENSIONS L x W x H	FITS FORK EXTENSIONS	CAP. (LBS.)	PRICE EACH		WT. (LBS.)
				1	2+	
H-10384	40 x 46 x 54"	60 - 96"	400	\$475	\$450	102

SHIPS UNASSEMBLED VIA MOTOR FREIGHT

## REEL RACKS

Store and dispense wire, rope and tubing with adjustable rack.

- 6 levels vertically adjust in 1½" increments to customize storage.
- Each level can hold up to 3 axles.
- Includes six 5/8" diameter axles.
- 14-gauge powder-coated steel construction.

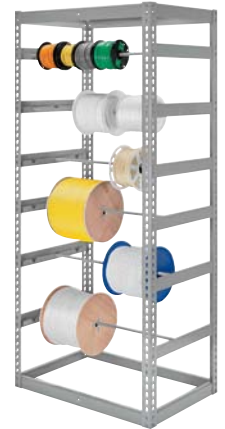

MODEL NO.	DIMENSIONS W x D x H	CAPACITY (LBS.)		PRICE EACH		WT. (LBS.)
		AXLE	UNIT	1	2+	
H-7841	36 x 24 x 84"	150	2,000	\$300	\$290	84
H-7842	48 x 24 x 84"	100	2,000	335	325	93

SHIPS UNASSEMBLED VIA UPS

## BAR AND PIPE CRADLE TRUCK

Every contractor needs one to transport oversized raw materials.

- All-welded, super heavy duty 3" channel steel construction.
- Open cradle design for easy loading and unloading. Reduces back strain.
- 8" swivel casters, 12" center wheels turn on a dime.



MODEL NO.	DIMENSIONS L x W x H	WHEEL TYPE	LOAD CAP. (LBS.)	PRICE EACH		WT. (LBS.)
				1	2+	
H-6186	96 x 30 x 30"	Phenolic	10,000	\$1,255	\$1,235	235

SHIPS ASSEMBLED VIA MOTOR FREIGHT

## VERTICAL SHEET RACK

Store and organize up to 3 tons of granite, plywood, drywall or metal sheets.

- Four 7" deep storage bays.
- Powder-coated steel construction.
- 14-gauge removable uprights range from 16 to 42" high.
- Concrete anchoring hardware included.
- Boltless assembly.



MODEL NO.	DIMENSIONS W x D x H	NO. OF BAYS	CAPACITY (LBS.)	PRICE EACH		WT. (LBS.)
				1	2+	
H-8383	48 x 36 x 42"	4	6,000	\$460	\$440	150

SHIPS UNASSEMBLED VIA MOTOR FREIGHT



# CANTILEVER RACKS

Store steel bars, conduit, pipes and other long materials.

- Easy loading and unloading. Arms adjust in 3" increments.
- Locking pin secures arms for quick, tool-free adjustment.
- Base can be used as extra storage.

## ADD-ON UNITS

Attach to starter unit to create a continuous rack system.

- Includes upright with base, arms, connecting brace set and hardware.

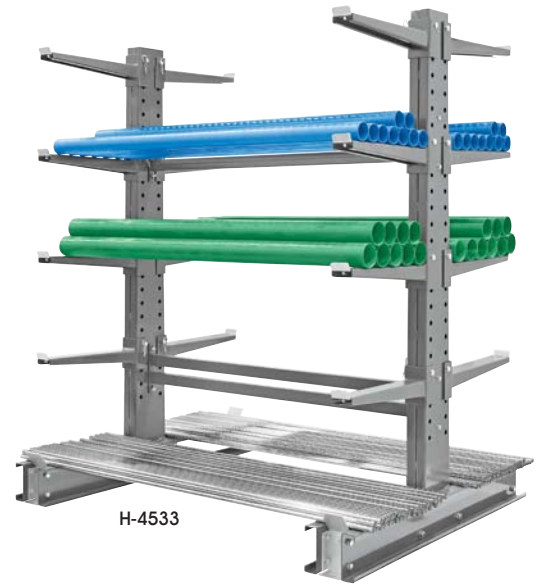

H-4533

### SINGLE SIDED STARTER UNITS

MODEL NO.	DIMENSIONS W x D x H	ARM LENGTH	NO. OF ARMS	ARM CAP. (LBS.)	CAPACITY/UNIT (LBS.)	PRICE EACH		WT. (LBS.)
						1	2+	
H-3845	56 x 40 x 96"	24"	8	650	7,500	\$1,480	\$1,435	359
H-3846	80 x 40 x 96"					1,505	1,460	364
H-4530	58 x 61 x 120"	48"	8	1,000	9,750	2,820	2,725	760
H-4531	82 x 61 x 120"					2,900	2,810	787

### SINGLE SIDED ADD-ON UNITS

MODEL NO.	PRICE EACH		WT. (LBS.)
	1	2+	
H-3845-ADD	\$800	\$770	192
H-3846-ADD	820	795	201
H-4530-ADD	1,555	1,515	412
H-4531-ADD	1,615	1,565	439

### DOUBLE SIDED STARTER UNITS

MODEL NO.	DIMENSIONS W x D x H	ARM LENGTH	NO. OF ARMS	ARM CAP. (LBS.)	CAPACITY/UNIT (LBS.)	PRICE EACH		WT. (LBS.)
						1	2+	
H-3847	56 x 65 x 96"	24"	16	650	15,000	\$1,995	\$1,940	485
H-3848	80 x 65 x 96"					2,020	1,965	490
H-4532	58 x 106 x 120"	48"	16	1,000	19,500	4,055	3,930	1,102
H-4533	82 x 106 x 120"					4,120	3,995	1,129

### DOUBLE SIDED ADD-ON UNITS

MODEL NO.	PRICE EACH		WT. (LBS.)
	1	2+	
H-3847-ADD	\$1,050	\$1,025	261
H-3848-ADD	1,075	1,050	270
H-4532-ADD	2,295	2,225	584
H-4533-ADD	2,365	2,285	611

SHIPS UNASSEMBLED VIA MOTOR FREIGHT

SHIPS UNASSEMBLED VIA MOTOR FREIGHT

# MOBILE BAR AND PIPE RACKS

Organize, store and transport pipe and conduit in the shop or warehouse.

- 3 double sided storage levels.
- 7" uprights on each arm keep load secure.
- All-welded, heavy duty 12-gauge steel construction.
- 8" casters – 2 swivel with brake, 2 rigid.

\* Evenly distributed

MODEL NO.	DIMENSIONS L x W x H	ARM LENGTHS TOP/MIDDLE/BOTTOM	CAPACITY/UNIT (LBS.)*	WHEEL TYPE	PRICE EACH		WT. (LBS.)
					1	2+	
H-4542	48 x 36 x 60"	6"/10"/14"	4,000	Phenolic	\$905	\$885	187
H-4543	72 x 36 x 60"				1,060	1,040	225

SHIPS ASSEMBLED VIA MOTOR FREIGHT



# HIGH CAPACITY REEL RACKS

Store and dispense heavy spools of wire, cable, tubing, rope or chain.

- Heavy duty steel construction holds up to 60" diameter spools.
- Axle brackets adjust in 2" increments.
- Includes 4 axles.



MODEL NO.	DIMENSIONS W x D x H	NO. OF AXLES	CAPACITY/AXLE (LBS.)	CAPACITY/UNIT (LBS.)	PRICE EACH		WT. (LBS.)
					1	2+	
H-4544	36 x 24 x 96"	4	2,000	10,000	\$1,035	\$1,000	157
H-4545	36 x 36 x 96"				1,060	1,025	161
H-4546	48 x 24 x 96"	4	2,000	10,000	1,050	1,015	168
H-4547	48 x 36 x 96"				1,070	1,035	172

SHIPS UNASSEMBLED VIA MOTOR FREIGHT



# KRAFT CORRUGATED BINS



Conceal oily fingerprints, dirt and grime.

- Easy-to-fold assembly.
- Sturdy 200 lb. test corrugated.

SOLD IN CARTONS OF 100

MODEL NO.	OUTSIDE DIM. W x L x H	LBS./CTN.	PRICE PER BIN		
			100	200	500+
9" DEEP BIN BOXES					
S-20013	2 x 9 x 4 1/2"	10	\$.92	\$.85	\$.81
S-17872	4 x 9 x 4 1/2"	15	.98	.92	.87
S-17873	6 x 9 x 4 1/2"	21	1.04	.98	.93
12" DEEP BIN BOXES					
S-17874	2 x 12 x 4 1/2"	14	\$.95	\$.91	\$.86
S-20014	3 x 12 x 4 1/2"	16	.99	.93	.89
S-16268	4 x 12 x 4 1/2"	20	1.04	.98	.93
S-16269	6 x 12 x 4 1/2"	25	1.14	1.05	.99
S-16270	8 x 12 x 4 1/2"	29	1.31	1.24	1.17
S-20015	10 x 12 x 4 1/2"	34	1.42	1.35	1.28
S-20016	12 x 12 x 4 1/2"	40	1.56	1.46	1.40
18" DEEP BIN BOXES					
S-20017	2 x 18 x 4 1/2"	17	\$1.16	\$1.12	\$1.04
S-16271	4 x 18 x 4 1/2"	25	1.37	1.29	1.24
S-16272	6 x 18 x 4 1/2"	35	1.67	1.59	1.50
S-16273	8 x 18 x 4 1/2"	39	1.80	1.70	1.62
S-17875	12 x 18 x 4 1/2"	44	2.11	2.04	1.96
24" DEEP BIN BOXES					
S-17876	4 x 24 x 4 1/2"	32	\$2.29	\$2.17	\$2.02
S-17877	6 x 24 x 4 1/2"	37	2.43	2.34	2.18
S-17878	8 x 24 x 4 1/2"	48	2.82	2.64	2.51
S-20018	12 x 24 x 4 1/2"	54	3.37	3.21	3.00

# WAREHOUSE RACK BINS



Giant 42" deep – Custom made for Uline.

Extra-long bins to keep warehouses neat and organized.

- Maximize space on your pallet racks.
- Prevent loose items from spilling off shelves.

SOLD IN BUNDLES OF 10

MODEL NO.	INSIDE DIM. W x L x H	LBS./BNDL.	PRICE PER BIN		
			10	50	100+
42" DEEP BIN BOXES					
S-15725	10 x 42 x 20"	23	\$6.58	\$6.24	\$5.86
S-15726	15 x 42 x 20"	27	8.64	8.12	7.69
S-15727	23 x 42 x 20"	35	11.17	10.42	9.90

■ SHIPS VIA MOTOR FREIGHT



# STACKABLE BINS

Double your shelf space.

- Closed tops for easy stacking.
- Sturdy 200 lb. test.

SOLD IN BUNDLES OF 50

MODEL NO.	OUTSIDE DIM. W x L x H	LBS./BNDL.	PRICE PER BIN		
			50	100	250+
12" DEEP BIN BOXES					
S-16302	2 x 12 x 4 1/2"	7	\$1.23	\$1.16	\$1.12
S-16303	4 x 12 x 4 1/2"	10	1.37	1.28	1.23
S-16304	8 x 12 x 4 1/2"	19	1.83	1.73	1.62
S-16305	12 x 12 x 4 1/2"	26	2.19	2.08	1.97
18" DEEP BIN BOXES					
S-16306	4 x 18 x 4 1/2"	16	\$1.77	\$1.70	\$1.60
S-16307	8 x 18 x 4 1/2"	26	2.50	2.38	2.26

# TALL TOTE BINS

Extra-high 12" sides prevent items from spilling out.



- Side hand holes for easy carrying.
- For 18" deep shelves.

SOLD IN CARTONS OF 10

MODEL NO.	OUTSIDE DIM. W x L x H	LBS./CTN.	PRICE PER BIN		MODEL NO.	LBS./CTN.	PRICE/PAD 10+
			10	20+			
18" DEEP BIN BOXES					18" DEEP STACKING PADS		
S-3895	11 x 18 x 12"	9	\$5.50	\$5.00	S-3896	10	\$2.40
S-3897	16 x 18 x 12"	12	7.20	6.60	S-3898	12	2.70

# WHITE CORRUGATED BINS

SOLD IN CARTONS OF 100

MODEL NO.	OUTSIDE DIM. W x L x H	LBS./ CTN.	PRICE PER BIN		
			100	200	500+
9" DEEP BIN BOXES					
S-2330	2 x 9 x 4 1/2"	10	\$.95	\$.89	\$.86
S-16264	3 x 9 x 4 1/2"	14	.99	.93	.91
S-2331	4 x 9 x 4 1/2"	15	1.03	.96	.93
S-2332	6 x 9 x 4 1/2"	21	1.12	1.04	.98
S-20019	8 x 9 x 4 1/2"	27	1.28	1.23	1.16
12" DEEP BIN BOXES					
S-703	2 x 12 x 4 1/2"	14	\$1.01	\$.95	\$.92
S-2282	3 x 12 x 4 1/2"	16	1.04	.98	.94
S-704	4 x 12 x 4 1/2"	20	.93	.93	.93
S-16265	5 x 12 x 4 1/2"	23	1.16	1.11	1.03
S-705	6 x 12 x 4 1/2"	25	1.23	1.14	1.06
S-706	8 x 12 x 4 1/2"	29	1.42	1.34	1.25
S-2283	10 x 12 x 4 1/2"	34	1.52	1.44	1.37
S-707	12 x 12 x 4 1/2"	40	1.65	1.56	1.47
S-16266	16 x 12 x 4 1/2"	48	1.91	1.81	1.71
18" DEEP BIN BOXES					
S-3542	2 x 18 x 4 1/2"	17	\$1.24	\$1.17	\$1.13
S-3543	3 x 18 x 4 1/2"	19	1.29	1.24	1.17
S-1051	4 x 18 x 4 1/2"	25	1.45	1.40	1.31
S-16267	5 x 18 x 4 1/2"	30	1.61	1.53	1.45
S-1052	6 x 18 x 4 1/2"	35	1.79	1.70	1.61
S-1053	8 x 18 x 4 1/2"	39	1.91	1.81	1.74
S-2284	10 x 18 x 4 1/2"	40	2.11	2.04	1.92
S-2285	12 x 18 x 4 1/2"	44	2.26	2.18	2.04
S-20020	18 x 18 x 4 1/2"	67	2.91	2.78	2.63
24" DEEP BIN BOXES					
S-20021	2 x 24 x 4 1/2"	23	\$1.98	\$1.86	\$1.76
S-2718	4 x 24 x 4 1/2"	32	2.42	2.32	2.18
S-2719	6 x 24 x 4 1/2"	37	2.62	2.50	2.34
S-2720	8 x 24 x 4 1/2"	48	2.99	2.82	2.69
S-15582	12 x 24 x 4 1/2"	54	3.57	3.40	3.19



Warehouses operate most efficiently when everything is in its place. Bins organize parts, supplies, small products, etc.

- Easy assembly – No tape or staples needed.
- 200 lb. test corrugated.

## BIN DIVIDERS

Separate bins into handy sections.

- Flaps fold back to fit snugly into bins.



SOLD IN CARTONS OF 100

MODEL NO.	FOR BINS	LBS./ CTN.	PRICE PER DIVIDER	
			100	200+
S-3530	4" wide	3	\$.43	\$.42
S-3531	6" wide	4	.44	.43
S-3532	8" wide	5	.45	.44

# LARGE BINS

Store larger items. Products are protected by higher sides.

- Available in 12", 18" or 24" depth.
- 4" front lip.

SOLD IN CARTONS OF 25

MODEL NO.	OUTSIDE DIM. W x L x H	LBS./ CTN.	PRICE PER BIN		
			25	50	125+
12" DEEP BIN BOXES					
S-3890	8 x 12 x 8"	11	\$2.43	\$2.34	\$2.21
S-3891	10 x 12 x 8"	13	2.60	2.48	2.36
S-3892	12 x 12 x 8"	15	2.84	2.72	2.57
18" DEEP BIN BOXES					
S-16298	6 x 18 x 10"	17	\$3.52	\$3.32	\$3.17
S-3893	8 x 18 x 10"	17	3.79	3.56	3.40
S-5811	10 x 18 x 10"	19	4.13	3.95	3.76
S-3894	12 x 18 x 10"	21	4.27	4.11	3.89
■S-16299	18 x 18 x 10"	30	4.91	4.74	4.49
■S-16300	20 x 18 x 10"	32	5.14	4.97	4.69

■ SHIPS VIA MOTOR FREIGHT



SOLD IN CARTONS OF 25

MODEL NO.	OUTSIDE DIM. W x L x H	LBS./ CTN.	PRICE PER BIN		
			25	50	125+
24" DEEP BIN BOXES					
■S-16301	8 x 24 x 12"	26	\$5.18	\$5.01	\$4.73
■S-9884	12 x 24 x 12"	32	5.76	5.52	5.25
■S-15668	16 x 24 x 12"	35	6.20	5.95	5.64
■S-20022	18 x 24 x 12"	37	6.52	6.24	5.93
■S-15669	20 x 24 x 12"	39	6.81	6.54	6.19

■ SHIPS VIA MOTOR FREIGHT



# PLASTIC SHELF BINS

Long-lasting storage for small parts and components.



- Nest to save storage space.
- FDA compliant resins.
- Molded label holder to identify contents.
- Rear notch allows bins to slide and hang open on Shelf Bin Organizers, see page 497.

## 12" DEEP BIN BOXES SPECIFY BIN COLOR: Blue, Red, Yellow, Green or Black

MODEL NO.	OUTSIDE DIM. W x L x H	QTY./ CTN.	LBS./ CTN.	PRICE EACH (SOLD IN CTN. QTYs.)	
				1	3+
S-15641	2½ x 12 x 4"	36	9	\$1.70	\$1.65
S-13396	4 x 12 x 4"	24	7	\$1.75 any quantity	
S-13397	7 x 12 x 4"	20	9	2.70	2.55
S-13398	8½ x 12 x 4"	12	8	3.20	3.10
S-19944	11 x 12 x 4"	9	7	4.05	3.95
S-16275	4 x 12 x 6"	18	9	3.15	3.05
S-16276	7 x 12 x 6"	12	8	4.55	4.35
S-16277	8½ x 12 x 6"	9	6	5.45	5.30
S-16278	11 x 12 x 6"	9	8	6.70	6.50
S-23363	4 x 12 x 8"	36	27	5.45	5.15
S-23364	7 x 12 x 8"	30	27	7.65	7.35

## 18" DEEP BIN BOXES SPECIFY BIN COLOR: Blue, Red, Yellow, Green or Black

MODEL NO.	OUTSIDE DIM. W x L x H	QTY./ CTN.	LBS./ CTN.	PRICE EACH (SOLD IN CTN. QTYs.)	
				1	3+
S-15644	4 x 18 x 6"	18	15	\$4.55	\$4.35
S-15645	7 x 18 x 6"	12	13	5.45	5.30
S-15646	8½ x 18 x 6"	9	11	7.95	7.65
S-15647	11 x 18 x 6"	9	13	12.50	12.05

## 18" DEEP BIN BOXES SPECIFY BIN COLOR: Blue, Red, Yellow, Green or Black

S-13399	4 x 18 x 4"	24	11	\$2.75	\$2.60
S-13400	7 x 18 x 4"	20	12	3.70	3.55
S-13401	8½ x 18 x 4"	12	10	4.75	4.60
S-19945	11 x 18 x 4"	9	10	7.90	7.65

## 24" DEEP BIN BOXES SPECIFY BIN COLOR: Blue, Red, Yellow, Green or Black

MODEL NO.	OUTSIDE DIM. W x L x H	QTY./ CTN.	LBS./ CTN.	PRICE EACH (SOLD IN CTN. QTYs.)	
				1	3+
S-14625	4 x 24 x 4"	12	9	\$5.00	\$4.85
S-14626	7 x 24 x 4"	10	10	7.00	6.75
S-14627	8½ x 24 x 4"	6	8	8.75	8.40
S-19946	11 x 24 x 4"	6	10	11.75	11.30
S-23365	4 x 24 x 6"	16	19	8.90	8.35
S-23366	7 x 24 x 6"	8	12	11.70	11.10
S-23085	8½ x 24 x 6"	6	11	18.60	18.00
S-23086	11 x 24 x 6"	6	12	22.00	21.20



## SHELF BIN DIVIDERS

Separate bins into handy compartments.

- Keep small parts organized.
- Create up to 8 sections.



Bin Cups and Bin Label Holders, see [uline.com](http://uline.com)



## SHELF BIN DIVIDERS

MODEL NO.	DIMENSIONS W x H	QTY./ PACK	LBS./ PACK	PRICE PER PACK	
				1	3+
S-13396D	4 x 4"	50	2	\$19.75	\$18.75
S-13397D	7 x 4"		3	22.50	20.25
S-13398D	8½ x 4"		4	43.75	42.75
S-19944D	11 x 4"		7	57.25	55.00
S-16275D	4 x 6"	50	3	44.50	43.25
S-16276D	7 x 6"		5	47.75	46.75
S-16277D	8½ x 6"		6	106.50	104.00
S-16278D	11 x 6"		8	124.00	121.00
S-23367	4 x 8"	50	4	92.00	89.50
S-23368	7 x 8"		6	109.00	106.50

# CLEAR PLASTIC SHELF BINS



See-through storage for quick identification.

- Nestable when empty.
- Chemical resistant. FDA compliant.
- Convenient molded-in label holder.

## 12" DEEP BIN BOXES Additional sizes, see [uline.com](http://uline.com)

MODEL NO.	OUTSIDE DIM. W x L x H	QTY./ CTN.	LBS./ CTN.	PRICE EACH (SOLD IN CTN. QTYs.)	
				1	3+
S-16292	4 x 12 x 4"	24	8	\$2.00	\$1.90
S-16293	7 x 12 x 4"	20	9	3.00	2.90
S-16294	8½ x 12 x 4"	12	7	3.50	3.40

## 18" DEEP BIN BOXES

S-16295	4 x 18 x 4"	24	12	\$3.05	\$2.95
S-16296	7 x 18 x 4"	20	12	4.00	3.85
S-16297	8½ x 18 x 4"	12	10	5.40	5.20

# ULINE PLASTIC STACKABLE BINS

Keep small parts organized in less space. Ideal for workbenches and assembly areas.

- Reinforced walls for stable, non-shift stacking.
- Front, back and side grips for easy handling.
- Lids available, see page 492.



SPECIFY COLOR: Red White Blue Yellow Green Clear Black

SOLD IN CARTON QUANTITIES

MODEL NO.	OUTSIDE DIM. L x W x H	QTY./ CTN.	LBS./ CTN.	PRICE PER BIN		
				1 CTN.	3 CTNS.	6+ CTNS.
S-12413	5½ x 4 x 3"	24	5	\$1.40	\$1.35	\$1.30
S-12414	7½ x 4 x 3"	24	5	1.90	1.85	1.75
S-20581	9½ x 6 x 5"	12	7	4.95	4.80	4.65
S-13536	11 x 4 x 4"	12	7	3.45	3.35	3.25
S-12415	11 x 5½ x 5"	12	7	\$4.15 any quantity		
S-12416	11 x 8 x 7"	6	7	9.05	8.65	8.30
S-12417	11 x 11 x 5"	6	6	8.40	8.00	7.65

SOLD IN CARTON QUANTITIES

MODEL NO.	OUTSIDE DIM. L x W x H	QTY./ CTN.	LBS./ CTN.	PRICE PER BIN		
				1 CTN.	3 CTNS.	6+ CTNS.
S-13537	11 x 16½ x 5"	6	10	\$12.85	\$12.20	\$11.65
S-12418	15 x 5½ x 5"	12	10	7.55	7.20	6.95
S-12419	15 x 8 x 7"	12	16	\$7.50 any quantity		
S-12420	15 x 16½ x 7"	6	15	12.35	11.70	11.15
S-14454	18 x 8 x 9"	6	14	19.95	19.00	18.10
S-12421	18 x 11 x 10"	4	10	19.75	18.85	17.85
S-12422	18 x 16½ x 11"	3	13	25.75	24.50	23.50

## STACKABLE BIN DIVIDERS

Separate bins into handy sections.

- Black plastic dividers fit snugly into bins.



MODEL NO.	FOR BINS L x H	QTY./ PACK	LBS./ PACK	PRICE PER PACK	
				1	3+
S-12413D	5½ x 3"	6	.2	\$7.75	\$7.45
S-12414D	7½ x 3"		.2	8.45	8.10
S-12415D	11 x 5"		1	10.10	9.40
S-12416D	11 x 7"		2	13.80	13.10
S-12419D	15 x 7"	6	2	14.20	13.50
S-14454D	18 x 9"		4	26.95	25.95
S-12421D	18 x 10"		4	27.65	26.65
S-12422D	18 x 11"		4	28.70	27.30

## LABEL HOLDERS AND INSERTS

Identify your bins with these self-adhering label holders.

- Includes perforated sheets of inserts.
- Laser/inkjet printer compatible.



MODEL NO.	DIMENSIONS W x H	QTY./ PACK	LBS./ PACK	PRICE PER PACK	
				1	3+
S-12552	3 x 1"	25	.4	\$15	\$14
S-15578	4 x 1¼"		.5	20	19
S-15579	4 x 2¼"		.6	27	25

## CLEAR PLASTIC BINS

Recommended for retail, pharmacies or at home.

- See-through design allows easy identification.
- Durable one-piece construction. Stackable.
- See chart above for sizes and pricing.



# STACKABLE BIN ORGANIZERS

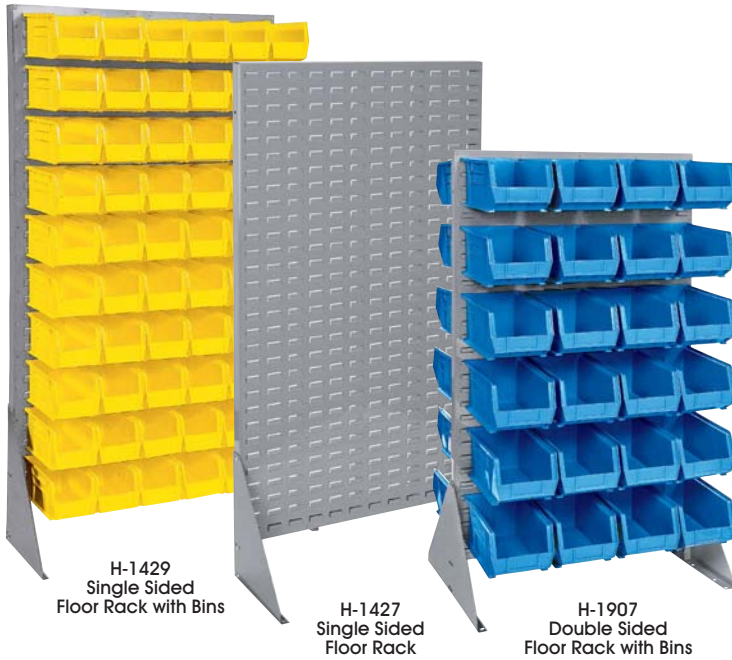

Maximum storage in minimum space.

**Floor Rack** – Stands alone in only 3 ft. of floor space.

**Double Sided Floor Rack** – Double the storage using no extra floor space.

**Bench Rack** – Mounts to packing and assembly tables.

**Panel Rack** – Mounts on walls; saves floor and workbench space.

## FLOOR RACKS

MODEL NO.	DESCRIPTION	SIZE W x H	WT. (LBS.)	PRICE EACH	
				1	2+
H-1427	Single Sided	36 x 66"	71	\$385	\$375
H-1904	Double Sided	36 x 66"	114	535	525

## SINGLE SIDED FLOOR RACK W/ BINS

SPECIFY BIN COLOR: Blue, Red, Green, White, Yellow, Clear or Black

MODEL NO.	BIN SIZE L x W x H	BINS/RACK	WT. (LBS.)	PRICE EACH	
				1	2+
H-1428	7½ x 4 x 3"	120	98	\$535	\$520
H-1429	11 x 5½ x 5"	60	110	560	545
H-1430	15 x 8 x 7"	24	104	520	505

## DOUBLE SIDED FLOOR RACK W/ BINS

SPECIFY BIN COLOR: Blue, Red, Green, White, Yellow, Clear or Black

MODEL NO.	BIN SIZE L x W x H	BINS/RACK	WT. (LBS.)	PRICE EACH	
				1	2+
H-1905	7½ x 4 x 3"	240	157	\$840	\$820
H-1906	11 x 5½ x 5"	120	187	880	860
H-1907	15 x 8 x 7"	48	181	810	790

SHIPS UNASSEMBLED VIA MOTOR FREIGHT

## BENCH RACK

MODEL NO.	DESCRIPTION	SIZE W x H	WT. (LBS.)	PRICE EACH	
				1	2+
H-1424	Bench Rack	37 x 19"	17	\$115	\$110

## BENCH RACK W/ BINS

SPECIFY BIN COLOR: Blue, Red, Green, White, Yellow, Clear or Black

MODEL NO.	BIN SIZE L x W x H	BINS/RACK	WT. (LBS.)	PRICE EACH	
				1	2+
H-1908	5½ x 4 x 3"	24	21	\$135	\$130
H-1425	7½ x 4 x 3"	24	22	145	140
H-1426	11 x 5½ x 5"	12	24	150	145

## PANEL RACK – WALL MOUNT

MODEL NO.	DESCRIPTION	SIZE W x H	WT. (LBS.)	PRICE EACH	
				1	2+
H-1492	Panel Rack	36 x 19"	13	\$78	\$75

## PANEL RACK W/ BINS

SPECIFY BIN COLOR: Blue, Red, Green, White, Yellow, Clear or Black

MODEL NO.	BIN SIZE L x W x H	BINS/RACK	WT. (LBS.)	PRICE EACH	
				1	2+
H-1909	5½ x 4 x 3"	24	17	\$100	\$95
H-1493	7½ x 4 x 3"	24	18	110	105
H-1494	11 x 5½ x 5"	12	20	115	110

## STACKABLE BIN LIDS



Keep bin contents clean and visible.

- Rear hinge opens and closes smoothly.
- Additional sizes, see [uline.com](http://uline.com)

SOLD IN CARTON QUANTITIES

MODEL NO.	FOR BINS L x W	QTY./CTN.	LBS./CTN.	PRICE PER LID	
				1 CTN.	3+ CTNS.
S-20790	7½ x 4"	24	3	\$2.10	\$2.05
S-20792	11 x 5½"	12	4	3.55	3.40

## WALL MOUNT SINGLE RAIL



Mounts to walls, trucks and workbenches.

H-4684

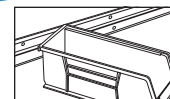

- Mounting hardware included.

## WITH BINS – 48 x 3"

SPECIFY BIN COLOR: Blue, Red, Green, White, Yellow, Clear or Black

MODEL NO.	BIN SIZE L x W x H	BINS/RAIL	WT. (LBS.)	PRICE EACH	
				1	2+
H-4682	11 x 4 x 4"	11	10	\$72	\$69
H-4684	11 x 5½ x 5"	8	12	78	75



# STACKABLE BIN STORAGE CABINETS



H-8345

**90 Bin Cabinet**  
 (90) 5½ x 4 x 3" (4) Adjustable shelves



H-8346

**102 Bin Cabinet**  
 (48) 5½ x 4 x 3" (3) Adjustable shelves  
 (48) 7½ x 4 x 3" (6) 15 x 16½ x 7"



H-8347

**138 Bin Cabinet** (24) 11 x 5½ x 5"  
 (48) 5½ x 4 x 3" (12) 15 x 8 x 7"  
 (48) 7½ x 4 x 3" (6) 15 x 16½ x 7"



H-4449

**126 Bin Cabinet**  
 (72) 5½ x 4 x 3" (3) Adjustable shelves  
 (48) 7½ x 4 x 3" (6) 15 x 16½ x 7"



H-2488

**168 Bin Cabinet** (24) 11 x 5½ x 5"  
 (72) 5½ x 4 x 3" (18) 15 x 8 x 7"  
 (48) 7½ x 4 x 3" (6) 15 x 16½ x 7"

SPECIFY BIN COLOR: Blue, Red, Green, White, Yellow, Clear or Black

MODEL NO.	DESCRIPTION	NO. OF SHELVES	CABINET SIZE W x D x H	WT. (LBS.)	PRICE EACH	
					1	2+
H-8344	Empty Cabinet	0	36 x 24 x 78"	273	\$1,285	\$1,225
H-8345	90 Bin Cabinet	4		342	1,595	1,535
H-8346	102 Bin Cabinet	3		345	1,625	1,565
H-8347	138 Bin Cabinet	0		333	1,635	1,575
H-2487	Empty Cabinet	0	48 x 24 x 78"	369	1,590	1,530
H-4449	126 Bin Cabinet	3		464	2,020	1,960
H-2488	168 Bin Cabinet	0		452	2,035	1,975

SHIPS ASSEMBLED VIA MOTOR FREIGHT

Protect all your expensive tools and parts from dust, damage and theft.

- Rugged, all-welded 16-gauge steel cabinet. Powder-coat finish.
- Easily adjustable bins hang on louvered panels.
- Doors have 3-point locking system.

**H-8344 and H-2487** – Customize your own cabinet with bins on page 491.

# MOBILE BIN STORAGE CABINETS



Secure parts organizer rolls easily for cleaning and repositioning.

- Rugged, all-welded 16-gauge steel cabinet. Powder-coat finish.
- Easily adjustable bins hang on louvered panels.
- 3-point locking system. Keys included. • 4" locking polyurethane swivel casters.

H-9053 and H-9054 – Customize your own cabinet. Bins, see page 491.

SPECIFY BIN COLOR: Blue, Red, Green, White, Yellow, Clear or Black

MODEL NO.	DESCRIPTION	NO. OF SHELVES	SIZE W x D x H	WT. (LBS.)	PRICE EACH	
					1	2+
H-9053	Empty Cabinet	0	36 x 24 x 84"	333	\$1,420	\$1,360
H-9048	90 Bin Cabinet	4		407	1,720	1,660
H-9049	102 Bin Cabinet	3		408	1,745	1,685
H-9050	138 Bin Cabinet	0		394	1,760	1,700
H-9054	Empty Cabinet	0	48 x 24 x 84"	446	1,715	1,655
H-9051	126 Bin Cabinet	3		549	2,145	2,085
H-9052	168 Bin Cabinet	0		526	2,155	2,095

Bin configuration detail, see page 493

SHIPS ASSEMBLED VIA MOTOR FREIGHT

# MODULAR DRAWER CABINETS



Industrial-grade storage for organizing expensive tools and parts.

- Welded, double-wall steel construction. Forkliftable.
- Adjustable metal dividers. Up to 24 compartments per drawer.
- Full-extension drawers with heavy-duty roller bearings.
- Central locking system secures cabinet with one lock.



For additional drawer dividers, see [uline.com](http://uline.com)

MODEL NO.	NO. OF DRAWERS	DIMENSIONS W x D x H	DRAWER HEIGHT	WT. (LBS.)	PRICE EACH	
					1	2+
H-8421	5	29 x 29 x 34"	(3) 4", (1) 6", (1) 8"	300	\$1,265	\$1,235
H-9842	7	29 x 29 x 44"	(4) 4", (2) 6", (1) 8"	355	1,800	1,755
H-8422	9	29 x 29 x 62"	(9) 6"	523	2,245	2,195
H-8423	11		(4) 3", (3) 4", (2) 6", (1) 8", (1) 10"	539	2,330	2,275
H-8985	14		(6) 3", (6) 4", (2) 6"	545	2,770	2,695
H-8986	11		41 x 29 x 62"	(4) 3", (3) 4", (2) 6", (1) 8", (1) 10"	675	2,650

3 AND 4" HEIGHT DRAWERS: 165 lb. capacity.  
6, 8 AND 10" HEIGHT DRAWERS: 440 lb. capacity.

SHIPS ASSEMBLED VIA MOTOR FREIGHT

# CARGO BOXES

RUBBERMAID®

Keep tools, hoses and equipment contained and secure.

- Weather and impact resistant, even in freezing temperatures.

MODEL NO.	INSIDE DIMENSIONS L x W x H	CAP. (GAL.)	QTY./ CTN.	LBS./ CTN.	PRICE EACH	
					1	2+
H-1404	32 x 16 x 14"	35	1	20	\$105	\$100
H-1405	41 x 17 x 14"	48			125	120

- Hinged lid.
- Stackable – 150 lb. capacity.
- Secure with a padlock.





# MOBILE CLEAR-VIEW BIN CABINETS

Provides visibility and mobility in repair shops, stockrooms and warehouses.

- All-welded 16-gauge steel cabinet with clear acrylic windows.
- Plastic stackable bins easily adjust on rear louvered panel.
- 3-point locking doors. • 4" locking polyurethane swivel casters.

H-9896 and H-9898 – Customize your own cabinet with bins, see page 491.

SPECIFY BIN COLOR: Blue, Red, Green, White, Yellow, Clear or Black

MODEL NO.	DESCRIPTION	DIMENSIONS W x D x H	WT. (LBS.)	PRICE EACH	
				1	2+
H-9896	Empty Cabinet	36 x 24 x 84"	322	\$1,470	\$1,425
H-9897	42 Bin Cabinet		367	1,700	1,635
H-9898	Empty Cabinet	48 x 24 x 84"	390	1,735	1,685
H-9899	48 Bin Cabinet		452	1,975	1,905

Bin configuration detail, see page 506

SHIPS ASSEMBLED VIA MOTOR FREIGHT



# GIANT STACKABLE BIN ORGANIZERS

Convenient storage for frequent access of bulky tape guns and safety gear.

- Large bins with wide cut-out front opening for easy picking.
- Open wire shelving prevents dust buildup and maximizes airflow.
- Assemble in minutes. No tools or hardware required.
- Optional 5" polyurethane swivel casters add mobility.

SPECIFY BIN COLOR: Blue, Gray, Red or Clear

MODEL NO.	RACK SIZE W x D x H	BIN SIZE L x W x H	BINS/RACK	WT. (LBS.)	PRICE EACH	
					1	2+
H-9900	36 x 18 x 72"	17½ x 10½ x 12½"	12	109	\$455	\$440
H-9901		17½ x 16½ x 12½"	8	106	450	435
H-9902		(6) 17½ x 10½ x 12½" (4) 17½ x 16½ x 12½"	10	113	475	460
H-9903	48 x 18 x 72"	15 x 20 x 12½"	8	129	505	490
H-1205WH	Set of 4 Lockable Casters			12	75	72

SHIPS UNASSEMBLED VIA UPS

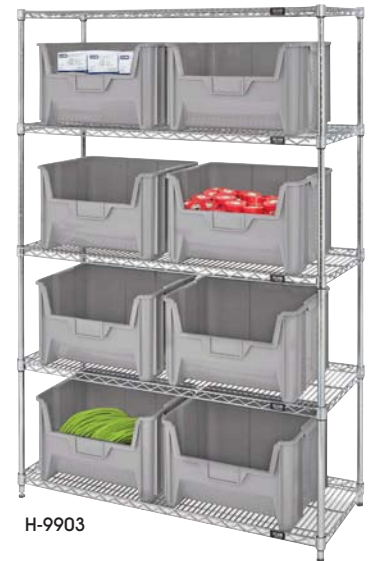

# MAGNUM HOPPER BIN ORGANIZERS

Super-sized bins. Store and organize your largest and heaviest supplies.

- Large bins with extra-thick, reinforced walls won't bow, crack or warp.
- Open wire shelving prevents dust buildup and maximizes airflow.
- Assemble in minutes. No tools or hardware required.
- Optional 5" polyurethane swivel casters add mobility.

SPECIFY BIN COLOR: Blue, Red or Yellow

MODEL NO.	RACK SIZE W x D x H	BIN SIZE L x W x H	BINS/RACK	WT. (LBS.)	PRICE EACH	
					1	2+
H-9906	36 x 24 x 72"	24 x 11 x 10"	15	179	\$740	\$715
H-9907		24 x 17 x 11"	10	173	720	695
H-9908	48 x 24 x 72"	20 x 18 x 12"	8	175	705	680
H-1205WH	Set of 4 Lockable Casters			12	75	72

SHIPS UNASSEMBLED VIA UPS





# MOBILE STACKABLE BIN ORGANIZERS

## STANDARD

Rolls easily anywhere you need it. Supports up to 500 lbs.

- 16-gauge steel construction. Attractive powder-coat finish.
- 4" polyolefin casters: 2 rigid, 2 swivel for maneuverability.

## PANEL

Heavy-duty louvered panel supports up to 800 lbs.

- 16-gauge steel construction with sturdy solid base.
- Bins attach easily and securely. • 5" polyurethane casters.



STANDARD



PANEL

### STANDARD

SHIPS UNASSEMBLED VIA UPS

MODEL NO.	DESCRIPTION	SIZE W x H	WT. (LBS.)	PRICE EACH	
				1	2+
H-1488	Standard Mobile	36 x 58"	75	\$485	\$475

### PANEL

SHIPS UNASSEMBLED VIA MOTOR FREIGHT

MODEL NO.	DESCRIPTION	SIZE W x H	WT. (LBS.)	PRICE EACH	
				1	2+
H-3888	Panel Mobile	36 x 71"	162	\$665	\$655

### STANDARD W/ STACKABLE BINS

SPECIFY BIN COLOR: Blue, Red, Green, White, Yellow, Clear or Black

MODEL NO.	BIN SIZE L x W x H	BINS/RACK	WT. (LBS.)	PRICE EACH	
				1	2+
H-1489	11 x 5½ x 5"	96	134	\$810	\$790
H-1490	11 x 11 x 5"	48	122	770	750
H-2643	15 x 5½ x 5"	96	157	1,020	995

### PANEL W/ STACKABLE BINS

SPECIFY BIN COLOR: Blue, Red, Green, White, Yellow, Clear or Black

MODEL NO.	BIN SIZE L x W x H	BINS/RACK	WT. (LBS.)	PRICE EACH	
				1	2+
H-3889	7½ x 4 x 3"	240	205	\$985	\$965
H-3890	11 x 5½ x 5"	120	235	1,090	1,065
H-3891	15 x 8 x 7"	48	229	985	965



STATIONARY



MOBILE

# GRAVITY SHELF BIN ORGANIZERS

## STATIONARY

Sloped shelves provide fast, easy access to small parts and supplies.

- Bin contents flow forward as parts are pulled.
- Single-sided design fits tight to the wall for space savings.

## MOBILE

Easy access sloped shelves roll easily from storage to work areas.

- Double-sided for higher capacity and efficiency. Pick from both sides.
- Includes steel dolly with 5" polyurethane casters.

### STATIONARY

SHIPS UNASSEMBLED VIA MOTOR FREIGHT

MODEL NO.	DESCRIPTION	SIZE W x H	WT. (LBS.)	PRICE EACH	
				1	2+
H-3892	Stationary Gravity	36 x 61"	51	\$305	\$295

### MOBILE

SHIPS UNASSEMBLED VIA MOTOR FREIGHT

MODEL NO.	DESCRIPTION	SIZE W x H	WT. (LBS.)	PRICE EACH	
				1	2+
H-3895	Mobile Gravity	39 x 68"	150	\$760	\$745

### STATIONARY W/ SHELF BINS

SPECIFY BIN COLOR: Blue, Red, Yellow, Green or Black

MODEL NO.	BIN SIZE W x L x H	BINS/RACK	WT. (LBS.)	PRICE EACH	
				1	2+
H-3893	4 x 12 x 4"	64	75	\$420	\$410
H-3894	7 x 12 x 4"	40	69	410	400

### MOBILE W/ SHELF BINS

SPECIFY BIN COLOR: Blue, Red, Yellow, Green or Black

MODEL NO.	BIN SIZE W x L x H	BINS/RACK	WT. (LBS.)	PRICE EACH	
				1	2+
H-3896	4 x 12 x 4"	128	193	\$935	\$915
H-3897	7 x 12 x 4"	80	186	900	880



# ULTRA CLEAR BINS

Maximum clarity and visibility for quick identification of bin contents.

- Durable polycarbonate resists cracks and chips. • Stack or hang on a panel rack.

### BINS

SOLD IN CARTON QUANTITIES LIDS

SOLD IN PACKS

MODEL NO.	OUTSIDE DIM. L x W x H	QTY./CTN.	LBS./CTN.	PRICE PER BIN		MODEL NO.	QTY./PACK	PRICE PER LID
				1 CTN.	3+ CTNS.			
S-20026	7½ x 4½ x 3¼"	16	7	\$6.20	\$5.90	S-20272	8	\$4.60
S-20027	10½ x 5½ x 5¼"	12	12	12.30	11.80	S-20273	6	6.80

# SHELF BIN ORGANIZERS

## STEEL SHELVING

MODEL NO.	RACK SIZE W x D x H	NO. OF SHELVES	WT. (LBS.)	PRICE EACH	
				1	2+
H-2510	36 x 12 x 39"	6	57	\$175	\$170
H-2644	36 x 18 x 39"		67	225	215
H-1770	36 x 12 x 75"	12	102	300	290
H-1771	36 x 18 x 75"		120	385	375

SHIPS UNASSEMBLED VIA UPS

## STEEL SHELVING WITH PLASTIC BINS

MODEL NO.	RACK SIZE W x D x H	BIN SIZE W x L x H	BINS/RACK	WT. (LBS.)	PRICE EACH		
					1	2+	
H-2511	36 x 12 x 39"	4 x 12 x 4"	48	71	\$245	\$235	
H-2512		7 x 12 x 4"	30	75	260	250	
H-2645	36 x 18 x 39"	7 x 18 x 4"	30	90	345	325	
H-2646		11 x 18 x 4"	18	85	345	325	
H-2513	36 x 12 x 75"	2¼ x 12 x 4"	144	136	515	490	
H-1772		4 x 12 x 4"	96	130	450	425	
H-1773		7 x 12 x 4"	60	130	430	405	
H-1774		8½ x 12 x 4"	48	128	425	400	
H-2514		11 x 12 x 4"	36	126	420	395	
H-1775		36 x 18 x 75"	4 x 18 x 4"	96	163	605	575
H-1776			7 x 18 x 4"	60	154	565	530
H-1777			8½ x 18 x 4"	48	160	580	545
H-2239	11 x 18 x 4"		36	157	635	600	

SPECIFY BIN COLOR: Blue, Red, Yellow, Green or Black SHIPS UNASSEMBLED VIA UPS

## STEEL SHELVING WITH CLEAR PLASTIC BINS

MODEL NO.	RACK SIZE W x D x H	BIN SIZE W x L x H	BINS/RACK	WT. (LBS.)	PRICE EACH	
					1	2+
H-4423	36 x 12 x 39"	7 x 12 x 4"	30	75	\$280	\$270
H-4424	36 x 18 x 39"	7 x 18 x 4"	30	90	385	365
H-4425	36 x 12 x 75"	4 x 12 x 4"	96	130	490	465
H-4426		7 x 12 x 4"	60	130	475	450
H-4427	36 x 18 x 75"	4 x 18 x 4"	96	163	665	630
H-4428		7 x 18 x 4"	60	154	620	585

SHIPS UNASSEMBLED VIA UPS



H-2512

Get organized! Bins offer easy access to small parts and accessories.

- Maintenance free, powder-coated steel frame won't rust or corrode.



Moisture-resistant plastic bins slide and lock for convenience.



H-1773

- Shelves adjust in 1" increments.
- Clear bins allow for quick identification of contents.



H-4423

# WIRE STACKABLE BIN ORGANIZERS

Attractive chrome organizers. Store parts and supplies in factories and repair shops.

- Open wire design prevents dust buildup and maximizes airflow.
- Assemble in minutes. No tools or hardware required. NSF certified.

## WIRE SHELVING WITH PLASTIC BINS

MODEL NO.	RACK SIZE W x D x H	BIN SIZE L x W x H	BINS/RACK	WT. (LBS.)	PRICE EACH	
					1	2+
H-9881	36 x 18 x 72"	11 x 5½ x 5"	60	155	\$620	\$605
H-9882		(36) 11 x 5½ x 5" (12) 15 x 8 x 7"	48	157	610	595
H-9883		18 x 16½ x 11"	10	118	525	510
H-1205WH	Set of 4 Lockable Casters			12	75	72

SPECIFY BIN COLOR: Blue, Red, Yellow, Green, Clear, White or Black SHIPS UNASSEMBLED VIA UPS

- Sturdy plastic bins with reinforced walls for added strength.
- Optional 5" polyurethane swivel casters add mobility.



H-9882  
With optional casters





## WIRE SHELF BIN ORGANIZERS

Attractive chrome organizer for small parts storage in labs, pharmacies and offices.

- Open wire design prevents dust buildup and maximizes airflow. NSF certified.
- Moisture-resistant plastic bins slide and hang for easy access to parts.
- Assemble in minutes. No tools or hardware required.
- Optional 5" polyurethane swivel casters add mobility.



H-8477

SPECIFY BIN COLOR: Blue, Red, Yellow, Green or Black

MODEL NO.	RACK SIZE W x D x H	BIN SIZE W x L x H	BINS/ RACK	WT. (LBS.)	PRICE EACH	
					1	2+
H-8476	36 x 12 x 72"	4 x 12 x 4"	88	126	\$495	\$470
H-8477		7 x 12 x 4"	55	119	470	445
H-8478	36 x 18 x 72"	4 x 18 x 4"	88	183	590	565
H-8479		7 x 18 x 4"	55	170	560	535
H-1205WH	Set of 4 Lockable Casters			12	75	72

SHIPS UNASSEMBLED VIA UPS

## VENTILATED STACK AND NEST CONTAINERS



Ventilated for easy drainage, cleaning and sanitizing. Stack when containers are full or nest when empty.

- Recommended for washing parts, harvesting produce and picking orders.
- Durable high-density polyethylene construction.

FDA COMPLIANT

SPECIFY COLOR: Blue or Green

MODEL NO.	DESCRIPTION	OUTSIDE DIM. L x W x H	CUBIC FT.	WT. (LBS.)	PRICE EACH (MIN. 3)		
					3	12	24+
S-24137	Ventilated	20 x 13 x 6"	0.6	2	\$17	\$16	\$15
S-24138		24 x 20 x 11"	1.8	5	28	26	24

## WIRE MESH BINS



100 lb. hanging capacity for storing heavy parts.

- Open wire provides visibility and prevents dust buildup.
- Chrome-plated steel resists bending and corrosion.
- Rear lip for hanging on louvered panels or rails.



Optional Dividers, see uline.com

SOLD IN CARTON QUANTITIES

MODEL NO.	DESCRIPTION	OUTSIDE DIM. L x W x H	QTY./ CTN.	LBS./ CTN.	PRICE PER BIN		
					1 CTN.	3 CTNS.	6+ CTNS.
S-24000	Wire Mesh	11 x 5½ x 5"	10	14	\$18	\$17	\$16
S-24001		15 x 8 x 7"	10	25	27	26	25
S-24613		18 x 16½ x 11"	5	20	47	45	43

## JUMBO RACK BINS

FOR 42" DEEP RACKS

Jumbo-sized to fit pallet racks. Store auto parts, hoses and apparel.

- Heavy-duty polypropylene construction with molded handles.
- 180 lb. stacking capacity. Anti-slide ledges keep bins steady.

Requires wire decking on racks

SPECIFY COLOR: Blue or Gray

MODEL NO.	DESCRIPTION	OUTSIDE DIM. L x W x H	QTY./ CTN.	WT. (LBS.)	PRICE PER BIN		
					1	4	8+
H-9998	Rack Bins	42 x 16½ x 17½"	1	20	\$130	\$125	\$120
H-9999		42 x 20 x 17½"			140	135	130
■H-10000		42 x 24 x 17½"			165	160	155

■ SHIPS VIA MOTOR FREIGHT



# CLOSED SHELF BIN ORGANIZERS

Super tough storage for your heaviest parts and industrial supplies.

- Side and back panels keep out dust and debris.
- Thick, polystyrene drawers are chemical resistant and virtually unbreakable.
- Rear tab allows drawers to safely hang open. Large front handle with room for labeling.
- Maintenance free, powder-coated steel frame won't rust or corrode.

SPECIFY DRAWER COLOR: Blue, Gray or Yellow

MODEL NO.	RACK SIZE W x D x H	DRAWER SIZE W x L x H	DRAWERS/ RACK	WT. (LBS.)	PRICE EACH	
					1	2+
H-4918	36 x 12 x 75"	4 x 12 x 5"	108	207	\$965	\$915
H-4919		6 x 12 x 5"	72	181	830	790
H-4920	36 x 18 x 75"	4 x 18 x 5"	108	269	1,245	1,185
H-4921		6 x 18 x 5"	72	247	1,095	1,040

SHIPS UNASSEMBLED VIA MOTOR FREIGHT

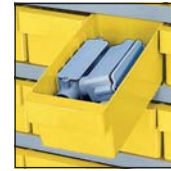

# MESH STRAIGHT WALL CONTAINERS

400 LB. CAPACITY

Reusable, ventilated containers for storage, shipping and parts washing.

- Mesh sides provide drainage, airflow and visibility.
- Fully cube out 48 x 40" pallets.

WITH MESH BOTTOM

SPECIFY COLOR: Gray or Red

MODEL NO.	INSIDE DIM. L x W x H	OUTSIDE DIM. L x W x H	CUBIC FT.	WT. (LBS.)	PRICE EACH (MIN. 3)		
					3	12	24+
S-20632	14 x 10 x 8"	16 x 12 x 8½"	0.9	2	\$21	\$20	\$19
S-20633	22 x 14 x 8"	24 x 16 x 8½"	1.8	3	27	26	25
S-20634	22 x 14 x 12"	24 x 16 x 12½"	2.7	4	31	30	29
S-20635	22 x 14 x 16"	24 x 16 x 16½"	3.6	5	34	33	32

WITH SOLID BOTTOM

Gray only

MODEL NO.	INSIDE DIM. L x W x H	OUTSIDE DIM. L x W x H	CUBIC FT.	WT. (LBS.)	PRICE EACH (MIN. 3)		
					3	12	24+
S-24711	14 x 10 x 8"	16 x 12 x 8½"	0.9	3	\$23	\$22	\$21
S-24712	22 x 14 x 8"	24 x 16 x 8½"	1.8	4	31	30	29
S-24713	22 x 14 x 12"	24 x 16 x 12½"	2.7	5	34	33	32
S-24714	22 x 14 x 16"	24 x 16 x 16½"	3.6	6	37	36	35



Solid Bottom – Contains wet and oily parts.

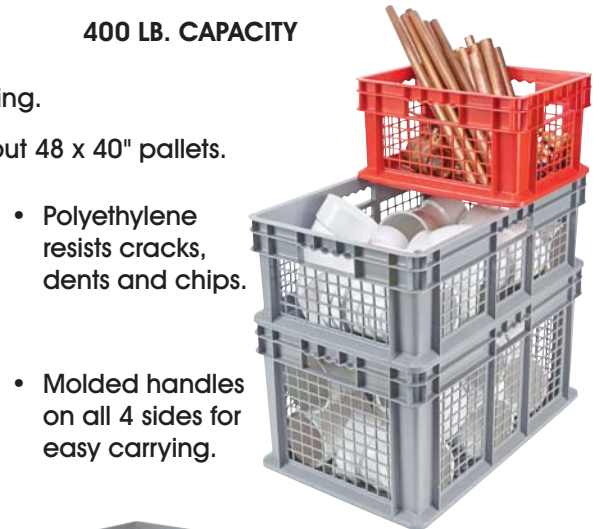

- Polyethylene resists cracks, dents and chips.
- Molded handles on all 4 sides for easy carrying.

# COLLAPSIBLE STRAIGHT WALL CONTAINER

700 LB. CAPACITY

Tough, reusable folding container for shipping, storage and work-in-process.

- Easily folds to 3" with fingertip latches to save space.
- Polyethylene resists cracks, dents and chips.
- Molded handles and drop-down access gates on both ends.



FINGERTIP LATCHES



DROP-DOWN ACCESS



COLLAPSED POSITION

MODEL NO.	INSIDE DIM. L x W x H	OUTSIDE DIM. L x W x H	CUBIC FT.	WT. (LBS.)	PRICE EACH (MIN. 3)		
					3	12	24+
S-21123	22 x 14 x 11"	24 x 16 x 12"	2.1	7	\$38	\$37	\$36



FULLY CUBE OUT 48 x 40"  
H-1449 PALLETS

# STACK AND NEST CONTAINERS



Ideal for order picking and short-term storage. Stack when containers are full or nest when empty.

- FDA compliant for direct food contact.
- Durable high-density construction.
- Lids keep container contents free from dust and dirt.
- Clear containers, see [uline.com](http://uline.com)

CONTAINERS				LIDS			MIN. ORDER 3			
MODEL NO.	INSIDE DIM. L x W x H	CUBIC FT.	WT. (LBS.)	PRICE EACH			MODEL NO.	WT. (LBS.)	PRICE EACH	
				3	12	24+			3	12+
S-14602	16 x 11 x 5"	0.6	2	\$15	\$14	\$13	S-14602L	1	\$10	\$9
S-14603	18 x 11 x 7"	1.1	3	18	17	16	S-14603L	1	10	9
S-10716	15 x 10 x 11"	1.3	4	20	18	17	S-10716L	1	10	9
S-11867	16 x 14 x 11"	1.8	5	27	25	24	S-11867L	1	11	10
S-10718	21 x 16 x 10"	2.1	6	29	27	26	S-10718L	2	13	12
S-10717	19 x 17 x 12"	2.7	7	30	28	27	S-10717L	2	14	13
S-19694	23 x 16 x 15"	3.7	9	42	40	38	S-19694L	4	17	16
S-14604	24 x 20 x 14"	4.7	11	49	47	45	-	-	-	-

SPECIFY COLOR: Blue, Red or Gray

# CROSS-STACK TUBS



HEAVY DUTY

Machine shops love these totes!

- Cross stacking at 90° allows identification and access.
- Notches secure stacked containers in place.
- Polypropylene construction. • Nest or stack.



Carts fit S-19504 tubs, sold separately

Carts – Durable aluminum. NSF certified. 5" polyurethane swivel casters.

FDA AND USDA COMPLIANT TUBS			SPECIFY TUB COLOR: Blue, Gray, Red, Yellow or White				
MODEL NO.	OUTSIDE DIM. L x W x H	CUBIC FT.	CAPACITY (LBS.)	WT. (LBS.)	PRICE EACH		
					3	12	24+
S-19502	18 x 11 x 8"	0.5	100	2	\$12	\$11	\$10
S-19503	24 x 17 x 8"	1.3		4	18	17	16
S-19504	25 x 16 x 9"	1.3		4	18	17	16
S-22694	24 x 17 x 12"	1.9		5	24	23	22
H-4874*	29 x 17 x 35" – 2 Tub Cart		450	14	\$205 each 2+ / \$200		
■H-7425	27 x 20 x 70" – 6 Tub Cart		600	22	\$225 each 2+ / \$215		

\* SHIPS ASSEMBLED VIA MOTOR FREIGHT

■ SHIPS UNASSEMBLED VIA MOTOR FREIGHT

# CLEAR INDUSTRIAL TOTES

See-through design lets you easily identify contents.

- From 230 to 700 lbs. of fabulous industrial stacking strength.



MODEL NO.	INSIDE DIMENSIONS L x W x H	CUBIC FT.	WT. (LBS.)	PRICE EACH (MIN. 3)		
				3	12	24+
S-19660	10.1 x 7.8 x 6.5"	0.3	2	\$21	\$20	\$19
S-13500	13.8 x 8.9 x 8.8"	0.6	3	25	24	23
S-17418	17.7 x 10.1 x 6"	0.7	3	29	28	27
S-20609	19.9 x 14.2 x 8.4"	1.4	5	32	31	30
S-11865	19.8 x 13.8 x 11.8"	1.8	7	33	32	31
S-11866	25.2 x 15.5 x 11"	2.3	8	44	43	42
S-12679	22.5 x 18 x 11.5"	2.7	9	46	45	44
S-23361	26 x 19 x 14"	4.0	13	68	66	64

# SPACE AGE TOTES

As lightweight as corrugated but with the durability of plastic. Holds up to 80 lbs.

- Steel reinforced; welded for strength, won't collapse. Nestable.
- Popular choice for mail and package handling and routing.
- Mail Trays available, see uline.com



SPECIFY COLOR: White, Blue, Black, Yellow, Red or Green

MODEL NO.	OUTSIDE DIM. L x W x H	WT. (LBS.)	PRICE EACH (MIN. 3)				BULK PACKS	
			3	12	24	48+	QTY.	PRICE EACH
S-132	18 x 13 x 6"	1	\$17	\$16	\$15	\$14	100	\$13
S-133	18 x 13 x 12"	2	\$14 each any quantity				100	13
S-2773	21 x 19 x 14"	3	30	28	26	24	100	22

# ROUND TRIP TOTES

Damage protection ensured. Stackable on pallets.

- Cube out trucks. • Tough plastic construction.
- Easily label for identification.
- Hinged, fold-over lid for easy stacking and nesting.



SPECIFY COLOR: Green, Gray, Red, Blue, Black or Yellow

MODEL NO.	INSIDE DIMENSIONS L x W x H	CUBIC FT.	WT. (LBS.)	PRICE EACH (MIN. 3)		
				3	12	24+
S-19665	10.1 x 7.8 x 6.5"	0.3	2	\$17	\$16	\$15
S-12676	13.8 x 8.9 x 8.8"	0.6	3	18	17	16
S-13499	17.7 x 10.1 x 6"	0.7	3	18	17	16
S-20588	19.9 x 14.2 x 8.4"	1.4	5	19	18	17
S-9744	19.8 x 13.8 x 11.8"	1.8	7	\$19 each any quantity		
S-14363	19.8 x 13.8 x 15.8"	2.2	7	23	22	21
S-9745	25.2 x 15.5 x 11"	2.3	8	28	27	26
S-9746	22.5 x 18 x 11.5"	2.7	9	31	30	29
S-20589	26 x 19 x 14"	4.0	13	51	49	47
■S-12677	28.7 x 20.8 x 18.8"	6.1	17	106	103	100

■ SHIPS VIA MOTOR FREIGHT

# TOTE DOLLIES



STEEL

Move up to 6 stacked totes at one time with ease.



PLASTIC

- Use with Round Trip Totes.
- 1" lip keeps totes secured.
- Steel – Sturdy 13-gauge stands up to heavy use. 4" polyurethane swivel casters.
- Plastic – Quiet operation, mover's choice. High corner supports hold totes in place. 4" rubber casters.

STEEL

MODEL NO.	DIMENSIONS L x W x H	FITS TOTE	LOAD CAP. (LBS.)	WT. (LBS.)	SHIPS ASSEMBLED VIA UPS	
					1	2+
H-3750	20 x 14 x 6"	S-9744	750	18	\$72	\$68
H-3751	22 x 18 x 6"	S-9746		21	82	76
H-3752	25 x 15 x 6"	S-9745		21	82	76
H-3753	26 x 19 x 6"	S-20589		23	93	88
H-3754	28 x 20 x 6"	S-12677		24	97	92

PLASTIC

SHIPS ASSEMBLED VIA UPS						
MODEL NO.	DIMENSIONS L x W x H	FITS TOTE	LOAD CAP. (LBS.)	WT. (LBS.)	1	2+
H-4912	26 x 19 x 11"	S-20589	750	17	\$140	\$135



## GIANT STACKABLE BINS



Pack and stack. Holds large, heavy and bulky products, parts and tools.

- Wide cut-out front opening for easy picking.
- Large easy-to-grip handles.
- Stable stacking up to 6 high on floor or shelf.

### COLORS

SPECIFY COLOR: Blue, Gray or Red

MODEL NO.	DESCRIPTION	OUTSIDE DIM. L x W x H	QTY./CTN.	LBS./CTN.	PRICE/BIN (SOLD IN CTN. QTYS.)	
					1	3+
S-11335	Giant Stackable Bins	15 x 20 x 12½"	3	13	\$22.30	\$21.65
S-12550		17½ x 10⅞ x 12½"	4	12	16.55	16.00
S-12551		17½ x 16½ x 12½"	2	8	24.15	23.50

### CLEAR

S-17886	Giant Stackable Bins	15 x 20 x 12½"	3	13	\$28.00	\$27.00
S-17887		17½ x 10⅞ x 12½"	4	12	20.40	19.85
S-17888		17½ x 16½ x 12½"	2	8	30.50	29.35

## MAGNUM HOPPER BINS

Transport, store and organize your largest and heaviest supplies and parts.

- Extra thick walls and wide ledges hold 150 lbs. for secure stacking.
- H-1878 and H-1879 – Rear molded handle and front bar for easy lifting.  
 H-1879 – Includes 3" swivel casters to roll your supplies right where you work.

### COLORS

SPECIFY COLOR: Yellow, Blue or Red



MODEL NO.	DESCRIPTION	OUTSIDE DIM. L x W x H	WT. (LBS.)	PRICE PER BIN		
				1	6	12+
H-2240	Magnum Bin	20 x 18 x 12"	7	\$49	\$47	\$45
H-3052		24 x 11 x 10"	6	37	35	33
H-3053		24 x 17 x 11"	8	52	49	47
H-1878		29 x 18 x 12"	10	72	69	66
H-1879	Bin w/ Casters	29 x 18 x 15"	14	106	103	100

### CLEAR

H-8820	Magnum Bin	24 x 17 x 11"	8	\$60	\$58	\$56
H-8821		29 x 18 x 12"	10	84	81	78

### BIN DIVIDERS

Black Only

MODEL NO.	FOR BINS L x H	QTY./PACK	LBS./PACK	PRICE PER PACK
H-2240D	20 x 12"	3	3	\$24
H-3052D	24 x 10"	2	3	24
H-3053D	24 x 11"	3	5	39



## HEAVY-DUTY STACK AND NEST CONTAINERS

Store your heaviest parts in harsh conditions. Holds up to 500 lbs.

- Tough fiberglass construction. Resists chemicals and oils.
- Withstands temperatures from -60° to 250°F.
- Stack when full or nest when empty. 3,000 lb. stacking strength.

SPECIFY COLOR: Blue, Gray or Red

MODEL NO.	OUTSIDE DIM. L x W x H	CAPACITY (LBS.)	CUBIC FT.	WT. (LBS.)	PRICE EACH (MIN. 3)		
					3	12	24+
S-19471	18 x 11 x 5"	500	0.5	3	\$24	\$23	\$22
S-19472	20 x 13 x 6"		0.7	4	27	26	25
S-19473	24 x 15 x 8"		1.3	7	37	35	34



# DIVIDER BOXES

Customize storage space with these dividable boxes.

- Use in stockrooms, assembly lines and repair shops.
- High-density polypropylene resists solvents and chemicals.
- Stackable. Flat panels to label contents.

**Clear** – Spot what you need quickly.

**Dividers** – Make compartments as small as 1¼" square. Sold separately. Available in Gray.

**Lids** – See-through lids protect contents from dust and dirt.



\* Maximum number of dividers used per box

COLORS	SPECIFY BIN COLOR: Blue, Red or Gray					SHORT DIVIDERS			LONG DIVIDERS		LIDS			
	MODEL NO.	INSIDE DIM. L x W x H	BINS/CTN.	LBS./CTN.	PRICE EA. (SOLD IN CTN. QTY.)		QTY./CTN.*	PRICE EA. (SOLD IN CTN. QTY.)		QTY./CTN.*	PRICE EA. (SOLD IN CTN. QTY.)		PRICE EACH	
					1	3+		1	3+		1	3+	1	8+
S-16975	9 x 6½ x 5"	20	23	\$8.05	\$7.35	7	\$1.20	\$1.15	5	\$1.45	\$1.35	\$6.05	\$5.55	
S-19495	15 x 9 x 3"	12	19	11.50	10.65	11	1.65	1.50	7	2.45	2.35	8.70	8.00	
S-16976	15 x 9 x 6"	8	15	13.75	12.65	11	2.15	2.05	7	2.60	2.45	8.70	8.00	
S-16977	15 x 9 x 8"	8	24	17.35	15.95	11	2.35	2.25	7	3.05	2.90	8.70	8.00	
S-22734	20 x 15 x 2½"	6	20	21.10	19.70	15	2.40	2.30	11	2.65	2.50	16.35	15.05	
S-19496	20 x 15 x 6"	3	13	23.90	22.00	15	2.85	2.70	11	3.05	2.90	16.35	15.05	
S-16978	20 x 15 x 8"	3	14	25.65	23.55	15	3.60	3.40	11	4.00	3.80	16.35	15.05	
S-16979	20 x 15 x 12"	3	16	33.85	31.35	15	6.80	6.40	11	7.45	7.00	16.35	15.05	

## CLEAR

S-19497	15 x 9 x 6"	8	15	\$16.50	\$15.25	11	\$2.15	\$2.05	7	\$2.60	\$2.45	\$8.70	\$8.00
S-19498	15 x 9 x 8"	8	24	20.70	19.05	11	2.35	2.25	7	3.05	2.90	8.70	8.00
S-23362	20 x 15 x 6"	3	13	27.65	25.25	15	2.85	2.70	11	3.05	2.90	16.35	15.05
S-19499	20 x 15 x 8"	3	14	30.70	28.20	15	3.60	3.40	11	4.00	3.80	16.35	15.05
S-22214	20 x 15 x 12"	3	16	40.55	37.25	15	6.80	6.40	11	7.45	7.00	16.35	15.05

# EGG FILLER FLATS

Excellent for holding small loose parts in repair shops or in your garage.

**Paper** – Industrial-strength board protects sharp edges and heavy items.

**Plastic** – Washable long-lasting storage for oily or dirty parts.

\* SPECIFY COLOR: Red or Yellow

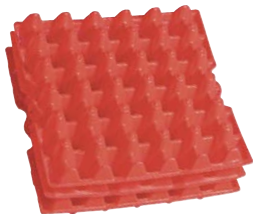

MODEL NO.	DESCRIPTION	SIZE W x L	QTY./BUNDLE	PRICE PER BUNDLE		
				1	5	10+
S-5189	Paper	12 x 12"	140	\$39	\$37	\$35
S-10735*	Plastic			89	86	82

# TOTE BOXES

**LIGHTWEIGHT**

"Airport style" totes. Pick and pack small parts or bus tables.

- Reinforced rim and handles.
- Round corners for easy cleaning.
- Commercial dishwasher safe.
- Polyethylene construction. Nestable.

NSF CERTIFIED

\* SPECIFY COLOR: Gray or White

MODEL NO.	OUTSIDE DIM. L x W x H	CUBIC FT.	CAPACITY (LBS.)	WT. (LBS.)	PRICE EACH (MIN. 3)		
					3	12	24+
S-19500*	20 x 15 x 5"	0.5	35	2	\$12	\$11	\$10
S-19501	22 x 17 x 7"	0.9	60	3	18	17	16



**RUBBERMAID®**

# CLEAR-VIEW CABINETS



48 x 24 x 78"

**Jumbo Heavy Duty**  
400 lb. shelf capacity.



36 x 24 x 72"

**Industrial**  
150 lb. shelf capacity.



36 x 18 x 72"

**Secure storage  
with full visibility**



36 x 18 x 42"

**Counter High**  
150 lb. shelf capacity.

- Recommended for doctors' offices, schools or hospitals.
- Shelves adjust in 2" increments.
- Clear acrylic panels.
- 3-point lock and reinforced steel doors.

SPECIFY COLOR: Tan, Gray or Black

MODEL NO.	DESCRIPTION	DIMENSIONS W x D x H	NO. OF SHELVES	SHELF CAP. (LBS.)	WT. (LBS.)	PRICE UNASSEMBLED		PRICE ASSEMBLED	
						1	2+	1	2+
H-2804	Counter High	36 x 18 x 42"	3	150	72	\$425	\$410	\$565	\$545
H-2805	Industrial	36 x 18 x 72"	5	150	125	615	590	775	750
H-3109		36 x 24 x 72"	5			675	650	855	825
H-3594	Jumbo Heavy Duty	48 x 24 x 78"	5	400	203	995	950	1,240	1,190

SHIPS VIA MOTOR FREIGHT



36 x 24 x 74"

## WELDED STORAGE CABINETS

Strength and security for storing your heavy tools and equipment.

- 14-gauge steel with durable powder-coat finish.
- Reinforced doors open on full-height hinges.
- Padlockable handle with three-point locking system.
- Shelves adjust in 2½" increments.

MODEL NO.	DESCRIPTION	DIMENSIONS W x D x H	NO. OF SHELVES	SHELF CAPACITY (LBS.)	WT. (LBS.)	PRICE EACH	
						1	2+
H-4458	Welded Industrial	36 x 18 x 74"	5	1,200	320	\$1,175	\$1,130
H-4459		36 x 24 x 74"				1,415	1,355
H-4460		48 x 24 x 74"				1,605	1,550

SHIPS ASSEMBLED VIA MOTOR FREIGHT



48 x 24 x 78"

## HEAVY-DUTY WELDED STORAGE CABINETS

Built like a tank. The ultimate cabinet for your heaviest motors and dies.

- Thick, 12-gauge steel with powder-coat finish.
- Bolt to floor for extra stability.
- Raised, forkliftable base for easy transporting.
- Padlockable handle.
- 14-gauge shelves hold almost a ton and adjust in 2½" increments.



MODEL NO.	DESCRIPTION	DIMENSIONS W x D x H	NO. OF SHELVES	SHELF CAPACITY (LBS.)	WT. (LBS.)	PRICE EACH	
						1	2+
H-7642	Welded Heavy Duty	36 x 24 x 78"	5	1,900	402	\$2,020	\$1,950
H-7643		48 x 24 x 78"				2,300	2,220

SHIPS ASSEMBLED VIA MOTOR FREIGHT



# STORAGE CABINETS

3 AND 5 SHELF



**Counter High**  
150 lb. shelf capacity.



**Industrial**  
150 lb. shelf capacity.



**Heavy Duty**  
200 lb. shelf capacity.



**Jumbo Heavy Duty**  
400 lb. shelf capacity.

Attractive enough for your office, tough enough for the warehouse.

- Heavy gauge steel construction.
- Locking doors.
- Adjustable shelves.

MODEL NO.	DESCRIPTION	DIMENSIONS W x D x H	NO. OF SHELVES	SHELF CAP. (LBS.)	WT. (LBS.)	SPECIFY COLOR: Tan, Gray or Black		ADDITIONAL SHELVES					
						PRICE UNASSEMBLED 1	PRICE UNASSEMBLED 2+	PRICE ASSEMBLED 1	PRICE ASSEMBLED 2+	MODEL NO.	WT. (LBS.)	PRICE EACH 1	PRICE EACH 4+
H-1106	Counter High	36 x 18 x 42"	3	150	70	\$265	\$255	\$380	\$365	H-1105ADD	8	\$25	\$24
H-3618		36 x 24 x 42"			78	330	320	425	410	H-1223ADD	9	36	34
H-3619		48 x 24 x 42"			115	505	480	675	650	H-1871ADD	12	46	43
H-8447	Industrial	30 x 18 x 72"	5	150	108	370	355	495	475	H-8447ADD	7	23	22
H-1105*		36 x 18 x 72"			113	415	400	535	510	H-1105ADD	8	25	24
H-2216		36 x 24 x 72"			124	470	450	625	600	H-1223ADD	9	36	34
H-2217	Heavy Duty	36 x 18 x 78"	5	200	142	515	490	665	640	H-1105ADD	8	25	24
H-1223		36 x 24 x 78"			157	565	540	755	725	H-1223ADD	9	36	34
H-3617	Jumbo Heavy Duty	48 x 18 x 78"	5	400	177	615	590	835	805	H-3617ADD	10	40	38
H-1871		48 x 24 x 78"			203	680	655	1,035	990	H-1871ADD	12	46	43

\*Also available in White

SHIPS VIA MOTOR FREIGHT

## STORAGE CABINET DOLLIES

SPECIFY COLOR: Tan, Gray or Black

MODEL NO.	FITS W x D	WT. (LBS.)	PRICE EACH		MODEL NO.	FITS W x D	WT. (LBS.)	PRICE EACH	
			1	2+				1	2+
H-8335	30 x 18"	19	\$77	\$74	H-3613	48 x 18"	35	\$98	\$94
H-2461	36 x 18"	22	82	78	H-2463	48 x 24"	39	107	102
H-2462	36 x 24"	25	94	90					

## STORAGE CABINET DOLLIES

Move cabinets with ease.

- 4" locking swivel casters.
- Sturdy steel frame. 1,000 lb. capacity.



## CHARGING CABINETS

Keep your scanners, radios and printers safe and fully charged.

- Lockable, welded steel cabinet with 32 center power outlets.
- Reinforced, clear-view doors with 3-point locking system.
- 8 (16 x 18") shelves on each side. Adjustable in 2" increments.
- Ventilated top and back prevent equipment from overheating.
- Center slide-out work shelf.

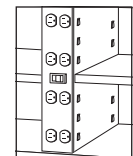

Plugs into standard outlet

MODEL NO.	DESCRIPTION	DIMENSIONS W x D x H	NO. OF SHELVES	SHELF CAP. (LBS.)	WT. (LBS.)	PRICE EACH	
						1	2+
H-8960	Standard	36 x 24 x 72"	16	50	235	\$1,475	\$1,375
H-8961	Mobile	36 x 24 x 78"			266	1,525	1,425

UL/C-UL Listed

SHIPS ASSEMBLED VIA MOTOR FREIGHT



## CLEAR-VIEW BIN STORAGE

Keep an eye on parts and supplies without opening the doors.

- Rugged, all-welded 16-gauge steel cabinet. Powder-coat finish.
- Plastic stackable bins easily adjust on rear louvered panel.
- 3-point locking doors with clear acrylic windows. Keys included.

**H-8480 and H-8482 –**  
Customize your own cabinet.  
Bins, see page 491.

**42 Bin Cabinet**  
(24) 11 x 5½ x 5"  
(12) 15 x 8 x 7"  
(6) 15 x 16½ x 7"

**48 Bin Cabinet**  
(24) 11 x 5½ x 5"  
(18) 15 x 8 x 7"  
(6) 15 x 16½ x 7"

SPECIFY BIN COLOR: Blue, Red, Green, White, Yellow, Clear or Black

MODEL NO.	DESCRIPTION	DIMENSIONS W x D x H	WT. (LBS.)	PRICE EACH	
				1	2+
H-8480	Empty Cabinet	36 x 24 x 78"	250	\$1,335	\$1,290
H-8481	42 Bin Cabinet		295	1,575	1,510
H-8482	Empty Cabinet	48 x 24 x 78"	315	1,615	1,565
H-8483	48 Bin Cabinet		377	1,865	1,805

SHIPS ASSEMBLED VIA MOTOR FREIGHT



## ACCESS CONTROL

Monitor and control access to safety supplies and valuable equipment.

- Logs up to 250 user IDs. Track access trail with included software.
- Keypad lock. Programmable time frames allow employee access only during shift.
- Rugged, 16-gauge steel construction. Clear-view doors.



**48 Bin Cabinet –** Bins hang and adjust on rear louvered panel.

**5 Shelf Cabinet –** Fits large items. Shelves adjust in 2" increments.

**48 Bin Cabinet**  
(24) 11 x 5½ x 5"  
(18) 15 x 8 x 7"  
(6) 15 x 16½ x 7"

\* SPECIFY BIN COLOR: Blue, Red, Green, White, Yellow, Clear or Black

MODEL NO.	DESCRIPTION	DIMENSIONS W x D x H	WT. (LBS.)	PRICE EACH	
				1	2+
H-9015*	48 Bin Cabinet	48 x 24 x 78"	350	\$2,865	\$2,765
H-9016	5 Shelf Cabinet		384	2,980	2,880

Requires 6 AA batteries, included

SHIPS ASSEMBLED VIA MOTOR FREIGHT



## VENTILATED STORAGE

Safely store and monitor pumps, motors and chemicals.

- Diamond-perforated doors for visibility and proper ventilation.
- Heavy-gauge steel construction. Durable gray powder-coat finish.
- Shelves adjust in 2" increments. • 3-point locking system. Includes 2 keys.

MODEL NO.	DESCRIPTION	DIMENSIONS W x D x H	WT. (LBS.)	PRICE EACH	
				1	2+
H-7808	5 Shelf Cabinet	36 x 18 x 72"	108	\$520	\$495
H-7814		36 x 24 x 72"	120	575	550
H-7815		48 x 24 x 78"	196	740	695

SHIPS UNASSEMBLED VIA MOTOR FREIGHT

# SPECIALTY CABINETS

## SLIM STORAGE



Compact cabinets utilize every inch when space is at a premium.

- Recommended for small offices, supply rooms and utility closets.
- Sturdy steel construction with attractive powder-coat finish.
- Shelves adjust in 2" increments. • Includes 2 keys.
- Recessed locking latch. No padlocks necessary.

SPECIFY COLOR: Black, Light Gray, Wine or White

MODEL NO.	NO. OF DOORS	DIMENSIONS W x D x H	NO. OF SHELVES	SHELF CAP. (LBS.)	WT. (LBS.)	PRICE EACH	
						1	2+
H-6316	1	18 x 18 x 66"			77	\$310	\$300
H-6317	2	24 x 18 x 66"	4	200	90	330	315
H-6318	2	30 x 15 x 66"			105	345	330

SHIPS UNASSEMBLED VIA MOTOR FREIGHT



## WARDROBE



Store work apparel and gear in the office or warehouse.

- Full-width top shelf. Garment bar holds 150 lbs.
- Heavy-gauge steel construction with powder-coat finish.
- Reinforced steel doors.
- 3-point locking system.

SPECIFY COLOR: Gray, Black or Tan

MODEL NO.	DIMENSIONS W x D x H	NO. OF SHELVES	SHELF CAP. (LBS.)	WT. (LBS.)	PRICE EACH	
					1	2+
H-3108	36 x 24 x 72"	2	150	112	\$400	\$385
H-5280	48 x 24 x 78"		300	165	635	610

SHIPS UNASSEMBLED VIA MOTOR FREIGHT

## JANITORIAL New

Keep cleaning supplies organized and out of sight.

- Full-height storage for brooms and mops.
- Welded steel construction with powder-coat finish.
- Bottom lipped shelf contains spills.
- Reinforced steel doors.
- 3-point locking system.



SPECIFY COLOR: Gray, Black or Tan

MODEL NO.	DIMENSIONS W x D x H	NO. OF SHELVES	SHELF CAP. (LBS.)	WT. (LBS.)	PRICE EACH	
					1	2+
H-10658	36 x 18 x 64"	4	75	85	\$635	\$615

SHIPS ASSEMBLED VIA MOTOR FREIGHT

## ELECTRONIC STORAGE

Protect high-value power tools, digital scales and batteries.

- Allow, prevent and track entry with keyless, digital security.
- Push-button keypad with key override. Resettable code.
- Shelves adjust in 2" increments.
- Heavy-gauge steel construction features locks in 2 places.



Push-button digital keypad lock.

Requires 4 AA batteries, included

SPECIFY COLOR: Gray or Black

MODEL NO.	DIMENSIONS W x D x H	NO. OF SHELVES	SHELF CAP. (LBS.)	WT. (LBS.)	PRICE EACH	
					1	2+
H-6312	36 x 18 x 72"		150	120	\$485	\$465
H-6313	36 x 24 x 78"	5	200	165	640	610
H-6314	48 x 24 x 78"		400	216	785	750

SHIPS UNASSEMBLED VIA MOTOR FREIGHT





# WALL-MOUNT CABINETS

Save space and protect your valuables.

- Recommended for schools, offices, stockrooms and repair shops.
- All-welded steel. Locking doors.
- Shelves adjust in 2" increments.
- 150 lb. shelf capacity.



## STANDARD

SPECIFY COLOR: Gray or Black

MODEL NO.	DIMENSIONS W x D x H	NO. OF DOORS	WT. (LBS.)	PRICE EACH	
				1	2+
H-4470	18 x 14 x 27"	1	48	\$270	\$260
■H-4471	30 x 14 x 27"	2	65	355	340
■H-4472	36 x 14 x 27"		81	385	370

Mounting hardware included

■ SHIPS ASSEMBLED VIA MOTOR FREIGHT

## CLEAR-VIEW

SPECIFY COLOR: Gray or Black

MODEL NO.	DIMENSIONS W x D x H	NO. OF DOORS	WT. (LBS.)	PRICE EACH	
				1	2+
H-5697	18 x 14 x 27"	1	48	\$335	\$320
■H-5698	30 x 14 x 27"	2	65	420	405
■H-5699	36 x 14 x 27"		81	445	430

Mounting hardware included

■ SHIPS ASSEMBLED VIA MOTOR FREIGHT

# WALL-MOUNT CABINET

## STAINLESS STEEL

Secure, overhead storage for restaurants, labs and doctors' offices.

- All-welded, type 304 stainless steel resists corrosion.
- Recessed locking handle.

MODEL NO.	DIMENSIONS W x D x H	NO. OF DOORS	WT. (LBS.)	PRICE EACH	
				1	2+
H-7591	30 x 12 x 30"	2	65	\$755	\$730

Mounting hardware included

SHIPS ASSEMBLED VIA MOTOR FREIGHT

- Shelves adjust in 2" increments.
- 150 lb. shelf capacity.



# UNDER COUNTER CABINETS



Maximize unused space under tables, desks and counters.

- Heavy-gauge steel construction. Locking doors.
- Shelf adjusts in 2" increments.
- 150 lb. shelf capacity.

SPECIFY COLOR: Gray or Black

MODEL NO.	DIMENSIONS W x D x H	NO. OF DOORS	WT. (LBS.)	PRICE EACH	
				1	2+
H-8529	36 x 18 x 30"	2	51	\$230	\$220
H-8530	36 x 18 x 36"		58	245	235
H-8531	36 x 24 x 36"		64	310	295

SHIPS UNASSEMBLED VIA MOTOR FREIGHT

# BRUTE® TOTES

## RUBBERMAID®

Move heavy tools and equipment between job sites.

- Industrial-grade polyethylene construction with reinforced bottom.
- Snap-tight lid keeps contents dry and secure.
- NSF certified.
- Strong, easy-grip handles.
- Stackable and nestable.

SOLD IN CARTON QUANTITIES

SPECIFY COLOR: Gray or White

MODEL NO.	OUTSIDE DIM. L x W x H	CAPACITY (GAL.)	QTY./ CARTON	LBS./ CARTON	PRICE PER TOTE	
					6	18+
S-22735	28 x 17 x 11"	14	6	36	\$37	\$35
S-22736	28 x 17 x 15"	20			43	40

SHIPS VIA MOTOR FREIGHT

# MOBILE STORAGE CABINETS

Cabinets roll easily for cleaning and rearranging workspace.

- Durable steel construction. Powder-coat finish.
- Shelves adjust in 2" increments. 3-point locking system.
- 4" locking swivel casters. • 750 lb. overall capacity.

**Standard** – Conceals contents for security and a clean look.

**Clear-View** – Clear acrylic panels for monitoring inventory.

- Assembled Cabinets, see [uline.com](http://uline.com)



## STANDARD

SPECIFY COLOR: Gray, Tan or Black

MODEL NO.	DIMENSIONS W x D x H	NO. OF SHELVES	SHELF CAP. (LBS.)	WT. (LBS.)	PRICE EACH	
					1	2+
H-7811	36 x 18 x 78"	5	150	135	\$490	\$475
H-8505	36 x 24 x 78"		150	164	545	525
H-9865	48 x 18 x 84"		400	238	690	665
H-7813	48 x 24 x 84"		400	242	755	730

SHIPS UNASSEMBLED VIA MOTOR FREIGHT

## CLEAR-VIEW

SPECIFY COLOR: Gray, Tan or Black

MODEL NO.	DIMENSIONS W x D x H	NO. OF SHELVES	SHELF CAP. (LBS.)	WT. (LBS.)	PRICE EACH	
					1	2+
H-9090	36 x 18 x 78"	5	150	147	\$690	\$665
H-9091	36 x 24 x 78"		150	179	750	725
H-9092	48 x 24 x 84"		400	242	1,070	1,025

SHIPS UNASSEMBLED VIA MOTOR FREIGHT

# DROP BOXES

## INDOOR

Give customers and staff a secure place to leave keys, mail and documents.

- 18-gauge steel. Locking front retrieval door.



**Standard** – Rear storage for pens and forms.

## OUTDOOR

Keep packages dry. For offices, apartment buildings and car rental agencies.

- 18-gauge galvanized steel. Locking front retrieval door.



**Standard** – Hinged lid covers top slot.



H-8557

**Mail** – Accepts overstuffed mailers and packages.

**Mail** – Top rain overhang and gasket seals.

MODEL NO.	DESCRIPTION	OVERALL DIM. W x D x H	SLOT OPENING	WT. (LBS.)	PRICE EACH	
					1	3+
H-3166	Standard	10 x 3 x 7"	9 x 1/4"	4	\$39	\$36
H-4253		12 x 5 x 15"	10 x 1/2"	7	55	51
■H-6305	Mail	21 x 12 x 36"	15 x 3 1/2"	50	290	275

■ SHIPS ASSEMBLED VIA MOTOR FREIGHT

MODEL NO.	DESCRIPTION	OVERALL DIM. W x D x H	SLOT OPENING	WT. (LBS.)	PRICE EACH	
					1	3+
H-6077	Standard	10 x 3 x 7"	9 x 1/4"	6	\$51	\$47
H-6078		12 x 5 x 15"	10 x 1/2"	12	73	67
■H-8557	Mail	21 x 16 x 36"	15 x 3 1/2"	79	345	325

■ SHIPS ASSEMBLED VIA MOTOR FREIGHT

# ULINE UTILITY TOTES

Use anywhere. Recommended for restaurants, airport security and assembly lines.

- Wide, comfortable handles. • Easy to clean and sanitize.
- Commercial dishwasher safe. • Sturdy polypropylene. Nestable.



NSF Certified

SPECIFY COLOR: Gray, Blue or Black

MODEL NO.	OUTSIDE DIM. L x W x H	CUBIC FT.	CAP. (LBS.)	WT. (LBS.)	PRICE EACH (MIN. 3)		
					3	12	24+
S-24008	20 x 15 x 5"	0.5	35	2	\$11	\$10	\$9
S-24009	22 x 17 x 7"	0.9	60	3	16	15	14



H-8323



H-6893

## GEAR LOCKERS

Vented storage for factory, warehouse and laboratory locker rooms.

- 16-gauge steel construction.
- Upper cabinet for valuables. Footlocker for shoes. Both padlockable.
- Upper shelf, full-width garment bar and 2 hooks.
- Ventilated sides for excellent airflow.

### OPEN

SPECIFY COLOR: Gray, Red or Blue

MODEL NO.	CONFIGURATION		NO. OF LOCKERS	DIMENSIONS W x D x H	PRICE EACH		WT. (LBS.)
					1	5+	
H-6893	Single Tier	1 Wide	1	24 x 18 x 72"	\$490	\$475	139
H-6894				24 x 24 x 72"	560	540	157

### WITH DOOR

SPECIFY COLOR: Gray, Red or Blue

MODEL NO.	CONFIGURATION		NO. OF LOCKERS	DIMENSIONS W x D x H	PRICE EACH		WT. (LBS.)
					1	5+	
H-8322	Single Tier	1 Wide	1	24 x 18 x 72"	\$620	\$600	163
H-8323				24 x 24 x 72"	695	670	182

For Padlocks, see pages 514-515

SHIPS UNASSEMBLED VIA MOTOR FREIGHT

**H-8322 and H-8323** – Padlockable door provides added security.

## BULK STORAGE LOCKERS

Secure storage for tenants, contractors and maintenance departments.

- Mount to wall or floor. Hardware included. Optional back for freestanding setup, see [uline.com](http://uline.com)
- Powder-coated steel construction. Ventilated mesh panels.

More sizes, see [uline.com](http://uline.com)

**Double Tier** – Two separate lockable openings.

**Add-On Units** – Attach to Starter Unit for continuous storage.



H-6897



H-6896



H-8324

### STARTER UNITS

### ADD-ON UNITS

MODEL NO.	CONFIGURATION		NO. OF LOCKERS	DIMENSIONS W x D x H	PRICE EACH		WT. (LBS.)	MODEL NO.	PRICE EACH		WT. (LBS.)
					1	2+			1	2+	
H-6896	Single Tier	1 Wide	1	36 x 36 x 90"	\$455	\$440	134	H-6896-ADD	\$350	\$335	95
H-8324				36 x 48 x 90"	585	560	144	H-8324-ADD	410	395	105
H-6897	Double Tier	1 Wide	2	36 x 36 x 90"	555	535	154	H-6897-ADD	435	420	115
H-8325				36 x 48 x 90"	705	675	185	H-8325-ADD	505	490	139

SHIPS UNASSEMBLED VIA MOTOR FREIGHT

## LOCKER ROOM BENCHES

Take a seat to change your clothes.

- Lacquered tops resist spills, warping and solvents.

**Standard** – For breakrooms and warehouses. 9" maple top. Powder-coated steel pedestals. Pre-drilled for easy mounting. Hardware included.

**Deluxe** – For country clubs and spas. 12" rich dark wood top. Solid aluminum pedestals. No mounting required.



8 FT. LONG



STANDARD



DELUXE

MODEL NO.	DIMENSIONS W x H	STANDARD – 1 1/4" THICK			DELUXE – 3" THICK		
		PRICE EACH		WT. (LBS.)	PRICE EACH		WT. (LBS.)
		1	3+		1	3+	
H-3640	36 x 17"	\$155	\$145	23	\$380	\$355	50
H-3009	48 x 17"	165	155	26	420	400	62
H-5554	60 x 17"	180	170	30	520	500	73
■H-3010	72 x 17"	195	185	34	565	540	84
■H-3011	96 x 17"	230	220	40	680	655	108

■ SHIPS UNASSEMBLED VIA MOTOR FREIGHT



# CLEAR-VIEW LOCKERS

Windows let you keep an eye on contents when security and theft risks are possible.

- Full-length piano hinge for long-lasting, secure use.
- Legs included – Add 6" to height.
- Double/Three Tier – Sturdy steel doors with clear polycarbonate windows. Three hooks per opening. Stainless steel recessed handles.
- Six Tier – Fully clear doors with convenient hasp handles.



SPECIFY COLOR: Tan or Gray

MODEL NO.	CONFIGURATION		NO. OF LOCKERS	DIMENSIONS W x D x H	PRICE UNASSEMBLED		PRICE ASSEMBLED		WT. (LBS.)
					1	2+	1	2+	
H-5551	Double Tier	3 Wide	6	36 x 18 x 72"	\$795	\$760	\$1,030	\$990	160
H-6953*	Three Tier	3 Wide	9	36 x 18 x 72"	910	875	1,185	1,145	170
H-5552	Six Tier	1 Wide	6	12 x 18 x 72"	350	335	465	450	61
H-5553		3 Wide	18	36 x 18 x 72"	915	880	1,190	1,150	144

\*One hook per opening

SHIPS VIA MOTOR FREIGHT

# ULINE ASSEMBLED LOCKERS

The convenience is worth every penny. Recommended for busy warehouses and factories.

- Solid steel construction. Works with most padlocks.
- Louvers allow air to circulate. • Legs included – Add 6" to height.
- Chrome-plated lift latch. Coat hooks included.
- Six Tier – Hasp handles provide simple, quiet operation.



\*Also available in Black

MODEL NO.	CONFIGURATION		NO. OF LOCKERS	DIMENSIONS W x D x H	PRICE ASSEMBLED		WT. (LBS.)
					1	2+	
H-9866	Single Tier	3 Wide	3	36 x 12 x 72"	\$695	\$675	135
H-8998				36 x 18 x 72"	725	705	142
H-8485	Double Tier	3 Wide	6	36 x 12 x 72"	715	695	131
H-7576*				36 x 18 x 72"	745	725	143
H-8486	Three Tier	3 Wide	9	36 x 12 x 72"	835	815	145
H-7577*				36 x 18 x 72"	870	845	157
H-9867	Six Tier	3 Wide	18	36 x 12 x 72"	890	860	146
H-7578				36 x 18 x 72"	920	890	153

SHIPS VIA MOTOR FREIGHT



# ULINE DELUXE LOCKERS

ASSEMBLED

The Hulk's locker! Withstands the punishment in schools and factories.

- Ultra-quiet, reinforced doors. Heavy-gauge steel construction.
- Louvers allow air to circulate. • Legs included – Add 6" to height.
- Double/Three Tier – Stainless steel recessed handles provide added security. Coat hooks included.
- Six Tier – Hasp handles provide simple, quiet operation.



RECESSED



HASP

MODEL NO.	CONFIGURATION		NO. OF LOCKERS	DIMENSIONS W x D x H	PRICE ASSEMBLED		WT. (LBS.)
					1	2+	
H-8487	Double Tier	3 Wide	6	36 x 18 x 72"	\$1,235	\$1,185	254
H-8488	Three Tier		9		1,345	1,295	266
H-8489	Six Tier		18		1,465	1,405	279

SHIPS VIA MOTOR FREIGHT



**SINGLE TIER  
3 WIDE**

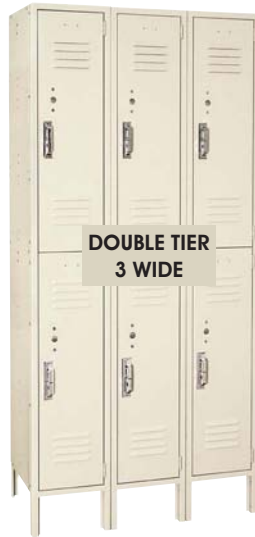

**DOUBLE TIER  
3 WIDE**



**SIX TIER  
3 WIDE**



**SIX TIER  
16-PERSON LOCKER**

H-6185 – Includes hanging bar for uniforms and coats.

SPECIFY COLOR:  Tan  Gray

MODEL NO.	CONFIGURATION	NO. OF LOCKERS	DIMENSIONS W x D x H	PRICE UNASSEMBLED		WT. (LBS.)	
				1	2+		
H-7584*	Single Tier	1 Wide	1	12 x 18 x 72"	\$205	\$195	50
H-4807*		3 Wide	3	36 x 12 x 72"	475	460	128
H-4289*				36 x 18 x 72"	495	480	139
H-6742*				45 x 18 x 72"	550	535	153
H-6743*	Double Tier	1 Wide	2	12 x 18 x 72"	210	200	54
H-4808*		3 Wide	6	36 x 12 x 72"	495	480	131
H-4290*				36 x 18 x 72"	515	500	143
H-6744*				45 x 18 x 72"	565	550	157
H-8342*	Three Tier	1 Wide	3	12 x 12 x 72"	215	205	50
H-7585*				12 x 18 x 72"	225	215	59
H-5548*		3 Wide	9	36 x 12 x 72"	525	510	145
H-5549*			36 x 18 x 72"	565	550	155	
H-7586*			45 x 18 x 72"	640	615	173	
H-8343	Four Tier	3 Wide	12	36 x 18 x 72"	605	585	154
H-6745	Six Tier	1 Wide	6	12 x 18 x 72"	220	210	66
H-4809		3 Wide	18	36 x 12 x 72"	520	505	141
H-4291				36 x 18 x 72"	555	540	153
H-6185	Six Tier	16-Person Locker	16	72 x 18 x 72"	605	585	164

\* Includes 3 coat hooks per locker

SHIPS VIA MOTOR FREIGHT

Easy-to-open lockers. Recommended for breakrooms, changing rooms and coat closets.

- Smooth sliding, chrome-plated lift latch.
- Solid steel construction. Works with most locks.
- Four and Six Tier – Hasp handles provide simple, quiet operation.
- Legs included – Add 6" to height.
- Louvers allow air to circulate.



**THREE TIER  
3 WIDE**



**FOUR TIER  
3 WIDE**

**LOCKS,**  
see pages 514-515



## STACKABLE CUBE LOCKERS

Add lockers as you add employees. Easy to configure for any warehouse or fitness center.

- Lockers connect top-to-bottom and side-to-side.



SPECIFY COLOR:  Black  Blue  Gray

MODEL NO.	CONFIGURATION	NO. OF LOCKERS	DIMENSIONS W x D x H	PRICE EACH		WT. (LBS.)	
				1	6+		
H-7587	Single Tier	1 Wide	1	12 x 12 x 12"	\$80	\$75	12
H-7588					12 x 18 x 12"	90	85

Mounting hardware included

SHIPS UNASSEMBLED VIA UPS

- Stack on floor or mount to wall.
- Convenient hasp handle. Padlockable.



# ULINE INDUSTRIAL LOCKERS



**SINGLE TIER  
3 WIDE**



**DOUBLE TIER  
3 WIDE**



**SIX TIER  
1 WIDE**



**SIX TIER  
3 WIDE**



**H-2489** – Includes hanging bar for full-length garments.

Safe, secure personal storage.

- Reinforced doors withstand abuse.
- Single/Double Tier – Smooth, quiet, recessed handle for safety and security.
- Solid steel construction.
- Legs included – Add 6" to height.
- Louvers allow air to circulate.



- 15" width for large duffel bags and work boots.

Base plates and sloping tops available on [uline.com](http://uline.com)

## STANDARD

SPECIFY COLOR:  Tan  Gray

MODEL NO.	CONFIGURATION		NO. OF LOCKERS	DIMENSIONS W x D x H	PRICE UNASSEMBLED		PRICE ASSEMBLED		WT. (LBS.)
					1	2+	1	2+	
H-1226*	Single Tier	1 Wide	1	12 x 18 x 72"	\$254	\$242	\$322	\$306	63
H-5528*		3 Wide	3	15 x 18 x 72"	290	276	363	346	70
H-3637*	Single Tier	3 Wide	3	36 x 12 x 72"	596	569	709	679	147
H-1227*				36 x 18 x 72"	625	597	754	720	160
H-5529*				45 x 18 x 72"	715	682	835	798	175
H-1224*	Double Tier	1 Wide	2	12 x 18 x 72"	271	257	341	325	64
H-5532*		3 Wide	6	15 x 18 x 72"	304	289	381	363	71
H-3638*	Double Tier	3 Wide	6	36 x 12 x 72"	650	618	765	729	147
H-1225*				36 x 18 x 72"	674	642	809	772	169
H-5533*				45 x 18 x 72"	755	721	904	864	180
H-6735	Six Tier	1 Wide	6	12 x 12 x 72"	288	274	361	343	52
H-1845		12 x 18 x 72"	313	299	389	371	61		
H-3639	Six Tier	3 Wide	18	36 x 12 x 72"	683	653	896	854	147
H-1393				36 x 18 x 72"	734	700	970	925	173
H-2489	Six Tier	16-Person Locker	16	72 x 18 x 72"	776	739	1,151	1,099	179

\* Includes 3 coat hooks per locker

SHIPS VIA MOTOR FREIGHT

## VENTILATED



Store uniforms, gym clothes and your gear.

- See-through vents provide excellent airflow and visibility.
- Single Tier has top shelf.

## VENTILATED

Gray only

MODEL NO.	CONFIGURATION		NO. OF LOCKERS	DIMENSIONS W x D x H	PRICE UNASSEMBLED		PRICE ASSEMBLED		WT. (LBS.)
					1	2+	1	2+	
H-3159*	Single Tier	1 Wide	1	12 x 18 x 72"	N/A	N/A	\$440	\$420	78
H-3160*		3 Wide	3	36 x 18 x 72"	N/A	N/A	1,020	970	207
H-3161*	Double Tier	1 Wide	2	12 x 18 x 72"	N/A	N/A	465	445	80
H-3162*		3 Wide	6	36 x 18 x 72"	N/A	N/A	1,115	1,065	209
H-3163	Six Tier	1 Wide	6	12 x 18 x 72"	N/A	N/A	565	540	96
H-3164		3 Wide	18	36 x 18 x 72"	N/A	N/A	1,320	1,260	259

\* Includes 3 coat hooks per locker

SHIPS VIA MOTOR FREIGHT



# ULINE PADLOCKS



H-7437



H-7438

## COMBINATION

Reliable and secure. For storage lockers and sheds.

- Stainless steel body.
- H-7438** – Features optional key override.

## STEEL

Indoor/outdoor. Use to keep equipment and property secure.

- Laminated steel body.
- 2" and 2½" shackles** – Extra length for long-handle hasps.



H-7440

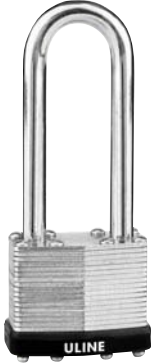

H-7441

## HEAVY DUTY STEEL

Commercial grade. For cargo doors and storage containers.

- **33% thicker shackle.** Extra-large steel body. Top and bottom bumpers.
- Indoor/outdoor.



H-9837



H-9838

## COMBINATION

\* Master Key sold separately

MODEL NO.	DESCRIPTION	INSIDE SHACKLE		PRICE EACH (MIN. 3)	
		HEIGHT	WIDTH	3	12+
H-7437	Combination	3/4"	13/16"	\$6	\$5
H-7438*	Combination w/ Key Master Key for H-7438	3/4"	13/16"	8	7
H-7439				3	N/A

SPECIFY DIAL COLOR: Black or Blue

## STEEL

MODEL NO.	DESCRIPTION	HEIGHT	WIDTH	3	12+
H-7440	Keyed – Alike	7/8"	3/4"	\$7	\$6
H-8340		1½"	3/4"	8	7
H-8341	One key opens a whole set of locks.	2"	5/8"	8	7
H-7441		2½"	3/4"	9	8

## HEAVY DUTY STEEL

MODEL NO.	DESCRIPTION	HEIGHT	WIDTH	3	12+
H-9837	Keyed – Alike	1"	1"	\$13	\$12
H-9838		2½"	1"	15	14



# KEY LOCK BOXES

Controls access at construction sites or rental properties.

- Metal body holds up to 15 keys.
- 4-digit resettable combination. Sliding cover.

**Hanging** – Rubber-coated shackle hangs on doorknobs.

MODEL NO.	DESCRIPTION	DIMENSIONS W x D x H	INSIDE SHACKLE		PRICE EACH	
			HEIGHT	WIDTH	1	6+
H-5662	Hanging	3 x 1¼ x 7"	1½"	1½"	\$34	\$32
H-9880	Wall-Mount	3 x 1½ x 5"	N/A	N/A	47	45

**Wall-Mount** – Mount to wall, post or fence.



# STAINLESS PADLOCKS

Rustproof guaranteed. Stands up to the snow and salt of Chicago winters.

- For outdoor sheds, gates and trailers.
- Type 304 stainless steel case and shackle.
- Shackle resists cutting.



H-9835



H-9836

MODEL NO.	DESCRIPTION	INSIDE SHACKLE		PRICE EACH (MIN. 3)	
		HEIGHT	WIDTH	3	12+
H-9835	Keyed – Alike	1"	1"	\$36	\$34
H-9836		2½"	1"	38	36

# BRASS PADLOCKS

Reliable and secure in harsh, humid outdoor environments.

- For boat trailers, dock boxes and job site storage.
- Hardened shackle resists cutting.
- 4 digits offer up to 10,000 combinations. Keyless reset.

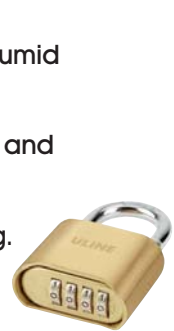

H-9820



H-9821

MODEL NO.	DESCRIPTION	INSIDE SHACKLE		PRICE EACH (MIN. 3)	
		HEIGHT	WIDTH	3	12+
H-9820	Combination	1"	1"	\$19	\$18
H-9821		2¼"	1"	21	20

# CABLE LOCK

The lock for all trades. Secure gates, ladders and toolboxes.

- Cut-resistant, **1/2" braided steel cable** with vinyl coating.
- Durable aluminum lock body.
- Adjusts up to 7' for wrapping and cinching bulky items.



MODEL NO.	DESCRIPTION	CABLE		PRICE EACH	
		LENGTH	DIAM.	1	4+
H-9822	Keyed – Alike	7'	1/2"	\$38	\$36

# MASTER LOCK® PADLOCKS

## OUTDOOR

Built tough for outdoor use. For substations and semi-trailers.

- Impact and weather-resistant cover protects against water, ice and dirt.
- Heavy-duty steel body.
- Hardened steel shackle resists prying, cutting and sawing.



H-4852

H-7800

MODEL NO.	DESCRIPTION	INSIDE SHACKLE		PRICE EACH (MIN. 3)	
		HEIGHT	WIDTH	3	12+
H-4852	Keyed - Alike	1 1/8"	7/8"	\$28	\$27
H-7800		2 1/2"		31	30
H-4853	Keyed - Different	1 1/8"		27	26

## RESETTABLE COMBO

Secure the gates on your 40-acre ranch.

- Reset to any of 10,000 combinations.
- Heavy-duty die-cast body. Powder coated.
- Hardened steel shackle resists prying, cutting and sawing.



MODEL NO.	DESCRIPTION	INSIDE SHACKLE		PRICE EACH (MIN. 3)	
		HEIGHT	WIDTH	3	12+
H-7801	Resettable Combo	1"	1"	\$16	\$15

## BRASS

Solid brass case ensures long wear, even outdoors.

- For storerooms and security gates.
- Hardened steel shackle resists prying, cutting and sawing.

**Combination** – 4 digits offer up to 10,000 combinations.

**Keyed Alike** – Quick access. Boron alloy shackle.



MODEL NO.	DESCRIPTION	INSIDE SHACKLE		PRICE EACH (MIN. 3)	
		HEIGHT	WIDTH	3	12+
H-2916	Combination	1"	1"	\$25	\$24
H-4658		2 1/4"		27	26
H-6718	Keyed - Alike	1 3/16"	15/16"	28	27
H-6719		2 3/16"		30	29

## COMBINATION

Protection for school, gym and employee lockers.

**H-2061** – Features optional key override for alternative access.



H-2061

H-1391

## STEEL

Industrial grade for self-storage units and tool sheds.

2", 2 1/2" and 5 3/4" shackles – Extra length fits long-handle hasps and larger chains.

- Indoor/outdoor.



H-4475

H-2491

## HEAVY DUTY STEEL

Strongest protection for gates and job boxes.

- Extra wide, boron alloy shackle resists drilling and sawing.
- Indoor/outdoor.



H-5668

H-5669

## COMBINATION

\* Master Key sold separately

MODEL NO.	DESCRIPTION	INSIDE SHACKLE		PRICE EACH (MIN. 3)	
		HEIGHT	WIDTH	3	12+
H-1391	Combination	3/4"	13/16"	\$10	\$9
H-2061*	Combination w/ Key Master Key for H-2061	3/4"	13/16"	11	10
H-2062				9	N/A

## STEEL

H-1632		3/4"	5/8"	\$12	\$11
H-5664	Keyed - Alike	15/16"	3/4"	14	13
H-2491				15	14
H-5665	One key opens a whole set of locks.	2 1/2"	3/4"	16	15
H-4475				19	18
H-1392		3/4"	5/8"	11	10
H-5666	Keyed - Different	15/16"	3/4"	13	12
H-2492				14	13
H-5667	Each lock has its own specific key.	2 1/2"	3/4"	15	14
H-4476				18	17

## HEAVY DUTY STEEL

H-5668	Keyed - Alike	1"	15/16"	\$18	\$17
H-5669				20	19



S-21122

## TIP-OUT BINS

Modular small parts storage for warehouses, workshops and retail display.

- Clear plastic bins tip out 45° for easy access. Removable for cleaning.
- Polystyrene cabinets can be stacked and wall mounted.
- Molded-in handles with label holders.
- Additional sizes, see [uline.com](http://uline.com)

### COMBO UNIT

MODEL NO.	OVERALL DIM. W x D x H	BIN QTY.	INSIDE BIN DIM. W x D x H	WT. (LBS.)	PRICE EACH	
					1	3+
S-21122	24 x 6½ x 19"	15	(6) 3½ x 2½ x 2¾" (5) 3½ x 3½ x 4¼" (4) 5 x 5 x 5¼"	12	\$104	\$99



MODEL NO.	OVERALL DIM. W x D x H	BIN QTY.	INSIDE BIN DIM. W x D x H	WT. (LBS.)	PRICE EACH	
					1	3+
S-21119	24 x 3½ x 4½"	6	3½ x 2½ x 2¾"	2	\$24	\$23
S-21120	24 x 5½ x 6½"	5	3½ x 3½ x 4¼"	4	34	33
S-21121	24 x 6½ x 8½"	4	5 x 5 x 5¼"	6	50	48

## STEEL PARTS CABINETS



Store parts and supplies, from nuts and bolts to batteries and casters.

- Tough steel cabinets and durable plastic drawers with clear windows.
- Two removable plastic dividers per drawer included. Stackable and wall mountable.

MODEL NO.	NO. OF DRAWERS	DIMENSIONS W x D x H	DRAWER DIM. W x D x H	WT. (LBS.)	PRICE EACH
H-1522	9	17 x 11 x 11"	5 x 10 x 3"	18	\$145
H-3898	28	17 x 11 x 11"	2 x 10 x 2"	21	150

SHIPS ASSEMBLED VIA UPS

## PLASTIC PARTS CABINETS



Organize screws, fasteners and small, lightweight parts.

- Durable plastic cabinets with clear drawers.
- Includes 8 small and 4 large drawer dividers.
- Stack on workbench or mount to wall.

SPECIFY COLOR: Red or Black

MODEL NO.	NO. OF DRAWERS	DIMENSIONS W x D x H	DRAWER DIM. W x D x H	WT. (LBS.)	PRICE EACH
H-5578	26	20 x 7 x 11"	(20) 2 x 5 x 1" (6) 4 x 5 x 2"	5	\$34
H-5579	44	20 x 7 x 16"	(32) 2 x 5 x 1" (12) 4 x 5 x 2"	7	45

SHIPS ASSEMBLED VIA UPS

## ULINE MIGHTY TOTES New



Transport power tools, cords and samples.

- Recommended for job sites, trade shows and warehouses.
- Recessed lid for superior stacking support.
- Thick, durable reinforced polypropylene.
- Slotted lid for tie-down straps or locks.

MADE IN USA

SOLD IN CARTON QUANTITIES

MODEL NO.	OUTSIDE DIMENSIONS L x W x H	CAPACITY (GAL.)	QTY./ CTN.	LBS./ CTN.	PRICE PER TOTE	
					1 CTN.	3+ CTNS.
S-24943	26 x 18 x 12"	17	6	30	\$20	\$19
S-24944	29 x 20 x 15"	27	4	31	24	23

SHIPS VIA MOTOR FREIGHT

## JUMBO TOTE WITH WHEELS



Haul contractor tools, trade show supplies and sports equipment.

- Reinforced polypropylene construction with large pull handle.
- Stackable and nestable.
- Two 4" wheels on metal axle roll over uneven ground.
- Slotted lid for tie-down straps or locks.

STERILITE®

MODEL NO.	OUTSIDE DIMENSIONS L x W x H	CAPACITY (GAL.)	QTY./ CTN.	LBS./ CTN.	PRICE PER CARTON	
					1	3+
S-24868	37 x 21 x 18"	40	2	22	\$100	\$95

SHIPS VIA MOTOR FREIGHT



# KEY CABINETS



Control access to loaned keys.

- Heavy duty 22-gauge welded-steel cabinet.
- Includes "Out key" tags to identify who has keys.
- Numbered tag key holders easily identify keys.
- Additional Tags and information, see [uline.com](http://uline.com)

## LOCK STYLES

**Keyed** – Reliable security.

**Combination** – No keys to lose.

**Digital** – Programmable for added security.

**Dual Lock Keyed** – Requires two people to unlock.



MODEL NO.	KEYS	LOCK STYLE	DIMENSIONS W x D x H	PRICE EACH	
				1	3+
H-1447	30	Keyed	8 x 3 x 12"	\$82	\$78
H-1448	60		13 x 3 x 17"	115	110
H-2063	120		13 x 3 x 17"	140	135
H-3165	240	Keyed	17 x 5 x 20"	255	245
H-5329	330		17 x 5 x 20"	275	265
H-5645	500		18 x 6 x 25"	390	375
H-8972	30	Dual Lock Keyed	8 x 3 x 12"	70	65
H-8973	60		13 x 3 x 17"	100	95

MODEL NO.	KEYS	LOCK STYLE	DIMENSIONS W x D x H	PRICE EACH	
				1	3+
H-5646	30	Combination	8 x 3 x 12"	\$155	\$150
H-2931	65		13 x 3 x 17"	180	175
H-6264	120		13 x 3 x 17"	210	200
H-7765	240		17 x 5 x 20"	335	320
H-2932	65		Digital	13 x 3 x 17"	290
H-6265	120	13 x 3 x 17"		345	330
H-7766	240	17 x 5 x 20"		475	455
S-11934	Blank Replacement Tags – Pkg. of 20			8.90	8.50

# DEPOSITORY SAFES

Keep your cash safe. Anti-theft deposit hopper allows money in, but not out.

- Fits under counters at retail shops, convenience stores, bars and restaurants.
- Programmable keypad lock allows you to easily add or remove user access.

Floor mounting hardware included

MODEL NO.	DESCRIPTION	OVERALL DIM. W x D x H	CUBIC FT.	WT. (LBS.)	PRICE EACH	
					1	3+
H-7767	Depository	14 x 16 x 20"	0.9	92	\$730	\$705
H-7768		14 x 16 x 27"	1.6	121	835	810

- Heavy-gauge steel construction. Drill-resistant door with multiple locking bolts.

**H-7768** – Includes removable, adjustable shelf.



SHIPS ASSEMBLED VIA MOTOR FREIGHT

# DIGITAL SAFES

Secure cash, documents, jewelry and other valuables.

- For offices, shops and hotels.
- Heavy-gauge steel body and door.
- Fire rated at 1,400°F for 30 minutes.
- Keypad lock with key override.



**Standard** – Secures to wall or floor. 2 locking bolts. H-8938 is fire rated.

**Floor** – Larger size for office or receiving desk. Adjustable shelves.



\* Not fire rated

MODEL NO.	DESCRIPTION	OVERALL DIM. W x D x H	CUBIC FT.	WT. (LBS.)	PRICE EACH	
					1	3+
H-8937*	Standard	14 x 10 x 10"	0.6	21	\$125	\$120
H-8938		15 x 13 x 12"	0.8	49	250	240
■ H-8939	Floor	21 x 20 x 29"	4.0	165	645	625
■ H-8940		21 x 23 x 40"	5.7	217	800	775

Mounting hardware included

SHIPS ASSEMBLED VIA MOTOR FREIGHT

# JUMBO PACKING TABLES

INDUSTRIAL



Huge workspace. Work from both sides in shipping departments and assembly areas.

- All tables hold up to 500 lbs.
- Adjustable steel legs 30 to 37".
- Full depth bottom shelf for storage.



COMPOSITE WOOD TOP  
LAMINATE TOP  
MAPLE TOP

SHIPS UNASSEMBLED VIA MOTOR FREIGHT

MODEL NO.	DIMENSIONS L x W	COMPOSITE WOOD			LAMINATE			MAPLE*		
		PRICE EACH	WT. (LBS.)	WT. (LBS.)	PRICE EACH	WT. (LBS.)	WT. (LBS.)	PRICE EACH	WT. (LBS.)	WT. (LBS.)
H-4988	72 x 48"	\$645	\$620	297	\$685	\$655	262	\$940	\$915	274
H-4989	96 x 48"	850	825	386	910	880	352	1,230	1,190	366

\* Top ships in two pieces

## PACKING TABLE ACCESSORIES



### DRAWERS

Mount to underside of workbench.

- Includes mounting hardware.
- Cam lock with two keys.
- H-1550 features removable tray.

SHIPS VIA UPS

MODEL NO.	DIMENSIONS L x W x H	WT. (LBS.)	PRICE EACH
H-1550	18 x 15 x 8"	23	\$110
H-4833	25 x 22 x 6"	28	125

SHIPS VIA UPS

MODEL NO.	DESCRIPTION	TABLE WIDTH	PRICE/SET
H-6883		24"	\$85
H-6884	4 Casters	30"	87
H-6885		36, 48"	89
H-6886	6 Casters	30"	126
H-6887		36, 48"	130



### TABLE CASTERS

Add mobility to Packing Tables.

- Includes lockable swivel casters and crossbars.
- 96" tables require 6 casters.



SHIPS VIA MOTOR FREIGHT

MODEL NO.	DIMENSIONS L x W	WT. (LBS.)	PRICE EACH
H-3658	48 x 10"	30	\$225
H-3659	60 x 10"	34	235
H-3660	72 x 10"	38	240
H-3661	96 x 10"	46	280

UL/C-UL Listed

### ELECTRIC TOP SHELF

Keep your power tools close at hand.

- 12" height. 16-gauge steel.
- Includes 8 pre-wired outlets.
- 100 lb. load capacity.
- Stackable up to 2 high.

### TOP SHELF

Reduce tabletop clutter.

- 12" height. 16-gauge steel.
- 1½" raised back lip.
- 200 lb. capacity.
- Stackable up to 2 high.



SHIPS VIA MOTOR FREIGHT

MODEL NO.	DIMENSIONS L x W	WT. (LBS.)	PRICE EACH
H-5503	48 x 10"	19	\$70
H-5504	60 x 10"	21	80
H-5505	72 x 10"	24	95
H-5506	96 x 10"	32	120



Deluxe Mesh

Mesh

## MESH WORK STOOLS

Ventilated mesh back helps you keep your cool.

- Padded, adjustable armrests.
- Adjustable seat height and footring.
- Mesh upholstered fabric seat.
- Optional casters provide mobility.

**Deluxe Mesh** – 4" thick molded foam seat. Oversized seat and backrest with adjustable lumbar support.

**Mesh** – 3½" thick molded foam seat. Chrome footring.

### DELUXE MESH

EASY ASSEMBLY. SHIPS VIA UPS.

MODEL NO.	SEAT DIMENSIONS W x D	CAP. (LBS.)	ADJUSTABLE HEIGHT	WT. (LBS.)	PRICE EACH	
					1	3+
H-6890	21 x 19"	300	27-37"	38	\$305	\$295
H-1375WH	Set of Five Casters – Optional			2	18	16

### MESH

EASY ASSEMBLY. SHIPS VIA UPS.

MODEL NO.	SEAT DIMENSIONS W x D	CAP. (LBS.)	ADJUSTABLE HEIGHT	WT. (LBS.)	PRICE EACH	
					1	3+
H-5498	19 x 17"	300	24-34"	33	\$250	\$240
H-1375WH	Set of Five Casters – Optional			2	18	16

# INDUSTRIAL PACKING TABLES

Customize your work area.

- All tables hold up to 500 lbs.
- 14" bottom shelf for additional storage.
- Adjustable steel legs: 30 to 37".
- Replacement table tops and leg height extenders available, see [uline.com](http://uline.com)
- **Stainless Steel Top** – Type 304 surface for labs and food service. Wood core.
- Ships unassembled via motor freight.



**COMPOSITE WOOD TOP WITH ROUNDED EDGE.**  
1½" Thickness

MODEL NO.	DIMENSIONS L x W	PRICE EACH		WT. (LBS.)
		1	2+	
H-6863	48 x 24"	\$290	\$280	115
H-1128	48 x 30"	315	300	130
H-3657	48 x 36"	330	315	145
H-6864	60 x 24"	305	290	136
H-1135	60 x 30"	330	315	158
H-1136	60 x 36"	370	350	180
H-1137	72 x 30"	370	350	178
H-1138	72 x 36"	415	400	207
H-2484	96 x 30"	540	510	233
H-1222	96 x 36"	605	570	268

**STEEL TOP WITH SQUARE EDGE.**  
1½" Thickness

MODEL NO.	DIMENSIONS L x W	PRICE EACH		WT. (LBS.)
		1	2+	
H-6863	48 x 24"	\$365	\$350	118
H-1128	48 x 30"	390	375	122
H-3657	48 x 36"	415	400	126
H-6864	60 x 24"	390	375	123
H-1135	60 x 30"	415	400	144
H-1136	60 x 36"	460	440	165
H-1137	72 x 30"	460	440	164
H-1138	72 x 36"	525	505	184
H-2484	96 x 30"	670	640	216
H-1222	96 x 36"	745	710	246

**LAMINATE TOP WITH ROUNDED EDGE.**  
1½" Thickness

MODEL NO.	DIMENSIONS L x W	PRICE EACH		WT. (LBS.)
		1	2+	
H-6863	48 x 24"	\$320	\$305	116
H-1128	48 x 30"	345	330	124
H-3657	48 x 36"	370	350	132
H-6864	60 x 24"	345	330	129
H-1135	60 x 30"	370	350	148
H-1136	60 x 36"	410	395	167
H-1137	72 x 30"	410	395	165
H-1138	72 x 36"	475	455	194
H-2484	96 x 30"	600	570	219
H-1222	96 x 36"	670	640	258

**MAPLE TOP WITH ROUNDED EDGE.**  
1½" Thickness

MODEL NO.	DIMENSIONS L x W	PRICE EACH		WT. (LBS.)
		1	2+	
H-6863	48 x 24"	\$415	\$395	113
H-1128	48 x 30"	425	410	130
H-3657	48 x 36"	490	465	147
H-6864	60 x 24"	480	455	124
H-1135	60 x 30"	490	465	152
H-1136	60 x 36"	540	520	180
H-1137	72 x 30"	540	520	178
H-1138	72 x 36"	615	595	208
H-2484	96 x 30"	750	725	232
H-1222	96 x 36"	850	825	270

**MAPLE TOP WITH SQUARE EDGE.**  
1½" Thickness

MODEL NO.	DIMENSIONS L x W	PRICE EACH		WT. (LBS.)
		1	2+	
H-6863	48 x 24"	\$415	\$395	113
H-1128	48 x 30"	425	410	130
H-3657	48 x 36"	490	465	147
H-6864	60 x 24"	480	455	124
H-1135	60 x 30"	490	465	152
H-1136	60 x 36"	540	520	180
H-1137	72 x 30"	540	520	178
H-1138	72 x 36"	615	595	208
H-2484	96 x 30"	750	725	232
H-1222	96 x 36"	850	825	270

**STAINLESS STEEL TOP WITH SQUARE EDGE.**  
1½" Thickness

MODEL NO.	DIMENSIONS L x W	PRICE EACH		WT. (LBS.)
		1	2+	
H-6863	48 x 24"	\$745	\$715	143
H-1128	48 x 30"	750	720	148
H-3657	48 x 36"	875	845	153
H-6864	60 x 24"	840	810	168
H-1135	60 x 30"	875	845	202
H-1136	60 x 36"	945	915	236
H-1137	72 x 30"	945	915	234
H-1138	72 x 36"	1,075	1,030	269
H-2484	96 x 30"	1,235	1,195	305
H-1222	96 x 36"	1,340	1,295	350







## HEAVY-DUTY PACKING TABLES

The heavyweight champ of packing tables. Recommended for machine shops, assembly plants and industrial manufacturing.

- Full perimeter, heavy-gauge steel frame holds up to a ton.
- Full-depth bottom shelf supports up to 500 lbs.
- Heavy-duty square tube legs. Adjustable height from 29 to 39" in 2" increments.



**Mobile** – 5" locking swivel casters. Height adjusts from 36 to 46". 1,000 lb. capacity.

STANDARD	MODEL NO.	DIMENSIONS L x W	COMPOSITE WOOD		LAMINATE		MAPLE	
			PRICE EACH		PRICE EACH		PRICE EACH	
			1	2+	1	2+	1	2+
	H-9002	60 x 30"	\$460	\$445	\$510	\$490	\$605	\$585
	H-9003	72 x 30"	510	490	550	530	670	650
	H-7607	72 x 36"	575	555	635	615	755	735
	H-9624	72 x 48"	770	745	820	795	1,040	1,015
	H-8400	96 x 36"	815	790	885	860	1,040	1,015
	H-9625	96 x 48"	1,025	1,000	1,090	1,065	1,390	1,360

With rounded edge

SHIPS UNASSEMBLED VIA MOTOR FREIGHT

MOBILE	MODEL NO.	DIMENSIONS L x W	COMPOSITE WOOD		LAMINATE		MAPLE	
			PRICE EACH		PRICE EACH		PRICE EACH	
			1	2+	1	2+	1	2+
	H-9005	60 x 30"	\$525	\$510	\$565	\$550	\$665	\$645
	H-9006	72 x 30"	565	550	610	590	725	705
	H-8020	72 x 36"	640	620	685	665	815	795
	H-9626	72 x 48"	835	810	880	855	1,105	1,075
	H-8401	96 x 36"	885	860	955	925	1,120	1,085
	H-9627	96 x 48"	1,105	1,075	1,170	1,140	1,475	1,440

With rounded edge

SHIPS UNASSEMBLED VIA MOTOR FREIGHT



## L-SHAPED WORKSTATIONS

Extra room lets you spread out and work on multiple projects.

- Select an L-shaped starter table and add accessories to uprights.
- Assembles in a left or right-hand configuration.
- Table height adjusts from 30 to 37".

**Starter Tables** – Includes L-shaped table, bottom shelf, drawer and uprights.

STARTER TABLES	MODEL NO.	DIMENSIONS L x W	ADJUSTABLE HEIGHT	CAP. (LBS.)	LAMINATE		STEEL		MAPLE	
					PRICE EACH		PRICE EACH		PRICE EACH	
					1	2+	1	2+	1	2+
	H-9628	72 x 78"	30-37"	1,000	\$1,045	\$1,020	\$1,095	\$1,070	\$1,235	\$1,210
	H-9629	96 x 78"			1,265	1,235	1,310	1,280	1,475	1,445

With square edge

SHIPS UNASSEMBLED VIA MOTOR FREIGHT



## CABINET WORKSTATIONS

Lock up your expensive power tools and hang up your 10,000th hammer.

- Select a starter table and add accessories to uprights.
- Spacious cabinet with adjustable shelf. 3-point lock.
- Table height adjusts from 28 to 38".
- Pre-drilled floor mounting pads.

**Starter Tables** – Includes table, locking cabinet and uprights.



Built like a tank

STARTER TABLES	MODEL NO.	DIMENSIONS L x W	ADJUSTABLE HEIGHT	CAP. (LBS.)	COMPOSITE WOOD		LAMINATE		MAPLE*	
					PRICE EACH		PRICE EACH		PRICE EACH	
					1	2+	1	2+	1	2+
	H-9635	60 x 30"	28-38"	2,000	\$775	\$755	\$840	\$820	\$960	\$940
	H-9636	72 x 30"			865	845	945	925	1,075	1,055
	H-9637	96 x 30"			1,150	1,130	1,250	1,230	1,425	1,405

\* With square edge

SHIPS UNASSEMBLED VIA MOTOR FREIGHT

# DELUXE WORKSTATIONS

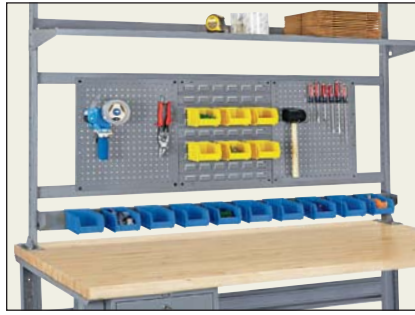

Customize your workstation for efficient assembly and repairs.

- Select a starter table and add on accessories.
- Easily add accessories to workstation uprights.
- Table height adjusts from 30-37". 500 lb. capacity.



**Starter Tables** – Includes table, full depth bottom shelf, drawer and uprights.

Electric Adjustable Height Workstations, see [uline.com](http://uline.com)

## STARTER TABLES

MODEL NO.	DIMENSIONS L x W	COMPOSITE WOOD		LAMINATE		MAPLE	
		PRICE EACH 1	PRICE EACH 2+	PRICE EACH 1	PRICE EACH 2+	PRICE EACH 1	PRICE EACH 2+
H-6843	48 x 30"	\$545	\$525	\$570	\$550	\$645	\$625
H-6844	48 x 36"	590	565	615	595	710	690
H-6341	60 x 30"	600	580	625	605	735	710
H-5769	60 x 36"	650	625	685	655	800	770
H-6342	72 x 30"	685	655	715	690	835	805
H-5770	72 x 36"	740	715	780	755	910	875
H-6343	96 x 30"	885	855	935	905	1,085	1,050
H-5771	96 x 36"	965	930	1,020	980	1,175	1,140

With rounded edge

SHIPS UNASSEMBLED VIA MOTOR FREIGHT

## ACCESSORIES



### SHELF – 12" DEEP

Store tools and supplies.

MODEL NO.	FITS TABLE LENGTH	PRICE EACH
H-6847	48"	\$48
H-5759	60"	58
H-5760	72"	67
H-5761	96"	89



### BIN RAIL

Hang Stackable Bins, page 491.

MODEL NO.	FITS TABLE LENGTH	PRICE EACH
H-6848	48"	\$33
H-5763	60"	40
H-5764	72"	44
H-5765	96"	52

## Hardware included for all accessories

### LED LIGHT KIT

Bright, long-lasting 48" light. 5,000 lumens.

MODEL NO.	FITS TABLE LENGTH	PRICE EACH
H-6849	48"	\$100
H-6330	60"	110
H-6331	72"	115
H-6332	96"	130



Includes 6' cord, brackets and suspension chains. Brackets screw into uprights.



### LOUVERED PANEL

Organize stackable bins.

MODEL NO.	DIMENSIONS W x H	PRICE EACH
H-5767	18 x 19"	\$27

48" table holds 2 panels, 60" and 72" hold 3 panels, 96" holds 4 panels.



### PEGBOARD PANEL

9/32" holes are 1" apart. Pegboard Accessories, page 633.

MODEL NO.	DIMENSIONS W x H	PRICE EACH
H-5768	18 x 19"	\$27

### POWER STRIPS

Power for all your tools right where you need it.

MODEL NO.	NO. OF OUTLETS	CORD LENGTH	PRICE EACH
H-6851	4	8'	\$47
H-4128*	12	6'	65

\*UL/C-UL Listed



H-4128

### H-4128 Tabletop

Power Strip – Mounts directly to tabletop.

H-6851 Leg Outlet – Mounts directly to leg cut-outs. 2 outlets on each side.



H-6851



### STORAGE CABINET

Secure storage. Includes cam lock and 2 keys.

MODEL NO.	DIMENSIONS L x W x H	WT. (LBS.)	PRICE EACH
H-6350	18 x 15 x 17"	20	\$145

### SHELF DIVIDERS

Set of 2

MODEL NO.	DIMENSIONS L x H	PRICE PER SET
H-6852	12 x 10"	\$36

Organize items on top shelf. Magnet for easy mounting.





## DELUXE PACKING TABLE

Keep all your packing needs within arm's length.

- 8' table with adjustable leveling feet. Includes 2 shelves, parts drawer, heavy-duty dowel and hold-down device for packing material. 1 1/4" thick laminate top.
- Tabletop cutter and paper cutters sold separately. See pages 782 and 785.

MODEL NO.	DESCRIPTION	DIMENSIONS L x W x H	CAP. (LBS.)	WT. (LBS.)	PRICE EACH	
					1	2+
H-214	Deluxe Table	96 x 36 x 76"	500	267	\$1,575	\$1,525
H-285	Cutter	75" Width	N/A	20	\$577 each	

With rounded edge

SHIPS UNASSEMBLED VIA MOTOR FREIGHT



ELECTRIC

## ADJUSTABLE HEIGHT WORKBENCHES

Avoid bending and stretching. Set to your preferred height.

- Recommended for repair and assembly areas with multiple shifts and users. 450 lb. capacity.
- Sturdy, telescoping legs adjust from 28 to 45" high. 3 programmable heights. Push-button control.
- Powered by 2 quiet electric motors. 10 1/2' power cord.



MODEL NO.	DIMENSIONS L x W	ADJUSTABLE HEIGHT	CAP. (LBS.)	LAMINATE		MAPLE	
				PRICE EACH		PRICE EACH	
				1	2+	1	2+
H-9618	48 x 30"	28-45"	450	\$1,285	\$1,235	\$1,390	\$1,340
H-8184	60 x 30"			1,325	1,275	1,430	1,380
H-8185	72 x 30"			1,390	1,340	1,495	1,445

With rounded edge

SHIPS UNASSEMBLED VIA MOTOR FREIGHT



5 legs with large feet for stability

## SIT/STAND WORK STOOL

Perch stool relieves foot and leg pain when standing for long periods of time.

- Easy-to-clean polyurethane seat resists stains and chemicals.
- Adjustable height. 360° swivel.
- Contoured seat with adjustable tilt mechanism.

MODEL NO.	SEAT DIMENSIONS W x D	CAP. (LBS.)	ADJUSTABLE HEIGHT	WT. (LBS.)	PRICE EACH	
					1	3+
H-5681	17 x 9"	350	22-32"	24	\$240	\$230

EASY ASSEMBLY. SHIPS VIA UPS.

## L-SHAPED INDUSTRIAL PACKING TABLES

Wraparound workbench provides extra space to get work done.

- Table holds up to 1,000 lbs.
- Assembles in a left or right-hand configuration.
- 14" deep bottom shelf for storage.
- Adjustable height from 30 to 37" in 1 1/2" increments.



MODEL NO.	DIMENSIONS L x W	ADJUSTABLE HEIGHT	CAP. (LBS.)	LAMINATE		STEEL		MAPLE	
				PRICE EACH		PRICE EACH		PRICE EACH	
				1	2+	1	2+	1	2+
H-8404	72 x 78"	30-37"	1,000	\$740	\$725	\$835	\$815	\$950	\$930
H-9620	96 x 78"			930	910	1,040	1,015	1,150	1,125

With square edge

SHIPS UNASSEMBLED VIA MOTOR FREIGHT



# PACKING STATIONS

Streamline your packing line with customizable workstations.

- Accessible storage for your boxes, envelopes and labels.



STARTER TABLE

- Select a starter table and add on accessories.
- Heavy-gauge steel frame. 1,200 lb. weight capacity.
- Adjustable height from 29 to 39" in 2" increments.
- Pre-drilled floor mounting pads.



Starter Tables – Includes table, full-depth bottom shelf with 4 dividers, open storage shelf and uprights.

## STARTER TABLES

MODEL NO.	DIMENSIONS L x W	COMPOSITE WOOD		LAMINATE		MAPLE	
		PRICE EACH		PRICE EACH		PRICE EACH	
		1	2+	1	2+	1	2+
H-7630	60 x 36"	\$695	\$670	\$730	\$700	\$845	\$815
H-7631	72 x 36"	790	760	835	805	975	945
H-8226	96 x 36"	1,075	1,040	1,140	1,105	1,340	1,305

With rounded edge

SHIPS UNASSEMBLED VIA MOTOR FREIGHT

## PACKING STATION ACCESSORIES

Hardware included for all accessories



**BOX SHELF W/ DIVIDERS** – 16" DEEP  
Store supplies. Includes 6 dividers.

MODEL NO.	FITS TABLE LENGTH	PRICE EACH
H-7632	60"	\$150
H-7634	72"	165
H-8227	96"	220



**SHELF** – 12" DEEP  
Store tools and supplies.

MODEL NO.	FITS TABLE LENGTH	PRICE EACH
H-5759	60"	\$58
H-5760	72"	67
H-5761	96"	89



**REEL HOLDER**  
Store and dispense kraft paper and labels. Includes 6 core adapters.

MODEL NO.	FITS TABLE LENGTH	PRICE EACH
H-7658	60"	\$35
H-7659	72"	40
H-8228	96"	55



**BIN RAIL**  
Hang Stackable Bins, page 491.

MODEL NO.	FITS TABLE LENGTH	PRICE EACH
H-5763	60"	\$40
H-5764	72"	44
H-5765	96"	52



**TAPE GUN HOLDER**  
Holds 2 tape guns for easy access. Mounts to upright or bin rail.

MODEL NO.	DIMENSIONS L x W x H	PRICE EACH
H-8232	9 x 6 x 4"	\$25



**WORKSTATION FAN**  
3 speeds. Head tilts and rotates 360°. 120 Volts.

MODEL NO.	FAN SIZE	PRICE EACH
H-8233	12"	\$140



**MONITOR ARM**  
For 17-30" monitors. Easy adjust, gas spring arm.

MODEL NO.	CAPACITY (LBS.)	PRICE EACH
H-7605	20	\$80



**LED LIGHT KIT**  
Bright, long-lasting 48" light. 5,000 lumens.

MODEL NO.	FITS TABLE LENGTH	PRICE EACH
H-6330	60"	\$110
H-6331	72"	115
H-6332	96"	130

ETL/C-ETL Listed. OSHA Compliant.



## WORKBENCH MATS

Sturdy, yet flexible. Protect your work surface from scratches, scuffs and dents.

- 5-layer PVC construction. 1/8" thick.
- Self-healing top surface. Nonslip bottom.

SPECIFY COLOR: Black, Blue or Gray

MODEL NO.	DESCRIPTION	DIMENSIONS L x W	WT. (LBS.)	PRICE EACH	
				1	2+
H-8179	Workbench Mats	48 x 22"	8	\$66	\$63
H-8180		60 x 28"	13	100	95
H-8181		72 x 28"	17	120	115

SHIPS VIA UPS

# MODULAR DRAWER WORKBENCHES



MAPLE TOP

Industrial workspace with secure storage for heavy parts and tools.

- Recommended for repair centers, garages and machine shops.
- Steel base installs on left or right side. 36" benchtop height.
- Full-extension locking drawers with heavy-duty roller bearings.
- Adjustable metal dividers included. Up to 16 compartments per drawer.

MODEL NO.	DIMENSIONS L x W	NO. OF DRAWERS	DRAWER HEIGHT	CAP. (LBS.)	LAMINATE TOP		MAPLE TOP		STAINLESS STEEL TOP	
					PRICE EACH		PRICE EACH		PRICE EACH	
					1	2+	1	2+	1	2+
H-10195	60 x 30"	5	(3) 4", (1) 6", (1) 8"	500	\$1,550	\$1,500	\$1,700	\$1,650	\$2,150	\$2,100
H-10196	72 x 30"				1,625	1,575	1,800	1,750	2,275	2,225
H-10197	96 x 30"				1,725	1,675	1,925	1,875	2,500	2,450

SHIPS UNASSEMBLED VIA MOTOR FREIGHT

## SHOP STANDS *New*



Impact-resistant workspace for drilling, sawing and packing.

- Powder-coated steel base with beefy 2½" square legs.
- 1¾" thick maple top. Full depth bottom shelf.

**Stationary** – Leveling feet prevent wobble. 30" high.

**Mobile** – Rolls smoothly on 4" locking swivel casters. 34" high.



MODEL NO.	DESCRIPTION	DIMENSIONS L x W	CAPACITY (LBS.)	WT. (LBS.)	PRICE EACH	
					1	2+
H-10199	Stationary	24 x 18"	1,500	61	\$300	\$285
H-10200		24 x 24"		73	350	335
■H-10201		36 x 24"		91	425	405

With square edge

■ SHIPS UNASSEMBLED VIA MOTOR FREIGHT

MODEL NO.	DESCRIPTION	DIMENSIONS L x W	CAPACITY (LBS.)	WT. (LBS.)	PRICE EACH	
					1	2+
H-10202	Mobile	24 x 18"	1,000	68	\$360	\$345
H-10203		24 x 24"		80	410	395
■H-10204		36 x 24"		98	485	465

With square edge

■ SHIPS UNASSEMBLED VIA MOTOR FREIGHT

## WORKBENCH PEDESTALS *New*



Keep tools, parts and paperwork organized and within reach.

- Durable powder-coated steel construction. All-welded.

**Cabinet** – Includes interior adjustable shelf. Lockable.

**4-Drawer** – Includes 1 tool tray and 4 dividers. Lockable.



### STATIONARY

MODEL NO.	DESCRIPTION	DIMENSIONS W x D x H	WT. (LBS.)	PRICE EACH	
				1	2+
H-7650	Cabinet	15 x 24 x 32"	45	\$210	\$195
H-7652	4-Drawer		88	310	290

SHIPS ASSEMBLED VIA MOTOR FREIGHT

### MOBILE – 3" casters: 2 locking swivel, 2 rigid

MODEL NO.	DESCRIPTION	DIMENSIONS W x D x H	WT. (LBS.)	PRICE EACH	
				1	2+
H-10212	Cabinet	15 x 24 x 36"	68	\$280	\$265
H-10213	4-Drawer		111	380	360

SHIPS ASSEMBLED VIA MOTOR FREIGHT



96 x 30" MAPLE TOP



60 x 30" STAINLESS TOP



72 x 30" LAMINATE TOP



# PEDESTAL WORKBENCHES

Create your own workstation.

- Sturdy, all-welded steel pedestals with 4 drawers or cabinet with adjustable shelf. Both locking. 34" high.
- Easy assembly with pre-drilled holes and included hardware.

Additional styles, see [uline.com](http://uline.com)

MODEL NO.	CONFIGURATION	DIMENSIONS L x W	CAP. (LBS.)	COMPOSITE WOOD TOP WITH ROUNDED EDGE. 1 1/2" Thickness		STEEL TOP WITH SQUARE EDGE. 1 1/2" Thickness		LAMINATE TOP WITH ROUNDED EDGE. 1 1/2" Thickness		MAPLE TOP WITH ROUNDED EDGE. 1 1/2" Thickness	
				PRICE EACH	PRICE EACH	PRICE EACH	PRICE EACH	PRICE EACH	PRICE EACH		
H-5927	4 Drawer/ 1 Leg	60 x 30"	500	\$655	\$630	\$715	\$690	\$695	\$665	\$820	\$795
H-5928		72 x 30"		695	665	750	725	735	710	855	830
H-2173	4 Drawer/ 1 Cabinet	60 x 30"	500	805	775	855	830	825	800	945	920
H-2174		72 x 30"		845	820	895	870	855	830	990	965
H-5929		96 x 30"		970	945	N/A	N/A	1,050	1,025	1,220	1,190
H-2171	4 Drawer/ 4 Drawer	60 x 30"	500	965	940	1,025	1,000	980	955	1,120	1,090
H-2172		72 x 30"		1,005	975	1,065	1,040	1,015	985	1,160	1,135
H-5930		96 x 30"		1,150	1,125	N/A	N/A	1,230	1,200	1,400	1,375

SHIPS UNASSEMBLED VIA MOTOR FREIGHT



MOBILE  
COMPOSITE

# CABINET WORKBENCHES

Customizable, secure storage for temporary or permanent work areas.

- Adjustable height in 2" increments. Heavy-gauge steel frame.
- Spacious cabinet with adjustable shelf and 3-point lock.

STANDARD

MODEL NO.	DIMENSIONS L x W	ADJUSTABLE HEIGHT	CAP. (LBS.)	COMPOSITE WOOD TOP WITH ROUNDED EDGE. 1 1/2" Thickness		LAMINATE TOP WITH ROUNDED EDGE. 1 1/2" Thickness		MAPLE TOP WITH SQUARE EDGE. 1 1/2" Thickness	
				PRICE EACH	PRICE EACH	PRICE EACH	PRICE EACH		
H-6993	48 x 30"	28-38"	2,000	\$595	\$575	\$645	\$625	\$725	\$705
H-6994	60 x 30"			655	635	715	695	830	810
H-6995	72 x 30"			740	720	810	790	940	920
H-8205	96 x 30"			1,010	985	1,120	1,095	1,280	1,255

SHIPS UNASSEMBLED VIA MOTOR FREIGHT

MOBILE

H-6996	48 x 30"	35-45"	1,200	\$660	\$640	\$710	\$690	\$795	\$775
H-6997	60 x 30"			725	705	780	760	900	880
H-6998	72 x 30"			805	785	875	855	1,010	985
H-8206	96 x 30"			1,080	1,055	1,190	1,165	1,355	1,330

SHIPS UNASSEMBLED VIA MOTOR FREIGHT

Standard – Pre-drilled floor mounting pads.

Mobile – 5" locking swivel casters.



STANDARD MAPLE



STEEL TOP  
4 DRAWER/1 LEG



LAMINATE TOP  
4 DRAWER/1 CABINET



96 x 30" MAPLE TOP  
4 DRAWER/4 DRAWER

HUGE 8 FT. WORKSPACE!



## SWIVEL SHOP STOOLS



Padded, adjustable seat for studios and repair shops.

- 1" foam seat and back with antimicrobial vinyl.
- Pneumatic height adjustment with 360° swivel.
- Welded steel frame with powder-coat finish.

MODEL NO.	DESCRIPTION	SEAT DIAM.	CAP. (LBS.)	ADJUSTABLE HEIGHT	WT. (LBS.)	PRICE EACH	
						1	3+
H-7660	Without Backrest	14"	300	24-32"	19	\$120	\$115
H-7661	With Backrest	14"	300	24-32"	22	135	130

EASY ASSEMBLY. SHIPS VIA UPS.

## BIG AND TALL WORK STOOL

Large and sturdy design. Generous 400 lb. capacity.

- Polyurethane resists stains, punctures and chemicals.
- Contoured seat and back provide comfort and support.
- Adjustable heavy-duty footing.
- Optional 3" casters provide mobility.



### POLYURETHANE

MODEL NO.	SEAT DIMENSIONS W x D	CAP. (LBS.)	ADJUSTABLE HEIGHT	WT. (LBS.)	PRICE EACH	
					1	3+
H-7668	19 x 17"	400	23-33"	40	\$335	\$325
H-7669	Set of Five Casters – Optional			7	38	36

EASY ASSEMBLY. SHIPS VIA UPS.



## VINYL PADDED MOBILE SHOP STOOL

Easy-to-move, versatile stool. Recommended for light-duty labs, clinics and offices.

- 3" foam padding. Antimicrobial vinyl seat is easy to clean.
- Adjustable height seat rotates 360°.
- Five legs with 2" swivel casters.

MODEL NO.	SEAT DIMENSIONS (DIAMETER)	CAP. (LBS.)	ADJUSTABLE HEIGHT	WT. (LBS.)	PRICE EACH	
					1	3+
H-7670	16"	275	17-22"	11	\$85	\$80
H-4832	Set of Five Glides – Optional			2	18	16

EASY ASSEMBLY. SHIPS VIA UPS.

## FOLDING WORKBENCHES

### WALL MOUNT

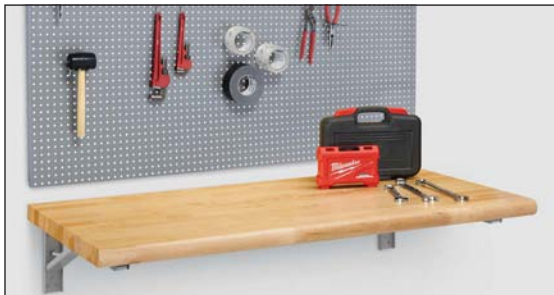

Large work surface folds down against wall to 4" depth.

Instant workbench. Fold up when you need it, fold down when you don't.

- Recommended for workshops, garages and stockrooms where space is a premium.
- Powder-coated steel frame supports up to 500 lbs.



With rounded edge

MODEL NO.	DIMENSIONS L x W	CAPACITY (LBS.)	WT. (LBS.)	LAMINATE		MAPLE	
				PRICE EACH		PRICE EACH	
				1	2+	1	2+
H-8992	48 x 24"	500	81	\$220	\$210	\$300	\$290
H-8993	60 x 24"		86	235	225	335	325

Mounting hardware included

SHIPS UNASSEMBLED VIA MOTOR FREIGHT

## MOBILE SERVICE WORKCENTER

Work on the move. Push this workbench wherever service duty calls.

- Heavy duty, all-welded steel construction. Convenient push handle.
- 36" high work surface. Lip on three sides so tools stay put.
- Lockable drawers and cabinet with adjustable shelf.
- Optional mat protects work surface from dents and scratches.
- 5" casters: 2 locking swivel, 2 rigid.



WORKBENCH MAT

MODEL NO.	DIMENSIONS L x W	CAPACITY (LBS.)	WT. (LBS.)	PRICE EACH	
				1	2+
H-8987	36 x 22"	1,400	172	\$1,125	\$1,100
H-8178*	Workbench Mat 36 x 22"		7	39	37

\* SPECIFY COLOR: Black, Blue or Gray

SHIPS ASSEMBLED VIA MOTOR FREIGHT

# WORK STOOLS

All-purpose stools with adjustable seat and footring for a custom fit.

**Fabric** – Provides additional cushioning for maximum comfort.

**Polyurethane** – Resists stains, punctures, water and chemicals.

**Deluxe Fabric or Polyurethane** – Includes seat and back tilt and adjustable, padded armrests.

- Optional casters provide mobility on carpet and hard surfaces.



## FABRIC

\* SPECIFY COLOR: Gray, Black or Blue

MODEL NO.	SEAT DIMENSIONS W x D	CAP. (LBS.)	ADJUSTABLE HEIGHT	WT. (LBS.)	PRICE EACH	
					1	3+
H-1376*	18 x 17"	300	22-32"	34	\$325	\$315
H-4823				39	430	420
H-1375WH	Set of Five Casters – Optional			2	18	16

EASY ASSEMBLY. SHIPS VIA UPS.

## POLYURETHANE

MODEL NO.	SEAT DIMENSIONS W x D	CAP. (LBS.)	ADJUSTABLE HEIGHT	WT. (LBS.)	PRICE EACH	
					1	3+
H-1375	18 x 17"	300	22-32"	34	\$295	\$285
H-3732				39	400	390
H-1375WH	Set of Five Casters – Optional			2	18	16

EASY ASSEMBLY. SHIPS VIA UPS.

# SHOP STOOLS

Used in maintenance shops, labs and trade schools.

- Welded steel construction.
- Powder-coat finish.
- Fixed or adjustable seat height.

**Hardboard** – Tough and long lasting. Optional metal backrest.

**Padded** – Foam-filled comfort. Optional padded backrest.



## HARDBOARD

MODEL NO.	DESCRIPTION	SEAT DIAMETER	CAP. (LBS.)	SEAT HEIGHT	PRICE EACH	
					1	3+
H-1917*	Without Backrest	14"	250	24"	\$47	\$43
H-2506				25-33"	59	56
H-4827	With Backrest	14"	250	24"	66	62
H-4828				25-33"	78	74

\* SHIPS ASSEMBLED

EASY ASSEMBLY. SHIPS VIA UPS.

## PADDED

SPECIFY COLOR: Gray or Black

MODEL NO.	DESCRIPTION	SEAT DIAMETER	CAP. (LBS.)	SEAT HEIGHT	PRICE EACH	
					1	3+
H-3729*	Without Backrest	14"	250	24"	\$53	\$50
H-3730				25-33"	64	61
H-4829	With Backrest	14"	250	24"	75	71
H-4830				25-33"	86	82

\* SHIPS ASSEMBLED

EASY ASSEMBLY. SHIPS VIA UPS.

# MOBILE SHOP STOOLS

Move easily through clinics, nail salons and repair shops.

**Standard** – Five legs with 2" swivel casters.

**Tool Tray** – Handy storage underneath. Five 3" swivel casters, two locking.

EASY ASSEMBLY. SHIPS VIA UPS.

MODEL NO.	DESCRIPTION	SEAT DIAMETER	CAP. (LBS.)	ADJUSTABLE HEIGHT	WT. (LBS.)	PRICE EACH	
						1	3+
H-1560	Standard	14"	300	16-21"	18	\$165	\$155
H-4831				18-25½"		180	170
H-3731	Tool Tray	14"	300	15-20"	18	255	240
H-4832	Set of Five Glides for Standard Stools – Optional			2	18	16	



Adjustable height polyurethane seat rotates 360°.

## LAB WORKBENCHES

Stands up to corrosive chemicals. Recommended for labs, chemical plants and science classrooms.

- Phenolic top resists heat up to 350°F. Non-porous, scratch and impact resistant.
- Heavy-gauge steel frame with sturdy square tube legs.
- Adjustable height from 29 to 39" in 2" increments.



Withstands harsh acids, moisture and bacteria.

MODEL NO.	DESCRIPTION	DIMENSIONS L x W	CAP. (LBS.)	PRICE EACH	
				1	2+
H-9638	Phenolic	60 x 30"	1,000	\$690	\$670
H-9639		72 x 30"		770	750

SHIPS UNASSEMBLED VIA MOTOR FREIGHT

## WORKBENCH LIGHTS



Adjustable lighting brightens up assembly and workstations.

- Includes long-lasting LED bulb.
- Clamps onto edge of tables and workbenches up to 2<sup>5</sup>/<sub>8</sub>" thick.

**Gooseneck** – Vinyl covered, industrial flexible arm.

**Articulating Arm** – Adjusts horizontally and vertically with 38" reach.

UL/C-UL Listed

MODEL NO.	DESCRIPTION	ARM REACH	WT. (LBS.)	PRICE EACH	
				1	3+
H-9641	Gooseneck	23"	5	\$170	\$165
H-9642	Articulating Arm	38"	8	275	265

EASY ASSEMBLY

SHIPS VIA UPS

## MACHINE TABLES

Adjustable height tables for light duty drilling and parts assembly.

- Legs are adjustable in 1" increments.
- Adjustable bottom shelf.
- 14-gauge steel top and 2" angle legs.



MODEL NO.	DIMENSIONS L x W	ADJUSTABLE HEIGHT	CAPACITY (LBS.)	WT. (LBS.)	PRICE EACH	
					1	2+
H-6979	24 x 18"	18-25"	1,500	42	\$105	\$100
H-6980		30-37"		52	115	110
■H-6981	36 x 24"	18-25"	1,500	61	145	135
■H-6982		30-37"		71	160	150

EASY ASSEMBLY

■ SHIPS VIA MOTOR FREIGHT



## BIG AND TALL WORK STOOLS

Extra-large seat accommodates the needs of big and tall users.

- 450 lb. capacity.
- 4" thick molded foam seat with fabric or antimicrobial vinyl.
- Adjustable seat height and padded armrests. Fixed footing.
- Heavy-duty steel base includes 2" swivel casters and 2" glides.

MODEL NO.	DESC.	SEAT DIM. W x D	CAP. (LBS.)	ADJUSTABLE HEIGHT	WT. (LBS.)	PRICE EACH	
						1	3+
H-5052	Fabric	23 x 20"	450	28½-32"	60	\$365	\$355
H-6990	Vinyl					430	415

EASY ASSEMBLY

SHIPS VIA UPS

## DELUXE WORK STOOLS

Large seat with 3" thick foam for all-day comfort.

- Antimicrobial vinyl keeps labs and hospitals germ free.
- Durable and easy to clean.
- Adjustable seat height, backrest and chrome footing.

H-6991 – With adjustable arms.



SPECIFY COLOR: Black or Blue

MODEL NO.	SEAT DIMENSIONS W x D	CAP. (LBS.)	ADJUSTABLE HEIGHT	WT. (LBS.)	PRICE EACH	
					1	3+
H-4066	20 x 18"	300	24-34"	36	\$380	\$370
H-6991				43	460	450
H-1375WH	Set of Five Casters – Optional			2	18	16

EASY ASSEMBLY

SHIPS VIA UPS



# WELDED STEEL WORKBENCHES

Lasts forever. Withstands the heaviest loads. Use in manufacturing, assembly areas and maintenance rooms.

- All-welded construction. No bolts to work loose.
- Beefy 2" square legs with pre-drilled floor mounting pads. 34" high.
- Wide, 18" deep bottom shelf.



1½" thick top with square edge

MODEL NO.	DIMENSIONS L x W	GAUGE	CAPACITY (LBS.)	WT. (LBS.)	PRICE EACH	
					1	2+
H-6223	48 x 30"	12	3,000	129	\$620	\$605
H-3077	60 x 30"			150	650	630
H-3078	72 x 30"			176	730	710
H-3079	72 x 36"			195	780	755
H-3626	96 x 36"			270	1,625	1,575

SHIPS ASSEMBLED VIA MOTOR FREIGHT

# WELDED STAINLESS STEEL WORKBENCHES

Recommended for laboratories and food service. Easy to wash down.

- Tough, corrosion-resistant work surface for sanitary applications.
- All-welded stainless steel construction.
- 2" angle legs with pre-drilled floor mounting pads. 35" high.
- Wide, 18" deep bottom shelf.



1½" thick top with square edge

MODEL NO.	DIMENSIONS L x W	GAUGE	CAPACITY (LBS.)	WT. (LBS.)	PRICE EACH	
					1	2+
H-3627	48 x 24"	14	1,500	75	\$970	\$945
H-3628	60 x 30"			95	1,140	1,105
H-3629	72 x 30"			112	1,230	1,195
H-8936	72 x 36"			134	1,530	1,490

SHIPS ASSEMBLED VIA MOTOR FREIGHT

# STEEL ASSEMBLY TABLES

Sturdy, versatile and adjustable. For temporary or permanent assembly areas.

- Heavy duty, 12-gauge welded steel tops.
- Adjustable height from 28-42" in 2" increments.
- Sturdy 2" square legs fold for convenient storage.
- Sets up easily. Hardware included.

With Bottom Shelf – Holds up to 450 lbs.



1½" thick top with square edge

MODEL NO.	DIMENSIONS L x W	ADJUST. HEIGHT	CAP. (LBS.)	WITHOUT BOTTOM SHELF			WITH BOTTOM SHELF		
				WT. (LBS.)	PRICE EACH		WT. (LBS.)	PRICE EACH	
					1	2+		1	2+
H-6833	60 x 30"	28-42"	2,000	100	\$330	\$315	137	\$430	\$415
H-5601	60 x 36"			120	340	325	167	450	435
H-6835	72 x 30"			127	365	350	171	480	465
H-3630	72 x 36"	28-42"	2,000	152	385	370	207	505	490
H-7698	72 x 48"			202	505	485	282	715	685
H-5602	96 x 36"			194	565	545	293	755	725

EASY ASSEMBLY. SHIPS VIA MOTOR FREIGHT.



# MOBILE WELDED STEEL TABLES



H-4996

Roll these heavy-duty workstations wherever needed in warehouses and machine shops.

- All-welded steel construction.
- Strong 1½" angle legs. 34" high.
- Full depth bottom shelf for added storage.
- 6" heavy-duty casters: 2 locking swivel, 2 rigid.



STEEL TOP WITH SQUARE EDGE. 1/2" Thickness

MODEL NO.	DIMENSIONS L x W	GAUGE	CAPACITY (LBS.)	WT. (LBS.)	PRICE EACH	
					1	2+
H-4995	48 x 24"			166	\$660	\$640
H-4996	60 x 30"	12	3,000	180	840	815
H-4997	72 x 36"			208	1,045	1,015

SHIPS ASSEMBLED VIA MOTOR FREIGHT

# WELDED STEEL MACHINE TABLES

Use as a dedicated workstation for drilling, sawing or packing.

- Built like a tank, compact and strong. Used every day at Uline warehouses.

\* Capacity with casters: 1,200 lbs.

MODEL NO.	DIMENSIONS L x W	GAUGE	CAPACITY (LBS.)	WT. (LBS.)	PRICE EACH	
					1	2+
H-4159	24 x 18"			70	\$260	\$250
H-4160	36 x 18"	12	3,000	88	315	305
H-4161	36 x 24"			103	365	355
H-6272	48 x 24"			123	455	440
H-4162*	5 x 2" Polyolefin Swivel Casters with Brake, Set of 4			70	67	

SHIPS ASSEMBLED VIA MOTOR FREIGHT

- 2" angle legs. Pre-drilled floor mounting pads.
- Optional casters add mobility.
- 30" high.



# WELDED STAINLESS STEEL MACHINE TABLES

Corrosion-resistant workstations for labs and auto shops. Easy to wash down.

- Heavy duty. Withstands abuse from greasy tools and harsh chemicals.

MODEL NO.	DIMENSIONS L x W	GAUGE	CAPACITY (LBS.)	WT. (LBS.)	PRICE EACH	
					1	2+
H-4913	24 x 18"			30	\$525	\$505
H-4914	24 x 24"	16	1,200	40	615	595
H-4915	36 x 24"			47	650	630

SHIPS ASSEMBLED VIA MOTOR FREIGHT

- 1½" angle legs. Pre-drilled floor mounting pads.
- Full depth bottom shelf.
- 30" high.



# MOBILE STEEL ASSEMBLY TABLES



Legs adjust in 2" increments and fold for convenient storage

Transfer heavy parts and machinery throughout your warehouse.

- 4" polyolefin locking swivel casters provide smooth mobility.
- 12-gauge welded steel tops.



LOCKABLE CASTERS

EASY ASSEMBLY. SHIPS VIA MOTOR FREIGHT.

MODEL NO.	DIMENSIONS L x W	ADJUST. HEIGHT	CAPACITY (LBS.)	WT. (LBS.)	PRICE EACH	
					1	2+
H-6834	60 x 30"			123	\$475	\$455
H-5785	60 x 36"			136	485	465
H-6836	72 x 30"	34-48"	1,000	149	515	495
H-5786	72 x 36"			168	525	505
H-5787	96 x 36"			210	780	750

# SHOP DESKS

Organize paperwork in busy shipping/receiving areas.

- Adjustable legs: 36 to 42½". Slanted or flat top writing surface.

**Compact** – 3 compartment organizer, locking hinged desktop.

**Standard** – 4 compartment organizer, locking drawer.

**Cabinet** – 42½" fixed height. Locking double doors, adjustable shelf.

MODEL NO.	DESCRIPTION	WRITING SURFACE	DIMENSIONS W x D	WT. (LBS.)	PRICE EACH	
					1	2+
H-4158*	Compact	Slanted	24¼ x 23"	60	\$220	\$210
H-1799	Standard	Slanted	34½ x 30"	88	265	255
H-5527		Flat			285	275
H-2058	Cabinet	Slanted	34½ x 30"	138	420	400
H-6860		Flat			440	420
H-6862*	Set of 4 Lockable Casters			4	32	31

\* SHIPS VIA UPS

SHIPS UNASSEMBLED VIA MOTOR FREIGHT



# MOBILE SHOP DESKS

Mobile, 3 compartment desk rolls from shipping to receiving.

- Slanted writing surface with front lip keeps pens from sliding off.
- 1 locking drawer plus a locking storage cabinet.
- 4" locking swivel casters.

SPECIFY COLOR: Gray or Blue

MODEL NO.	DESCRIPTION	DIMENSIONS W x D	WT. (LBS.)	PRICE EACH	
				1	2+
H-7699	Mobile Cabinet	24¼ x 23"	112	\$465	\$445

SHIPS UNASSEMBLED VIA MOTOR FREIGHT



# WALL MOUNT SHOP DESKS

Save space in areas with limited floor space.

**H-5499** – Desk space when you need it, folds up when you don't.

**H-2057** – 3 compartment organizer, locking hinged desktop.

MODEL NO.	DESCRIPTION	DIMENSIONS W x D	WT. (LBS.)	PRICE EACH	
				1	2+
H-5499	Folding Wall Mount	24½ x 17½"	22	\$135	\$125
H-2057	Wall Mount	24¼ x 23"	30	145	135

SHIPS VIA UPS



# DELUXE SHOP DESKS

Custom shop desk tailored to your shipping and receiving needs.

- Pegboard or louvered panels to hang tools, clipboards or bins.
- 4 compartment organizer, locking drawer and 12" deep shelf.
- 24" magnetic LED light available, see uline.com

Slanted writing surface

MODEL NO.	DESCRIPTION	DIMENSIONS W x D	WT. (LBS.)	PRICE EACH	
				1	2+
H-6865	Standard w/ Pegboard Panel	34½ x 30"	119	\$350	\$340
H-6866	Standard w/ Louvered Panel				
H-6867	Cabinet w/ Pegboard Panel	34½ x 30"	167	490	470
H-6868	Cabinet w/ Louvered Panel				

SHIPS UNASSEMBLED VIA MOTOR FREIGHT







## WORKTABLES WITH BACKSPASH

Generous 4" high backsplash. Protect your wall and floor from spills and splashes.

- Resists rust and corrosion. Easy to wash down.
- 1 5/8" diameter steel tube legs. 35" table height.

**Standard** – Galvanized legs and shelf. Type 430 top.

**Deluxe** – All stainless steel construction. Type 304 top.



FILLER TABLES, SEE PAGE 535

### STANDARD WITH BOTTOM SHELF

MODEL NO.	DIMENSIONS L x W	GAUGE	CAP. (LBS.)	WT. (LBS.)	PRICE EACH	
					1	2+
H-6259	48 x 30"	16	600	76	\$530	\$510
H-6260	60 x 30"			88	585	560
H-6261	72 x 30"			96	655	630
H-8915	96 x 30"			120	980	940

### DELUXE WITH BOTTOM SHELF

MODEL NO.	DIMENSIONS L x W	GAUGE	CAP. (LBS.)	WT. (LBS.)	PRICE EACH	
					1	2+
H-6916	48 x 30"	16	750	80	\$695	\$665
H-6917	60 x 30"			91	750	720
H-6918	72 x 30"			104	855	820
H-8917	96 x 30"			135	1,270	1,225

### STANDARD WITHOUT BOTTOM SHELF

H-8439	48 x 30"	16	600	65	\$475	\$455
H-8440	60 x 30"			77	525	505
H-8441	72 x 30"			85	600	575

### DELUXE WITHOUT BOTTOM SHELF

H-8442	48 x 30"	16	750	69	\$660	\$635
H-8443	60 x 30"			80	720	690
H-8444	72 x 30"			93	825	790

EASY ASSEMBLY. SHIPS VIA MOTOR FREIGHT.

EASY ASSEMBLY. SHIPS VIA MOTOR FREIGHT.

## WORKTABLES WITH SINK



Wash, rinse and prep. Ample workspace for restaurants and VFWs.

- All stainless steel construction. Type 304 top with 4" backsplash to protect wall from splashes.
- 16 x 18" sink with swivel faucet. 12" deep. Connects easily to standard plumbing.
- 35" table height. 1 5/8" diameter steel tube legs.
- Adjustable bottom shelf. Includes leveling feet.

SPECIFY SINK SIDE: Right or Left

MODEL NO.	DIMENSIONS L x W	WORKSPACE DIM. L x W	GAUGE	CAP. (LBS.)	WT. (LBS.)	PRICE EACH	
						1	2+
H-9652	48 x 30"	26 x 29"	16	750	85	\$1,040	\$990
H-8966	60 x 30"	38 x 29"			110	1,115	1,065
H-8967	72 x 30"	50 x 29"			127	1,205	1,155
H-10192	96 x 30"	74 x 29"			160	1,550	1,500

SHIPS UNASSEMBLED VIA MOTOR FREIGHT

## CABINET WORKBENCHES



Add workspace and storage in commercial kitchens, bakeries and labs.

- All stainless steel construction. Type 304 top.
- Spacious cabinet with locking sliding doors for easy access to supplies.
- 35" table height. 1 5/8" diameter legs with leveling feet.



MODEL NO.	DESCRIPTION	DIMENSIONS L x W	GAUGE	CAP. (LBS.)	WT. (LBS.)	PRICE EACH	
						1	2+
H-9653	Without Backsplash	60 x 30"	14	1,000	178	\$1,230	\$1,180
H-9654		72 x 30"			200	1,415	1,355
H-7562	With Backsplash	48 x 30"	14	1,000	160	1,115	1,075
H-7563		60 x 30"			182	1,250	1,200
H-7564		72 x 30"			208	1,435	1,375
H-8182		96 x 30"			264	1,700	1,635

SHIPS UNASSEMBLED VIA MOTOR FREIGHT

**With Backsplash** – Protects walls from spills and splashes. 4" high.

# STAINLESS STEEL WORKTABLES

NSF CERTIFIED

Used in every commercial kitchen and food processing plant.

- Resists rust and corrosion. Easy to wash down.
- 1 5/8" diameter steel tube legs. 35" table height.
- Available with or without bottom shelf.



**Standard** – Galvanized legs and shelf. Plastic leveling feet. Type 430 top.

**Deluxe** – All stainless steel construction. Type 304 top.



ADDITIONAL SIZES AVAILABLE,  
SEE ULINE.COM

## STANDARD WITH BOTTOM SHELF

MODEL NO.	DIMENSIONS L x W	GAUGE	CAP. (LBS.)	WT. (LBS.)	PRICE EACH	
					1	2+
H-8448	24 x 24"	16	600	26	\$245	\$235
H-8913	30 x 24"			35	290	275
H-7565	36 x 24"			43	330	315
H-6910	48 x 24"			51	375	355
H-6911	60 x 24"			61	415	395
H-6912	72 x 24"			67	455	435
H-8449	30 x 30"	16	600	40	335	320
H-8450	36 x 30"			48	350	335
H-4999	48 x 30"			64	440	425
H-5000	60 x 30"			76	495	475
H-5001	72 x 30"			84	565	545
H-5345	96 x 30"			108	915	875
H-7566	72 x 36"	16	600	101	655	630
H-8451	96 x 36"			130	985	945
H-9657	72 x 48"	16	600	135	920	885
H-9658	96 x 48"			173	1,265	1,220

## DELUXE WITH BOTTOM SHELF

MODEL NO.	DIMENSIONS L x W	GAUGE	CAP. (LBS.)	WT. (LBS.)	PRICE EACH	
					1	2+
H-8452	24 x 24"	16	750	27	\$375	\$355
H-8914	30 x 24"			36	430	410
H-7567	36 x 24"			44	485	465
H-6913	48 x 24"			54	540	520
H-6914	60 x 24"			63	600	580
H-6915	72 x 24"			74	655	630
H-8453	30 x 30"	16	750	42	495	475
H-8454	36 x 30"			51	520	500
H-5688	48 x 30"			68	660	635
H-5689	60 x 30"			79	720	695
H-5690	72 x 30"			92	825	790
H-5691	96 x 30"			126	1,210	1,160
H-7568	72 x 36"	16	750	110	950	910
H-8455	96 x 36"			151	1,300	1,250
H-9659	72 x 48"	16	750	147	1,220	1,170
H-9660	96 x 48"			201	1,570	1,515

## STANDARD WITHOUT BOTTOM SHELF

H-6256	48 x 30"	16	600	53	\$440	\$425
H-6257	60 x 30"			65	495	475
H-6258	72 x 30"			73	565	545
H-9655	96 x 30"			91	920	880

EASY ASSEMBLY. SHIPS VIA MOTOR FREIGHT.

## DELUXE WITHOUT BOTTOM SHELF

H-6919	48 x 30"	16	750	57	\$560	\$540
H-6920	60 x 30"			68	610	590
H-6921	72 x 30"			81	705	680
H-9656	96 x 30"			107	1,030	990

EASY ASSEMBLY. SHIPS VIA MOTOR FREIGHT.



## ECONOMY WORKTABLES



Budget friendly! Excellent choice for camps and church kitchens.

- Square edge sits flush against wall or another table.
- Corrosion-resistant type 430 stainless steel top.
- 35" table height. 1 5/8" diameter galvanized steel tube legs.
- Adjustable bottom shelf. Plastic leveling feet.

MODEL NO.	DIMENSIONS L x W	GAUGE	CAP. (LBS.)	WT. (LBS.)	PRICE EACH	
					1	2+
H-9643	36 x 24"	18	300	33	\$215	\$205
H-8963	48 x 24"			41	240	230
H-8964	60 x 30"			66	320	310
H-8965	72 x 30"			74	375	360
H-9644	96 x 30"			98	600	580

EASY ASSEMBLY. SHIPS VIA MOTOR FREIGHT.

## ADJUSTABLE HEIGHT WORKTABLES



Set to your preferred height. Keep your kitchen staff comfortable.

- Adjustable height from 28 to 42" in 2" increments.
- All stainless steel construction. Type 304 top.
- Adjustable bottom shelf. 1 5/8" diameter telescoping legs with leveling feet.



MODEL NO.	DIMENSIONS L x W	GAUGE	CAP. (LBS.)	WT. (LBS.)	PRICE EACH	
					1	2+
H-9648	48 x 24"	16	750	56	\$600	\$580
H-9649	60 x 30"			82	770	745
H-9650	72 x 30"			94	870	840
H-10348	96 x 30"			130	1,260	1,210

EASY ASSEMBLY. SHIPS VIA MOTOR FREIGHT.

## FOLDING TABLES New



Portable workstation. Used for catering, kitchens and tailgates.

- Quickly folds down for easy transport and storage.
- All stainless steel construction. Type 430 top.
- 31" table height. • 1" diameter tube legs with foot caps.

MODEL NO.	DIMENSIONS L x W	GAUGE	CAP. (LBS.)	WT. (LBS.)	PRICE EACH	
					1	4+
H-10349	60 x 30"	18	300	50	\$330	\$315
H-10350	72 x 30"			55	355	335

SHIPS ASSEMBLED VIA MOTOR FREIGHT



## ULINE WORK STOOLS

Durable seating for labs, repair shops and service counters.

- Puncture-resistant polyurethane.
- Adjustable seat, back tilt and footring.
- Height adjusts from 22-32" high.

MODEL NO.	DESCRIPTION	SEAT DIM. W x D	CAP. (LBS.)	WT. (LBS.)	PRICE EACH	
					1	3+
H-8512	Stool	18 x 18"	275	42	\$215	\$205
H-8513	Stool w/ Arms			50	260	250
H-1375WH	Set of Five Casters – Optional			2	18	16

EASY ASSEMBLY. SHIPS VIA UPS.



## MOBILE

Mix, chop and roll. Move your workspace where you need it.

- Easy portability for reconfiguring and cleaning work area.
- 1 5/8" diameter steel tube legs. 35" table height.
- Adjustable bottom shelf. 4" polyurethane locking swivel casters.

**Standard** – Galvanized legs and shelf. Type 430 top.

**Deluxe** – All stainless steel construction. Type 304 top.



### STANDARD

MODEL NO.	DIMENSIONS L x W	GAUGE	CAP. (LBS.)	WT. (LBS.)	PRICE EACH	
					1	2+
H-10290	36 x 24"	16	600	53	\$385	\$370
H-9645	48 x 24"			70	405	390
H-9646	60 x 30"			92	560	540
H-9647	72 x 30"			110	635	610

EASY ASSEMBLY. SHIPS VIA MOTOR FREIGHT.

### DELUXE

MODEL NO.	DIMENSIONS L x W	GAUGE	CAP. (LBS.)	WT. (LBS.)	PRICE EACH	
					1	2+
H-10291	36 x 24"	16	600	56	\$540	\$520
H-10292	48 x 24"			74	595	575
H-10293	60 x 30"			96	775	750
H-10294	72 x 30"			114	880	845

EASY ASSEMBLY. SHIPS VIA MOTOR FREIGHT.

## UTILITY STANDS

Easily add extra counter space for kitchen mixers and vacuum sealers.



- All stainless steel. Type 304 top.
- 24" table height. 1 5/8" diameter legs with leveling feet.
- Adjustable bottom shelf.

MODEL NO.	DIMENSIONS L x W	GAUGE	CAP. (LBS.)	WT. (LBS.)	PRICE EACH	
					1	2+
H-6922	24 x 24"	16	750	29	\$230	\$220
H-6923	30 x 30"			46	295	285
H-6924	36 x 30"			55	325	310

EASY ASSEMBLY. SHIPS VIA MOTOR FREIGHT.

## FILLER TABLES

A lifesaver. Fill the gap between your stove and prep station.

- All stainless steel. Type 304 top. 4" high backsplash.
- 35" table height. 1 5/8" diameter legs with leveling feet.
- Adjustable bottom shelf.



MODEL NO.	DIMENSIONS L x W	GAUGE	CAP. (LBS.)	WT. (LBS.)	PRICE EACH	
					1	2+
H-9745	12 x 30"	16	750	27	\$290	\$280
H-9746	18 x 24"			30	315	305
H-9747	18 x 30"			35	340	330

EASY ASSEMBLY. SHIPS VIA MOTOR FREIGHT.

## VORNADO® TOWER FAN



Portable and quiet. Use anywhere, from packing stations to the front office.

- Quiet V-Flow™ circulator moves air up to 80 feet. 4 fan speeds.
- Touch-button or remote control operation.
- Programmable timer up to 8 hours. 6' power cord. 120 Volts.

ETL/C-ETL Listed

MODEL NO.	DIMENSIONS W x H x D	FAN SPEEDS	AMPS	MAX. CFM	WT. (LBS.)	PRICE EACH	
						1	3+
H-7054	11 x 32 x 11"	4	0.6	400	11	\$130	\$120

SHIPS VIA UPS

## UTILITY SINK New

This sink gets the job done! Use in kitchens, bars and janitorial closets.

- Deep basin to wash large pots and rinse veggies. 11" backsplash.
  - All stainless steel. Type 304 bowl.
- Faucet** – 10" long, chrome finish. Swivels out of the way. Sold separately.



MODEL NO.	OVERALL DIM. L x W x H	BOWL DIM. L x W x D	CAP. (LBS.)	WT. (LBS.)	PRICE EACH	
					1	2+
H-10304	30 x 30 x 45"	24 x 24 x 14"	750	52	\$800	\$750
H-10305*	10" Swivel Faucet			3	\$165 each	

\*SHIPS VIA UPS

SHIPS UNASSEMBLED VIA MOTOR FREIGHT

# HEAVIEST DUTY MITY-LITE®



**GIANT  
1,500 LB. CAPACITY**

Load it up. Lasts forever.

- Rugged ABS plastic won't chip, crack or peel.
- Shockproof reinforced corners and edges protect against damage.
- 1" tube diameter. Durable 16-gauge steel legs.

## ABS PLASTIC FOLDING TABLES

2 YEAR WARRANTY



BEIGE TOP    BROWN TOP    GRAY TOP  
SPECIFY COLOR: BROWN FRAME    BROWN FRAME    BLACK FRAME

MODEL NO.	DIMENSIONS L x W x H	SHAPE	CAPACITY (LBS.)	WT. (LBS.)	PRICE EACH	
					1	4+
H-4516	72 x 30 x 29"	Rectangle	1,500	50	\$395	\$375
H-4517	96 x 30 x 29"				455	435

SHIPS ASSEMBLED VIA MOTOR FREIGHT

## FOLD-IN-HALF TABLES



**H-2754 Folding Bench –**  
Portable seating. 17" height.

Folds in the center for easy transportation and storage.

- Blow-molded polyethylene top.
- 29" fixed table height with locking steel legs.
- Folds in half to 4" thickness. Convenient carry handle.

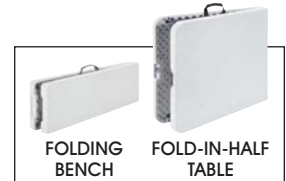

COLOR: White

MODEL NO.	DIMENSIONS L x W	SHAPE	CAPACITY (LBS.)	PRICE EACH	
				1	4+
H-4208FIH	48 x 24"	Rectangle	200	\$90	\$80
H-2749FIH	60 x 30"			110	100
H-2750FIH▲	72 x 30"			120	110
H-2751FIH	96 x 30"			160	150
H-3138FIH	48" Diam.	Round	200	130	120
H-2754	72 x 12"	Bench	800	85	75

▲ Also available in Black

SHIPS VIA UPS

## EVENT CHAIRS

Classic choice for outdoor weddings, receptions and hospitality tents.

- Lightweight for easy handling, storage and transit.
- Contoured polypropylene seat and back.
- Sturdy powder-coated steel frame.



SOLD IN CARTON QUANTITIES    SPECIFY COLOR: Burgundy, Black or White

MODEL NO.	DESCRIPTION	CAPACITY (LBS.)	SEAT HEIGHT	QTY./ CTN.	PRICE PER CHAIR	
					4	20+
H-8200	Plastic	275	18"	4	\$22	\$21

## VENTILATED FOLDING CHAIR

Breathable design. Keep cool at outdoor parties, concerts and sporting events.

- Comfortable seat and back gently flex for long-term comfort.
- Easy-to-clean polypropylene.
- Black powder-coated steel frame.



SOLD IN CARTON QUANTITIES

MODEL NO.	DESCRIPTION	CAPACITY (LBS.)	SEAT HEIGHT	QTY./ CTN.	PRICE PER CHAIR	
					4	20+
H-7691	Plastic	300	18"	4	\$39	\$36

# DELUXE FOLDING TABLES

MADE IN USA

Strong and sturdy – built to last. Wobble-free.

- 3 steel supports provide extra strength and durability.
- Blow-molded polyethylene top. Stain resistant.
- Tables come with adjustable or fixed legs.
- Folds to 2½" thickness for easy storage.
-  – 60 x 30" and 72 x 30" Adjustable Height available in Red and Blue.



## 5 YEAR WARRANTY

SPECIFY COLOR: Tan or Light Gray

MODEL NO.	DIMENSIONS L x W	SHAPE	CAPACITY (LBS.)	29" FIXED HEIGHT		22-32" ADJUSTABLE HEIGHT	
				PRICE EACH		PRICE EACH	
				1	4+	1	4+
H-3137*	48 x 24"	Rectangle	250	\$175	\$165	\$215	\$205
H-2228	60 x 30"			205	195	245	235
H-2229	72 x 30"			220	210	270	260
H-2230	96 x 30"			280	270	330	315
H-2520	60" Diam.	Round		380	365	N/A	N/A

\* SHIPS VIA UPS

SHIPS ASSEMBLED VIA MOTOR FREIGHT

# ECONOMY FOLDING TABLES

Set up in seconds for extra room at parties or picnics.

- Blow-molded polyethylene top.
- 29" fixed table height with locking steel legs.
- Folds to 2" thickness for easy storage.

▲ Only available in White

SPECIFY COLOR: White or Black

MODEL NO.	DIMENSIONS L x W	SHAPE	CAPACITY (LBS.)	PRICE EACH	
				1	4+
H-4208FOL*	48 x 24"	Rectangle	250	\$90	\$80
H-2749FOL	60 x 30"			105	95
H-2750FOL	72 x 30"			115	105
H-2751FOL	96 x 30"			155	145
H-4207*▲	36 x 36"	Square	250	105	95
H-3138FOL▲	48" Diam.	Round	250	115	105
H-4843▲	60" Diam.			195	185
H-4844▲	72" Diam.			275	265

\* SHIPS VIA UPS

SHIPS ASSEMBLED VIA MOTOR FREIGHT



# PERSONAL FOLDING TABLE

Great for Sundays. Review reports, sort files and prep for the week.

- Adjustable height up to 28" high.
- Folds to 2" thick for easy storage.
- Blow-molded polyethylene top with sturdy steel legs.



MODEL NO.	DIMENSIONS L x W	SHAPE	CAPACITY (LBS.)	PRICE EACH	
				1	4+
H-9134	30 x 20"	Rectangle	150	\$55	\$50

# BIG & TALL FOLDING CHAIRS

Rock solid frame and larger seat for super-sized comfort.

- Supports a hefty 400 lbs.
- Non-marring leg caps.

Vinyl Padded – 1½" foam-padded seat with 1" backrest. Easy to clean.



SOLD IN CARTON QUANTITIES

SPECIFY COLOR: Black or Blue

MODEL NO.	DESCRIPTION	CAPACITY (LBS.)	SEAT HEIGHT	QTY./CTN.	PRICE/CHAIR (MIN. 4)	
					4	20+
H-9135*	Steel	400	18"	4	\$37	\$35
H-9136	Vinyl Padded		19"		45	43

\* Only available in Black



# STEEL FOLDING CHAIRS



H-2234



H-2227



H-2522

Fold-away chairs for cafeterias and conference rooms.

**Economy** – Cross-braced chair for everyday use.

**Deluxe** – Double riveted, double-hinged U-braced legs for maximum support.

**Deluxe Vinyl Padded** – Comfortable 1 1/4" foam padded seat with 3/4" backrest. Easy to clean.



SOLD IN CARTON QUANTITIES

SPECIFY COLOR: Tan Black Brown

MODEL NO.	DESCRIPTION	CAPACITY (LBS.)	SEAT HEIGHT	QTY./CTN.	PRICE PER CHAIR (MIN. 4)	
					4	20+
H-2234*	Economy	275	17"	4	\$25	\$24
H-2227	Deluxe	300	17"		<b>\$27 each</b>	
H-2522	Vinyl Padded	300	18"		34	32

\*Only available in Tan or Black

# FABRIC PADDED STEEL FOLDING CHAIRS



Tan



Black



Burgundy

Attractive option for banquet halls and corporate seminars.

- Double riveted, double-hinged U-braced legs for maximum support.
- Comfortable 1 1/4" foam padded seat with 3/4" backrest.
- Non-marring leg caps protect floors from scratching.

SOLD IN CARTON QUANTITIES

SPECIFY COLOR: Tan, Black, Blue or Burgundy

MODEL NO.	DESCRIPTION	CAPACITY (LBS.)	SEAT HEIGHT	QTY./CTN.	PRICE PER CHAIR (MIN. 4)	
					4	20+
H-3139	Fabric Padded	300	18"	4	\$36	\$34

# PLASTIC FOLDING CHAIRS



H-3015



H-3016

Fold-away chairs for cafeterias, conference rooms and meeting halls.

**Economy** – Durable, UV-resistant HDPE for indoor and outdoor use.

**Deluxe** – Contoured back and seat for all-day comfort. Heavy-duty frame.

SOLD IN CARTON QUANTITIES

SPECIFY COLOR: Black or White

MODEL NO.	DESCRIPTION	CAPACITY (LBS.)	SEAT HEIGHT	QTY./CTN.	PRICE PER CHAIR (MIN. 4)	
					4	20+
H-3015	Economy	300	17"	4	\$39	\$37
H-3016	Deluxe	500	17"	4	50	48

# CHAIR DOLLIES



4" Casters

Speed setup and takedown of banquets, meetings and seminars.

- Easy to maneuver in tight spaces.
- Rugged powder-coated steel.



SHIPS UNASSEMBLED VIA MOTOR FREIGHT

MODEL NO.	DESCRIPTION	DIMENSIONS L x W x H	CHAIR CAPACITY		WT. (LBS.)	PRICE EACH	
			STEEL	PLASTIC		1	2+
H-2523	Platform	76 x 19 x 39"	35	26	55	\$315	\$305
H-2524		105 x 19 x 39"	50	34	66	410	400
H-2789	Two Tier	67 x 33 1/4 x 70"	84	48	105	545	525



# CHAIR AND TABLE COMBO DOLLY

Holy smokes! Store up to 12 tables and 42 chairs.

- Rugged powder-coated steel frame.
- Padded base protects table edges from damage.
- Tie-down straps included.
- 4" locking swivel casters.

SHIPS UNASSEMBLED VIA MOTOR FREIGHT

MODEL NO.	DESCRIPTION	DIMENSIONS L x W x H	CAPACITY		WT. (LBS.)	PRICE EACH	
			CHAIR	TABLE		1	2+
H-4787	Two Tier	65 x 33 x 70"	42	12	73	\$360	\$340

# LAMINATE FOLDING TABLES

Use in your warehouse, conference room or country club.

- 5/8" thick, solid core top with scratch-resistant surface.
- 29" fixed table height.
- Easily fold to 2½" thickness.
- Steel apron shields from damage when stored.
- Sturdy 18 gauge steel legs lock in place for extra stability.

MODEL NO.	DIMENSIONS L x W	SHAPE	CAPACITY (LBS.)	PRICE EACH	
				1	4+
H-4845*	48 x 24"	Rectangle	250	\$175	\$165
H-2231	60 x 30"			190	180
H-2232	72 x 30"			200	190
H-2233	96 x 30"			230	220
H-2521	60" Diam.	Round		340	325

\* SHIPS VIA UPS

SHIPS ASSEMBLED VIA MOTOR FREIGHT



## TABLE DOLLIES

Accommodate up to 12 folding tables.



- Carpeted deck protects tables from damage.
- Powder coated, 14 gauge welded steel frame.
- 4" polyurethane casters.



**H-3698** – Stack round and rectangular tables on edge for easy access.

MODEL NO.	MAX. TABLE LENGTH	DIMENSIONS L x W x H	TABLE CAPACITY	WT. (LBS.)	PRICE EACH	
					1	2+
H-3083	72"	74 x 32 x 43"	12	60	\$435	\$425
H-3084	96"	98 x 32 x 43"		69	475	465
H-3698	72" Round	49 x 32 x 41"	8	58	450	440

SHIPS ASSEMBLED VIA MOTOR FREIGHT

## SEMINAR TABLES

Ideal for training, seminars or conference rooms.

- Recessed leg design.
- 29" fixed table height.
- Folds to 2½" thickness.



**Plastic Top** – Cleans easily.

**Laminate Top** – Scratch resistant.

DIMENSIONS L x W	CAPACITY (LBS.)	PLASTIC		LAMINATE	
		MODEL NO.	PRICE EACH	MODEL NO.	PRICE EACH
60 x 18"	250	H-3080*	\$100 \$90	H-4129*	\$240 \$230
72 x 18"		H-3081*	110 100	H-4130*	250 240
96 x 18"		H-3082	145 135	H-4131	280 270

\* SHIPS VIA UPS

SHIPS ASSEMBLED VIA MOTOR FREIGHT

## FOLDING COCKTAIL TABLE

Stand and mingle. Easy setup for job fairs, theater lobbies and receptions.



- Blow-molded polyethylene top is easy to clean.
- 44" fixed table height. Locking steel legs.
- Folds to 2½" thickness for storage.



S-23156

MODEL NO.	DIMENSIONS	SHAPE	CAPACITY (LBS.)	PRICE EACH	
				1	4+
H-9717	32" Diam.	Round	250	\$85	\$80
S-23156	Stretch Table Cover		\$26 each	6+/\$24 each	

SHIPS VIA UPS

## STACKABLE BANQUET CHAIRS

Classic, comfortable seating for banquet halls, churches and convention centers.

- Welded steel frame with support bars.
- Durable fabric upholstery. 2½" thick padded seat.
- Rounded back with handle for stacking.



SOLD IN CARTON QUANTITIES

SPECIFY COLOR: Black or Burgundy

MODEL NO.	DESCRIPTION	CAPACITY (LBS.)	SEAT HEIGHT	QTY./CTN.	PRICE PER CHAIR (MIN. 4)	
					4	20+
H-9017	Fabric Padded	300	19"	4	\$59	\$56

SHIPS ASSEMBLED VIA MOTOR FREIGHT

## BIG AND TALL CHAIRS



Accommodates the biggest Green Bay Packers lineman.

- Giant 450 lb. capacity.
- Heavy-duty steel base with durable fabric upholstery.
- Padded, adjustable armrests. 5" thick molded foam seat.

SPECIFY COLOR:  Burgundy  Gray  Black

MODEL NO.	SEAT DIM. W x D	CAPACITY (LBS.)	ADJUSTABLE HEIGHT	WT. (LBS.)	PRICE EACH	
					1	2+
H-3643	23 x 20"	450	19-23"	58	\$330	\$310

EASY ASSEMBLY. SHIPS VIA UPS.

## BIG AND TALL LEATHER CHAIRS



Move up to the captain's chair. Super-sized comfort.

- Heavy-duty steel base with giant 450 lb. capacity.
- Thick, bonded leather over high-density molded foam.
- 5½" thick seat with 5½" pillowtop back.
- Adjustable armrests with extra-thick padding.

SPECIFY COLOR:  Dark Brown  Black

MODEL NO.	SEAT DIM. W x D	CAPACITY (LBS.)	ADJUSTABLE HEIGHT	WT. (LBS.)	PRICE EACH	
					1	2+
H-5522	22 x 20"	450	20-24"	63	\$350	\$335

EASY ASSEMBLY. SHIPS VIA UPS.

## MANAGER'S CHAIR



Good support for those late nights at the office.

- Durable fabric upholstery.
- Classic mid-back style.
- Polypropylene armrests.
- 4" thick foam seat with 3" back cushion.

MODEL NO.	SEAT DIM. W x D	CAPACITY (LBS.)	ADJUSTABLE HEIGHT	WT. (LBS.)	PRICE EACH	
					1	2+
H-4118	19 x 20"	275	17-21"	32	\$115	\$105

EASY ASSEMBLY. SHIPS VIA UPS.

## 24/7 MESH CHAIRS



Affordable luxury loaded with easy-to-use features.

- Seat and back adjust to desired height, angle and depth.
- Adjustable lumbar support.
- Padded, adjustable armrests. Heavy-duty steel base.
- 4" thick molded foam seat.

H-8277 – Extra-large seat and back.

MODEL NO.	SEAT DIM. W x D	CAPACITY (LBS.)	ADJUSTABLE HEIGHT	WT. (LBS.)	PRICE EACH	
					1	2+
H-10193	20 x 20"	275	19-23"	53	\$315	\$300
H-8277	23 x 21"	350		57	360	345

EASY ASSEMBLY. SHIPS VIA UPS.

## EXECUTIVE CHAIRS



H-8278

Long-lasting luxury for CEOs and Key decision-makers.

- Comfortable high-back style.
- Padded armrests.
- Thick, bonded leather over generous molded foam.

H-8278 – 4" thick seat with 3" back. Modern look with polished aluminum and chrome accents.

H-4116 – Overstuffed 5½" thick seat with 5" back. Extra-thick padded armrests.

SPECIFY COLOR:  Beige  Dark Brown  Black

MODEL NO.	SEAT DIM. W x D	CAPACITY (LBS.)	ADJUSTABLE HEIGHT	WT. (LBS.)	PRICE EACH	
					1	2+
H-8278*	21 x 20"	300	18-22"	40	\$245	\$235
H-4116	21 x 19"	275	19-23"	49	255	240

\*Black only

EASY ASSEMBLY. SHIPS VIA UPS.



H-4116



# OFFICE CHAIRS



H-3636 DELUXE TASK



H-4111 TASK



H-4112 TASK CHAIR W/ ADJUSTABLE ARMS



H-3641 MANAGER'S



H-2753 CONFERENCE ROOM

## FABRIC

**Task** – Ergonomic design with pneumatic adjustment. Back adjusts independently. 3" thick seat.

**Deluxe Task** – 6-way adjustability. Padded, adjustable armrests. 4" thick molded foam seat.

▲ SPECIFY COLOR: Black Burgundy Gray Black \* SPECIFY COLOR: Gray Black

MODEL NO.	SEAT DIM. W x D	CAPACITY (LBS.)	ADJUSTABLE HEIGHT	WT. (LBS.)	PRICE EACH	
					1	2+
H-4111*	19 x 17"	275	17-21"	30	\$135	\$125
H-4112*				35	160	150
H-3636▲	21 x 20"	275	18-22"	42	230	220

EASY ASSEMBLY. SHIPS VIA UPS.

## LEATHER

**Manager's** – Classic mid-back styling. Soft bonded leather upholstery. 3½" thick seat with 3" back.

**Conference Room** – Sit in comfort during long meetings. High-back style in bonded leather with plush foam. 5" thick seat and back.

MODEL NO.	SEAT DIM. W x D	CAPACITY (LBS.)	ADJUSTABLE HEIGHT	WT. (LBS.)	PRICE EACH	
					1	2+
H-3641	19 x 20"	275	17-21"	32	\$120	\$115
H-2753	21 x 22"		18-22"	41	\$155 ea. any qty.	

EASY ASSEMBLY. SHIPS VIA UPS.

# MESH CHAIRS



H-3642 TASK

**Task** – Hi-tech design. Ventilated mesh fabric keeps you cool and comfortable. Fixed armrests with 3½" thick seat.

**Deluxe Task** – Perfect blend of comfort and support. Padded, adjustable armrests. 5" thick seat with contoured screen back.

**All Mesh Task** – Superior airflow. Suspension mesh seat with contoured mesh back. Padded, adjustable armrests.

MODEL NO.	SEAT DIM. W x D	CAPACITY (LBS.)	ADJUSTABLE HEIGHT	WT. (LBS.)	PRICE EACH	
					1	2+
H-3642	20 x 19"	275	18-22"	33	\$165	\$155
H-4114	21 x 21"			48	235	225
H-6238	20 x 20"		17-21"	40	285	275

EASY ASSEMBLY. SHIPS VIA UPS.



H-6238 ALL MESH TASK



H-4114 DELUXE TASK



H-4119 FOAM PADDED

**Foam Padded** – Comfortable foam meets breathable mesh. Adjustable lumbar support and armrests. 3½" thick seat and 2½" back.

**Deluxe Mesh** – Fully loaded. Attractive chrome base with adjustable armrests and lumbar support. 4" thick molded foam seat.

▲ SPECIFY COLOR: Black Lime Green \* SPECIFY COLOR: Red Black

MODEL NO.	SEAT DIM. W x D	CAPACITY (LBS.)	ADJUSTABLE HEIGHT	WT. (LBS.)	PRICE EACH	
					1	2+
H-4119▲	21 x 19"	275	17-21"	40	\$210	\$200
H-4521*	22 x 21"		18-22"	50	265	255

EASY ASSEMBLY. SHIPS VIA UPS.



H-4521 DELUXE MESH

# CLASSIC COLLECTION

## OFFICE DESKS



H-5679

Desk 101. Plenty of room to get work done.

- 1" thick laminate top resists scratches, stains and spills. 30" height.
- Locking drawers with keys. Leveling feet prevent wobble.
- Impact-resistant PVC edges. Pedestals come fully assembled.

L-Desk – Offers extra workspace. Adjusts for left or right-hand configuration.

U-Desks available, see [uline.com](http://uline.com)



H-6301

COLOR: Mahogany

MODEL NO.	DESCRIPTION	DIMENSIONS L x W	WT. (LBS.)	PRICE EACH	
				1	2+
H-5679	Desk	66 x 30"	292	\$705	\$685
H-6853		72 x 36"	326	790	765

SHIPS UNASSEMBLED VIA MOTOR FREIGHT

COLOR: Mahogany

MODEL NO.	DESCRIPTION	DIMENSIONS L x W	WT. (LBS.)	PRICE EACH	
				1	2+
H-6301	L-Desk	66 x 78"	364	\$910	\$875
H-6854		72 x 84"	398	980	945

SHIPS UNASSEMBLED VIA MOTOR FREIGHT

## OFFICE STORAGE



H-6304

Matching storage for your important documents and reference materials.

- Durable laminate surface resists scratches, stains and spills.

Lateral File – Full-extension drawers. Lockable.

Credenza – Display awards and hide clutter. 4 file drawers and locking storage cabinet.

Mobile Pedestal File and Bookcases info and photos, see [uline.com](http://uline.com)



H-8224

### LATERAL FILE CABINET

COLOR: Mahogany

MODEL NO.	DESCRIPTION	DIMENSIONS W x D x H	WT. (LBS.)	PRICE EACH	
				1	2+
H-6304*	2-Drawer	36 x 22 x 30"	155	\$460	\$445

### MOBILE PEDESTAL FILE

H-8223	3-Drawer	16 x 22 x 29"	73	\$265	\$255
--------	----------	---------------	----	-------	-------

\*SHIPS ASSEMBLED

SHIPS UNASSEMBLED VIA MOTOR FREIGHT

### CREDENZA

COLOR: Mahogany

MODEL NO.	DESCRIPTION	DIMENSIONS W x D x H	WT. (LBS.)	PRICE EACH	
				1	2+
H-8224	Storage Credenza	68 x 22 x 30"	333	\$805	\$775

### BOOKCASES

H-6285	3-Shelf	32 x 14 x 47"	99	\$195	\$185
H-6286	5-Shelf	32 x 14 x 71"	137	265	255

SHIPS UNASSEMBLED VIA MOTOR FREIGHT



## BIG AND TALL MESH CHAIRS

Super-sized seating with generous proportions.

- Ventilated mesh fabric over 5½" thick molded foam seat.
- Heavy-duty steel base. 450 lb. capacity.
- Padded, adjustable armrests.

SPECIFY COLOR:  Black  Blue

MODEL NO.	SEAT DIM. W x D	CAPACITY (LBS.)	ADJUSTABLE HEIGHT	WT. (LBS.)	PRICE EACH	
					1	2+
H-6861	22 x 20"	450	20-24"	60	\$335	\$320

EASY ASSEMBLY. SHIPS VIA UPS.

## FASHION CHAIRS

Take your seat in style. Clean, sleek design for modern offices.

- Ribbed bonded leather upholstery. Foam padding.
- 2½" thick seat and back.
- Chrome-plated steel arms and base.



SPECIFY COLOR:  Black  White  Red  Brown

MODEL NO.	SEAT DIM. W x D	CAPACITY (LBS.)	ADJUSTABLE HEIGHT	WT. (LBS.)	PRICE EACH	
					1	2+
H-4120	21 x 18"	275	18-22"	42	\$235	\$225

EASY ASSEMBLY. SHIPS VIA UPS.

# CLASSIC COLLECTION

## STACKABLE CHAIRS

Sturdy, durable chairs stack neatly when not in use.

- Steel frame. Powder-coat finish.

### FABRIC

- Classic look and comfort for breakrooms and reception areas.
- 2½" thick foam padded seat with 2" back.



SPECIFY COLOR: Burgundy, Black, Blue or Green

MODEL NO.	DESCRIPTION	SEAT DIM. W x D	CAPACITY (LBS.)	SEAT HEIGHT	PRICE EACH	
					1	6+
H-3733	Fabric	19 x 17½"	300	19"	\$70	\$65
H-3734	Fabric w/ Armrests				75	70

EASY ASSEMBLY. SHIPS VIA UPS.



### VINYL

- Antimicrobial and easy to clean in waiting rooms and clinics.
- 2½" thick foam padded seat with 2" back.

SPECIFY COLOR: Black or Burgundy

MODEL NO.	DESCRIPTION	SEAT DIM. W x D	CAPACITY (LBS.)	SEAT HEIGHT	PRICE EACH	
					1	6+
H-6522	Vinyl	19 x 17½"	300	19"	\$85	\$80
H-6523	Vinyl w/ Armrests				95	90

EASY ASSEMBLY. SHIPS VIA UPS.

### MESH

- Breathable mesh comfort for lobbies and offices.
- 3½" extra thick padded mesh upholstered seat and contoured mesh back.



MODEL NO.	DESCRIPTION	SEAT DIM. W x D	CAPACITY (LBS.)	SEAT HEIGHT	PRICE EACH	
					1	6+
H-7684	Mesh	20 x 19"	300	19"	\$140	\$130
H-6965	Mesh w/ Armrests				150	140

EASY ASSEMBLY. SHIPS VIA UPS.

## CAFÉ TABLES



Bring people together for a meeting, lunch break or study session.

- 1¼" thick top with smooth, scratch-resistant laminate surface.
- Sturdy, 4-prong steel base. Leveling feet prevent wobble.
- Easy to clean. 30" high.



SPECIFY TOP COLOR: ■ Mahogany ■ Light Gray ■ Black

MODEL NO.	SHAPE	DIMENSIONS L x W	WT. (LBS.)	PRICE EACH	
				1	4+
H-8183	Round	30" Diam.	49	\$200	\$190
H-6267		36" Diam.	58	225	215
H-6268		42" Diam.	73	260	250
H-6269	Square	36 x 36"	66	225	215
H-6270		42 x 42"	85	260	250

EASY ASSEMBLY. SHIPS VIA MOTOR FREIGHT.

## CONFERENCE TABLES

Old standby that seems to last forever. Used everywhere.

- Easy care laminate surface resists scratches and stains.
- Durable 1½" thick top resists warping. 30" table height.

COLOR: Mahogany

MODEL NO.	SHAPE	DIMENSIONS L x W	SEATING CAPACITY	WT. (LBS.)	PRICE EACH	
					1	2+
H-5054	Racetrack	71 x 35"	6	116	\$330	\$320
H-5055		96 x 43"	8	180	445	430
H-7058		120 x 47"	10	237	565	540

EASY ASSEMBLY. SHIPS VIA MOTOR FREIGHT.



Round Table, see uline.com



# DOWNTOWN COLLECTION

## CONFERENCE TABLES



Modern, spacious design with room for the whole team.

- Sturdy steel frame with square tube legs, modesty panels and leveling feet.
- Heavy-duty, 1 3/4" thick laminate top with PVC edges. 30" table height.

### STANDARD

COLOR: Gray

MODEL NO.	SHAPE	DIMENSIONS L x W	SEATING CAPACITY	WT. (LBS.)	PRICE EACH	
					1	2+
H-8234	Rectangle	96 x 48"	8	190	\$780	\$745
H-8235		144 x 48"	12	304	1,100	1,050
H-8236		192 x 48"	16	419	1,415	1,360

SHIPS UNASSEMBLED VIA MOTOR FREIGHT

### POWERED – Pop-up power center: 2 outlets/2 USB ports

COLOR: Gray

MODEL NO.	SHAPE	DIMENSIONS L x W	SEATING CAPACITY	WT. (LBS.)	PRICE EACH	
					1	2+
H-8954	Rectangle	96 x 48"	8	197	\$870	\$830
H-8237		144 x 48"	12	311	1,185	1,130
H-8238		192 x 48"	16	432	1,560	1,495

SHIPS UNASSEMBLED VIA MOTOR FREIGHT

## DOWNTOWN MESH CHAIRS



Cool, clean and comfortable for trendy downtown offices.

- 3 1/2" molded foam seat with fabric upholstery.
- Contoured high-back style with airy screen mesh.
- Adjustable lumbar support.
- Padded, adjustable armrests.

SPECIFY COLOR: White or Black

MODEL NO.	SEAT DIM. W x D	CAPACITY (LBS.)	ADJUSTABLE HEIGHT	WT. (LBS.)	PRICE EACH	
					1	2+
H-7628	20 x 20"	275	17-21"	41	\$230	\$220

EASY ASSEMBLY. SHIPS VIA UPS.

## ERGO MESH CHAIRS

Find your comfort zone! 9 adjustments provide a custom fit.

- 4" molded foam seat with fabric upholstery.
- Breathable mesh back adjusts to desired height and angle.
- Adjustable seat depth and tilt functions.
- 3-way adjustable padded armrests.



SPECIFY COLOR: Black or Gray

MODEL NO.	SEAT DIM. W x D	CAPACITY (LBS.)	ADJUSTABLE HEIGHT	WT. (LBS.)	PRICE EACH	
					1	2+
H-7690	20 x 20"	275	19-23"	52	\$275	\$265

EASY ASSEMBLY. SHIPS VIA UPS.

## OFFICE WORKSTATIONS



H-8248

- L-DESK SET INCLUDES:**
- 2 (72 x 60") L-Desks
  - 2 Mobile Pedestal Files
  - 1 (12") Privacy Panel

Everything you need to set up and get working quickly.



H-8247

- BACK-TO-BACK SET INCLUDES:**
- 2 (60 x 24") Desks
  - 2 Mobile Pedestal Files
  - 1 (12") Privacy Panel

SPECIFY COLOR:  Gray  Espresso

MODEL NO.	DESCRIPTION	DIMENSIONS L x W	WT. (LBS.)	PRICE EACH
H-8247RT	2-Person Back-to-Back	60 x 48"	277	\$1,300
H-8248RT	2-Person L-Desk	120 x 72"	375	1,635

SHIPS UNASSEMBLED VIA MOTOR FREIGHT

- Sturdy steel frame with stylish, 1" thick laminate top.
- Mobile pedestal files for convenient, lockable storage.
- Frosted acrylic panel adds privacy.
- Cable grommets.

# DOWNTOWN COLLECTION



H-7742  
With optional 2-Drawer  
Mobile Pedestal File

## OFFICE DESKS

Industrial chic for contemporary, urban offices.

- Stylish laminate top. 1" thick with PVC edges and cable grommets. 30" height.
- Sturdy steel frame with square tube legs and full-length modesty panel.



H-7751

L-Desk – Adds extra workspace.  
For left or right-hand configuration.

SPECIFY COLOR:  Gray  Espresso

MODEL NO.	DESCRIPTION	DIMENSIONS L x W	WT. (LBS.)	PRICE EACH	
				1	2+
H-8948	Desk	48 x 24"	61	\$385	\$365
H-7741		60 x 24"	70	445	420
H-7742		72 x 24"	82	475	450
H-8217		60 x 30"	81	480	455
H-8218		72 x 30"	94	520	495

SHIPS UNASSEMBLED VIA MOTOR FREIGHT

SPECIFY COLOR:  Gray  Espresso

MODEL NO.	DESCRIPTION	DIMENSIONS L x W	WT. (LBS.)	PRICE EACH	
				1	2+
H-7750	L-Desk	60 x 60"	106	\$625	\$595
H-7751		72 x 72"	127	715	680
H-8219		72 x 78"	139	760	725

SHIPS UNASSEMBLED VIA MOTOR FREIGHT

## MOBILE PEDESTAL FILES

SPECIFY COLOR:  Gray  Espresso

MODEL NO.	DESCRIPTION	DIMENSIONS W x D x H	WT. (LBS.)	PRICE EACH	
				1	2+
H-7759	2-Drawer	16 x 20 x 26"	73	\$230	\$220
H-8953	3-Drawer		69	250	240

SHIPS UNASSEMBLED VIA MOTOR FREIGHT

Companion storage fits under  
Downtown Office Desks.

- 5 swivel casters, 2 locking.
- 2-Drawer** – 1 file drawer, 1 box drawer.
- 3-Drawer** – 1 file drawer, 2 box drawers.



## OFFICE TABLES

Adds a "downtown" look to any office. For quick meetings and collaborative work.

- Stylish, 1" thick laminate top with protected PVC edges. 30" height.

SPECIFY COLOR:  Gray  Espresso

MODEL NO.	DESCRIPTION	DIMENSIONS L x W	WT. (LBS.)	PRICE EACH	
				1	2+
H-7761	Table	60 x 30"	73	\$360	\$345
H-7762		72 x 30"	84	445	420

SHIPS UNASSEMBLED VIA MOTOR FREIGHT

- 2 cable grommets.
- Sturdy steel frame with square tube legs and 4 leveling feet.



## ZIPPERED OFFICE PANELS



Sound-absorbing panels quickly create walls and private spaces.

- Recommended for offices, schools and clinics.
- **Full-length zippers** for easy setup and teardown.
- Lightweight, easy to move. 1 5/8" thick.
- Steel boomerang feet sit flush to the floor.



SPECIFY COLOR: Gray or Black

MODEL NO.	DESCRIPTION	DIMENSIONS W x H	WT. (LBS.)	PRICE EACH	
				1	4+
H-7590	Panel	30 x 60"	30	\$245	\$230
H-8956		30 x 72"	38	265	250

SHIPS UNASSEMBLED VIA MOTOR FREIGHT

# DOWNTOWN COLLECTION

## ROOM DIVIDERS

Instantly create a private area with a modern and stylish look. Recommended for offices and cafés.

- Laminate wall with frosted acrylic windows blocks distractions, while allowing light through.
- Easily build longer walls and corners. End posts have 4-way connection to attach Add-On Dividers.



Sturdy aluminum frame with wide steel feet ensures stability.

### STARTER DIVIDERS

MODEL NO.	DIMENSIONS W x H	WT. (LBS.)	PRICE EACH	
			1	2+
H-9158	68 x 78"	59	\$590	\$570
H-9160	80 x 78"	64	640	620

### ADD-ON DIVIDERS

MODEL NO.	DIMENSIONS W x H	WT. (LBS.)	PRICE EACH	
			1	2+
H-9158A	68 x 78"	50	\$510	\$490
H-9160A	80 x 78"	54	550	530

52" Height Dividers available, see uline.com

SHIPS UNASSEMBLED VIA MOTOR FREIGHT

## DELUXE CAFÉ TABLES

Modern design used in breakrooms, cafés and lounges.

- 1" thick laminate top with beveled edge.
- Scratch-resistant and easy to clean. 30" high.
- Sturdy, round steel base with 3" diam. steel column.



SPECIFY COLOR:  Gray  White Wood

MODEL NO.	SHAPE	DIMENSIONS L x W	WT. (LBS.)	PRICE EACH	
				1	4+
H-9175	Round	36" Diameter	85	\$265	\$255
H-9176		42" Diameter	92	295	285
H-9718	Square	36 x 36"	89	265	255
H-9719		42 x 42"	100	295	285

EASY ASSEMBLY. SHIPS VIA MOTOR FREIGHT.

## MOBILE TRAINING TABLES New

Sleek design that's built to last. Host conferences and training sessions.

- Durable, 1" thick laminate top with 2 cable grommets. 29½" height.
- Two flip levers. Quickly flip top from either end of table.

COLOR: Gray

MODEL NO.	SHAPE	DIMENSIONS L x W	CAPACITY (LBS.)	WT. (LBS.)	PRICE EACH	
					1	4+
H-10216	Rectangle	60 x 24"	300	61	\$425	\$410
H-10217		72 x 30"		81	525	510

SHIPS UNASSEMBLED VIA MOTOR FREIGHT

- Powder-coated steel frame.
- 3" locking swivel casters.



Top flips up to nest for compact storage.

## AIR MESH CHAIRS

Look cool, feel cool. A sleek seat for any conference room or workspace.

- Lightweight. Provides comfort and support.
- All-mesh seat and fixed armrests.
- Adjustable tilt with hidden, recessed lever.



SPECIFY COLOR:  Green  Gray  Black

MODEL NO.	SEAT DIM. W x D	CAPACITY (LBS.)	ADJUSTABLE HEIGHT	WT. (LBS.)	PRICE EACH	
					1	2+
H-9154	19 x 18"	275	17-21"	20	\$225	\$215

EASY ASSEMBLY. SHIPS VIA UPS.

## DELUXE ALL-MESH CHAIRS

Modern style meets cool comfort. Adjusts to fit your body and work style.

- Breathable all-mesh seat and back with headrest.
- Contoured back with built-in lumbar support.
- Adjustable seat depth and armrests.



WITH HEADREST

SPECIFY COLOR:  Blue  Gray

MODEL NO.	SEAT DIM. W x D	CAPACITY (LBS.)	ADJUSTABLE HEIGHT	WT. (LBS.)	PRICE EACH	
					1	2+
H-9765	20 x 20"	275	18-22"	44	\$320	\$305

EASY ASSEMBLY. SHIPS VIA UPS.



# DOWNTOWN COLLECTION

## ADJUSTABLE HEIGHT DESKS

Take a stand. Create a healthy, ergonomic workspace with downtown style.

- Simple-to-use push-button control with 4 programmable heights.
- Stylish, 1" thick laminate top with 2 cable grommets. • 10' power cord.
- Modesty panel for privacy and a professional, finished look.



Adjust from 28½ to 48" high. Powered by 2 quiet electric motors.

SPECIFY COLOR:  Gray  Espresso

MODEL NO.	DESCRIPTION	DIMENSIONS L x W	WT. (LBS.)	PRICE EACH	
				1	2+
H-9179	Adjustable Height Desk	60 x 30"	127	\$805	\$785
H-9180		72 x 30"	141	835	815

SHIPS UNASSEMBLED VIA MOTOR FREIGHT

## OFFICE STORAGE



H-6304

Complete your office look with matching storage.

- Durable, laminate surface resists scratches, stains and spills.

**Lateral File** – 2 full-extension drawers for letter or legal-size documents. Lockable.

**Credenza** – Display awards and hide clutter.

Bookcases and Storage Cabinets, see [uline.com](http://uline.com)



H-8224

COLOR: Gray

MODEL NO.	DESCRIPTION	DIMENSIONS W x D x H	WT. (LBS.)	PRICE EACH	
				1	2+
H-6304	Lateral File Cabinet	36 x 22 x 30"	155	\$460	\$445

SHIPS ASSEMBLED VIA MOTOR FREIGHT

COLOR: Gray

MODEL NO.	DESCRIPTION	DIMENSIONS W x D x H	WT. (LBS.)	PRICE EACH	
				1	2+
H-8224	Storage Credenza	68 x 22 x 30"	333	\$805	\$775

SHIPS UNASSEMBLED VIA MOTOR FREIGHT

## PRIVACY WORKSTATIONS



H-9207

- 1-PERSON KIT INCLUDES:**
- 1 (72 x 72") L-Desk
  - 1 Mobile Pedestal File
  - 4 Panels (36 x 42" OR 36 x 62")



H-9208

- 2-PERSON KIT INCLUDES:**
- 2 (72 x 72") L-Desks
  - 2 Mobile Pedestal Files
  - 6 Panels (36 x 42" OR 36 x 62")

Create defined, private workspaces in under an hour.

- Polyester fabric panels block distractions and reduce noise. 1 5/8" thick, tackable.
- Panels have foam-padded MDF core and aluminum frame. Easily connect to desk with included brackets.
- Sturdy steel desk frame with stylish, 1" thick laminate top. • Lockable, mobile pedestal files.

- Desktop cable grommets.

**Overhead Cabinet** – Store supplies without taking up desk space. Lockable.

SPECIFY COLOR:  Gray  Espresso

MODEL NO.	DESCRIPTION	DIMENSIONS L x W	42" HEIGHT			62" HEIGHT		
			PRICE EACH	WT. (LBS.)		PRICE EACH	WT. (LBS.)	
H-9207	1-Person Kit	74 x 74"	\$1,270	\$1,220	349	\$1,560	\$1,500	434
H-9208	2-Person Kit	146 x 74"	2,195	2,120	612	2,485	2,400	739
H-9213RT*	Optional Overhead Cabinet – 29 x 11 x 11" (W x D x H)					130	125	25

\* Only compatible with 62" Height Workstations

SHIPS UNASSEMBLED VIA MOTOR FREIGHT

# DESKTOP MONITOR MOUNTS



Articulating arm positions your monitor right where you need it.

- Multiple adjustments – Tilt, swivel, rotate, raise and lower.
- For 17-30" monitors. Clamps to desk or mounts to cable grommet.

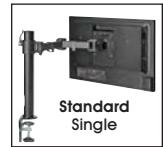

**Standard** – Steel housing. Simple articulating design.

**Easy-Adjust** – Aluminum housing. Gas spring arm provides full range of motion. Built-in USB, audio and microphone ports.

MODEL NO.	DESCRIPTION	NO. OF MONITORS	LOAD CAP. (LBS.)	WT. (LBS.)	PRICE EACH	
					1	3+
H-7618	Standard	Single	20	6	\$43	\$41
H-7619		Dual	40	9	56	53

EASY ASSEMBLY. SHIPS VIA UPS.

MODEL NO.	DESCRIPTION	NO. OF MONITORS	LOAD CAP. (LBS.)	WT. (LBS.)	PRICE EACH	
					1	3+
H-7620	Easy-Adjust	Single	20	7	\$115	\$110
H-7621		Dual	40	11	205	195

EASY ASSEMBLY. SHIPS VIA UPS.

# RECEPTION DESKS

## DOWNTOWN COLLECTION



Meet and greet visitors in offices, health clubs and clinics.

- 42" high counter for sign-ins and transactions.
- 1" thick laminate top with sleek privacy hutch.
- Sturdy steel frame with square tube legs is fully enclosed.



**L-Desk** – Left or right-hand configuration.

COLOR: Gray

MODEL NO.	DESCRIPTION	DIMENSIONS L x W	WT. (LBS.)	PRICE EACH	
				1	2+
H-9752	Desk	72 x 30"	188	\$825	\$795
H-9753	L-Desk	72 x 78"	271	1,150	1,100

SHIPS UNASSEMBLED VIA MOTOR FREIGHT

# RECEPTION FURNITURE

## DOWNTOWN COLLECTION

Keep your waiting guests comfortable and happy.

**Guest Chairs** – Comfortable, 3½" thick molded foam seat and padded back. Sturdy steel frame and armrests.

- Easy-clean, antimicrobial vinyl seat with handsome, fabric-upholstered back.
- Oversized option for a roomy, 27" wide seat.



**Tables** – Stylish, 1" thick laminate top resists scratches and spills. Sturdy steel frame with leveling feet.



**CHAIRS** SPECIFY COLOR: Blue/Gray, Black/Brown or Black/Gray

MODEL NO.	DESCRIPTION	SEAT DIM. W x D	CAP. (LBS.)	SEAT HEIGHT	WT. (LBS.)	PRICE EACH	
						1	2+
H-9131	Standard	21 x 21"	300	19"	34	\$225	\$215
H-9132	Oversized	27 x 21"	450		38	290	280

EASY ASSEMBLY. SHIPS VIA UPS.

**TABLES** SPECIFY COLOR: Gray or Espresso

MODEL NO.	DESCRIPTION	DIMENSIONS L x W x H	WT. (LBS.)	PRICE EACH	
				1	2+
H-9769	End Table	24 x 24 x 20"	30	\$145	\$135
H-9770	Coffee Table	48 x 24 x 16"	50	175	165

EASY ASSEMBLY. SHIPS VIA UPS.

# MOBILE FABRIC PARTITIONS

Roll in, roll out. Quickly divide spaces in libraries, training centers and classrooms.

- Durable steel frame with 3" locking swivel casters.
- 1 5/8" thick polyester fabric panels. Tackable material for graphics and flyers.
- Foam-padded MDF core absorbs sound in noisy areas.

**Partition With Window** – Crystal clear acrylic window allows visibility.

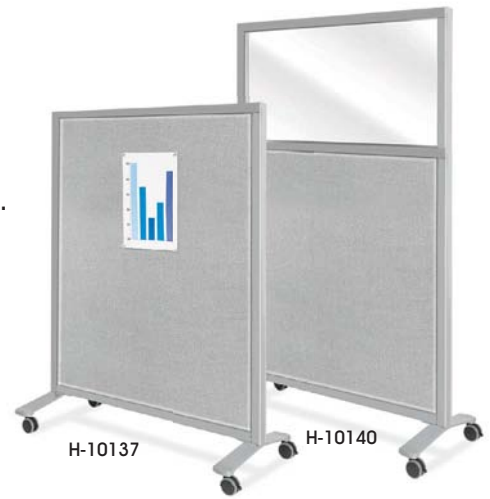

PARTITION MODEL NO.	DIMENSIONS W x H	WT. (LBS.)	COLOR: Gray	
			PRICE EACH	
			1	2+
H-10137	48 x 64"	59	\$475	\$455
H-10138	48 x 76"	71	515	495

SHIPS UNASSEMBLED VIA MOTOR FREIGHT

PARTITION WITH WINDOW MODEL NO.	DIMENSIONS W x H	WT. (LBS.)	COLOR: Gray	
			PRICE EACH	
			1	2+
H-10139	48 x 64"	56	\$495	\$475
H-10140	48 x 76"	66	535	515

SHIPS UNASSEMBLED VIA MOTOR FREIGHT

# MODULAR SOFT SEATING New

Funky and comfy. Recommended for lounges, school libraries, dorms and breakout spaces.

- Fits like a puzzle! Unlimited arrangement options to fit your workplace.
- Sturdy base with durable fabric over plush foam padding.
- Lightweight for quick and easy reconfiguration.



SHAPE YOUR SPACE

Popular in educational and corporate settings.

MODEL NO.	SHAPE	DIMENSIONS W x D x H	CAP. (LBS.)	WT. (LBS.)	SPECIFY COLOR: Blue or Gray	
					PRICE EACH	
					1	4+
H-10256	Round	17" Diam. x 19" H	275	10	\$160	\$150
H-10257	Trapezoid	16 x 16 x 19"		12	160	150
H-10258		32 x 16 x 19"	22	280	265	

SHIPS ASSEMBLED VIA UPS

# PADDED STACK CHAIRS New



Comfortable flex back. Sit through lengthy presentations.

- 1 1/2" thick fabric padded seat and flexible, contoured plastic back.
- Strong powder-coated steel legs with non-marring glides.
- Stacks up to 4 high for storage.

SOLD IN CARTON QUANTITIES SPECIFY COLOR: White/Blue or Black/Black

MODEL NO.	SEAT DIMENSIONS W x D	CAPACITY (LBS.)	SEAT HEIGHT	QTY./ CTN.	PRICE PER CHAIR	
					4	20+
					H-10259	19 x 17"

EASY ASSEMBLY. SHIPS VIA MOTOR FREIGHT.

# LEATHER BUCKET CHAIRS New

Cradled in comfort. Luxury design for hotels and conference rooms.

- Classic mid-back bucket seat with padded armrests.
- Super-soft bonded leather over 4" thick molded foam seat.
- Chrome-plated steel base.



SPECIFY COLOR: Gray or Black

MODEL NO.	SEAT DIMENSIONS W x D	CAPACITY (LBS.)	ADJUSTABLE HEIGHT	WT. (LBS.)	PRICE EACH	
					1	2+
					H-10267	20 x 19"

EASY ASSEMBLY. SHIPS VIA UPS.



ENDLESS CONFIGURATIONS





## CONFERENCE TABLES



Bold, spacious tables for boardroom meetings and creative brainstorming.

- Heavy-duty steel frame with rectangle tube legs and leveling feet.
- Durable, 1½" thick laminate top with PVC edges. 30" table height.

### STANDARD

COLOR: Walnut

MODEL NO.	SHAPE	DIMENSIONS L x W	SEATING CAPACITY	WT. (LBS.)	PRICE EACH	
					1	2+
H-10276	Rectangle	96 x 48"	8	150	\$895	\$855
H-10277		144 x 48"	12	223	1,265	1,210
H-10278		192 x 48"	16	295	1,625	1,565

SHIPS UNASSEMBLED VIA MOTOR FREIGHT

### POWERED – Pop-up power center: 4 outlets/4 USB ports

COLOR: Walnut

MODEL NO.	SHAPE	DIMENSIONS L x W	SEATING CAPACITY	WT. (LBS.)	PRICE EACH	
					1	2+
H-10279	Rectangle	96 x 48"	8	154	\$1,045	\$1,000
H-10280		144 x 48"	12	227	1,425	1,360
H-10281		192 x 48"	16	304	1,875	1,800

SHIPS UNASSEMBLED VIA MOTOR FREIGHT

## HON® IGNITION CHAIRS



Personalize your comfort with this popular American brand.

- Long-lasting, 3½" thick molded foam seat with durable fabric.
- Adjustable, padded armrests.
- Seat slider accommodates all heights. Spacious backrest.

### IGNITION 2.0

SPECIFY COLOR: ■ Blue ■ Red ■ Black

MODEL NO.	SEAT DIM. W x D	CAPACITY (LBS.)	ADJUSTABLE HEIGHT	WT. (LBS.)	PRICE EACH	
					1	2+
H-7057	20 x 18"	300	18-23"	48	\$535	\$525

EASY ASSEMBLY. SHIPS VIA UPS.

## ULINE PINNACLE CHAIRS

Sit in style. Modern design paired with comfort and quality.

- Long-lasting, 3½" thick molded foam seat with mesh upholstery.
- Weight-sensitive tilt tension.
- Adjustable lumbar support, seat slider and padded armrests.



SPECIFY COLOR: ■ Black ■ Green ■ Red

MODEL NO.	SEAT DIM. W x D	CAPACITY (LBS.)	ADJUSTABLE HEIGHT	WT. (LBS.)	PRICE EACH	
					1	2+
H-9729	19 x 20"	300	19-23"	43	\$305	\$295

EASY ASSEMBLY. SHIPS VIA UPS.

## OFFICE STORAGE



H-10303

Complete your office space with matching storage.

- Durable laminate surface resists scratches and stains.

**Lateral File** – 2 full-extension drawers for letter or legal-size documents. Lockable.

**Credenza** – Store supplies and display décor.

Bookcases and Storage Cabinets, see [uline.com](http://uline.com)



H-10306

### LATERAL FILE CABINET

COLOR: Walnut

MODEL NO.	DESCRIPTION	DIMENSIONS W x D x H	WT. (LBS.)	PRICE EACH	
				1	2+
H-10303	Lateral File Cabinet	36 x 22 x 30"	141	\$525	\$505

SHIPS ASSEMBLED VIA MOTOR FREIGHT

### CREDENZAS

COLOR: Walnut

MODEL NO.	DESCRIPTION	DIMENSIONS W x D x H	WT. (LBS.)	PRICE EACH	
				1	2+
H-10306	Double Cabinet	74 x 22 x 30"	255	\$795	\$765
H-10307	Lateral File and Cabinet		304	955	920

SHIPS UNASSEMBLED VIA MOTOR FREIGHT

# METRO COLLECTION

## OFFICE DESKS



H-9779  
With optional 3-Drawer  
Mobile Pedestal File

Strong, sleek design. For ad agencies, design studios and urban office spaces.

- Durable, 1½" thick laminate top with PVC edges and cable grommets. 30" height.
- Heavy-duty steel frame with rectangle tube legs and full-length modesty panel.

L-Desk – Offers extra workspace. Adjusts for left or right-hand configuration.



COLOR: Walnut

MODEL NO.	DESCRIPTION	DIMENSIONS L x W	WT. (LBS.)	PRICE EACH	
				1	2+
H-10353	Desk	48 x 24"	89	\$425	\$400
H-9778		60 x 24"	100	475	445
H-10354		60 x 30"	109	515	490
H-9779		72 x 30"	125	555	530

SHIPS UNASSEMBLED VIA MOTOR FREIGHT

COLOR: Walnut

MODEL NO.	DESCRIPTION	DIMENSIONS L x W	WT. (LBS.)	PRICE EACH	
				1	2+
H-9780	L-Desk	60 x 72"	181	\$750	\$725
H-10356		72 x 72"	176	790	765
H-9781		72 x 78"	206	830	805

SHIPS UNASSEMBLED VIA MOTOR FREIGHT

## MOBILE PEDESTAL FILES

COLOR: Walnut

MODEL NO.	DESCRIPTION	DIMENSIONS W x D x H	WT. (LBS.)	PRICE EACH	
				1	2+
H-9784	2-Drawer	16 x 22 x 28"	62	\$240	\$230
H-9785	3-Drawer		67	260	250

SHIPS UNASSEMBLED VIA MOTOR FREIGHT

Companion storage fits under Metro Office Desks.

- 5 swivel casters, 2 locking.
- 2-Drawer** – 2 file drawers.
- 3-Drawer** – 1 file drawer, 2 box drawers.



## OFFICE TABLES

Stylish and functional. Ready for group meetings and breakout discussions.

- Durable, 1½" thick laminate top with protected PVC edges. 30" height.
- Heavy-duty steel frame with rectangle tube legs.
- Adjustable leveling feet.

COLOR: Walnut

MODEL NO.	DESCRIPTION	DIMENSIONS L x W	WT. (LBS.)	PRICE EACH	
				1	2+
H-9775	Table	60 x 30"	80	\$455	\$430
H-9776		72 x 36"	102	535	510

SHIPS UNASSEMBLED VIA MOTOR FREIGHT



## ADJUSTABLE HEIGHT L-DESKS

Get up for good health. Desk return transitions from sitting to standing in seconds.

- Simple-to-use push-button control with 4 programmable heights.
- Return adjusts from 30 to 48" high.
- 3 cable grommets.
- 9' power cord.
- Powered by 2 quiet electric motors.



COLOR: Walnut

MODEL NO.	DESCRIPTION	DIMENSIONS L x W	WT. (LBS.)	PRICE EACH	
				1	2+
H-10357	Adjustable Height	60 x 72"	250	\$1,215	\$1,185
H-10358		72 x 78"	270	1,315	1,280

SHIPS UNASSEMBLED VIA MOTOR FREIGHT

# COLLABORATION TABLES



Dual Workstation

Contemporary tables for offices that embrace interaction and teamwork.

- 1" thick white laminate top with impact-resistant PVC edges. 30" height.
- Trapezoid legs with black powder-coated finish.
- Leveling feet prevent wobble.



Single Workstation

**Standing Workstation –** Designed for weekly progress meetings or group projects.

- 42" table height.



**Dual Workstation –** For face-to-face collaboration. Optional frosted privacy panel.

MODEL NO.	DESCRIPTION	DIMENSIONS L x W	WT. (LBS.)	PRICE EACH	
				1	2+
H-7786	Single Workstation	60 x 30"	88	\$445	\$430
H-8258		72 x 30"	96	490	475
H-7787	Dual Workstation	60 x 60"	158	675	655
H-8259	Standing Workstation	72 x 36"	117	605	585
H-7788	Privacy Panel for Dual Workstation		13	155	150

SHIPS UNASSEMBLED VIA MOTOR FREIGHT

## WHITE LATERAL FILE CABINETS



Fresh, modern look.

- Full-extension locking drawers. Durable steel.
- Full-width drawer pulls.
- Additional sizes, see page 559.

MODEL NO.	DESCRIPTION	NO. OF DRAWERS	DIMENSIONS W x D x H	WT. (LBS.)	PRICE EACH	
					1	2+
H-2739	Letter/	2	36 x 18 x 28"	110	\$565	\$545
H-2169	Legal	4	36 x 18 x 54"	162	890	870

SHIPS ASSEMBLED VIA MOTOR FREIGHT

## MOBILE PEDESTAL FILES

Compact storage fits neatly under Collaboration Tables.

- Full-extension locking drawers. Durable steel.
- 4 hidden casters.

**H-8261 –** 2" black vinyl seat cushion. 250 lb. capacity.



SPECIFY COLOR: White or Black

MODEL NO.	DESCRIPTION	DIMENSIONS W x D x H	WT. (LBS.)	PRICE EACH	
				1	2+
H-8260	2-Drawer	15 x 20 x 22"	50	\$240	\$230
H-8261	2-Drawer w/ Cushion	15 x 20 x 24"	55	305	290

SHIPS ASSEMBLED VIA MOTOR FREIGHT

## LOUNGE CHAIR

Comfy, contoured and spacious for waiting rooms and lounge areas.

- Durable fabric upholstery with padded foam seat.
- 2½" thick seat and back.
- Chrome-plated steel sled frame.



MODEL NO.	SEAT DIM. W x D	CAPACITY (LBS.)	SEAT HEIGHT	WT. (LBS.)	PRICE EACH	
					1	2+
H-9066	26 x 19"	275	19"	26	\$210	\$200

EASY ASSEMBLY. SHIPS VIA UPS.

## FASHION CHAIRS

Take your seat in style. Clean, sleek design for modern offices.

- Ribbed bonded leather upholstery. Foam padding.
- 2½" thick seat and back.
- Chrome-plated steel arms and base.



SPECIFY COLOR: White, Black, Red or Brown

MODEL NO.	SEAT DIM. W x D	CAPACITY (LBS.)	ADJUSTABLE HEIGHT	WT. (LBS.)	PRICE EACH	
					1	2+
H-4120	21 x 18"	275	18-22"	42	\$235	\$225

EASY ASSEMBLY. SHIPS VIA UPS.



# DESIGNER COLLECTION

## OFFICE DESKS

Brighten up your workplace. Minimalist style for modern and trendy offices.

- 1" thick elevated laminate top with PVC edges and 2 cable grommets. 30" height.
- Durable white steel frame with beveled legs and hanging modesty panel.



H-9795  
With optional Mobile Pedestal File

SPECIFY COLOR:  White  Maple

MODEL NO.	DESCRIPTION	DIMENSIONS L x W	WT. (LBS.)	PRICE EACH	
				1	2+
H-9790	Desk	48 x 24"	60	\$345	\$330
H-10260		60 x 24"	72	400	385
H-9795		60 x 30"	80	430	415
H-10261		72 x 30"	90	465	445

SHIPS UNASSEMBLED VIA MOTOR FREIGHT

## L-DESKS



Shown with optional Mobile Pedestal File

Extra space to get work done. Spread out your projects, reports or creative materials.

- Return adjusts for left or right-hand configuration.
- 3 cable grommets.
- Hanging modesty panel for privacy.

SPECIFY COLOR:  White  Maple

MODEL NO.	DESCRIPTION	DIMENSIONS L x W	WT. (LBS.)	PRICE EACH	
				1	2+
H-9800	L-Desk	60 x 66"	115	\$610	\$590
H-10262		72 x 66"	125	700	675

SHIPS UNASSEMBLED VIA MOTOR FREIGHT

## MOBILE PEDESTAL FILES

Companion storage tucks away neatly underneath Designer Office Desks.

SPECIFY COLOR:  White  Maple

MODEL NO.	DESCRIPTION	DIMENSIONS W x D x H	WT. (LBS.)	PRICE EACH	
				1	2+
H-9806	3-Drawer	16 x 18 x 26"	56	\$230	\$220

SHIPS UNASSEMBLED VIA MOTOR FREIGHT

- 1 file drawer, 2 box drawers.
- 5 swivel casters, 2 locking.



## OFFICE STORAGE New

Complete your bright, modern look with matching storage.

- Durable laminate surface resists scratches, stains and spills.

**Bookcases** – Store books and binders. Adjustable shelves.

**Lateral File** – 2 drawers for letter or legal-size documents. Lockable.



SPECIFY COLOR:  White  Maple

MODEL NO.	DESCRIPTION	DIMENSIONS W x D x H	WT. (LBS.)	PRICE EACH	
				1	2+
H-10250	3-Shelf	32 x 14 x 47"	99	\$185	\$175
H-10251	5-Shelf	32 x 14 x 71"	137	255	245

SHIPS UNASSEMBLED VIA MOTOR FREIGHT

SPECIFY COLOR:  White  Maple

MODEL NO.	DESCRIPTION	DIMENSIONS W x D x H	WT. (LBS.)	PRICE EACH	
				1	2+
H-10252	2-Drawer	36 x 22 x 30"	155	\$445	\$430

SHIPS ASSEMBLED VIA MOTOR FREIGHT

# INDUSTRIAL STEEL DESKS



Upscale design built tough. Reward your warehouse manager after a good year.

- Handsome laminate top resists scratches, stains and spills. 2 cable grommets. 30" height.
- Powder-coated steel base with modesty panel and enclosed sides.
- Lockable pedestal files and center drawer.
- Leveling feet prevent wobble.

COLOR: Gray Top/Black Base

MODEL NO.	DESCRIPTION	DIMENSIONS L x W	WT. (LBS.)	PRICE EACH	
				1	2+
H-9730	Desk	66 x 30"	196	\$870	\$850

SHIPS UNASSEMBLED VIA MOTOR FREIGHT

# INDUSTRIAL STEEL L-DESK

Offers extra workspace to spread out reports, blueprints or work orders.

- Return portion conveniently adjusts for left or right-hand configuration.

COLOR: Gray Top/Black Base

MODEL NO.	DESCRIPTION	DIMENSIONS L x W	WT. (LBS.)	PRICE EACH	
				1	2+
H-9731	L-Desk	66 x 78"	260	\$1,250	\$1,225

SHIPS UNASSEMBLED VIA MOTOR FREIGHT

- 3 grommets for cord management.



# PINNACLE GUEST CHAIRS

Contemporary guest seating for offices, lobbies and seminar rooms.

- 3" thick molded foam seat with fabric upholstery.
- Tilting, breathable mesh back. • Steel frame with powder-coat finish.
- Stack up to 4 high.

Mobile – Includes 2" swivel casters.

SPECIFY SEAT COLOR: Black or Red

MODEL NO.	DESCRIPTION	SEAT DIM. W x D	CAP. (LBS.)	SEAT HEIGHT	QTY./CTN.	PRICE/CHAIR	
						2	8+
H-9748	Stationary	19 x 20"	300	19"	2	\$170	\$160
H-9749	Mobile	19 x 20"	300	19"	2	180	170

SOLD IN CARTON QUANTITIES

SHIPS ASSEMBLED VIA MOTOR FREIGHT

# VINYL TASK CHAIRS



Share seats, not germs. Used in schools, labs and hospitals.

- 3" thick molded foam seat with vinyl upholstery.
- Antimicrobial vinyl inhibits bacteria and wipes clean.
- Adjustable back height and tilt.

H-9727 – With adjustable armrests.

SPECIFY COLOR: Black or Blue

MODEL NO.	DESCRIPTION	SEAT DIM. W x D	CAP. (LBS.)	ADJUSTABLE HEIGHT	WT. (LBS.)	PRICE EACH	
						1	2+
H-9726	Chair	19 x 20"	275	18-22"	38	\$225	\$215
H-9727	Chair w/ Arms	19 x 20"	275	18-22"	46	255	245

EASY ASSEMBLY. SHIPS VIA UPS.

# DELUXE LEATHER CHAIRS

New

The Captain's chair. Spacious, first-class seating with sporty style.

- 6" thick molded foam seat with bonded leather upholstery.
- Comfortable high-back design with adjustable headrest.
- Padded armrests flip up and out of the way to scoot in.



SPECIFY COLOR: Black or Gray

MODEL NO.	SEAT DIM. W x D	CAPACITY (LBS.)	ADJUSTABLE HEIGHT	WT. (LBS.)	PRICE EACH	
					1	2+
H-10249	21 x 20"	300	20-24"	53	\$300	\$285

EASY ASSEMBLY. SHIPS VIA UPS.

# ADJUSTABLE HEIGHT DESKS

Stand more and sit less for improved comfort and circulation.

- Simple-to-use push-button control with 4 programmable heights.
- Telescoping legs adjust from 28½ to 48" high.
- Powered by 2 quiet electric motors. 10' power cord.
- Durable, 1" thick laminate top. 2 cable grommets.



SPECIFY TOP COLOR: Mahogany, Gray or White

MODEL NO.	DESCRIPTION	DIMENSIONS L x W	CAPACITY (LBS.)	WT. (LBS.)	PRICE EACH	
					1	2+
H-7033	Desk	48 x 24"	275	99	\$680	\$660
H-8362		48 x 30"		104	710	690
H-7034	Desk	60 x 24"	275	107	705	685
H-7598		60 x 30"		115	735	715

SHIPS UNASSEMBLED VIA MOTOR FREIGHT

ELECTRIC



SPECIFY TOP COLOR: Mahogany, Gray or White

MODEL NO.	DESCRIPTION	DIMENSIONS L x W	CAPACITY (LBS.)	WT. (LBS.)	PRICE EACH	
					1	2+
H-7035	Desk	72 x 24"	275	113	\$745	\$725
H-7599		72 x 30"		125	770	750

SHIPS UNASSEMBLED VIA MOTOR FREIGHT



## ADJUSTABLE HEIGHT L-DESKS

ELECTRIC

Extra space lets you spread out your work.

- Left-hand return maximizes office space.

SPECIFY TOP COLOR: Mahogany, Gray or White

MODEL NO.	DESCRIPTION	DIMENSIONS L x W	CAPACITY (LBS.)	WT. (LBS.)	PRICE EACH	
					1	2+
H-8367	L-Desk	60 x 60"	275	160	\$1,085	\$1,060
H-8368		72 x 72"		170	1,115	1,090

SHIPS UNASSEMBLED VIA MOTOR FREIGHT

# ADJUSTABLE HEIGHT DESKS New

No power necessary, no messy cords. Switch from sitting to standing in seconds.

SPECIFY TOP COLOR: Mahogany or Gray

MODEL NO.	DESCRIPTION	DIMENSIONS L x W	CAPACITY (LBS.)	WT. (LBS.)	PRICE EACH	
					1	2+
H-10243	Desk	60 x 30"	150	109	\$430	\$415
H-10244		72 x 30"		119	465	450

SHIPS UNASSEMBLED VIA MOTOR FREIGHT

- Pneumatic lift lever smoothly adjusts height.
- 2 cable grommets.

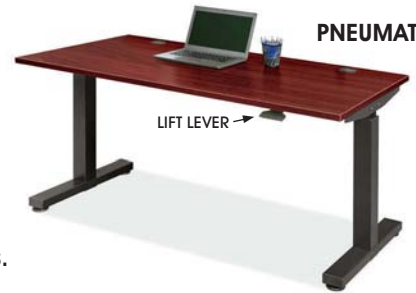

PNEUMATIC

# PORTABLE ROOM DIVIDERS



Create meeting areas, offices and classrooms at a moment's notice.

- ¾" thick, sound absorbing, tackable fabric panels are stain resistant.
- Full-length hinges hold panels straight or at any angle.
- Rolls smoothly on self-leveling casters. Locking corner casters.
- Link end-to-end for longer runs. No additional hardware necessary.
- More colors and sizes available, call for quote.



SPECIFY COLOR: Gray or Black

MODEL NO.	DESCRIPTION	NUMBER OF PANELS	DIMENSIONS W x H	WT. (LBS.)	PRICE EACH	
					1	2+
H-5862	Portable Dividers	7	13 x 6'	121	\$1,550	\$1,490
H-5863		11	20½ x 6'	151	2,080	1,990

3 YEAR WARRANTY

SHIPS ASSEMBLED VIA MOTOR FREIGHT



# SIT/STAND DESKTOP RISERS

Help relieve an aching back or boost employee productivity. Position to fit any height.



Lifts straight up and down



H-7031

- Transitions easily from sitting to standing with side lever and gas lift assistance.
- Sits on desktop. Height adjusts 6-20".
- 5/8" thick scratch-resistant laminate.

## MANUAL

\* SPECIFY COLOR: Black or White

MODEL NO.	DESCRIPTION	RECOMMENDED USE	DIMENSIONS W x D	CAP. (LBS.)	WT. (LBS.)	PRICE EACH	
						1	2+
H-6306	Small	Portable Laptops	27 x 31"	35	43	\$330	\$320
H-6307*	Medium	Workstations	35 x 31"	35	51	360	350
H-7030	Large	Dual Monitors	47 x 31"	45	67	420	405
H-7031	Corner	Cubicles	42 x 31"	35	60	420	405

EASY ASSEMBLY. SHIPS VIA UPS.

# OFFICE STOOLS

Comfortable seating for drafting tables and service counters.



- 3½" thick molded foam seat with fabric upholstery.
- Flexible and contoured backrest.
- Adjustable seat height, footring and padded armrests.

## FABRIC

SPECIFY SEAT COLOR: Black or Red

MODEL NO.	SEAT DIMENSIONS W x D	CAPACITY (LBS.)	ADJUSTABLE HEIGHT	WT. (LBS.)	PRICE EACH	
					1	3+
H-7589	19 x 17"	300	25-35"	33	\$240	\$230

EASY ASSEMBLY. SHIPS VIA UPS.

# SIT/STAND MOBILE DESK

Easily rolls along with you. Used in schools, offices and hospitals.



- Extra large laminate work surface with underside shelf.
- Easy pneumatic lift adjusts height from 27-42".
- Sturdy aluminum frame with 4 swivel casters, 2 locking.

MODEL NO.	SHAPE	DIMENSIONS L x W	CAPACITY (LBS.)	WT. (LBS.)	PRICE EACH	
					1	2+
H-9014	Rectangle	30 x 22"	65	28	\$245	\$235

SHIPS UNASSEMBLED VIA UPS

# PLASTIC STACKABLE CHAIRS

Tough enough for the rowdiest breakroom or cafeteria.

- Contoured plastic back and seat with waterfall edge.
- Stacks up to 5 high for convenient storage.
- Chrome finish steel frame with connector brackets.



SOLD IN CARTON QUANTITIES

SPECIFY COLOR: Black, White or Blue

MODEL NO.	SEAT DIMENSIONS W x D	CAPACITY (LBS.)	SEAT HEIGHT	QTY./CTN.	PRICE PER CHAIR	
					4	20+
H-5678	18 x 17"	300	18"	4	\$70	\$65

SHIPS ASSEMBLED VIA MOTOR FREIGHT

# MESH NESTING CHAIRS

Set up in seconds. For meetings, seminars and temporary classrooms.

- Padded mesh upholstered seat and contoured screen back.
- 2½" thick seat flips up to nest for storage.
- 2" swivel casters.
- Powder-coated steel frame.



SOLD IN CARTON QUANTITIES

SPECIFY SEAT COLOR: Black or Gray

MODEL NO.	DESCRIPTION	SEAT DIM. W x D	CAP. (LBS.)	SEAT HEIGHT	QTY./CTN.	PRICE PER CHAIR	
						2	8+
H-6929	Mesh	18 x 19"	275	19"	2	\$180	\$170
H-6930	Mesh w/ Armrests					190	180

SHIPS ASSEMBLED VIA MOTOR FREIGHT



# MOBILE TRAINING TABLES

## STANDARD

Turn any conference room into an employee workshop or seminar.

- Laminate surface resists scratches, stains and spills. 29½" height.
- 2 grommets for cable management. • One flip lever.
- Powder-coated steel frame. 3" locking swivel casters.



Tables nest when not in use

Top flips up 90° for compact storage

SPECIFY TOP COLOR: Mahogany or Gray

MODEL NO.	SHAPE	DIMENSIONS L x W	CAPACITY (LBS.)	WT. (LBS.)	PRICE EACH	
					1	4+
H-6278	Rectangle	48 x 24"	250	53	\$280	\$270
H-6279		60 x 24"		61	330	320
H-6280		72 x 24"		68	355	345

SHIPS UNASSEMBLED VIA MOTOR FREIGHT

## ECONOMY



Top flips up 90° for compact storage

Lightweight and portable for college classrooms and multi-use areas.

- Blow-molded plastic top. 29½" height. • Tables nest when not in use.
- 2 grommets for cable management. • Powder-coated steel frame.
- 2" locking swivel casters.

MODEL NO.	SHAPE	DIMENSIONS L x W	CAPACITY (LBS.)	WT. (LBS.)	PRICE EACH	
					1	4+
H-6932	Rectangle	60 x 24"	250	46	\$235	\$225
H-6933		72 x 24"		51	270	260

SHIPS UNASSEMBLED VIA MOTOR FREIGHT

## ADJUSTABLE HEIGHT

PNEUMATIC

Work where you want and at the height you want.

- Durable, 1" thick laminate top with 2 cable grommets. Locking casters.
- Pneumatic lift lever for smooth height adjustments. No power necessary.

SPECIFY TOP COLOR: Mahogany or Gray

MODEL NO.	SHAPE	DIMENSIONS L x W	CAPACITY (LBS.)	WT. (LBS.)	PRICE EACH	
					1	2+
H-8970	Rectangle	48 x 24"	150	95	\$370	\$355
H-7704		60 x 24"		109	405	390
H-7705		72 x 24"		119	440	425

SHIPS UNASSEMBLED VIA MOTOR FREIGHT



Telescoping legs adjust from 30 to 43" high

## DELUXE

Turn conference rooms into training rooms with a quick flip.

- Attractive laminate surface with 2 cable grommets. 29½" height.
- Durable, powder-coated steel frame with 300 lb. capacity.
- Full-length flip lever. • 3" swivel casters, 2 locking.

SPECIFY TOP COLOR: White or Espresso

MODEL NO.	SHAPE	DIMENSIONS L x W	CAPACITY (LBS.)	WT. (LBS.)	PRICE EACH	
					1	4+
H-7775	Rectangle	60 x 24"	300	92	\$445	\$430
H-7776		72 x 24"		105	470	455

SHIPS UNASSEMBLED VIA MOTOR FREIGHT



Tables nest when not in use

Convenient underside storage shelf

# BOOKCASES



Holds books, catalogs and binders.

- Shelves adjust in 2" increments.
- Raised base.

**Assembled** – All-welded, 22-gauge steel.

**Unassembled** – Easy assembly. No hardware needed. 19-gauge steel.

**18" Deep** – Easily fits legal documents and binders up to 150 lbs. per shelf.



H-6972

## ASSEMBLED

SPECIFY COLOR: Tan, Black or Lt. Gray

MODEL NO.	NO. OF SHELVES	DIMENSIONS W x D x H	SHELF CAP. (LBS.)	WT. (LBS.)	PRICE EACH	
					1	2+
H-2925	2	35 x 14 x 28"	120	33	\$195	\$185
H-2806	3	35 x 14 x 40"		47	230	220
H-2926	4	35 x 14 x 53"		59	295	285
H-2927	5	35 x 14 x 66"		73	355	340
H-2807	6	35 x 14 x 78"		90	410	395
H-3610	3	36 x 18 x 43"	150	58	340	325
H-3611	6	36 x 18 x 84"		111	510	490

SHIPS ASSEMBLED VIA MOTOR FREIGHT

## UNASSEMBLED

Black Only

MODEL NO.	NO. OF SHELVES	DIMENSIONS W x D x H	SHELF CAP. (LBS.)	WT. (LBS.)	PRICE EACH	
					1	2+
H-6972	3	35 x 13 x 42"	120	60	\$190	\$180
H-6973	4	35 x 13 x 52"		77	225	215
H-6974	5	35 x 13 x 72"		94	280	270
H-7689	6	35 x 13 x 84"		111	320	310

SHIPS UNASSEMBLED VIA MOTOR FREIGHT

Additional shelves available, see [uline.com](http://uline.com)



# MOBILE PEDESTAL FILES

Keep everyday folders, paperwork and supplies within reach.

- Steel construction with baked enamel finish.
- Full-extension drawers with ball-bearing glides and lock.
- Full-width drawer pulls. • 4 hidden casters: 2 swivel, 2 rigid.

**2-Drawer** – 2 letter-size file drawers.

**3-Drawer** – 2 box drawers and 1 letter-size file drawer.



SPECIFY COLOR: Black or Lt. Gray

MODEL NO.	DESCRIPTION	DIMENSIONS W x D x H	WT. (LBS.)	PRICE EACH	
				1	2+
H-7004	2-Drawer	15 x 20 x 28"	66	\$325	\$315

SHIPS ASSEMBLED VIA MOTOR FREIGHT

SPECIFY COLOR: Black or Lt. Gray

MODEL NO.	DESCRIPTION	DIMENSIONS W x D x H	WT. (LBS.)	PRICE EACH	
				1	2+
H-7005	3-Drawer	15 x 20 x 28"	71	\$325	\$315

SHIPS ASSEMBLED VIA MOTOR FREIGHT

# STEEL DESKS

Strong, sturdy and built to last. Versatile for any office or warehouse.

- Laminate top resists scratches, stains and spills. 30" height.
- Powder-coated steel base. Leveling feet prevent wobble.
- Central locking system. Includes 2 keys.

**L-Desk** – Offers extra workspace.

COLOR: Walnut Top/Black Base

MODEL NO.	DESCRIPTION	DIMENSIONS L x W	WT. (LBS.)	PRICE EACH	
				1	2+
H-7829	Single Pedestal	48 x 30"	110	\$680	\$660
H-5685	Double Pedestal	60 x 30"	150	800	780
H-8204	Double Pedestal L-Desk	66 x 72"	250	1,300	1,275

EASY ASSEMBLY. SHIPS VIA MOTOR FREIGHT.



DOUBLE PEDESTAL



L-DESK



# FILE CABINETS

IN STOCK – SHIPS TODAY



H-1915



H-1914

## VERTICAL

Easy access to important documents.

- Full-extension drawers with locks included.
- High side walls hold hanging files.
- Thumb latch prevents accidental opening.

**Legal** – Holds 8½ x 14" paper and files.

## LATERAL

Space saving. Use for letter or legal-size documents.

- Full-extension drawers with locks included.
- Safety interlock system allows only one drawer to open at a time.

**5 Drawer** – Top drawer has retractable door and rollout shelf.



H-2739

H-6396

H-2169

### VERTICAL

SPECIFY COLOR: Tan, Lt. Gray or Black

MODEL NO.	DESCRIPTION	NO. OF DRAWERS	DIMENSIONS W x D x H	WT. (LBS.)	PRICE EACH	
					1	2+
H-1914	Letter	2	15 x 25 x 29"	50	\$260	\$250
H-6939		3	15 x 25 x 40"	70	325	310
H-1915		4	15 x 25 x 52"	90	345	330
H-3705		5	15 x 25 x 64"	110	505	485
H-6365	Legal	2	18 x 25 x 29"	67	335	320
H-6366		4	18 x 25 x 52"	122	430	415
H-7803		5	18 x 25 x 64"	130	585	565

SHIPS ASSEMBLED VIA MOTOR FREIGHT

### LATERAL

SPECIFY COLOR: Tan, Lt. Gray or Black

MODEL NO.	DESCRIPTION	NO. OF DRAWERS	DIMENSIONS W x D x H	WT. (LBS.)	PRICE EACH	
					1	2+
H-2739*	Letter/ Legal	2	36 x 18 x 28"	110	\$565	\$545
H-1916*		3	36 x 18 x 41"	140	705	685
H-2169*		4	36 x 18 x 54"	162	890	870
H-3706*		5	36 x 18 x 65"	245	1,165	1,140
H-6393	Letter/ Legal	2	42 x 18 x 28"	118	680	660
H-6394		3	42 x 18 x 41"	174	860	840
H-6395		4	42 x 18 x 54"	220	1,090	1,065
H-6396		5	42 x 18 x 65"	275	1,310	1,275

\*Also available in White

SHIPS ASSEMBLED VIA MOTOR FREIGHT

### FILE CABINET DOLLIES

SPECIFY COLOR: Lt. Gray or Black

MODEL NO.	FITS CABINET W x D	USE WITH	WT. (LBS.)	CAP. (LBS.)	PRICE EACH	
					1	2+
H-3612	15 x 25"	Vertical	20	1,000	\$68	\$65
H-6379	18 x 25"		26		76	73
H-2461	36 x 18"	Lateral	22	1,000	82	78
H-6380	42 x 18"		33		93	88

EASY ASSEMBLY. SHIPS VIA UPS.

### FILE CABINET DOLLIES

Move file cabinets with ease.

- Sturdy steel frame. 4 locking swivel casters.



FIREKING®

## FIRE-RESISTANT FILE CABINETS

Total protection for critical business documents. UL Class 350 rated at 1,700°F for 1 hour.

- High-security lock resists picking and drilling. Lock all or select drawers with one key.
- Impact, explosion and water resistant.
- Gypsum insulated walls reinforced with 14-gauge welded steel wire.
- Accepts letter/legal hanging folders.



### VERTICAL

SPECIFY COLOR: Lt. Gray or Black

MODEL NO.	DESCRIPTION	NO. OF DRAWERS	DIMENSIONS W x D x H	WT. (LBS.)	PRICE EACH	
					1	2+
H-4805	Letter/ Legal	2	18 x 22 x 28"	251	\$1,155	\$1,125
H-4806		4	18 x 22 x 53"	435	1,865	1,815

### LATERAL

H-6941	Letter/ Legal	4	31 x 22 x 53"	794	\$4,195	\$4,095
H-7802			38 x 22 x 53"	907	4,685	4,585
H-8190			44 x 22 x 53"	1,019	5,410	5,310

SHIPS ASSEMBLED VIA MOTOR FREIGHT

**BIG AND TALL**



VINYL

FABRIC

FABRIC

## SLED BASE CHAIRS

Welcome guests of all sizes to an attractive lobby or waiting area.

- Comfortable 3" padded seat and back.
- Sturdy steel sled frame with padded armrests.

**Big and Tall** – 4" thick padding and beefed-up frame.

**Vinyl** – Antimicrobial and easy to clean.

**Fabric** – Stain-resistant for a great appearance.

### BIG AND TALL – With Arms

\* SPECIFY COLOR: Black or Burgundy

MODEL NO.	DESCRIPTION	SEAT DIM. W x D	CAP. (LBS.)	SEAT HEIGHT	WT. (LBS.)	PRICE EACH	
						1	4+
H-9128*	Fabric	23 x 21"	400	18"	46	\$260	\$250
H-7820	Vinyl					270	260

EASY ASSEMBLY. SHIPS VIA UPS.

### STANDARD – With Arms

\* SPECIFY COLOR: Black or Burgundy

MODEL NO.	DESCRIPTION	SEAT DIM. W x D	CAP. (LBS.)	SEAT HEIGHT	WT. (LBS.)	PRICE EACH	
						1	4+
H-9129*	Fabric	20 x 19"	250	18"	31	\$160	\$150
H-7822	Vinyl					170	160

EASY ASSEMBLY. SHIPS VIA UPS.

## FLIP-TOP CAFETERIA TABLES New



Set up in a snap! Host events in banquet halls, cafeterias and auditoriums.

- Top flips up for easy cleaning and nestable storage.
- Durable laminate top with powder-coated steel frame.
- Coated edges prevent food traps.
- 3" rubber casters.



SPECIFY COLOR: Walnut Light Gray Maple

MODEL NO.	DESCRIPTION	DIMENSIONS DIAM. x H	SEATING CAPACITY	WT. (LBS.)	PRICE EACH	
					1	2+
H-10333	Round	60 x 29"	8	150	\$1,650	\$1,600

3 YEAR WARRANTY

DROP SHIPS IN 5 DAYS FROM WI ASSEMBLED VIA MOTOR FREIGHT

## MOBILE CAFETERIA TABLES



H-9447



H-9855

Easy up, easy down. Used in school lunchrooms, gymnasiums and breakrooms.

- Instantly lift table to a semi-closed position for easy mopping and sweeping.
- Durable laminate top resists scratches and stains. Powder-coated steel frame.
- Coated edges repel moisture, prevent food traps.

- 4" non-marking rubber casters.
- Bench Seats** – Sit close or spread out.
- Stool Seats** – Easy to get in and out. 13" diameter.



H-9856

### RECTANGLE

SPECIFY COLOR: ■ Walnut ■ Light Gray ■ Maple

MODEL NO.	DESCRIPTION	DIMENSIONS L x W x H	SEATING CAPACITY	WT. (LBS.)	PRICE EACH	
					1	2+
H-9447	Benches	144 x 55 x 29"	12	314	\$1,925	\$1,875
H-9855	Stools					

3 YEAR WARRANTY

DROP SHIPS IN 5 DAYS FROM WI ASSEMBLED VIA MOTOR FREIGHT

### ROUND

SPECIFY COLOR: ■ Walnut ■ Light Gray ■ Maple

MODEL NO.	DESCRIPTION	DIMENSIONS DIAM. x H	SEATING CAPACITY	WT. (LBS.)	PRICE EACH	
					1	2+
H-9856	Stools	60 x 29"	8	320	\$1,875	\$1,825

3 YEAR WARRANTY

DROP SHIPS IN 5 DAYS FROM WI ASSEMBLED VIA MOTOR FREIGHT



Wood – Used in offices and mailrooms. Particle board.

## MAIL SORTERS

Keep mail, office forms and job folders organized and accessible.

- Use on desktops, countertops and floors.
- Stackable up to 3 high.
- 1/2" shelf lip for labeling.



Steel – Recommended for shops and warehouses. Wall mountable.

### WOOD

COLOR: Natural

MODEL NO.	NO. OF MAIL SLOTS	OVERALL DIM. W x D x H	SLOT DIM. W x D x H	WT. (LBS.)	PRICE EACH	
					1	3+
H-4847*	9	35 x 12 x 12"		33	\$240	\$230
H-4848*	12	35 x 12 x 16"		42	265	255
H-4849*	15	35 x 12 x 19"	11 x 11½ x 3"	53	290	280
H-4850	30	35 x 12 x 38"		106	540	525
H-4851	45	35 x 12 x 57"		159	785	760

\* SHIPS ASSEMBLED

SHIPS VIA MOTOR FREIGHT

### STEEL

SPECIFY COLOR: Tan or Black

MODEL NO.	NO. OF MAIL SLOTS	OVERALL DIM. W x D x H	SLOT DIM. W x D x H	WT. (LBS.)	PRICE EACH	
					1	3+
H-2920*	9	34 x 12 x 11"		26	\$125	\$120
H-2921*	12	34 x 12 x 15"		35	160	155
H-2922*	15	34 x 12 x 18"	11 x 11½ x 3"	40	180	175
H-4468	30	34 x 12 x 36"		80	345	335
H-4469	45	34 x 12 x 54"		120	520	505

\* SHIPS ASSEMBLED

SHIPS VIA UPS



## MAIL SORTER WORKSTATIONS

Quickly sort, organize and distribute mail and packages.

- Light gray powder-coated steel construction.
- Adjustable slots hold standard 10 x 13" envelopes.

**Workstation** – Adjustable height table with laminate tabletop. 50-slot sorter, with or without riser.

**Freestanding** – Plenty of slots for the busiest mailrooms. 17" high open base for parcels and postal trays.



H-8349



H-10336

### WORKSTATIONS

MODEL NO.	DESCRIPTION	OVERALL DIM. W x D x H	SLOT DIM. W x D	WT. (LBS.)	PRICE EACH	
					1	2+
H-8348	50 Slots	60 x 30 x 59-67"	11 x 13"	315	\$1,100	\$1,050
H-8349	50 Slots w/ Riser	60 x 30 x 72-80"		357	1,220	1,170

SHIPS UNASSEMBLED VIA MOTOR FREIGHT

### FREESTANDING SORTERS

MODEL NO.	NO. OF MAIL SLOTS	OVERALL DIM. W x D x H	SLOT DIM. W x D	WT. (LBS.)	PRICE EACH	
					1	2+
H-10336	50	60 x 14 x 50"		223	\$740	\$715
H-10337	75	60 x 14 x 65"	11 x 13"	303	995	960
H-10338	100	60 x 14 x 80"		386	1,265	1,215

SHIPS UNASSEMBLED VIA MOTOR FREIGHT

## HON® FABRIC PARTITIONS

Use anywhere. Simple, easy setup dividers for your office, garage, warehouse or shed.

- Powder-coated steel frame with stabilizing T-base feet.
- 1¾" thick polyester fabric panels with MDF core and foam padding.

### 42" HIGH

COLOR: Gray

MODEL NO.	DIMENSIONS W x H	WT. (LBS.)	PRICE EACH	
			1	4+
H-9143	30 x 42"	25	\$390	\$380
H-9144	36 x 42"	27	400	390
H-9145	48 x 42"	37	415	405

### 60" HIGH

COLOR: Gray

MODEL NO.	DIMENSIONS W x H	WT. (LBS.)	PRICE EACH	
			1	4+
H-9146	30 x 60"	36	\$435	\$425
H-9147	36 x 60"	38	445	435
H-9148	48 x 60"	45	455	445

SHIPS VIA MOTOR FREIGHT

- Wipe down with damp cloth or upholstery cleaner.

Choose from 3 heights to fit your space!

### 72" HIGH

COLOR: Gray

MODEL NO.	DIMENSIONS W x H	WT. (LBS.)	PRICE EACH	
			1	4+
H-10041	36 x 72"	48	\$495	\$485
H-10042	48 x 72"	50	515	505

SHIPS VIA MOTOR FREIGHT







## SAFETY ANGLE

Easily walk down steps facing forward – Safety assured. 50° incline.

- Four 4" diameter casters: 2 swivel, 2 rigid.
- 24" wide expanded metal steps. • **450 lb. capacity.**
- Drop ships in 2 days from MI, GA, CA, TX or PA.

OSHA and ANSI Compliant

ASSEMBLED					12" DEEP TOP STEP			24" DEEP TOP STEP		
MODEL NO.	STEPS	PLATFORM HEIGHT	OVERALL HEIGHT	BASE W x D	PRICE EACH		WT. (LBS.)	PRICE EACH		WT. (LBS.)
					1	2+		1	2+	
H-5209*	3	30"	60"	30 x 32"	\$373	\$364	52	\$523	\$514	77
H-3834*	4	40"	70"	30 x 40"	459	451	62	603	593	88
H-3130	5	50"	80"	30 x 51"	590	577	91	723	709	124
H-3131	6	60"	90"	30 x 60"	655	645	120	835	820	143
H-3132	7	70"	100"	30 x 69"	718	699	139	893	872	162
H-3133	8	80"	110"	32 x 78"	896	875	156	1,063	1,041	179
H-3134	9	90"	120"	32 x 88"	976	956	168	1,145	1,120	194
H-3135	10	100"	130"	32 x 97"	1,070	1,053	181	N/A	N/A	N/A

\* 2" spring-loaded swivel casters



## GRIP STEP

Keep your footing when washing tanks or greasing machinery. Works well in factories or warehouses with wet, oily or frosty conditions.

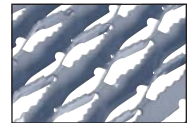

- 24" wide serrated metal steps. • 59° incline.
- Four 4" diameter casters: 2 swivel, 2 rigid. • **450 lb. capacity.**
- Drop ships in 2 days from MI, GA, CA, TX or PA.

OSHA and ANSI Compliant

ASSEMBLED					10" DEEP TOP STEP			20" DEEP TOP STEP		
MODEL NO.	STEPS	PLATFORM HEIGHT	OVERALL HEIGHT	BASE W x D	PRICE EACH		WT. (LBS.)	PRICE EACH		WT. (LBS.)
					1	2+		1	2+	
H-4364*	3	30"	60"	30 x 26"	\$366	\$355	50	\$479	\$471	66
H-4365	5	50"	80"	30 x 40"	597	588	97	712	701	111
H-4366	7	70"	100"	30 x 53"	731	713	121	905	886	135
H-4367	9	90"	120"	32 x 65"	992	972	165	1,158	1,138	184
H-4368	11	110"	140"	32 x 78"	1,106	1,089	188	N/A	N/A	N/A

\* 2" spring-loaded swivel casters



## WORK PLATFORMS

Extra-large platform fits 2 people, toolboxes and tools.

- 50° incline. Easily walk down steps facing forward.
- Rubber pads secure to floor to prevent forward movement.
- Step-and-release pedal to move ladder. • Serrated steps and platform.
- Ships fully assembled. • **800 lb. capacity.**
- Drop ships in 2 days from MI, GA, CA, TX or PA.

OSHA and ANSI Compliant

MODEL NO.	STEPS	PLATFORM W x D	PLATFORM HEIGHT	OVERALL HEIGHT	BASE W x D	PRICE EACH		WT. (LBS.)
						1	2+	
H-1867	3		30"	60"	40 x 55"	\$894	\$877	140
H-1868	4		40"	70"	40 x 63"	989	971	157
H-1869	5	36 x 36"	50"	86"	40 x 70"	1,120	1,102	184
H-4369	6		60"	96"	40 x 78"	1,262	1,241	203
H-4370	7		70"	106"	40 x 87"	1,367	1,346	221

# ROLLING LADDERS

59° angle ladders roll easily through warehouse aisles.

- 3 and 4 step models have four 2" spring-loaded swivel casters.
- 5 to 16 step models have four 4" diameter casters: 2 swivel, 2 rigid.
- 24" wide expanded metal steps. • 450 lb. capacity.
- Drop ships in 2 days from MI, GA, CA, TX or PA.
- Aluminum Rolling Ladders, see [uline.com](http://uline.com)

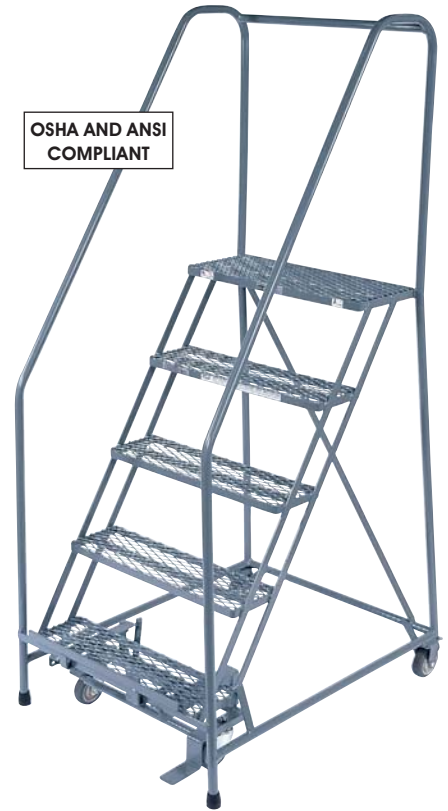

Cal/OSHA regulations require ladders over 48" in platform height to have a 42" handrail.

ASSEMBLED					10" DEEP TOP STEP			20" DEEP TOP STEP		
MODEL NO.	STEPS	PLATFORM HEIGHT	OVERALL HEIGHT	BASE W x D	PRICE EACH		WT. (LBS.)	PRICE EACH		WT. (LBS.)
					1	2+		1	2+	
H-840	3	30"	60"	30 x 26"	\$327	\$318	50	\$427	\$419	66
H-1082	4	40"	70"	30 x 31"	419	408	60	496	484	78
H-841	5	50"	80"	30 x 40"	536	525	97	633	625	111
H-1083	6	60"	90"	30 x 46"	596	588	109	763	751	122
H-843	7	70"	100"	30 x 53"	653	637	121	808	792	135
H-1084	8	80"	110"	32 x 58"	814	796	150	986	970	174
H-842	9	90"	120"	32 x 65"	887	870	165	1,034	1,017	184
H-1085	10	100"	130"	32 x 72"	972	956	173	1,128	1,113	204
H-844	11	110"	140"	32 x 78"	990	972	188	N/A	N/A	N/A
H-1554A	12	120"	162"	32 x 88"	1,290	1,269	215	N/A	N/A	N/A

UNASSEMBLED					10" DEEP TOP STEP			20" DEEP TOP STEP		
MODEL NO.	STEPS	PLATFORM HEIGHT	OVERALL HEIGHT	BASE W x D	PRICE EACH		WT. (LBS.)	PRICE EACH		WT. (LBS.)
					1	2+		1	2+	
H-1082U	4	40"	70"	30 x 33"	\$419	\$408	72	\$496	\$484	94
H-841U	5	50"	80"	30 x 40"	536	525	106	633	625	129
H-1083U	6	60"	90"	30 x 46"	596	588	123	763	751	145
H-843U	7	70"	100"	30 x 53"	653	637	136	808	792	158
H-1084U	8	80"	110"	32 x 58"	814	796	158	986	970	183
H-842U	9	90"	120"	32 x 65"	887	870	170	1,034	1,017	193
H-1085U	10	100"	130"	32 x 72"	972	956	183	1,128	1,113	212
H-844U	11	110"	140"	32 x 78"	990	972	195	1,208	1,187	227
H-1554U	12	120"	162"	32 x 88"	1,290	1,269	310	1,443	1,423	338
H-1555	13	130"	172"	42 x 95"	1,530	1,512	360	1,692	1,669	388
H-1556	14	140"	182"	42 x 101"	1,555	1,530	376	1,718	1,694	413
H-1557	15	150"	192"	42 x 108"	1,649	1,627	394	1,811	1,788	425
H-1558	16	160"	202"	42 x 114"	1,687	1,662	418	1,846	1,822	448

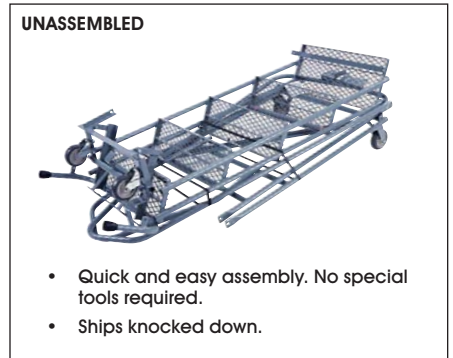
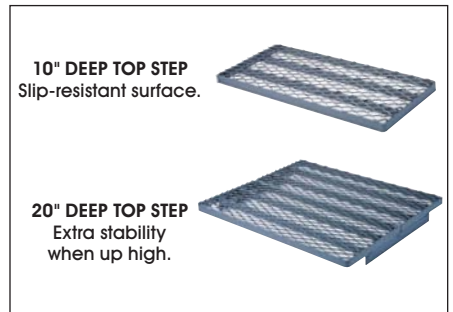

# UTILITY STEP LADDERS

Recommended for speedy relocation around the warehouse, dock and stockroom.

- 16" wide expanded metal steps. • 59° climbing angle.
- Four 2" spring-loaded swivel casters.
- All-welded steel construction.

ASSEMBLED					10" DEEP TOP STEP		
MODEL NO.	STEPS	LOAD CAPACITY	TOP STEP HEIGHT	BASE W x D	PRICE EACH		WT. (LBS.)
					1	2+	
H-2251	2	450 lbs.	20"	18 x 19"	\$234	\$227	24
H-2252	3		30"	20 x 26"	304	293	36

SHIPS VIA UPS





## NARROW AISLE

Slim design fits well when warehouse space is an issue.

- 16" wide expanded metal steps. • 59° incline.
- Four 4" diameter casters: 2 swivel, 2 rigid. • 450 lb. capacity.
- Drop ships in 2 days from MI, GA, CA, TX or PA.



\* 2" spring-loaded swivel casters

ASSEMBLED					10" DEEP TOP STEP			20" DEEP TOP STEP		
MODEL NO.	STEPS	PLATFORM HEIGHT	OVERALL HEIGHT	BASE W x D	PRICE EACH		WT. (LBS.)	PRICE EACH		WT. (LBS.)
					1	2+		1	2+	
H-5071*	3	30"	60"	20 x 26"	\$292	\$283	43	\$390	\$383	58
H-5072*	4	40"	70"	20 x 31"	374	366	56	449	443	71
H-5073	5	50"	80"	20 x 40"	479	469	85	568	562	100
H-5074	6	60"	90"	24 x 46"	531	524	102	681	673	117
H-5075	7	70"	100"	24 x 53"	583	567	111	728	712	126



## TRAILER ACCESS

Secure, safe access to semitrailers.

- Rolls easily on 10" rubber wheels. • Slip-resistant rubber grip pads keep ladder in place.
- Gradual 50° incline for easy, forward-facing descent.
- 24" wide serrated steps and platform. • 800 lb. capacity.
- Drop ships in 2 days from MI, GA, CA, TX or PA.



ASSEMBLED						24" DEEP TOP STEP		
MODEL NO.	STEPS	PLATFORM HEIGHT	OVERALL HEIGHT	BASE W x D	PLATFORM W x D	PRICE EACH		WT. (LBS.)
						1	2+	
H-3013	5	50"	86"	32 x 63"	24 x 24"	\$820	\$802	118



## TILT AND ROLL

Rolls like a hand truck for easy mobility in stores and stockrooms.

- Sits firmly on four large rubber pads for excellent stability. • 59° incline.
- Easily tilts onto two 4" polypropylene wheels. • 24" wide expanded metal steps.
- 450 lb. capacity. • Drop ships in 2 days from MI, GA, CA, TX or PA.

SPECIFY COLOR:  Gray  Yellow

ASSEMBLED						10" DEEP TOP STEP		
MODEL NO.	STEPS	PLATFORM HEIGHT	OVERALL HEIGHT	BASE W x D	PLATFORM W x D	PRICE EACH		WT. (LBS.)
						1	2+	
H-5084	3	30"	60"	28 x 30"	24 x 10"	\$321	\$313	50
H-5085	4	40"	70"	28 x 37"		405	395	61
H-5086	5	50"	80"	28 x 43"		508	498	75

## STATIONARY WORK PLATFORMS

SPECIFY COLOR:  Gray  Yellow

MODEL NO.	STEPS	PLATFORM W x D	PLATFORM HEIGHT	LOAD CAPACITY	PRICE EACH		WT. (LBS.)
					1	2+	
H-5090	1	24 x 24"	7 - 9"	800 lbs.	\$283	\$275	26
H-5091			10 - 15"		298	289	30
H-5092	36 x 24"	7 - 9"	373		360	38	
H-5093		10 - 15"	389		375	42	

SHIPS ASSEMBLED VIA UPS

Provides excellent stability while working on taller machines.

- Serrated metal tread provides slip resistance.
- Adjustable rubber feet for uneven surfaces.





# FORKLIFT AERIAL PLATFORMS



Change lights, restock, repair up high. Attaches to your forklift.

- 1,000 lb. capacity.
- 43" high guardrails. Outward swing gate.
- Heavy-duty steel diamond plate slip-resistant deck with 4" kickplate.
- Mesh backguard screen protects operator.

Cal/OSHA regulations require additional back riser, see uline.com

MODEL NO.	PLATFORM W x D	OVERALL HEIGHT	FORKLIFT POCKETS	WT. (LBS.)	PRICE EACH
■H-2771	36 x 48"	47"	2½ x 8"	186	\$1,050
■H-2772	48 x 40"			240	1,125
H-2776	4" Polyolefin Swivel Casters, Set of 4		7	70	

■ SHIPS ASSEMBLED VIA MOTOR FREIGHT

# STEP STOOLS

Sturdy and safe. Helps you reach harder-to-get places.

- Nonslip rubber feet. Hand holes for easy lifting.
- 18 x 9" self-draining nonslip steps. 17 x 11½" top step.
- Durable polyethylene.
- Storage area in 2 and 3-step models.



MODEL NO.	STEPS	TOP STEP HEIGHT	LOAD CAPACITY	BASE W x D	WT. (LBS.)	PRICE EACH	
						1	2+
H-2791	1	12"	500 lbs.	20 x 14"	10	\$75	\$70
H-2792	2	20"		21 x 25"	17	140	130
■H-2793	3	30"		21 x 34"	26	220	210

■ SHIPS VIA MOTOR FREIGHT

# FOLDING STEP LADDERS

## WAREHOUSE



Heavy-duty folding ladder for stockrooms, warehouses and factories.

- Tilt and roll. Two 4" wheels for portability.
- Closes to 10" thick with easy-to-use cable release system.
- 16" wide perforated metal steps. 10" deep top step.
- Heavy-gauge steel for durability.

## OFFICE

Convenient ladder to reach supplies, replace light bulbs and hang artwork.

- Tilt and roll. Two 2" wheels for transport.
- Collapsible safety handrail. Folds to a slim 5" profile.
- 14" wide slip-resistant steps. 9" deep steps.
- Lightweight, aluminum frame.



### STEP AND STORE

SPECIFY COLOR:  Gray  Yellow

MODEL NO.	STEPS	TOP STEP HEIGHT	LOAD CAPACITY	BASE W x D	WT. (LBS.)	PRICE EACH	
						1	2+
H-5604	2	20"	350 lbs.	21 x 22"	33	\$374	\$360
H-5605	3	30"		21 x 29"	40	431	410
■H-5606	4	40"		21 x 36"	48	480	459

■ SHIPS VIA MOTOR FREIGHT

### LITTLE GIANT®

MODEL NO.	STEPS	TOP STEP HEIGHT	LOAD CAPACITY	BASE W x D	WT. (LBS.)	PRICE EACH	
						1	2+
H-7891	2	18"	300 lbs.	21 x 23"	15	\$180	\$170
H-7892	3	26"		22 x 34"	21	215	205
H-7893	4	35"		22 x 46"	27	265	255

SHIPS ASSEMBLED VIA UPS

# REAR-EXIT WORK PLATFORMS

Safely walk onto elevated docks and access large machinery.

- Safety chains allow user to enter and exit platform.
- 36" deep platform provides extra space to maneuver.
- 24" wide serrated metal steps. • 42" high handrails.
- Four 4" diameter casters: 2 swivel, 2 rigid. • 50° incline.

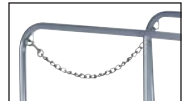

800 LB. CAPACITY

### ASSEMBLED

Additional sizes, see uline.com

MODEL NO.	STEPS	PLATFORM W x D	PLATFORM HEIGHT	OVERALL HEIGHT	BASE W x D	WT. (LBS.)	PRICE EACH	
							1	2+
H-7920	5	24 x 36"	50"	92"	28 x 70"	157	\$985	\$971
H-7921	6		60"	102"	28 x 79"	173	1,212	1,198
H-7922	7		70"	112"	28 x 87"	190	1,365	1,350
H-7923	8		80"	122"	28 x 95"	225	1,455	1,438

Drop ships in 2 days from MI, GA, CA, TX or PA

# ROLLING STEP LADDERS



Push this ultra-sturdy ladder around with just a foot or hand!

- Cup shoes grip the floor for stability. Spring-loaded casters retract when weight is applied.
- Recommended for offices, groceries, retailers and auto parts stores.
- Welded steel construction will last a lifetime. Powder-coated.



GRIPPY CUP SHOES

SPECIFY COLOR:  Gray  Yellow

MODEL NO.	STEPS	TOP STEP HEIGHT	LOAD CAPACITY	BASE W x D	WT. (LBS.)	PRICE EACH	
						1	2+
H-968	2	18"	450 lbs.	22 x 20"	28	\$476	\$452
■ H-969	3	27"		24 x 27"	37	567	540
■ H-7903	4	36"		25 x 34"	59	786	759
■ H-7904*	5	45"		26 x 40"	77	921	887

- Large 16 x 8" steps with nonslip treads.

H-7903 and H-7904 – Double handrails for safe climbing.

\*Available in Gray only

■ SHIPS ASSEMBLED VIA MOTOR FREIGHT

# ALUMINUM STEP STANDS



Serrated steps for a better grip.

- Recommended for oily repair and machine shops.
- Welded aluminum construction.
- Corrosion resistant for humid and damp environments.
- Slip-resistant rubber feet.

INDOOR/OUTDOOR

OSHA and ANSI Compliant

MODEL NO.	STEPS	TOP STEP HEIGHT	LOAD CAPACITY	BASE W x D	WT. (LBS.)	PRICE EACH	
						1	2+
H-9312	1	10"	500 lbs.	27 x 17"	10	\$198	\$185
H-7905	2	20"		27 x 22"	14	301	287
H-7906*	3	30"		28 x 34"	25	485	466

\* EASY ASSEMBLY. SHIPS VIA UPS.

# KING KOMBO™ LADDERS

Triple threat. This does it all for painters, electricians and contractors.

- Easily rotate between step, extension and leaning ladder.
- Wall pad leans flat or grips corners.
- Non-conductive fiberglass rails.



TYPE 1AA LITTLE GIANT

MODEL NO.	HEIGHT	LOAD CAPACITY	BASE W x D	WT. (LBS.)	PRICE EACH	
					1	2+
H-9944	6'	375 lbs.	25 x 44"	22	\$270	\$255
H-9945	8'		28 x 59"	31	335	320

SHIPS VIA MOTOR FREIGHT

# FIBERGLASS STEP LADDERS

## HEAVY DUTY

Working off the ground requires high-quality industrial ladders.

- Extra-wide base provides stability. Aluminum Holster-Top® platform.
- Reinforced edge bracing and heavy-duty steel supports.
- 375 lb. load capacity.



TYPE 1AA WERNER

MODEL NO.	HEIGHT	BASE W x D	WT. (LBS.)	PRICE EACH	
				1	2+
H-5623	6'	26 x 43"	24	\$185	\$175
H-5624	8'	30 x 56"	31	240	230
H-5625	10'	33 x 68"	41	330	315

SHIPS VIA MOTOR FREIGHT

## TWIN STEP

What the pros use on construction, roofing and remodeling jobs.

- Steps on both sides allow for dual access without repositioning ladder.
- Rock steady for one or two-man use.
- 300 lb. load capacity per side.



TYPE 1A WERNER

MODEL NO.	HEIGHT	BASE W x D	WT. (LBS.)	PRICE EACH	
				1	2+
H-8642	6'	24 x 51"	27	\$235	\$225
H-8643	8'	28 x 65"	37	315	300
H-8644	10'	31 x 79"	45	420	400

SHIPS VIA MOTOR FREIGHT

# ALUMINUM LADDERS

General-purpose ladders for use in your plant, your office and at home.

- Lightweight and easy to carry around.
- Nonslip treads help keep your feet stable as you work.
- Pinch-proof spreaders. • Folds to only 6" wide.



MODEL NO.	HEIGHT	LOAD CAPACITY	BASE W x D	WT. (LBS.)	PRICE EACH	
					1	2+
H-1559	2'	300 lbs.	17 x 19"	6	\$59	\$56
H-2795	4'		20 x 30"	11	105	100
■H-2796	6'		23 x 42"	16	145	135
■H-2797	8'		27 x 55"	23	195	185
■H-5619	10'		30 x 67"	31	255	240

■ SHIPS VIA MOTOR FREIGHT

TYPE 1A  
WERNER

# FIBERGLASS LADDERS

Working off the ground requires high-quality industrial ladders.

- Electricity safe. Fiberglass rails are non-conductive.
- Nonslip rubber feet. • Reinforced edge bracing.



TYPE 1A  
WERNER

## PLATFORM

Comfortable 14 x 15" work platform with 24" high safety rail.

- 300 lb. load capacity.

MODEL NO.	OVERALL HEIGHT	PLATFORM HEIGHT	BASE W x D	WT. (LBS.)	PRICE EACH	
					1	2+
H-7881	4'	2'	24 x 30"	17	\$170	\$160
H-4132	6'	4'	27 x 42"	24	200	190
H-4133	8'	6'	31 x 55"	32	255	240
H-4134	10'	8'	34 x 67"	45	355	335
H-4135	12'	10'	38 x 79"	55	425	395

SHIPS VIA MOTOR FREIGHT

## STEP

Holster-Top® platform holds tools and paint cans.

- 300 lb. load capacity.



TYPE 1A  
WERNER

## STEP

MODEL NO.	HEIGHT	BASE W x D	WT. (LBS.)	PRICE EACH	
				1	2+
H-3836	2'	17 x 20"	9	\$95	\$90
H-2160	4'	20 x 29"	16	125	120
■H-1194	6'	24 x 42"	23	160	150
■H-1195	8'	27 x 54"	25	\$185 any qty.	
■H-1800	10'	31 x 66"	39	295	280
■H-1445	12'	34 x 79"	48	370	355

■ SHIPS VIA MOTOR FREIGHT

## EXTENSION

Gravity spring locks secure ladder at heights up to 25'.

- 300 lb. load capacity.
- Spur plates for safety on soft ground.
- Height adjusts using heavy-duty rope and pulley.

## EXTENSION

MODEL NO.	HEIGHT	MAX. WORKING HEIGHT	WT. (LBS.)	PRICE EACH	
				1	2+
H-4137	20'	17'	45	\$330	\$305
H-4138	24'	21'	52	375	350
H-5621	28'	25'	60	455	425

SHIPS VIA MOTOR FREIGHT

## PODIUM

Extra-large 16 x 20" work platform with 36" high safety rail.

- 300 lb. load capacity.
- LOCKTOP™ safety rail secures tools from falling.
- Platform toe guard helps prevent missteps.

## PODIUM

MODEL NO.	OVERALL HEIGHT	PLATFORM HEIGHT	BASE W x D	WT. (LBS.)	PRICE EACH	
					1	2+
H-7015	7'	4'	27 x 43"	27	\$225	\$215
H-7016	9'	6'	31 x 56"	34	285	270
H-7017	11'	8'	35 x 68"	47	385	365

SHIPS VIA MOTOR FREIGHT



TYPE 1A  
WERNER



TYPE 1A  
WERNER



## RETRACTABLE CORD REELS

Never wind a cord again. Pull down for safe and easy access.

- Wall and ceiling mountable. Hardware included.
- Cord locks to desired length, retracts with slight tug.
- 3 grounded outlets with resettable circuit breaker.



**All Purpose** – Powder-coated steel housing.

**Heavy Duty** – Industrial grade polyethylene housing.

\* ETL/C-ETL Listed

UL/C-UL Listed

MODEL NO.	DESCRIPTION	CORD LENGTH	GAUGE/ CONDUCT.	125V RATING	WT. (LBS.)	PRICE EACH	
						1	4+
H-5642*	All Purpose	25'	16/3	10A	7	\$81	\$78
H-5643		30'	14/3	13A	10	115	110
H-5644	Heavy Duty	40'	12/3	15A	15	210	200
H-6412*		65'	12/3	15A	22	255	245



## INDUSTRIAL CORD REELS

Not for your average garage. This is for the big boys.

- Tough, welded steel frame. Powder-coat finish.
- For assembly plants, machine shops and welding tools.
- Permanently mount to wall, ceiling or your workbench.
- Cord locks to any length.
- Self-retracting.

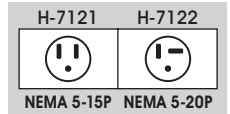

Made in the USA

UL Listed. CSA Certified.

MODEL NO.	DESCRIPTION	CORD LENGTH	GAUGE/ CONDUCT.	125V RATING	WT. (LBS.)	PRICE EACH	
						1	2+
H-7121	Single Outlet	45'	12/3	15A	24	\$560	\$540
H-7122						590	570

Hardware not included



## TABLETOP POWER STRIPS



Power for all your tools right where you need it – Mount to wall or bench top.

- Master on/off switch with 12 to 18 outlets.
- 15 amp circuit breaker.
- Safety covers protect unused outlets.

UL/C-UL Listed

MODEL NO.	NO. OF OUTLETS	STRIP LENGTH	CORD LENGTH	COLOR	GAUGE/ CONDUCT.	PRICE EACH	
						1	3+
H-4128	12	49"	6'	Black	14/3	\$65	\$62
H-7835	18	60"	15'			91	86

## VORNADO® SHOP FAN



Use in your garage, workshop or job site.

- Cushioned grab-and-go handle.
- Moves air up to 100 ft.
- 9' power cord. 120 Volts.
- 3 speeds. 3 blades. Head tilts 360°.

ETL/C-ETL Listed. OSHA Compliant.

MODEL NO.	DIMENSIONS W x H x D	FAN SIZE	AMPS	MAX. CFM	WT. (LBS.)	PRICE EACH	
						1	3+
H-3780	16 x 19 x 15"	10"	0.8	685	14	\$170	\$160

## VORNADO® ROOM HEATER

Warm up your guard shack, workshop or assembly area.

- Durable metal construction stays cool to the touch.
- 2 heat settings with adjustable thermostat.
- Auto shutoff if overheats.
- Built-in handle. 6' power cord. 120 Volts.



ETL/C-ETL Listed

MODEL NO.	DIMENSIONS W x H x D	THERMOSTAT RANGE	BTU	AMPS	WATTS	WT. (LBS.)	PRICE EACH	
							1	3+
H-9923	9 x 12 x 10"	60-90°F	2,559/ 5,118	6.25/ 12.5	750/ 1,500	10	\$140	\$130

# EXTENSION CORDS

INDOOR/OUTDOOR

**All Purpose** – For standard maintenance jobs.

**Low Temp.** – Stays flexible in extreme cold down to -58°F.

- Oil, chemical and UV resistant.

**Heavy Duty** – Use in harsh environments.

- Power indicator light.

**Triple Outlet** – Power multiple tools with one cord.

- Three grounded outlets. For harsh environments.

**Cord Reels** – Portable power wherever you need it.

- Six outlets, 50-ft. cord. Lighted on/off switch.
- Heavy Duty – Professional grade. 1875 maximum watt rated.

ALL PURPOSE  
S-13797



LOW TEMP.  
S-19000



HEAVY DUTY  
S-19002



S-19879

## SINGLE OUTLET

UL/C-UL Listed

MODEL NO.	DESCRIPTION	LENGTH (FEET)	GAUGE/ CONDUCT.	125V RATING	PRICE EACH		
					1	2	5+
S-19877	All Purpose	15	16/3	13A	N/A	\$13	\$12
S-16889		25	14/3	15A	N/A	20	19
S-13797		50	14/3	15A	\$37	36	35
S-13798		100	14/3	13A	69	66	64
S-18999	Low Temp.	25	14/3	15A	33	32	31
S-19000		50			52	50	48
S-16890	Heavy Duty	25	12/3	15A	33	32	31
S-13799		50			56	53	51
S-13800		100			101	96	92

## TRIPLE OUTLET

UL/C-UL Listed

MODEL NO.	DESCRIPTION	LENGTH (FEET)	GAUGE/ CONDUCT.	125V RATING	PRICE EACH		
					1	2	5+
S-19001	Heavy Duty	2	12/3	15A	N/A	\$13	\$12
S-19002		25			\$43	42	39
S-19878		50			74	70	66
S-20605		100			128	122	116

## CORD REELS – 50 FT.

UL/C-UL Listed

MODEL NO.	DESCRIPTION	DIMENSIONS L x W x H	GAUGE/ CONDUCT.	125V RATING	PRICE EACH	
					1	4+
S-19879	All Purpose	11½ x 7½ x 15"	14/3	15A	\$100	\$95
S-19880	Heavy Duty		12/3		135	125

# POWER STRIPS

Instantly add outlets in your office, warehouse or workshop.

- Circuit breaker stops electricity flow. 15 amp.
- Durable metal casing. Lighted on/off switch.

UL/C-UL Listed

MODEL NO.	NO. OF OUTLETS	STRIP LENGTH	CORD LENGTH	COLOR	GAUGE/ CONDUCTOR	PRICE EACH	
						1	3+
H-3583	6	11½"	5'	Gray	14/3	\$27	\$25
H-4125		14½"	15'	Yellow		42	39
H-4916		10"	6'	Yellow		39	36

"Chub Boat" H-4916 – Double-wide 10 x 6" strip fits three extra large adapters.



"CHUB BOAT"

# SURGE PROTECTORS

Protect computers and electronic equipment from power surges and spikes.

- Automatic shutdown protection.
- Accepts 3-prong NEMA 5-15 plugs.
- Master on/off switch. H-2787 includes LED indicator.

UL/C-UL Listed

MODEL NO.	NO. OF OUTLETS	STRIP LENGTH	CORD LENGTH	JOULES	GAUGE/ CONDUCTOR	PRICE EACH	
						1	3+
H-2786	6	9¾"	4'	735	14/3	\$16	\$15
H-2787	7	11½"	15'	800		29	27



Safety covers protect unused outlets from dust.



# CORD PROTECTORS

Protection from pedestrians, carts and lightweight traffic.

SPECIFY COLOR: Black or Yellow

MODEL NO.	MAX. CORD DIAMETER	LENGTH	OUTSIDE DIM. W x H	WT. (LBS.)	PRICE EACH	
					1	5+
H-4126	5/16"	10'	2¼ x 1½"	4	\$28	\$27
H-4127	1/2"	5'	3 x 3/4"	3	22	21
H-4917	3/4"	5'	3½ x 1"	4	26	25

- Tapered profile reduces tripping hazards.
- Flexible, durable PVC.
- Pre-slit on bottom for inserting cords. Cut to desired length.





## VERSA-KOOL® DRUM FANS

SCHAEFER

Recommended for gymnasiums and public areas when power and appearance matter.

- Provides up to 10 years of reliable performance. Outlasts them all.
- Durable direct-drive motor. • 3 blades. • Tough polyethylene housing.

H-9319 – 6" solid rubber wheels. 2 speeds.

H-7125 – 8" solid rubber wheels. 1 speed.



### 2 YEAR WARRANTY

ETL/C-ETL Listed

MODEL NO.	FAN SIZE	DIMENSIONS W x H x D	HP	CFM	VOLTS	WT. (LBS.)	PRICE EACH	
							1	3+
H-9319	24"	29 x 27 x 16"	1/2	4,580-5,640	115	55	\$710	\$680
H-7125	36"	41 x 40 x 20"		850		820		

SHIPS ASSEMBLED VIA MOTOR FREIGHT

## WORKSTATION FANS



Keep your personal workspace cool.

- Use at packing stations or other warehouse locations.
- 3 blades. 3 speeds. 120 Volts.
- Head tilts 360° to direct airflow.

ETL/C-ETL Listed. OSHA Compliant.

MODEL NO.	FAN SIZE	DIMENSIONS W x H x D	HP	CFM	WT. (LBS.)	PRICE EACH	
						1	3+
H-4091	12"	15 x 15 x 8"	1/12	1,120-1,420-1,650	13	\$135	\$130
H-4092	18"	22 x 22 x 8"	1/8	3,200-4,200-4,600	20	160	155

SHIPS ASSEMBLED VIA UPS

## INDUSTRIAL CEILING FANS

Large 45" blades move prodigious amounts of air in warehouses, barns and gymnasiums.

- 6 contoured aluminum blades.
- Quiet, maintenance-free motor.
- 5 speeds. 120 Volts.
- Hardwiring required.
- Reversible flow. Blows down or up.

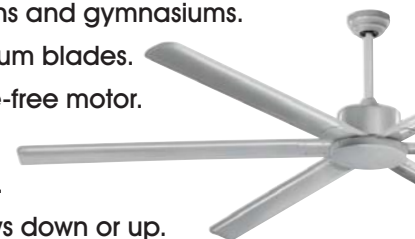

CANARM®

CSA Listed

MODEL NO.	FAN SIZE	BLADE LENGTH	AMPS	CFM	DOWN ROD	WT. (LBS.)	PRICE EACH	
							1	3+
H-9330	96"	45"	0.9	10,300-16,750	12"	40	\$725	\$700
H-9584	120"	55"		11,100-20,700		50	780	755

Includes remote control

SHIPS UNASSEMBLED VIA UPS



## INDUSTRIAL WALL MOUNT FANS

Free up floor space.

- 3 blades. 120 Volts.
- Swing arm lets you direct airflow.

**Stationary** – Focused airflow. Adjustable fan head angle.

**Oscillating** – Swings in wide 90° arc.

### STATIONARY

2 SPEEDS

MODEL NO.	FAN SIZE	DIMENSIONS W x H x D	HP	CFM	WT. (LBS.)	PRICE EACH	
						1	3+
H-1421	24"	24 x 24 x 21"	1/3	5,200-7,000	43	\$360	\$350
H-1422	30"	30 x 30 x 21"		6,200-8,200	53	370	360

### OSCILLATING

3 SPEEDS

MODEL NO.	FAN SIZE	DIMENSIONS W x H x D	HP	CFM	WT. (LBS.)	PRICE EACH	
						1	3+
H-1456	24"	24 x 24 x 21"	1/4	5,000-6,800	49	\$440	\$430
H-1457	30"	30 x 30 x 21"		6,000-7,900	52	450	440

SHIPS UNASSEMBLED VIA MOTOR FREIGHT



## HEAVY-DUTY WALL MOUNT FANS

2 YEAR WARRANTY

Powerful 1/2 HP motor airs out stuffy workstations and fabrication shops.

- 3 blades. 2 speeds. 120 Volts. • Adjustable bracket lets you direct airflow.

**Stationary** – Large fans generate a broader breeze.

**Oscillating** – Swings in a wide 90° arc or locks in a fixed position.

### STATIONARY

CSA Listed

MODEL NO.	FAN SIZE	DIMENSIONS W x H x D	HP	CFM	WT. (LBS.)	PRICE EACH	
						1	3+
H-7096	30"	33 x 33 x 31"	1/2	6,700-9,250	56	\$440	\$420
H-7097	36"	41 x 41 x 31"		8,700-12,100	68	550	530

### OSCILLATING

MODEL NO.	FAN SIZE	DIMENSIONS W x H x D	HP	CFM	WT. (LBS.)	PRICE EACH
H-7098	30"	33 x 33 x 31"	1/2	8,500-9,600	65	\$585

SHIPS UNASSEMBLED VIA MOTOR FREIGHT



# INDUSTRIAL FANS

ETL/C-ETL Listed. OSHA Compliant.

## PEDESTAL FANS

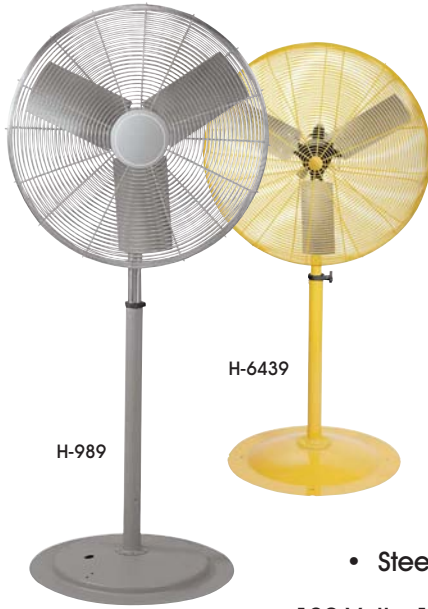

Cool your warehouse with these industrial, long-lasting fans.

- 3 aluminum blades.
- Adjustable height 65-84".
- Fan head (2-speed) comes fully assembled.
- Maintenance free. Totally enclosed motor keeps out dust and moisture.

- Steel wire guards for safety.
- 120 Volts. 12' long power cord.

- Oscillating Fans – Sweep in a wide 90° arc or lock in a fixed position.

**Heavy Duty** – Powerful 1/2 HP motor. Adjustable height 63-77". 120 Volts. 10' long power cord. Hi-vis yellow.

**STATIONARY** SHIPS UNASSEMBLED VIA MOTOR FREIGHT

MODEL NO.	FAN SIZE	HP	CFM	WT. (LBS.)	PRICE EACH	
					1	3+
H-1406	24"	1/3	5,200-7,000	72	\$445	\$435
H-989	30"		6,200-8,200	79	470	455

**OSCILLATING** \* 3 SPEEDS

MODEL NO.	FAN SIZE	HP	CFM	WT. (LBS.)	PRICE EACH	
H-1407*	24"	1/4	5,000-6,800	78	\$530	\$510
H-1408*	30"		6,000-7,900	84	555	530

**HEAVY-DUTY STATIONARY** 2 YEAR WARRANTY

MODEL NO.	FAN SIZE	HP	CFM	WT. (LBS.)	PRICE EACH	
					1	3+
H-6438	30"	1/2	6,700-9,250	89	\$545	\$525
H-6439	36"		8,700-12,100	110	675	650

CSA Listed

**HEAVY-DUTY OSCILLATING** 2 YEAR WARRANTY

MODEL NO.	FAN SIZE	HP	CFM	WT. (LBS.)	PRICE EACH	
H-6440	30"	1/2	8,500-9,600	94	\$685	\$660

CSA Listed

## FLOOR FANS

Breezy comfort keeps workers cool.

- 3 blades.
- 3 speeds.
- Head tilts 360°.
- 120 Volts.



SHIPS ASSEMBLED VIA UPS

MODEL NO.	FAN SIZE	DIMENSIONS W x H x D	HP	CFM	WT. (LBS.)	PRICE EACH	
						1	3+
H-4791	12"	15 x 15 x 9"	1/12	1,120-1,420-1,650	13	\$140	\$135
H-1423	18"	22 x 22 x 9"	1/8	3,200-4,200-4,600	20	160	155
H-1573	24"	28 x 28 x 13"		3,600-5,200-5,850	23	255	245

## DRUM FANS

### STANDARD

Heavy-duty industrial fans ventilate large warehouse areas.

- Durable, totally enclosed direct-drive motor. Maintenance free.
- 3 blades.
- 2 speeds.
- 8" wheels.
- 120 Volts.



\* 10" WHEELS, 1 SPEED

EASY ASSEMBLY. SHIPS VIA MOTOR FREIGHT.

MODEL NO.	FAN SIZE	DIMENSIONS W x H x D	HP	CFM	WT. (LBS.)	PRICE EACH	
						1	3+
H-1574	30"	31 x 32 x 19"	1/4	6,000-7,800	65	\$585	\$565
H-1196	36"	37 x 38 x 19"	1/3	9,000-12,500	82	760	740
H-1575*	42"	43 x 44 x 19"	1/2	15,600	102	840	810

### POWER PLUS

High-capacity fans blast hot, stagnant air from large areas.

- Belt-drive motor increases longevity.
- 4 blades.
- 2 speeds.
- 9" wheels.
- 120 Volts.



SHIPS ASSEMBLED VIA MOTOR FREIGHT

MODEL NO.	FAN SIZE	DIMENSIONS W x H x D	HP	CFM	WT. (LBS.)	PRICE EACH	
						1	3+
H-9345	36"	37 x 40 x 20"	3/4	12,800-15,000	85	\$640	\$620
H-9346	42"	44 x 46 x 20"	3/4	16,900-20,500	107	710	680
H-9347	48"	50 x 51 x 20"	1	21,800-25,700	120	825	795

UL/C-UL Listed

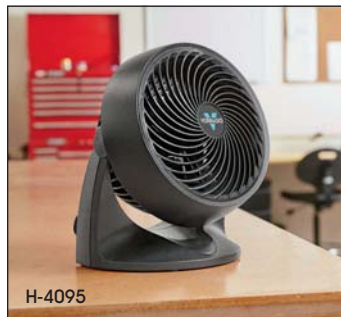

H-4095

## VORNADO® ROOM FANS

Compact fans provide a quiet breeze for a comfortable work environment.

- Tilting head with 3 blades.
- 3 speeds.
- 6' power cord. 120 Volts.
- Convenient size for desks and workbenches.

**H-8553** – Place on floor in offices and workshops.

MODEL NO.	FAN SIZE	DIMENSIONS W x H x D	MAX. AIR MOVEMENT	MAX. CFM	WT. (LBS.)	PRICE EACH	
						1	3+
H-8552*	5"	8 x 9 x 6"	25 ft.	121	2	\$39	\$37
H-4095	7"	10 x 12 x 7"	70 ft.	293	5	50	47
H-8553	11"	15 x 17 x 11"	100 ft.	643	8	110	105

SHIPS ASSEMBLED VIA UPS

ETL/C-ETL Listed

# WINDOW AIR CONDITIONERS

FRIGIDAIRE®



H-9286

Cool down warehouse offices or construction trailers.

- Exhaust drains out the back. Window mounting kit included.
- Digital display with 3 fan speeds.
- Removable, washable filters. Remote control.
- 24-hour timer, sleep mode and adjustable thermostat 62° to 86°F.

115 VOLTS

CSA Listed

MODEL NO.	DIMENSIONS W x H x D	COOLING CAPACITY	BTU	AMPS	WATTS	WT. (LBS.)	PRICE EACH	
							1	2+
H-9286	19 x 13 x 16"	250 sq. ft.	6,000	4.7	500	53	\$340	\$330
H-9288	19 x 15 x 22"	550 sq. ft.	12,000	9.7	1,000	82	530	510

SHIPS VIA MOTOR FREIGHT

# SADDLE WINDOW AIR CONDITIONERS

SOLEUS AIR®



NEW DESIGN

H-9299

Let the sunshine in! Low profile unit straddles the window in schools and cabins.

- 30% quieter than standard window units. Window mounting kit included.
- Exhaust drains out back.
- Removable, washable filters.
- Digital display and 3 fan speeds. Remote control.
- 24-hour timer, sleep mode and adjustable thermostat 62° to 86°F.

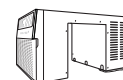

Fits window sills up to 11" deep

115 VOLTS

ETL/C-ETL Listed

MODEL NO.	DIMENSIONS W x H x D	COOLING CAPACITY	BTU	AMPS	WATTS	WT. (LBS.)	PRICE EACH	
							1	2+
H-9299	19 x 15 x 28"	275 sq. ft.	6,000	4.5	495	68	\$665	\$645
H-9300	19 x 15 x 28"	375 sq. ft.	8,000	6.5	667	71	695	675

SHIPS VIA MOTOR FREIGHT

# PORTABLE AIR CONDITIONERS

FRIGIDAIRE®



H-5274

Cool down and dehumidify offices and small areas.

- Never empty a drain bucket again. Moisture vents through window hose.
- Extendable exhaust hose up to 55" with window mounting kit.
- Removable, washable filters. Remote control.
- 3 fan speeds.
- 24-hour timer, sleep mode and adjustable thermostat 60° to 90°F.

115 VOLTS

ETL/C-ETL Listed

MODEL NO.	DIMENSIONS W x H x D	COOLING CAPACITY	BTU	AMPS	WATTS	WT. (LBS.)	PRICE EACH	
							1	2+
H-5274	17 x 28 x 14"	450 sq. ft.	10,000	8.5	930	65	\$530	\$510
H-8649	17 x 28 x 14"	550 sq. ft.	12,000	12.0	1,100	75	615	595

SHIPS VIA MOTOR FREIGHT

# INDUSTRIAL AIR CONDITIONERS

KWIKOOL®



H-8772

Roll it in. Cool down your workspace, assembly area or repair shop.

- Lowers air temperature by up to 20°F. Adjustable thermostat.
- Two flexible air chutes blow cold air up to 5 feet away.
- 3.5-gallon condensate tank with overflow protection.
- Automatic restart after a power failure. 8' power cord.
- 4" rubber casters: 2 swivel with brake, 2 rigid.



Optional Ceiling Duct Kit available, see uline.com

115 VOLTS

ETL/C-ETL Listed

MODEL NO.	DIMENSIONS W x H x D	COOLING CAPACITY	BTU	AMPS	WATTS	WT. (LBS.)	PRICE EACH
H-8771	17 x 38 x 26"	400 sq. ft.	13,700	11.5	1,190	157	\$3,515
H-8772*		600 sq. ft.	16,800	14.5	1,500		3,975

\* Requires a 20A outlet

SHIPS VIA MOTOR FREIGHT

# JET-STREAM FANS

INDOOR/OUTDOOR

Blast air up to 100' away. Highly recommended to cool down aisles and loading docks.

- 3 aluminum blades. 1 speed. 115 Volts. • IP55 rated for outdoor use.
- Durable polypropylene housing. Tilting head directs airflow.

Wall Bracket – Mount to wall to keep valuable floor space open.

1 YEAR WARRANTY

CSA Listed

MODEL NO.	DIMENSIONS W x H x D	FAN SIZE	AIR FLOW DISTANCE	HP	CFM	WT. (LBS.)	PRICE EACH	
							1	3+
H-9924	24 x 24 x 16"	18"	80'	1/2	3,800	43	\$725	\$700
H-9925	29 x 29 x 16"	22"	100'		5,570	49	865	840
H-9926	Optional Wall Bracket		4 x 22 x 22" (W x H x D)			12	125	120
H-9927	Optional Mobile Pedestal		33 x 31 x 28" (W x H x D)			34	215	205

SHIPS VIA MOTOR FREIGHT



Shown with optional Mobile Pedestal

Mobile Pedestal – 31" high. Tilt and roll on two 5" casters.

# POWER BREEZER® MISTING FAN

INDOOR/OUTDOOR

Innovative technology provides a cool, fine mist that won't get you or your equipment wet.

- Recommended for loading docks, sporting events and large venues.
- 85-gallon water tank cools for up to 5 days without a refill.
- Reduce temperature by up to 27°F. • Use as fan only or with mist. Oscillating.
- No filters or pads to replace. • 10" locking rear wheels. • Variable speeds. 120 Volts.

2 YEAR WARRANTY

ETL/C-ETL Listed

MODEL NO.	DIMENSIONS W x H x D	FAN SIZE	COOLING CAPACITY	HP	CFM	AMPS	WATER CAP.	WT. (LBS.)	PRICE EACH
H-8656	30 x 74 x 54"	23"	3,000 sq. ft.	1	14,000	9.0	85 gal.	220	\$5,995

SHIPS ASSEMBLED VIA MOTOR FREIGHT



# COMPACT EVAPORATIVE COOLER

INDOOR/OUTDOOR

Compact and powerful. Designed for cooling small repair shops and garages.

- Built-in water tank for portable cooling or connect to a garden hose for all-day use.
- Adjustable louvers direct airflow. • Variable speeds. 115 Volts.
- Heavy-duty casters: 2 swivel, 2 locking. • Low water level safety shutoff.

1 YEAR WARRANTY

ETL/C-ETL Listed

MODEL NO.	DIMENSIONS W x H x D	COOLING CAPACITY	HP	CFM	AMPS	WATER CAP.	WT. (LBS.)	PRICE EACH
H-8657	29 x 42 x 27"	700 sq. ft.	1/4	2,400	3.4	20 gal.	92	\$1,270

SHIPS ASSEMBLED VIA MOTOR FREIGHT



# EVAPORATIVE COOLERS

INDOOR/OUTDOOR

Portable, temporary "swamp" coolers lower air temperature.

- Recommended for stage events, hospitality tents and auto repair shops.
- Built-in water tank for portable cooling or connect to a garden hose for all-day use.
- Durable, leakproof polyethylene housing. • Variable speeds. 115 Volts.
- Heavy-duty casters: 2 swivel, 2 locking. • Low water level safety shutoff.

1 YEAR WARRANTY

ETL/C-ETL Listed

MODEL NO.	DIMENSIONS W x H x D	FAN SIZE	COOLING CAPACITY	HP	CFM	AMPS	WATER CAP.	WT. (LBS.)	PRICE EACH
H-9928	52 x 70 x 30"	24"	2,125 sq. ft.	1/2	8,500	6.6	55 gal.	191	\$3,215
H-7127	64 x 78 x 30"	36"	3,125 sq. ft.	3/4	12,500	9.3	60 gal.	267	3,750
H-7128*	78 x 91 x 36"	48"	5,625 sq. ft.	1 1/2	22,500	15.2	65 gal.	375	5,025

\* Requires a 20A outlet

SHIPS ASSEMBLED VIA MOTOR FREIGHT



H-7127

Replacement Pads and Covers available, see uline.com





## SMALL SPACE ELECTRIC HEATER

Warm small workspaces with localized heat. Safely use indoors.

- Temperature control thermostat. • Auto shutoff if overheats.
- Adjustable tilt control. • 6' power cord. Plugs into standard 120V outlet.
- Comfort grip handle. Non-marring, cushioned feet.

120 VOLTS

ETL/C-ETL Listed

MODEL NO.	DESCRIPTION	DIMENSIONS W x D x H	THERMOSTAT RANGE	BTU	AMPS	WATTS	WT. (LBS.)	PRICE EACH	
								1	3+
H-6099	Portable	12 x 9 x 13"	45-85°F	5,100	12.5	1,500	12	\$125	\$120



## PORTABLE ELECTRIC HEATERS

Take the chill out of offices or small work areas.

**Milkhouse** – 3 settings: Fan only, 1,300 watts and 1,500 watts.

**Ceramic** – Lightweight. Uses less power. 3 settings: Fan only, 900 watts and 1,500 watts.

**Ceramic Tower** – Programmable thermostat with timer. Oscillating. 2 settings: 900 watts and 1,500 watts.



CERAMIC TOWER

120 VOLTS

ETL/C-ETL Listed

MODEL NO.	DESCRIPTION	DIMENSIONS W x D x H	THERMOSTAT RANGE	BTU	AMPS	WATTS	WT. (LBS.)	PRICE EACH	
								1	3+
H-2308	Milkhouse	10 x 9 x 16"	50-90°F	4,437/ 5,120	10.8/ 12.5	1,300/ 1,500	9	\$79	\$75
H-3764	Ceramic	9 x 7 x 12"	60-90°F	3,070/ 5,118	7.0/ 12.5	900/ 1,500	5	54	50
H-3765	Ceramic Tower	7 x 9 x 23"					9	88	81

- Built-in temperature control thermostat. 6' power cord.
- Safe. Switches off if overheats.



## INDUSTRIAL STRING LIGHTS

Illuminate dark construction sites and after-hours city projects.

- Impact-resistant plastic cages protect bulbs. • Sockets spaced every 10 feet.
- Reinforced eyelets for secure overhead mounting. • 50' – Link up to 2 strings.

125 VOLTS

UL/C-UL Listed

MODEL NO.	DESCRIPTION	CORD LENGTH	NO. OF SOCKETS	GAUGE/ CONDUCTOR	AMPS	MAX. WATTS PER BULB	WT. (LBS.)	PRICE EACH	
								1	4+
H-9317	String Lights	50'	5	12/3	15	150	9	\$120	\$115
H-9318		100'	10				18	225	215

Use with incandescent or LED bulbs, sold separately



FILTER IS 100% NON-WOVEN SYNTHETIC MATERIAL

## PLEATED AIR FILTERS

Trap dust and particles in furnaces, air handlers and HVAC systems.

- Pleated design for higher dust and particle holding capacity.
- Moisture-resistant paperboard frame with diagonal supports.

**MERV 8** – General purpose for homes, offices and hotels.

**MERV 13** – Ultra-efficiency for labs, hospitals and data centers.

MERV 8

MERV 13

SOLD IN CASE QUANTITIES

NOMINAL SIZE W x H x D	QTY./ CASE	MODEL NO.	PRICE PER FILTER			MODEL NO.	PRICE PER FILTER		
			12	36	60+		12	36	60+
16 x 25 x 1" 20 x 20 x 1"	12	S-22966	\$6.40	\$6.10	\$5.85	S-24678	\$14.00	\$13.50	\$13.00
		S-22967	6.40	6.10	5.85	S-24152	13.50	13.00	12.50
16 x 20 x 2"	12	S-22959	6.45	6.20	5.90	S-24153	19.25	18.75	18.25
16 x 25 x 2"		S-22960	7.40	7.05	6.80	S-24154	22.00	21.50	21.00
20 x 20 x 2"		S-22961	7.05	6.80	6.50	S-24155	22.00	21.50	21.00
20 x 25 x 2"		S-22963	8.10	7.80	7.50	S-24156	25.75	25.00	24.25
24 x 24 x 2"		S-22964	8.90	8.60	8.30	S-24157	27.50	27.00	26.50

UL/C-UL Listed

# FORCED AIR HEATERS

Portable heat for warehouses, construction sites and pavilions.

- Provides instant warmth. Variable heat settings.
- Safety shutoff system for a loss of power or flame.

**Propane** – High output, 120V fan encased in a durable steel housing. Includes 9' hose and propane regulator. Propane tank not included.

**Multi-Fuel** – Uses kerosene, diesel or fuel oil and a 120V system to produce large volumes of heated air. Digital temperature display and fuel gauge. 10" heavy-duty wheels included.



MULTI-FUEL  
H-6513

## PROPANE

MODEL NO.	BTU	DIMENSIONS L x W x H	MIN. TANK SIZE (LBS.)	HEATING AREA	FUEL RATE (LBS./HR.)	WT. (LBS.)	PRICE EACH	
							1	3+
H-6511	40,000 - 60,000	18 x 8 x 13"	20	1,500 sq. ft.	1.9-2.8	14	\$235	\$225
H-6512	120,000 - 150,000	25 x 9 x 15"	100	3,800 sq. ft.	5.5-6.9	29	340	330

CSA Certified

## MULTI-FUEL

MODEL NO.	BTU	DIMENSIONS L x W x H	TANK CAP. (GAL.)	HEATING AREA	FUEL RATE (GAL./HR.)	WT. (LBS.)	PRICE EACH	
							1	3+
H-6513	140,000	39 x 23 x 26"	10	3,500 sq. ft.	1.1	56	\$485	\$460
H-6514	190,000	43 x 24 x 26"	13	4,750 sq. ft.	1.4	64	550	525

CSA Certified



PROPANE  
H-6512

# AIR CURTAINS

Keep your controlled climate in. Keep pests and dust out.

- Powerful 2-speed fan creates an invisible wall of air. • 1/3 HP.
- Directional vane regulates airflow. • Keep fumes out. • For indoor use.



## 120 VOLTS

MODEL NO.	DIMENSIONS W x H x D	MAX. DOOR WIDTH	MAX. DOOR HEIGHT	CFM	WATTS	WT. (LBS.)	PRICE EACH	
							1	3+
H-5781	35 x 10 x 9"	36"	10'	942-1,177	300	33	\$385	\$375
H-5782	47 x 10 x 9"	48"	10'	1,295-1,648	350	43	445	435

UL/C-UL Listed



H-5781

# AIR PURIFIERS

Sleek and quiet. Improves air quality in your office or shop.

- Carbon and HEPA filters remove odors and 99.97% of airborne particles.
- Filter replacement indicators. • Continuously cycles air throughout room.

**H-8650** – 3 speeds. Compact size for smaller spaces.

**H-8651** – 4 speeds. Dust sensor automatically adjusts output.

VORNADO®

## 120 VOLTS

MODEL NO.	DIMENSIONS W x H x D	ROOM SIZE	CFM	AMPS	WATTS	WT. (LBS.)	PRICE EACH	
							1	2+
H-8650	13 x 18 x 11"	220 sq. ft.	85-125	0.8	96	10	\$145	\$140
H-8651	13 x 27 x 12"	335 sq. ft.	68-161	1.2	145	15	275	270

ETL/C-ETL Listed



H-8651

SHIPS VIA UPS

# DEHUMIDIFIERS

Quietly remove moisture and musty odors from small offices and utility rooms.

- Set relative humidity from 35 to 80%. • 3 fan speeds.
- "Full" bucket indicator and auto shutoff. • Washable filter.
- Connect to garden hose for continuous drainage.

SOLEUS AIR®

## 115 VOLTS

MODEL NO.	DIMENSIONS W x H x D	PINTS/DAY	BUCKET CAP. (PINTS)	AMPS	WATTS	NOISE (dB)	WT. (LBS.)	PRICE EACH	
								1	3+
H-8554	14 x 20 x 10"	35	8.5	3.3	370	34	\$265	\$255	
H-8555	15 x 24 x 11"	50	16.9	4.6	525	44	315	305	

ETL/C-ETL Listed



H-8555

# LIGHT DUTY GUARD RAILS



Protect personnel and light machinery from forklifts and pallet trucks.

- 11-gauge steel. Up to 5,000 lb. impact rating at 4 mph.
- Powder-coated OSHA yellow.

**Welded Posts** – 3" square, 1/8" thick steel. 1/2" thick steel base plate.

**Lift-out Rails** – For temporary access and easy installation.

## POSTS

MODEL NO.	DESCRIPTION	HEIGHT	MOUNTING PLATE DIM.	WT. (LBS.)	PRICE EACH	
					1	4+
H-6243	End	42"	8 x 8"	22	\$105	\$100
H-6244	In-Line			24	110	105
H-6245	Corner			24	110	105

SHIPS VIA UPS

## RAILS

Stand alone rail length is 3" shorter than listed

MODEL NO.	DESCRIPTION	HEIGHT	ASSEMBLED LENGTH	WT. (LBS.)	PRICE EACH	
					2	4+
H-7616	Lift-out	4"	3'	11	\$55	\$50
H-6239			4'	15	65	60
H-6240			6'	23	90	85
H-6241			8'	30	110	105
■H-6242			10'	38	125	120

■ SHIPS VIA MOTOR FREIGHT

SHIPS VIA UPS



FIXED  
H-2120

# MACHINE GUARDS

Prevent damage to valuable machinery from forklifts and pallet trucks.

- Solid steel construction. High-visibility yellow.
- Protect equipment inside and guide semitrailers into docks outside. Tubular steel handles heavy abuse.



CORNER  
H-6275

**Removable** – Mounting plates slide out of removable bases for temporary access to machinery. Padlockable.

**Corner Guards** – Fit snug to corners to protect walls and machinery.

MODEL NO.	DESC.	DIAM.	HT.	LENGTH	MOUNTING PLATE DIM.	WT. (LBS.)	FIXED		REMOVABLE	
							1	4+	1	4+
■H-4076	High Profile	4.5"	24"	48"	8 x 8"	56	\$195	\$185	\$240	\$230
■H-4077			36"			67	205	195	250	240
■H-2120			42"			79	215	205	260	250
■H-6275	Corner	4.5"	36"	24 x 24"	8 x 8"	69	310	295	355	340
■H-6276			42"			81	320	305	365	345
H-2121*	Concrete Installation Kit (4 Anchors per Kit)					3	23	21	23	21

\* Machine Guards require 8 Anchors

■ SHIPS VIA MOTOR FREIGHT

## LOW PROFILE

Prevent your warehouse vehicles from plowing into conveyors, assembly lines or expensive equipment.



FIXED



REMOVABLE

MODEL NO.	DESC.	DIAM.	HT.	LENGTH	MOUNTING PLATE DIM.	WT. (LBS.)	FIXED		REMOVABLE	
							1	4+	1	4+
H-7687	Low Profile	4.5"	9"	36"	8 x 8"	37	\$135	\$125	\$190	\$180
H-7688			48"	43		145	135	200	190	
H-2121*	Concrete Installation Kit (4 Anchors per Kit)					3	23	21	23	21

\* Machine Guards require 8 Anchors

SHIPS VIA UPS



H-7687



# GUARD RAILS

Protect your warehouse, office walkways, conveyors or electrical equipment. A man's choice.

- Tough, tough steel rails.
- Up to 12,000 lb. impact rating at 4 mph.
- Powder-coated OSHA yellow.
- Mounting hardware included.

**Bolt-on Rails** – Permanent installation.

**Lift-out Rails** – Removable for easy access. Drop-in post brackets included.



## 2-RIB RAILS

Prevents a 10,000 lb. forklift load from breaking through at 4 mph. 12-gauge steel.



## 3-RIB RAILS

Prevents a 12,000 lb. forklift load from breaking through at 4 mph. 11-gauge steel.



**BOLT-ON – 2-RIB** Stand alone rail length is 4" shorter than listed

MODEL NO.	HEIGHT	ASSEMBLED LENGTH	WT. (LBS.)	PRICE EACH	
				1	4+
H-7708*	12"	2'	16	\$90	\$85
H-7710*		3'	24	95	90
H-6252		4'	32	105	100
H-7712	12"	5'	40	120	115
H-6253		6'	48	140	130
H-7714		7'	56	165	160
H-6254	12"	8'	64	175	165
H-7716		9'	72	185	175
H-6255		10'	80	190	180

\* SHIPS VIA UPS

SHIPS VIA MOTOR FREIGHT

**BOLT-ON – 3-RIB** Stand alone rail length is 4" shorter than listed

MODEL NO.	HEIGHT	ASSEMBLED LENGTH	WT. (LBS.)	PRICE EACH	
				1	4+
H-7718*	15"	2'	17	\$100	\$95
H-7720*		3'	26	105	100
H-3711		4'	35	115	110
H-7722	15"	5'	44	140	130
H-3712		6'	53	155	150
H-7724		7'	62	180	175
H-3713	15"	8'	71	190	180
H-7726		9'	80	200	190
H-3714		10'	89	210	200

\* SHIPS VIA UPS

SHIPS VIA MOTOR FREIGHT

**LIFT-OUT – 2-RIB** Stand alone rail length is 4" shorter than listed

MODEL NO.	HEIGHT	ASSEMBLED LENGTH	WT. (LBS.)	PRICE EACH	
				1	4+
H-7709*	12"	2'	23	\$110	\$105
H-7711*		3'	31	115	110
H-6247		4'	39	125	120
H-7713	12"	5'	47	150	145
H-6248		6'	55	165	160
H-7715		7'	63	185	180
H-6249	12"	8'	71	195	185
H-7717		9'	79	205	195
H-6250		10'	87	210	200

\* SHIPS VIA UPS

SHIPS VIA MOTOR FREIGHT

**LIFT-OUT – 3-RIB** Stand alone rail length is 4" shorter than listed

MODEL NO.	HEIGHT	ASSEMBLED LENGTH	WT. (LBS.)	PRICE EACH	
				1	4+
H-7719*	15"	2'	24	\$120	\$115
H-7721*		3'	33	125	120
H-4899		4'	42	145	140
H-7723	15"	5'	51	165	160
H-4900		6'	60	180	175
H-7725		7'	69	200	195
H-4901	15"	8'	78	210	200
H-7727		9'	87	220	210
H-4902		10'	96	240	225

\* SHIPS VIA UPS

SHIPS VIA MOTOR FREIGHT

## POSTS

4" square, 1/4" thick steel posts support single, double or triple rails.

- Welded to 5/8" thick steel base plates.



## SELF-CLOSING GATES

Allow employees easy access to machinery.

- Left or right-hand opening.



MODEL NO.	DESCRIPTION	HT.	MOUNTING PLATE DIM.	WT. (LBS.)	PRICE EACH	
					1	4+
H-3715*	Single Rail Post	19"	10 x 10"	37	\$120	\$115
H-3716	Double Rail Post	43"		61	180	170
H-8215	Triple Rail Post	60"		75	215	205

\* SHIPS VIA UPS

SHIPS VIA MOTOR FREIGHT

MODEL NO.	DESCRIPTION	RIBS	GAUGE	ASSEMBLED LENGTH	WT. (LBS.)	PRICE EACH	
						1	2+
H-8216	Double Rail Gate	2	12	4'	85	\$335	\$310
H-6251		3	11			95	360

SHIPS VIA MOTOR FREIGHT

# SAFETY BOLLARDS



FIXED BOLLARDS WITH CHAIN

## STANDARD AND HEAVY DUTY

Protect equipment from damage caused by forklifts and pallet trucks.

- Sturdy steel posts have removable black caps. Fill with concrete for extra strength.

**Fixed** – Permanent installation.

**Removable** – Mounting plate slides out of removable base for temporary access to equipment. Padlockable.

**Chain** – Creates a chain link barricade between bollards. Hardware included.

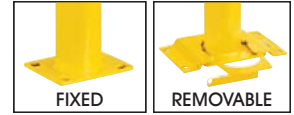

### STANDARD – 11 Gauge

MODEL NO.	DIAM.	HT.	MOUNTING PLATE DIM.	WT. (LBS.)	FIXED		REMOVABLE	
					1	4+	1	4+
H-5555		24"		18	\$90	\$85	\$110	\$105
H-2118		36"		22	95	90	115	110
H-2119	4.5"	42"	8 x 8"	24	110	105	130	125
H-5556		48"		26	120	115	140	135
H-6290		60"		34	140	135	160	150

SHIPS VIA UPS

### HEAVY DUTY – 9 Gauge

MODEL NO.	DIAM.	HT.	MOUNTING PLATE DIM.	WT. (LBS.)	FIXED		REMOVABLE	
					1	4+	1	4+
H-4970		36"		27	\$110	\$105	\$130	\$125
H-4971	5.5"	42"	8 x 8"	43	125	120	145	140
H-6291		48"		51	140	135	165	155
H-6292		60"		67	170	160	190	180
H-2121*	Concrete Installation Kit (4 Anchors/Kit)				23	21	23	21
H-6289	10' Steel Chain				18	17	18	17

SHIPS VIA UPS



## BOLLARD BASE COVERS

Cover up rusty bolts. Keep your facility looking fresh.

- Prevent injury and damage from tripping or driving on raised bolts.
- Easily slide over Fixed Safety Bollards. No hardware required.
- 9-gauge steel construction.



MODEL NO.	DIMENSIONS DIAM. x H	FITS BOLLARD DIAMETER	WT. (LBS.)	PRICE EACH	
				1	4+
H-10463	14 x 3"	4.5"	6	\$45	\$42
H-10464	14 x 3"	5.5"			



## POUR-IN-PLACE

Extra-strong, permanent protection for dock doors and gas stations.

- Installs in 10" of wet concrete.
- For extra stability, remove cap and fill with concrete.
- Four welded anchor tabs keep bollard secure in ground.
- 9-gauge steel construction.

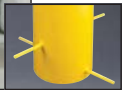

MODEL NO.	DIAMETER	HEIGHT	USABLE HEIGHT	WT. (LBS.)	PRICE EACH	
					1	4+
H-7685		46"	36"	38	\$135	\$130
H-7686	5.5"	52"	42"	44	150	145
H-9089		58"	48"	50	170	165

## SQUARE

Square off warehouse corners with a clean look and heavy-duty protection.

- More surface area and thicker steel than standard bollards.
- Removable black caps. Fill with concrete for extra strength.
- Fixed, permanent installation.
- 9-gauge steel construction.



MODEL NO.	DIAMETER	HEIGHT	MOUNTING PLATE DIM.	WT. (LBS.)	PRICE EACH	
					1	4+
H-8264	4.5"	36"	8 x 8"	33	\$105	\$100
H-8265		42"		38	120	115
H-2121	Concrete Installation Kit (4 Anchors per Kit)				23	21

# BOLLARD SLEEVES

INDOOR/OUTDOOR

Maintenance-free protection with a clean, finished look.

- Stays brighter longer. UV resistant, holds 98% of color for 5 years.
- High-density polyethylene can be trimmed to fit. • Made in the USA.

**Ribbed** – Vertical ribs for greater impact protection.

**Reflective** – Two red reflective stripes for high visibility day or night.

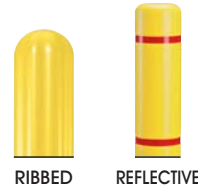

Installation kit included

\*Available in Red and Yellow only

MODEL NO.	DESCRIPTION	SPECIFY COLOR	FITS POST DIAM.	DIAMETER		HT.	PRICE EACH		
				OUTSIDE	INSIDE		1	4	12+
H-9230	Smooth	Blue, Red, Yellow or Black	4"	4 <sup>7</sup> / <sub>8</sub> "	4 <sup>5</sup> / <sub>8</sub> "	56"	\$40	\$39	\$37
H-9231			6"	7 <sup>1</sup> / <sub>4</sub> "	7"	56"	\$43 any quantity		
H-9232*			6"	7 <sup>1</sup> / <sub>4</sub> "	7"	72"	55	54	52
H-9233			8"	9 <sup>3</sup> / <sub>8</sub> "	9 <sup>1</sup> / <sub>8</sub> "	57"	67	66	64
H-3718▲ H-3719▲	Ribbed	Yellow	4" 6"	5 <sup>1</sup> / <sub>2</sub> " 7 <sup>5</sup> / <sub>8</sub> "	4 <sup>3</sup> / <sub>4</sub> " 6 <sup>7</sup> / <sub>8</sub> "	56"	54 61	53 60	51 58
H-6425	Reflective	Yellow	4"	4 <sup>7</sup> / <sub>8</sub> "	4 <sup>5</sup> / <sub>8</sub> "	52"	44	43	41
H-6426			6"	7 <sup>1</sup> / <sub>4</sub> "	7"	52"	51	50	48
H-7857			8"	9 <sup>3</sup> / <sub>8</sub> "	9 <sup>1</sup> / <sub>8</sub> "	52"	84	83	81
H-10621			8"	9 <sup>3</sup> / <sub>8</sub> "	9 <sup>1</sup> / <sub>8</sub> "	72"	100	99	97

▲UV resistant up to 1 year

# COLUMN PROTECTORS

Immediately stop damage to your warehouse columns.

- Lightweight 2-piece poly bumpers install in seconds with hook-and-loop straps.
- Heavy-duty polyethylene construction. • Stackable for added protection.
- Compatible with square, round and I-beam columns.

**Red Mini** – 24" height. Fits under fire extinguishers.

**Lime Green** – Reflective straps for high visibility.



**YELLOW**

SHIPS VIA MOTOR FREIGHT

MODEL NO.	FITS COLUMN	DIMENSIONS DIAM. x H	PRICE EACH	
			1	4+
H-5557 H-987	6" Square 8" Square	26 x 42"	\$295	\$280
H-6340 H-988 H-5558	9" Round 10" Square 12" Square	26 x 42"	295	280

Additional sizes available, see uline.com

**RED MINI**

SHIPS VIA UPS

MODEL NO.	FITS COLUMN	DIMENSIONS DIAM. x H	PRICE EACH	
			1	4+
H-7886 H-7884	8" Square 10" Square	26 x 24"	\$240	\$225

**LIME GREEN**

SHIPS VIA MOTOR FREIGHT

MODEL NO.	FITS COLUMN	DIMENSIONS DIAM. x H	PRICE EACH	
			1	4+
H-7887 H-7885	8" Square 10" Square	26 x 42"	\$315	\$300

# RACK PROTECTORS

**STEEL** – Additional steel sizes, see uline.com

SHIPS VIA UPS

MODEL NO.	DESC.	FITS POST SIZE	HT.	WT. (LBS.)	PRICE EACH			
					1	6	12	24+
H-3720	Steel	4 <sup>1</sup> / <sub>4</sub> " Wide	12"	11	\$34	\$33	\$32	\$29
H-3721			18"	15	41	40	39	37
H-4904			24"	20	50	49	48	46
H-6293	Steel	6 <sup>1</sup> / <sub>2</sub> " Wide	12"	13	40	39	38	36
H-3722	Concrete Installation Kit (4 Anchors/Kit)				5	5	4	4

**PLASTIC**

Sold in multiples of 6

MODEL NO.	DESC.	FITS POST SIZE	HT.	WT. (LBS.)	PRICE EACH			
					1	6	12	24+
H-4078	Plastic	3 x 3"	9"	2	N/A	\$18	\$17	\$16

Prevent rack and shelving damage from forklifts and pallet trucks.

**Steel** – Heavy-duty protection. Sturdy 1/4" thick steel uprights welded to 7" deep base plates.

**Plastic** – Quick, snap-on installation. Stack to your desired height.







# WIRE MACHINE GUARDS

Protect your staff and safeguard your automated equipment.



- Create a perimeter barrier between employees and potential hazards.

Meets OSHA and ANSI Specifications

**Posts** – Welded to 7/16" steel base plates. 2" square, 11-gauge posts. 6 x 6" mounting plates.

**Panels** – Heavy-duty 8-gauge wire mesh panels with 1 3/8" square openings.

**Doors** – Hinged doors provide access. Padlockable.

MODEL NO.	WIDTH	5 1/2" HEIGHT			7 1/2" HEIGHT		
		PRICE EACH		WT. (LBS.)	PRICE EACH		WT. (LBS.)
		1	4+		1	4+	
H-5607	2"	\$85	\$80	19	\$95	\$90	23

**PANELS** – 6" floor clearance

H-5608	2'	\$85	\$80	30	\$110	\$105	34
H-10461	3'	115	105	39	145	135	43
H-5609	4'	140	130	45	170	160	50
H-10462	5'	170	160	53	200	190	60
H-5610	6'	190	180	60	220	210	68
H-5611	8'	220	210	75	255	245	87

**DOORS** – 6" floor clearance

H-5612	4'	\$260	\$245	56	\$295	\$280	64
--------	----	-------	-------	----	-------	-------	----

SHIPS VIA MOTOR FREIGHT



# SAFETY SWING GATES

INDOOR/OUTDOOR

Close dangerous openings on platforms, mezzanines and catwalks.

- Universal design. Right or left application.
- Adjustable width in 2" increments.
- Self-closing stainless steel spring and anti-friction bearings for long life.
- Mounts to round, square or angle rails up to 2" wide or a reinforced wall.

Use with Uline Safety Railings, see page 583

OSHA and ANSI Compliant

MODEL NO.	DESCRIPTION	FITS OPENING	HEIGHT	PRICE EACH		WT. (LBS.)
				1	2+	
H-5615	Adjustable Gate	16 - 26"	21"	\$335	\$325	33
H-5616		24 - 40"		345	335	36

SHIPS VIA UPS



5" HIGH TO PROTECT AGAINST FORKLIFT DAMAGE

# SAFETY CURB

Prevent forklift damage to racks, machinery and inventory.

- Extra heavy-duty 3/8" thick steel.
- Anchor bolts included.
- Line up end-to-end for longer runs.
- Powder-coated OSHA yellow stands out for safety.



MODEL NO.	DESCRIPTION	DIMENSIONS L x D x H	PRICE EACH		WT. (LBS.)
			1	4+	
H-6856	Safety Curb	48 x 3 x 5"	\$125	\$115	38

SHIPS VIA UPS

# END OF RACK PROTECTORS

Low profile, high protection. Prevents forklift damage to side and front of rack ends.

- Extra heavy-duty, 3/8" all-welded steel.
- Anchor bolts included.
- Powder-coated OSHA yellow for high visibility.

MODEL NO.	DESCRIPTION	DIMENSIONS L x D x H	FITS POST SIZE	PRICE EACH		WT. (LBS.)
				1	4+	
H-4905	Right Side	46 x 3 x 5"	4 1/4" Wide	\$155	\$145	53
H-4906	Left Side					

RIGHT SIDE

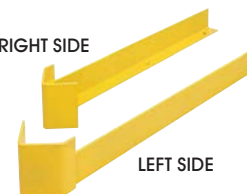

LEFT SIDE



8" HIGH CORNERS

# WIRE SECURITY ROOMS

Protect and control access to work areas, inventory and equipment.

- 10-gauge wire mesh panels with 1 1/2" square openings.
- 2" square, 11-gauge steel posts.
- Hinged door with built-in cylinder lock.
- 1/4" thick steel base plates with 2 mounting holes.

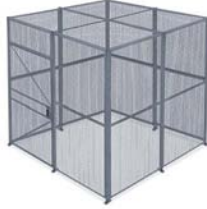

Roof – Maximum protection from theft.



## ROOMS

MODEL NO.	ROOM SIZE L x W	ROOM HEIGHT	2-SIDED	3-SIDED	4-SIDED
			PRICE EACH		
H-7066	8 x 8'	8'	\$1,255	\$1,710	\$2,110
H-7067	12 x 12'		1,780	2,445	2,840
H-7068	16 x 16'		2,110	2,900	3,635
H-8294	8 x 8'	10'	1,515	2,105	2,505
H-8295	12 x 12'		2,175	2,975	3,430
H-8296	16 x 16'		2,505	3,505	4,360

Hardware included

SHIPS UNASSEMBLED VIA MOTOR FREIGHT

## ROOMS WITH ROOF

MODEL NO.	ROOM SIZE L x W	ROOM HEIGHT	2-SIDED	3-SIDED	4-SIDED
			PRICE EACH		
H-8297	8 x 8'	8'	\$1,710	\$2,175	\$2,445
H-8298	12 x 12'		2,765	3,430	3,700
H-8299	16 x 16'		3,700	4,615	5,150
H-8300	8 x 8'	10'	2,045	2,635	2,905
H-8301	12 x 12'		3,370	4,165	4,350
H-8302	16 x 16'		4,350	5,620	6,060

Hardware included

SHIPS UNASSEMBLED VIA MOTOR FREIGHT

## MODULAR – Configure your own

MODEL NO.	DESCRIPTION	WIDTH	HEIGHT	WT. (LBS.)	PRICE EACH	
					1	4+
H-7071	Post	2"	8'	22	\$110	\$105
H-8303			10'	26	135	130
H-9116	Panel	2'	8'	34	145	135
H-9117			10'	42	185	175
H-7070		4'	8'	54	200	190
H-8304			10'	64	255	245
H-7069	Hinged Door	4'	8'	79	275	265
H-8305			10'	88	345	335
H-8306	Sliding Door	4'	8'	84	460	440
H-8307			10'	86	530	505

Panel and door height is 2" shorter than listed

SHIPS VIA MOTOR FREIGHT

## MODULAR

Create enclosures and work areas to fit your specific needs.

- Combine posts, panels and doors.
- Hardware included.

Hinged Door – Swings open left or right.

Sliding Door – For limited spaces. Slides against room to avoid warehouse traffic.

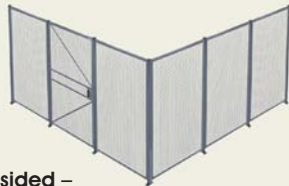
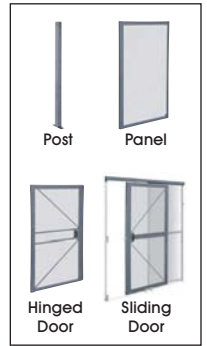

2-sided – Sets up in a corner.

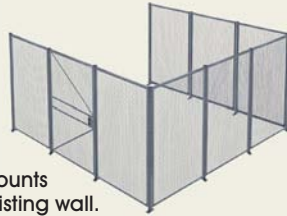

3-sided – Mounts along an existing wall.

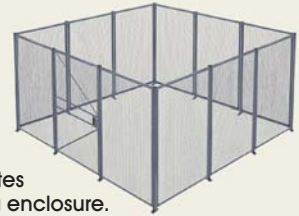

4-sided – Creates a free-standing enclosure.

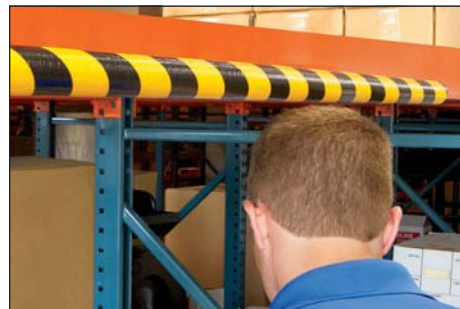



## FOAM BUMPER GUARDS

INDOOR/OUTDOOR

Protect employees from sharp edges in your warehouse.

- Polyurethane foam with self-adhesive strips.

Type B – 5/16 x 3/4" groove slides onto narrow I-beam shelves. Non-adhesive.

MODEL NO.	TYPE	DESCRIPTION	LENGTH	PRICE EACH	
				1	4+
H-4951*	A	Corner Guard 	39"	\$38	\$36
H-4952	B	Edge Guard 			
H-4953	C	Surface Guard 			

\*Also available in Lime/Black

SHIPS VIA UPS



# DOCK LIGHTS

Light up dark trailers and dock areas for safer loading and unloading.

- Double-arm construction for easy maneuvering.
- Outer arm swings horizontally 300 degrees.
- Lamp head pivots up and down.
- Uses up to 300W incandescent or LED bulb.

**Dock Light and Fan Combo** – Lights and cools simultaneously. Adjustable 18" high-velocity fan.



40" REACH



WITH FAN

UL/C-UL Listed

MODEL NO.	DESCRIPTION	REACH	PRICE EACH	
			1	2+
H-1439	Heavy-Duty Double Arm	40"	\$220	\$210
H-2778		60"	250	240
S-21737	15W PAR 38 Flood Lamp (Box of 6)		1 \$18.50/box	3+\$17.50/box

EASY ASSEMBLY. SHIPS VIA UPS.

UL/C-UL Listed

MODEL NO.	DESCRIPTION	REACH	PRICE EACH	
			1	2+
H-5652	Heavy-Duty Double Arm with Fan	40"	\$370	\$355
H-5653		60"	405	390
S-21737	15W PAR 38 Flood Lamp (Box of 6)		1 \$18.50/box	3+\$17.50/box

EASY ASSEMBLY. SHIPS VIA UPS.

## PEDESTRIAN SAFETY LIGHT



Ensure pedestrian safety when backing out of trailers, down aisles and around blind spots.

- Super high-intensity beam projects 15'.
- Two LEDs rated to last 50,000 hours at 830 lumens.
- Shock and impact-resistant aluminum housing. Polycarbonate lens.

- Mount to forklift cage. 14" cable to hard wire.

Meets RoHS, IP68 and CE Standards

MODEL NO.	DESCRIPTION	SIZE W x D x H	VOLTS	PRICE EACH	
				1	3+
H-6390	Blue LED	6 x 3½ x 5"	10-80	\$100	\$90
H-6391	Universal Mounting Bracket			16	15

## MOBILE SAFETY BARRIER



Temporary indoor barrier for stores and offices.

- Flexible panels can be used in curved or straight configurations.
- Curves around hazards and machinery.
- Tilts and rolls easily on two 5" wheels.

- Four locking straps to secure in closed position.

Meets ANSI Standards

MODEL NO.	DESCRIPTION	EXTENDED		FOLDED		WT. (LBS.)	PRICE EACH	
		WIDTH	HT.	WIDTH	HT.		1	2+
H-3038	Mobile	13'	40"	23"	40"	37	\$460	\$440

SHIPS ASSEMBLED VIA UPS

## MAGNETIC RETRACTABLE BARRIERS

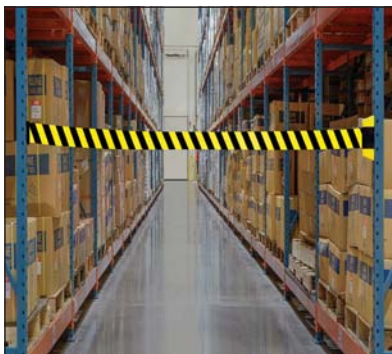

Restrict access to warehouse aisles.

- Powerful magnets fasten to metal. Sets up in seconds.
- ABS plastic housing with 2" wide self-retracting belt.

- No mounting hardware or tools needed.

SPECIFY: Black/Yellow, Red or "Caution"

MODEL NO.	DESCRIPTION	HEIGHT	BELT LENGTH	WT. (LBS.)	PRICE EACH	
					1	5+
H-5875	Magnetic	5½"	15'	2	\$105	\$95
H-7078		6¼"	30'	3	190	170

## SAFETY BARRIERS



Temporarily restrict access and ensure warehouse safety.

- Lightweight steel construction.
- Convenient attached handle.
- H-2734 – Four 2" locking swivel casters for easy mobility.

- End connectors link barriers together for longer lengths.

EASY ASSEMBLY. SHIPS VIA UPS.

MODEL NO.	DESCRIPTION	EXTENDED		FOLDED		WT. (LBS.)	PRICE EACH	
		WIDTH	HT.	WIDTH	HT.		1	2+
H-2733	Fixed	11' 8"	37"	15"	37"	46	\$300	\$280
H-2734	Mobile	11' 8"	40"	15"	40"	49	325	300



# SAFETY RAILINGS

Keep employees safe on walkways, mezzanines and drop-offs.

- Heavy duty 1 5/8" diameter pipe with 21" high welded midrail.

Steel – Powder coated. Choice of OSHA yellow for safety or classic black.

Aluminum – Superior corrosion resistance.

## RAILING SECTIONS

\*SPECIFY COLOR: Yellow or Black

MODEL NO.	DESCRIPTION	LENGTH	HEIGHT	WT. (LBS.)	PRICE EACH	
					1	4+
H-6296*	Powder-Coated Steel	3'	42"	20	\$105	\$100
H-4976*		4'	42"	22	120	110
H-4977*		6'	42"	29	130	120
H-4978*		8'	42"	35	145	135
H-6297*		10'	42"	42	155	145
H-6298	Aluminum	4'	42"	8	190	180
H-6299		6'	42"	10	230	220
H-6300		8'	42"	12	270	260

SHIPS VIA MOTOR FREIGHT



- Double mounting sockets make it easy to extend length and make turns.



## MOUNTING SOCKETS

MODEL NO.	DESCRIPTION	MOUNTING PLATE DIMENSIONS	WT. (LBS.)	PRICE EACH	
				1	4+
H-4979	Single	5 x 5"	6	\$28	\$27
H-4980	Double	7 1/2 x 5"	10	48	47

Sockets include 4 concrete anchors

SHIPS VIA UPS



# PORTABLE SAFETY BARRIERS

Temporarily manage foot traffic around job sites, festivals and sporting events.

- Barriers interlock to create long runs.
- Easy to set up and take down.
- Welded 1 1/4" diameter frame with 5/8" diameter uprights.
- Removable feet for easy stacking and storage.



Flat Feet – Sit flush on ground to prevent tripping in high-traffic areas.



Bridge Feet – Keep barrier level on grass and uneven ground.

**POWDER COATED** – Safety yellow for greater visibility.

MODEL NO.	DESCRIPTION	FOOT STYLE	SIZE L x H	WT. (LBS.)	PRICE EACH	
					1	4+
H-8269	Powder Coated	Flat	8 1/2" x 40"	33	\$135	\$125
H-7087	Powder Coated	Bridge	8 1/2" x 40"	31		

SHIPS UNASSEMBLED VIA MOTOR FREIGHT

**GALVANIZED** – Hot dipped. Excellent rust resistance.

MODEL NO.	DESCRIPTION	FOOT STYLE	SIZE L x H	WT. (LBS.)	PRICE EACH	
					1	4+
H-8270	Galvanized	Flat	8 1/2" x 40"	35	\$145	\$135
H-7086		Bridge		33		

SHIPS UNASSEMBLED VIA MOTOR FREIGHT

# DOCK SAFETY GATES



Keep employees and forklifts on your docks!

- Heavy duty steel pipe with welded midrail.
- Mounts to floor and swings open on smooth-rolling wheel.
- Foot-release lock secures gate in closed position.

Hardware included

MODEL NO.	DESCRIPTION	LENGTH	HEIGHT	WT. (LBS.)	PRICE EACH	
					1	4+
H-7614	Safety Gate	8'	45"	47	\$215	\$205
H-7615		10'		51	225	215

SHIPS VIA MOTOR FREIGHT

# OVERHEAD DOOR TRACK PROTECTORS

Prevent costly damage from forklifts and pallet trucks to your dock door.

- 3/16" steel uprights welded to 1/4" thick steel base plates.
- Optional floor and wall mounting hardware available.



Additional sizes, see [uline.com](http://uline.com)

MODEL NO.	DESCRIPTION	HT.	MOUNTING PLATE DIMENSIONS	WT. (LBS.)	PRICE EACH	
					1	6+
H-5561	Left Side	48"	10 x 8"	40	\$94	\$88
H-5562	Right Side					
H-5563	Mounting Hardware					

SHIPS VIA UPS

# HIGH-SECURITY FOLDING GATES

Protect commercial buildings and retail property in rough neighborhoods.

- Up to 60% heavier for a stronger, more secure barrier.
- Tight 14-gauge webbing uses 30% more steel. 12-gauge steel frame.
- Black powder-coat finish. • Center-drop pins stabilize door when closed.
- Gates pivot and swing 180° for unobstructed access.



Each set includes casters, bearing washers and brackets.

MODEL NO.	DESC.	EXTENDED		FOLDED		WT. (LBS.)	PRICE PER SET	
		WIDTH	HT.	WIDTH	HT.		1	2+
H-7608	Fixed Double	8-10'	6'	11"	6½'	100	\$440	\$425
H-7609		10-12'				110	485	470
H-7610		12-14'				120	550	530
H-9140		14-16'				130	625	605

SHIPS VIA MOTOR FREIGHT

# SAFETY BARRICADE GATES

MOBILE

Heavy-duty barrier prevents access to restricted areas in warehouses or wholesale clubs.

- Extends to a full 20' length. Folds down to a compact 25".
- Yellow powder-coat finish. 16-gauge steel webbing with 14-gauge frame.
- Two end handles for easy mobility. • Optional safety sign.
- Security chains secure gate to wall or racking.



Six 5" swivel casters. Four lock to secure gate position.



MODEL NO.	DESC.	EXTENDED		FOLDED		WT. (LBS.)	PRICE EACH		
		WIDTH	HT.	WIDTH	HT.		1	2+	
■H-7604	Gate	20'	4½'	25"	5½'	126	\$465	\$445	
■H-9141			6'		7'		165	555	535
S-22886P	Sign	7 x 10" Plastic						\$17 each	

■ SHIPS VIA MOTOR FREIGHT

# INDUSTRIAL CURTAIN WALLS

Create temporary walls for dust, noise and climate control in warehouses.

- Polyester reinforced vinyl with clear PVC center for visibility.
- 12' of track, rollers and mounting brackets included. Weighted bottom hem.
- Connect multiple curtains with Velcro® edge for larger areas.
- Meets NFPA-701 standards.



H-4955

MODEL NO.	SIZE W x H	COLOR	WT. (LBS.)	PRICE EACH	
				1	3+
H-4954	12 x 8'	Blue/Clear/Blue	41	\$340	\$325
H-4955	12 x 10'		44	375	360
H-6337	12 x 12'		48	405	390
H-6338	12 x 8'	Solid Blue	41	370	355
H-6339	12 x 10'		44	400	385

SHIPS VIA UPS

# UTILITY CARTS WITH CABINET

One tough cart. Sturdy and secure storage for your valuable tools and equipment.

- Steel panels securely fasten to structural foam cart. • 2⅝" deep top tray.
- Locking cabinet doors with rear cord grommet. • 2 swivel, 2 rigid casters.
- Complete line of Utility Carts, see page 434.



H-8315

EASY ASSEMBLY. SHIPS VIA UPS. SPECIFY PANEL COLOR: Red or Gray

MODEL NO.	WHEEL TYPE	DIMENSIONS L x W x H	LOAD CAP.	WT. (LBS.)	PRICE EACH	
					1	3+
H-8314	5" Rubber	45 x 25 x 33"	500 lbs.	70	\$280	\$270
H-8315	8" Pneumatic	45 x 25 x 37"			435	415



# FOLDING SECURITY GATES

Control access to hallways and receiving doors without affecting ventilation or visibility.

- Corrosion-resistant, 15-gauge, galvanized steel webbing. 12-gauge steel frame.
- Gates pivot and swing 180° for unobstructed access.
- Includes bearing washers, brackets and casters.

**Fixed Single** – Sized for pedestrian entryways and doors.

**Fixed Double** – For garage and dock entries. Center drop pin stabilizes door when closed.

**Heavy Duty** – For extra-wide receiving doors and storefronts. Fixed Double with 14" axles and 2" rubber casters for extra stability.

**Window** – Fixed single gate for storefront windows. No casters. Mounts inside or outside.

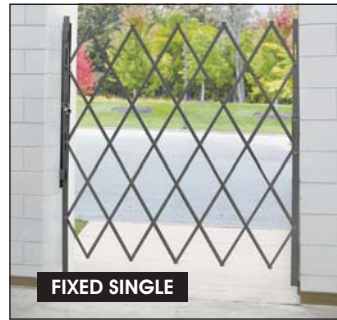
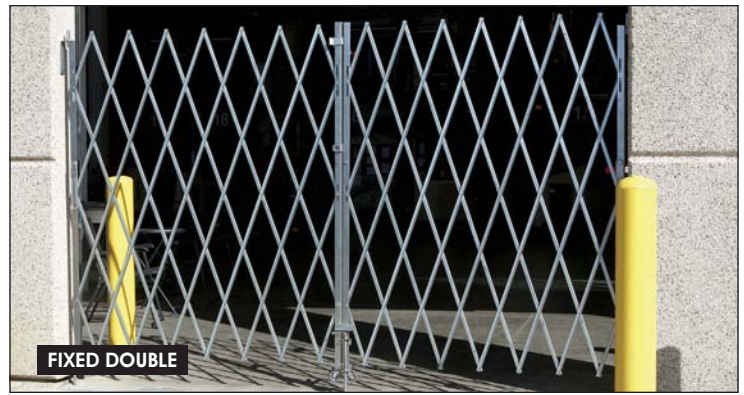

MODEL NO.	DESC.	EXTENDED		FOLDED		WT. (LBS.)	PRICE PER SET	
		WIDTH	HT.	WIDTH	HT.		1	2+
H-6937*	Window	3-4'	31"	11"	37"	20	\$130	\$125
H-6938*			43"		49"	23	145	140
H-3691*	Fixed Single	3-4'				31	190	180
H-3693*		5-6'	6'	11"	6½'	36	245	235
H-4890*		7-8'				47	280	270
H-6371*	Fixed Single	3-4'				40	255	245
H-6372*		5-6'	7'	11"	7½'	52	285	275
H-6373		7-8'				63	335	320
H-2827*	Fixed Double	6-8'				56	310	300
H-2828		8-10'				62	360	345
H-2829		10-12'				69	385	370
H-3419		12-14'	6'	11"	6½'	82	450	435
H-3694		14-16'				89	505	485
H-4099		16-18'				97	545	520
H-4891		18-20'				99	580	555

\* SHIPS VIA UPS

SHIPS VIA MOTOR FREIGHT

MODEL NO.	DESC.	EXTENDED		FOLDED		WT. (LBS.)	PRICE PER SET	
		WIDTH	HT.	WIDTH	HT.		1	2+
H-2830	Fixed Double	8-10'				86	\$405	\$390
H-3696		10-12'	7'	11"	7½'	90	465	445
H-3420		12-14'				108	515	495
H-4892		18-20'				134	695	665
H-4893	Fixed Double	8-10'				98	450	435
H-4894		10-12'				108	550	525
H-4895		12-14'	8'	11"	8½'	118	615	590
H-5629		14-16'				135	655	625
H-6374		16-18'				142	695	665
H-8202		18-20'				150	730	700
H-6375	Heavy Duty	20-22'	6'	20"	6½'	143	845	810
H-6376		22-24'				149	900	865
H-6377	Heavy Duty	20-22'	7'	20"	7½'	192	1,000	960
H-6378		22-24'				201	1,060	1,020

SHIPS VIA MOTOR FREIGHT

# PORTABLE FOLDING SECURITY GATE



Secure and protect property wherever you need it.

- Collapses and rolls out of sight. Fits through most doorways. Indoor/outdoor use.
- Corrosion-resistant, galvanized steel webbing.

**Starter** – Includes hardware and two 12" locking bars that mount to walls.

**Add-On** – Bolts to Starter and adds 6'. Includes hardware.

MODEL NO.	DESC.	EXTENDED		FOLDED		WT. (LBS.)	PRICE EACH	
		WIDTH	HT.	WIDTH	HT.		1	2+
H-4104	Starter	12'	6'	20"	6½'	80	\$570	\$550

MODEL NO.	DESC.	EXTENDED		FOLDED		WT. (LBS.)	PRICE EACH	
		WIDTH	HT.	WIDTH	HT.		1	2+
H-4105	Add-On	6'	6'	11"	6½'	40	\$325	\$315

SHIPS VIA MOTOR FREIGHT



# SAFETY MIRRORS



CONVEX H-1307

Eliminate blind spots in warehouses and offices. Prevent collisions at corners, intersections and aisles. Lightweight and easy to install.

Indoor – Crisp, clear glass. Adjustable swivel mount.

Outdoor – Shatterproof acrylic. Weatherproof and impact resistant.

**Convex** – 2 way. Wide angle 160° view for receiving areas and blind warehouse corners.

**Jumbo Convex** – 2 way. View wide open spaces around warehouses and industrial plants.

**Low Clearance Convex** – 2 way. Rounded, rectangular-shaped. For elevators and low ceilings.

**Flat** – Distortion-free image reflection with accurate depth perception. For small aisles or areas with broader visibility.

**Quarter-Dome** – 2 way. Mounts snugly in corner. Shatterproof acrylic. For 90° views at "L" intersections.



QUARTER



HALF

**Half-Dome** – 3 way. Mounts at intersection of wall and ceiling. Shatterproof acrylic. For entrances and exits.



FULL

**Full-Dome** – 4 way. Panoramic 360°. Shatterproof acrylic. Reduce warehouse accidents and retail theft.

Convex/Flat Mounting Hardware \$12 H-1307-MOUNT



JUMBO CONVEX H-2076



LOW CLEARANCE H-1549



FLAT H-5566

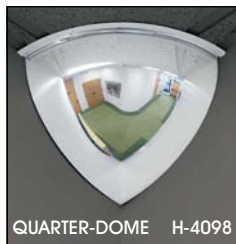

QUARTER-DOME H-4098



HALF-DOME H-1308



FULL-DOME H-1884

MODEL NO.	DESCRIPTION	SIZE	WT. (LBS.)	VIEW	INDOOR PRICE EACH		OUTDOOR PRICE EACH	
					1	3+	1	3+
H-1547	Convex	12"	5	160°	\$35	\$33	\$43	\$41
H-1307		18"	7		48	46	61	59
H-1548		26"	15		97	94	122	118
H-2076	Jumbo Convex	30"	18	160°	135	130	175	170
H-1882		36"	24		165	160	210	200
H-1549	Low Clearance	12 x 18"	6	160°	52	50	79	75
H-4096		20 x 30"	21		115	110	175	167
H-4097		24 x 36"	25		160	155	220	210
H-5566	Flat	16 x 24"	14	N/A	86	82	120	115
H-4098	Quarter-Dome Acrylic	18"	3	90°	33	31	33	31
H-1308	Half-Dome Acrylic	18"	4	180°	46	44	46	44
H-2077		26"	7		86	82	86	82
H-1883		36"	12		140	130	140	130
H-1884	Full-Dome Acrylic	18"	6	360°	66	63	66	63
H-2078		26"	10		120	115	120	115
H-10526		32"	14		190	180	190	180
■ H-1885		36"	19		220	210	220	210
■ H-9220		48"	26		350	340	350	340

■ SHIPS VIA MOTOR FREIGHT

# WARNING SAFETY MIRRORS

INDOOR/OUTDOOR



CONVEX WARNING H-9724

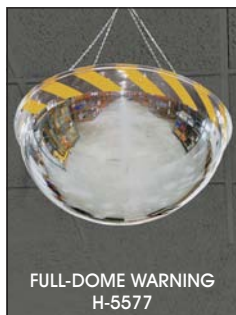

FULL-DOME WARNING H-5577

Provide visibility and caution around busy warehouses and manufacturing plants.

- Shatterproof acrylic.
- High-visibility black and yellow stripes stand out.

**Convex** – 2 way. Wide angle 160° view. Adjustable swivel mount.

**Full-Dome** – 4 way. Panoramic 360°. 6 center wires for hanging.

Mounting hardware and chain sold separately

MODEL NO.	DESCRIPTION	SIZE	WT. (LBS.)	VIEW	PRICE EACH	
					1	3+
H-9724	Convex Warning	36"	18	160°	\$210	\$200
■ H-5577	Full-Dome Warning	36"	20	360°	260	250

■ SHIPS VIA MOTOR FREIGHT

# VINYL STRIP DOOR KITS

## SMOOTH

MODEL NO.	DOOR SIZE W x H	STRIP SIZE		OVERLAP %	PRICE EACH
		WIDTH	THICKNESS		
H-2072	3 x 7'	8"	.080"	50%	\$135
H-2074	4 x 7'	8"	.080"	50%	170
H-1880	4 x 8'	8"	.080"	50%	190
H-2466	5 x 7'	8"	.080"	50%	210
H-3666	6 x 7'	8"	.080"	50%	255
H-1092	6 x 8'	8"	.080"	50%	270
H-1093	8 x 8'	8"	.080"	50%	340
■H-2075	8 x 8'	12"	.120"	67%	445
■H-1094	8 x 10'	12"	.120"	67%	480
■H-3667	10 x 8'	12"	.120"	67%	505
■H-1095	10 x 10'	12"	.120"	67%	605
■H-1409	10 x 12'	12"	.120"	67%	685
■H-5567	12 x 10'	12"	.120"	67%	685
■H-1410	12 x 12'	12"	.120"	67%	825
■H-2814	12 x 14'	12"	.120"	67%	965
■H-2467	14 x 12'	12"	.120"	67%	965
■H-4782	14 x 14'	12"	.120"	67%	1,070

■ SHIPS VIA MOTOR FREIGHT

## SCRATCH RESISTANT

H-2815	6 x 8'	8"	.080"	50%	\$310
H-2816	8 x 8'	8"	.080"	50%	405
■H-2817	8 x 10'	12"	.120"	67%	615
■H-9708	10 x 8'	12"	.120"	67%	705
■H-2818	10 x 10'	12"	.120"	67%	765
■H-3668	10 x 12'	12"	.120"	67%	860
■H-5568	12 x 10'	12"	.120"	67%	860
■H-2819	12 x 12'	12"	.120"	67%	1,020
■H-3669	12 x 14'	12"	.120"	67%	1,170
■H-7874	14 x 14'	12"	.120"	67%	1,305

■ SHIPS VIA MOTOR FREIGHT

## LOW TEMP

H-3203	6 x 8'	8"	.080"	50%	\$280
H-3204	8 x 8'	8"	.080"	50%	355
■H-3205	8 x 10'	12"	.120"	67%	540
■H-3206	10 x 10'	12"	.120"	67%	660
■H-10525	10 x 12'	12"	.120"	67%	815

■ SHIPS VIA MOTOR FREIGHT

## REPLACEMENT ROLLS

MODEL NO.	DESCRIPTION	STRIP SIZE		STRIP LENGTH	PRICE EACH
		WIDTH	THICKNESS		
H-1881	Smooth	8"	.080"	150'	\$185
■H-1411		8"	.080"	300'	355
■H-1412		12"	.120"	150'	405
■H-3670		16"	.160"	100'	500
H-2820	Scratch Resistant	8"	.080"	150'	215
■H-2821		12"	.120"	150'	480
H-3212	Low Temp	8"	.080"	150'	200
■H-3213		12"	.120"	150'	430

■ SHIPS VIA MOTOR FREIGHT



SMOOTH

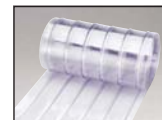

SCRATCH RESISTANT

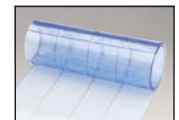

LOW TEMP

Prevent dust, cold air and noise from moving between separated areas. PVC vinyl.

Lower heating and cooling bills; reduce noise.

**Smooth Strips** – Clear for two-way visibility.

**Scratch Resistant** – Ribbed. Heavy duty. Stays clear 20% longer.

**Low Temp** – Stays flexible down to -20°F. Use in coolers, freezers and USDA-inspected facilities. Nylon reinforced.

**Amber and Black available, see uline.com**

**Replacement Strips** – Individual pre-cut strips on a roll. Mounting holes pre-punched on 2" centers.

All strip door kits include aluminum mounting brackets.

## REPLACEMENT STRIPS

MODEL NO.	DESCRIPTION	STRIP SIZE			QTY./ CASE	PRICE/ CASE
		LENGTH	WIDTH	THICKNESS		
H-3671	Smooth	7'	8"	.080"	10	\$131
H-3672		8'	8"	.080"	9	135
H-3673		8'	12"	.120"	9	250
H-3674		10'	12"	.120"	7	255
H-3675		12'	12"	.120"	6	270
H-3676		14'	12"	.120"	5	270
H-6310	Scratch Resistant	10'	12"	.120"	7	290
H-6311		12'	12"	.120"	6	310



## GANTRY CRANES

Safely hold and position generators, HVAC systems and industrial motors.

- Recommended for contractors, machine shops and automotive garages.
- Holds up to a ton. Easily set up and roll into position.
- Lightweight, corrosion-resistant aluminum construction.
- Height adjusts in 6" increments. • 8" locking phenolic casters.



Hoist Trolleys, uline.com

### INDOOR/OUTDOOR

MODEL NO.	CAPACITY	OVERALL LENGTH	USABLE LENGTH	ADJUSTABLE HEIGHT	I-BEAM		WT. (LBS.)	PRICE EACH	
					HEIGHT	WIDTH		1	2+
H-8463	1 Ton	8'	6'8"	7'8" - 10'2"	6"	3 1/4"	195	\$2,625	
H-8464		10'	8'8"					205	2,785

SHIPS UNASSEMBLED VIA MOTOR FREIGHT



## FLOOR CRANE

Raise, lower and transport heavy items with minimal effort.

- Recommended for engines, compressors and transmissions.
- Used by machinists, mechanics and freight handlers.
- Pump the lever to raise the boom. Extends for greater reach.
- Six steel swivel casters maneuver into tight spaces.



Folds for convenient storage

### HYDRAULIC

MODEL NO.	CAPACITY*		BOOM REACH		MAX. HOOK HEIGHT	WT. (LBS.)	PRICE EACH	
	RETRACTED	EXTENDED	RETRACTED	EXTENDED			1	2+
H-8462	2 Tons	1/2 Ton	40 1/2"	61 3/4"	88"	200	\$510	\$490

\*As boom extends, capacity decreases

SHIPS UNASSEMBLED VIA MOTOR FREIGHT

## WHEEL RISER RAMPS

Safely raise trailers to dock height for easy loading and unloading.



H-4189

- Diamond plate, nonslip surface.
- Heavy-duty welded aluminum.

- 15,000 lb. capacity per ramp.
- Designed to comply with OSHA requirements.

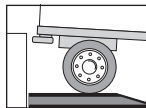

MODEL NO.	OVERALL SIZE H x W x L	LEVEL LENGTH	WT. (LBS.)	PRICE EACH	
				1	4+
H-4189	6 x 18 x 48"	30"	39	\$615	\$595
H-4190	8 x 18 x 54"	30"	55	700	680
H-4191	6 x 24 x 48"	30"	59	715	695
H-4192	12 x 24 x 72"	36"	133	1,230	1,195

SHIPS VIA MOTOR FREIGHT

## TRANSPORT CHAINS New



Secure heavy and unstable loads to construction and landscape trailers.

- Heavy-duty tie-down chains recommended for truckers, highway crews and farmers.
- Zinc-plated Grade 70 chain. 2 grab hooks.
- Withstands sharp and abrasive cargo.
- Meets D.O.T. and CVSA specifications.



Not for overhead lifting

MODEL NO.	DESCRIPTION	LENGTH	CAPACITY (LBS.)	WT. (LBS.)	PRICE EACH	
					1	4+
H-10449	5/16" Chain	20'	18,800	22	\$95	\$90
H-10450	3/8" Chain		26,400	33	125	120

## PALLET PULLER

Pull hard-to-reach pallets from truck beds to forklift range. Do not use for lifting.



- Self-cleaning steel jaws. Chain included.



H-127 INDUSTRIAL – Pulls up to 5,000 lbs.

MODEL NO.	DESCRIPTION	CHAIN LENGTH	GRIPPER HEAD SIZE	WT. (LBS.)	PRICE EACH	
					1	2+
H-127	Pallet Puller	30"	2 3/4"	21	\$120	\$115

MODEL NO.	DESCRIPTION	WT. (LBS.)	PRICE EACH
H-130	20 ft. chain	15	\$65
H-132	40 ft. chain	29	110

**PULL CHAINS:** 1/4" proof coil chain has a grab hook at each end. Pull capacity of 5,000 lbs.



# WHEEL CHOCKS

KEEP YOUR LOADING DOCKS SAFE



H-1591  
LAMINATED



H-1590  
ALUMINUM

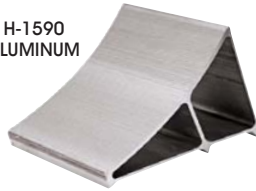

H-1589  
URETHANE



H-517  
RUBBER



MODEL NO.	DESCRIPTION	SIZE W x D x H	WT. (LBS.)	PRICE PER CHOCK	
				2	10+
H-517	Black Rubber	9 3/4" x 8" x 6"	9	\$20 any qty.	
H-4785	Orange Rubber	9 3/4" x 8" x 6"	9	\$25	\$23
H-1589	Urethane	8 x 11 x 8"	4	34	32
H-1590	Aluminum	7 x 10 x 8"	7	68	65
H-1591	Laminated	8 x 8 x 8"	15	35	33

Sold in multiples of 2

**Rubber – Rugged. Safe, secure grip.**

**Urethane – High visibility. Resists oils and chemicals.**

**Aluminum – Lightweight, durable. Cleats anchor to surfaces. Recommended for ice and cold weather.**

**Laminated Rubber – The "ultimate." Will not slip or creep. Heavier, thicker, solid.**

## CHOCKS WITH HANDLES

Grab and go with easy-carry handle.

**Rubber – For vans and small trailers.**

**Steel – Long-lasting, all-weather chock.**



RUBBER



STEEL

MODEL NO.	DESCRIPTION	SIZE W x D x H	WT. (LBS.)	PRICE PER CHOCK	
				2	10+
H-4193	Rubber	4 1/2" x 10 1/2" x 7"	8	\$14	\$13
H-4194	Steel	7 1/2" x 7 1/2" x 8 1/2"	7	31	29

Sold in multiples of 2

## CHOCK WITH LONG HANDLE

Save your back while moving chock in and out of position.



36" curved, steel tube handle with rubber chock.

Yellow powder-coated finish. Rubber grip.



SPECIFY CHOCK COLOR: Orange or Black

MODEL NO.	DESCRIPTION	CHOCK SIZE W x D x H	WT. (LBS.)	PRICE PER CHOCK	
				2	10+
H-9531	Rubber	9 3/4" x 8" x 6"	13	\$50	\$47

SHIPS UNASSEMBLED VIA UPS

Sold in multiples of 2

## SECURITY CHAIN

Secure to dock walls to prevent theft.

- Fasten to eyebolt on side of chock or wrap chain through.
- Galvanized steel resists rust.



Chock not included

MODEL NO.	DESCRIPTION	LENGTH	WT. (LBS.)	PRICE EACH	
				2	10+
H-546	Chain	15'	3	\$28	\$27

Sold in multiples of 2

## CHOCK HOLDER

Keep track of your chocks.

- Mount to dock wall for convenient, visible storage.
- Yellow powder-coated steel.
- Pre-drilled holes for easy mounting.



Chock not included

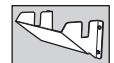

MODEL NO.	DESCRIPTION	SIZE W x D x H	WT. (LBS.)	PRICE EACH	
				2	10+
H-9549	Holder	13 x 8 x 7"	4	\$17	\$16

Sold in multiples of 2

## AIRCRAFT WHEEL CHOCK

Keep airplanes, RVs and boat trailers securely parked. Safety reflectors for visibility.

- Twin rubber chocks connected by 36" rope for easy handling.

MODEL NO.	DESCRIPTION	SIZE W x D x H	WT. (LBS.)	PRICE EACH	
				2	10+
H-4196	Rubber	10 x 5 x 4 1/2"	15	\$50	\$47

- Designed to chock both sides of wheel.



# ULINE TIE-DOWNS

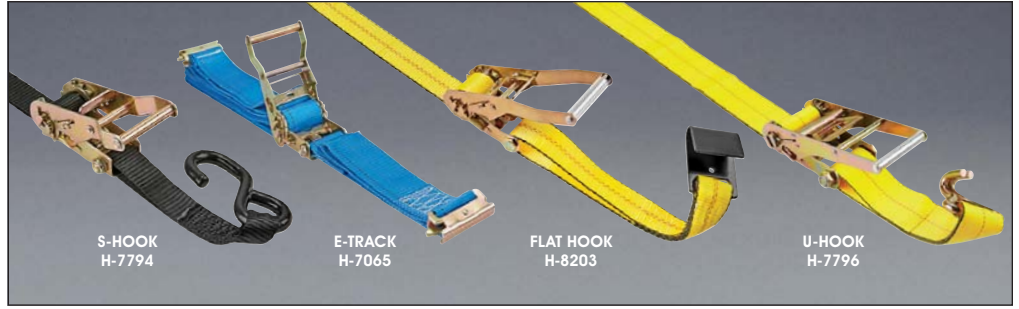

Secure and ship rail, truck and trailer loads.



**S-Hook Ratchets:**  
Poly-coated hooks won't scratch cargo.



**E-Track Ratchets:**  
Snap into trailer fitting. Spring loaded.



**Flat Hook Ratchets:**  
Secure loads on flatbed trailers.



**U-Hook Ratchets:**  
Attach quickly to round rings, small holes.



**Endless Ratchet:**  
Continuous loop stabilizes loads.



**Snap Hook Ratchets:**  
Spring-loaded hook latches to anchor point.



**Delta Ring Ratchets:**  
Fasten to hooks on flatbeds or trailers.

**Cam Buckles:** Flip up lever and pull strap to tighten or loosen.

**Winch Straps:** Attach to winch tensioner on side of trailer.

**Retractable S-Hook Ratchets:** Strap winds up neatly with the push of a button.

## RATCHETS

MODEL NO.	FITTING STYLE	SIZE W x L	RECOMMENDED USES	CAPACITY (LBS.)	PRICE EACH		
					1	4+	
H-9710	S-Hook	1" x 10'	Light duty trucks, trailers, loose loads	2,100	\$11	\$10	
H-7794		1" x 15'		2,100	13	12	
H-10481		2" x 15'		3,000	15	14	
H-7063	E-Track	2" x 12'	E-Track fitting in trailers	3,000	21	19	
H-7064		2" x 16'			23	21	
H-7065		2" x 20'			25	23	
H-9711		2" x 27'			27	25	
H-8203	Flat Hook	2" x 27'	Trailers and flatbeds	10,000	26	24	
H-8209		4" x 27'			69	66	
H-7795	U-Hook	2" x 15'	Trailers with load rings	5,000	24	22	
H-9712		2" x 27'			5,000	25	23
H-7796		2" x 27'			10,000	27	25
H-7797		4" x 27'			15,000	80	77
H-10482	Endless	2" x 27'	Loose loads on pallets	5,000	24	22	
H-8210	Snap Hook	2" x 15'	Trailers, flatbeds and trucks with load rings	5,000	25	23	
H-8211		2" x 27'			28	26	
H-10483	Delta Ring	2" x 15'	Trailers and flatbeds	5,000	24	22	
H-10484		2" x 27'			10,000	27	25

## CAM BUCKLES

H-10452	S-Hook	1" x 15'	Light duty trucks or trailers	1,200	\$10	\$9
H-8212	E-Track	2" x 12'	E-Track fitting in trailers	2,500	13	12
H-8213		2" x 16'			14	13
H-9713		2" x 20'			16	15
H-10451	Endless	1" x 15'	Loose loads on pallets	1,000	9	8

## WINCH STRAPS

H-7051	Flat Hook	4" x 27'	Flatbeds with winches	15,000	\$31	\$29
H-10447		4" x 30'			16,200	33

## RETRACTABLE RATCHETS

H-9706	S-Hook	1" x 6'	Light duty trucks, trailers, loose loads	1,500	\$14	\$13
H-9152		1" x 10'		1,200	16	15
H-9153		2" x 10'		3,300	25	23

# LIFTALL® TIE-DOWNS



## RATCHETS

MODEL NO.	FITTING STYLE	SIZE W x L	RECOMMENDED USES	CAPACITY (LBS.)	PRICE EACH	
					1	4+
H-2068 H-1795	S-Hook	1" x 10' 1" x 15'	Light duty trucks, trailers, loose loads	2,100	\$16 18	\$15 17
H-1415 H-1598 H-1796 H-4781	E-Track	2" x 12' 2" x 16' 2" x 20' 2" x 27'	E-Track fitting in trailers	3,000	27 29 32 36	25 27 30 34
H-2740 H-1217 H-2069	Flat Hook	2" x 12' 2" x 27' 4" x 27'	Trailers and flatbeds	10,000 10,000 15,000	33 38 100	31 36 96
H-2464 H-2070 H-3339 H-3340	U-Hook	2" x 15' 2" x 27' 2" x 27' 4" x 27'	Trailers with load rings	5,000 5,000 10,000 15,000	34 37 40 111	32 35 38 106
H-3341 H-3342	Endless	2" x 12' 2" x 27'	Loose loads on pallets	5,000	26 32	24 30

Quickly secure and ship rail, truck and trailer loads. Spring-loaded ratchet buckles tension and release loads.

**S-Hook Ratchets:** Poly-coated hooks. Won't scratch loads.

**E-Track Ratchets:** Snap into trailer fitting.

**Flat Hook Ratchets:** Secure loads on flatbed trailers.

**U-Hook Ratchets:** Attach quickly to round rings, small holes.

**Endless Ratchets:** Continuous loop stabilizes loads.



## CAM BUCKLES

MODEL NO.	FITTING STYLE	SIZE W x L	RECOMMENDED USES	CAPACITY (LBS.)	PRICE EACH	
					1	4+
H-2465 H-1797 H-1599	E-Track	2" x 12' 2" x 16' 2" x 20'	E-Track fitting in trailers	2,500	\$19 21 23	\$18 20 21
H-5564 H-5565	Endless	1" x 10' 1" x 15'	Vehicle roof racks, loose loads on pallets	1,000	11 12	10 11

**Cam Buckles:** Flip up lever and pull strap to tighten or loosen. Endless loop stabilizes loads.

## WINCH STRAPS

MODEL NO.	FITTING STYLE	SIZE W x L	RECOMMENDED USES	CAPACITY (LBS.)	PRICE EACH	
					1	4+
H-4064 H-1416	Flat Hook	2" x 27' 4" x 27'	Flatbeds with winches	10,000 15,000	\$29 40	\$27 38

**Winch Straps:** Attach to winch tensioner on side of trailer.



## E-TRACK RAILS

MODEL NO.	DESCRIPTION	SIZE W x L	RECOMMENDED USES	CAPACITY (LBS.)	PRICE EACH	
					1	4+
H-3598 H-3599	Powder-Coated Zinc-Plated	5" x 5'	Trailers and cargo vans	6,000	\$20 23	\$19 22

**E-Track Rails:** Mount to inside wall of trucks. Secures E-Track Tie-Downs and Load Bars.



## E-TRACK CARGO NET

MODEL NO.	FITTING STYLE	SIZE H x W	RECOMMENDED USES	CAPACITY (LBS.)	PRICE EACH	
					1	4+
H-6356	E-Track	42" x 10'	E-Track fitting in trailers	5,000	\$180	\$175

**E-Track Cargo Net:** Prevents cargo from shifting during transit. 3 quick-release cam buckles.



# DEWALT® TOOL SETS

PROFESSIONAL



H-10043

Goes in the back of your Ford F-150®.

- Durable, polished chrome-vanadium steel.
- Quickly tighten bolts. Ratchets engage with just a 5° turn.
- Trademarked socket design reduces bolt damage.
- Durable plastic case with sturdy metal latches.

Includes: Ratchet handles, sockets, combination wrenches, drive socket bits, hex keys and more.

Meets ANSI and ASME specifications

Lifetime Warranty

MODEL NO.	DESCRIPTION	CASE SIZE W x H x D	WT. (LBS.)	PRICE EACH	
				1	3+
H-10043	142-Piece Set	19 x 14 x 4"	22	\$170	\$165
H-10044	204-Piece Set	22 x 18 x 4"	38	290	280



## ULINE HAND TOOLS

Essential tools used in every facility and workshop.

**Hammer** – Shock-absorbing fiberglass core. Smooth face.

**6-Piece Screwdriver Set** – Includes slotted 3/16", 1/4", 5/16", Phillips 1, 2, 3.

**5-Piece Pliers Set** – Includes 8" groove joint, 6" slip joint, 6" diagonal, 6" bent nose, 6" long nose.



Comfort Grip

Magnetic Tool Holder



MODEL NO.	DESCRIPTION	PRICE EACH	
		1	4+
H-6408	16 oz. Hammer	\$14	\$13
H-6409	6-Piece Screwdriver Set	22	21
H-6410	5-Piece Pliers Set	42	40
H-6411	24" Magnetic Tool Holder	27	25

## ULINE HI-VIS TIE-DOWNS

Easy-to-see neon green is bright in the daylight and reflective at night.

- Secure and ship rail, truck and trailer loads.

**S-Hook:** Poly-coated hooks won't scratch cargo.

**E-Track:** Snap into trailer fitting. Spring loaded.

**U-Hook:** Attach quickly to round rings, small holes.

**Winch Strap:** Attach to winch tensioner on side of trailers.



S-HOOK



E-TRACK



U-HOOK



FLAT HOOK

### RATCHETS

MODEL NO.	FITTING STYLE	SIZE W x L	RECOMMENDED USES	CAPACITY (LBS.)	PRICE EACH	
					1	4+
H-10479	S-Hook	1" x 10'	Light duty trucks, trailers, loose loads	2,100	\$13	\$12
H-9714		1" x 15'			15	14
H-9715	E-Track	2" x 12'	E-Track fitting in trailers	3,000	23	21
H-9716		2" x 16'			25	23
H-9228	U-Hook	2" x 15'	Trailers with load rings	5,000	26	24
H-9229		2" x 27'			30	28

### WINCH STRAP

MODEL NO.	FITTING STYLE	SIZE W x L	RECOMMENDED USES	CAPACITY (LBS.)	1	4+
H-10480	Flat Hook	4" x 27'	Flatbeds with winches	15,000	\$34	\$32

## FLOOR JACKS

Easily lift vehicles, machinery and farm equipment.

- Low clearance design. Reach maximum height in seconds. 49" handle.
- Overload protection.
- Welded steel construction. Iron casters swivel for easy positioning.



Meets ASME and ANSI standards

MODEL NO.	CAPACITY	LIFTING HEIGHT		OVERALL LENGTH	WT. (LBS.)	PRICE EACH	
		MIN.	MAX.			1	2+
H-10467	2½ Tons	3¼"	20"	26"	69	\$265	\$250
H-10468	3½ Tons	4"	21"	27½"	94	335	320

■ SHIPS VIA MOTOR FREIGHT

## JACK STANDS

Support vehicles and heavy equipment.

- Large saddle and base for stability. Must use in pairs.
- Self-locking ratchet with locking pin for added safety.
- Powder-coated steel construction.



Meets ASME-PASE standards

MODEL NO.	CAPACITY	HEIGHT		BASE W x L	WT. (LBS.)	PRICE PER PAIR	
		MIN.	MAX.			1	2+
H-10465	3 Tons	11½"	16¾"	8 x 6"	14	\$70	\$65
H-10466	6 Tons	15½"	23¾"	11 x 10"	28	125	118

### HAMMER DRILL AND IMPACT DRIVER

Durable brushless motors deliver superior performance.

- Professional grade M18™ REDLITHIUM™ XC5.0 battery lasts 2x longer than standard lithium batteries.

**Hammer Drill** – Easily drill in wood, metal and concrete. 1/2" chuck. Includes stabilizing handle.

**Impact Driver** – Quickly drive in screws without stripping them. 1/4" hex chuck.

**Combo Set** – Includes hammer drill, impact driver, (2) M18™ batteries, battery charger and carrying case.

\* Tool only. Battery and charger sold separately.

MODEL NO.	DESCRIPTION	VOLTAGE	WT. (LBS.)	PRICE EACH	
				1	2+
H-10659*	Hammer Drill	18V	4	\$250	\$240
H-10660*	Impact Driver		3	195	185
H-10661	Combo Set		16	525	505



Milwaukee's most powerful hammer drill and impact driver for construction and maintenance crews.

### ANGLE GRINDER

Quickly grind down and cut off jagged metal edges and rusty bolts.

- 8,500 RPM brushless motor.
- Anti-vibration handle provides all-day comfort.
- Kickback protection for safety.



Tool only. Grinder Wheels available, see uline.com

MODEL NO.	DESCRIPTION	LENGTH	VOLTAGE	WT. (LBS.)	PRICE EACH	
					1	2+
H-10663	Grinder	13"	18V	4	\$250	\$240

### SAWZALL® RECIPROCATING SAW

Cut through metal conduit, wood beams and PVC pipe.

- Reliable brushless motor.
- Variable speed control. Up to 3,000 strokes per minute.
- LED light illuminates surface while cutting.



Tool only. Blades available, see uline.com

MODEL NO.	DESCRIPTION	LENGTH	VOLTAGE	WT. (LBS.)	PRICE EACH	
					1	2+
H-10667	Sawzall®	17"	18V	7	\$250	\$240

### M18™ REDLITHIUM™ BATTERY AND CHARGER

Instantly increase productivity with additional batteries for any job site.

MODEL NO.	DESCRIPTION	VOLTAGE	WT. (LBS.)	PRICE EACH	
				1	2+
H-10662	M18™ XC5.0 AH	18V	2	\$195	\$190
H-8855	M18™ Rapid Charger	12V/18V		115	110

- Charges most Milwaukee® batteries in under an hour.
- Indicator light displays remaining battery power.



H-10662

H-8855

### PACKOUT™ STORAGE SYSTEM New

Storage that works for you in the shop, on the road and at the job site.

- Easy-clip modular components provide the ultimate versatility.
- Impact-resistant body and metal latches withstand harsh conditions.
- Lid seals out dust and water. Padlockable for extra security.
- Handle extends to 44". • 9" all-terrain wheels. • IP65 rated.

3-Piece Kit Includes: (1) tool box, (1) large tool box and (1) rolling tool box.

6-Piece Kit Includes: (2) compact organizers, (1) organizer, (1) tool box, (1) large tool box and (1) rolling tool box.

Individual components, see uline.com

MODEL NO.	DESCRIPTION	OUTSIDE DIM. W x D x H	WT. (LBS.)	PRICE EACH	
				1	3+
H-10669	3-Piece Kit	22 x 19 x 33"	48	\$375	\$360
H-10670	6-Piece Kit	22 x 19 x 41"	59	530	505



6-PIECE KIT



3-PIECE KIT

SHIPS VIA UPS

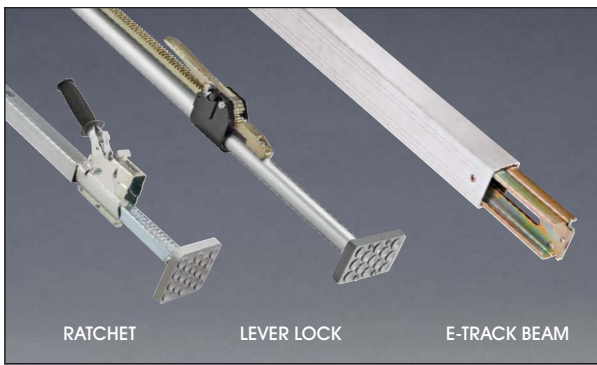

## LOAD BARS

Safely secure loads during transport.

- Fit between walls of trucks, trailers or railcars.
- Use in pairs for best results.



### RUBBER ENDS

MODEL NO.	STYLE	MATERIAL	ADJUSTABLE LENGTH	WT. (LBS.)	PRICE EACH	
					1	4+
H-1413	Ratchet	Steel	87-119"	14	\$58 any qty.	
H-8214	Lever Lock	Steel	89-104"	12	\$62	\$58
H-1798		Aluminum		9	\$63 any qty.	

**Ratchet:** Secure fit in your truck or trailer.

**Lever Lock:** Strong and durable. Locks easily into place.

**E-Track Beam:** Add levels to use vertical space. Snaps into trailer fittings.

### E-TRACK BEAM

MODEL NO.	WORKING LOAD LIMIT	MATERIAL	ADJUSTABLE LENGTH	WT. (LBS.)	PRICE EACH	
					1	4+
H-3690*	3,000 lbs.	Aluminum	85-96"	22	\$113	\$108
H-1600			92-102"	26	110	105

\* For straight or box trucks

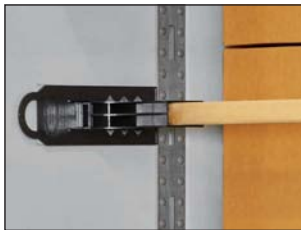

## LOGISTICK® LOAD BAR

Economical load bar for one-way use. Fits a standard 8-foot 2x4.

- Plastic pockets with adhesive backing secure to side of trailer.
- Use in standard-size trailers.
- Easy to install and remove from trailer.



Foam inserts keep 2x4 stable.

MODEL NO.	ADJUSTABLE LENGTH*	QTY./ CASE	PRICE PER CASE	
			1	4+
H-7890	99-102"	6 Pairs	\$90	\$87

\* Length based on 96" long 2x4, not included



## TOW STRAPS

Save the day! Pull cars, trucks and pontoon boats out of trouble.

- Strong polyester strap. Cut resistant and weatherproof.

- Forged steel hooks easily secure to vehicles for towing.



Sewn Eye available, see uline.com

MODEL NO.	FITTING STYLE	SIZE W x L	CAPACITY (LBS.)	PRICE EACH		
				1	4	24+
H-9674	Steel Hook	2" x 20"	9,000	\$25	\$23	\$20
H-9675		2" x 30"		30	28	25



## BUNGEE CORDS AND STRAPS

You can never have enough. Keep several in the truck, trailer and tool shed.

**Bungee Cords** – Hold down covers and light loads.

**Rubber Straps** – Heavy-duty EPDM withstands exposure to sun.

**Bungee Cord Rolls** – Cut to desired length and attach to hooks, sold separately.

MODEL NO.	DESCRIPTION	LENGTH	RECOMMENDED USES	QTY./ PACK	PRICE/PACK	
					1	2+
H-3600	Bungee Cord	18"	Secure trash cans, light loads	10	N/A	\$12
H-1417		24"			N/A	15
H-3344		36"			\$20	19
H-9668		48"			28	26

MODEL NO.	DESCRIPTION	LENGTH	RECOMMENDED USES	QTY./ PACK	PRICE/PACK	
					1	2+
H-3601	Rubber Tarp Strap	15"	Secure tarps and small cargo	10	\$17	\$16
H-3602		21"			19	18
H-3603		31"			25	23
H-9707		41"			34	32

MODEL NO.	DESCRIPTION	SIZE L x DIAM.	RECOMMENDED USES	QTY./ PACK	PRICE/PACK	
					1	2+
H-6614	Bungee Cord Roll	250' x 5/16"	Create custom sizes	1	\$85	\$80
H-6615		300' x 3/8"			120	110
H-6616	Bungee Hook	2 1/2"		10	N/A	12



# BEST® EXPANDABLE/PORTABLE CONVEYORS

Flexible, portable, go-anywhere conveyor for loading and unloading trucks or moving product.

- Recommended for packing, shipping/receiving and temporary assembly lines.
- Optimize floor space – Compacts for storage.
- Free-spinning steel skate wheels move products easily.
- Load capacity – 250 lbs. per linear foot.
- 5" swivel casters. Lockable end casters.

MODEL NO.	OVERALL WIDTH	ADJUSTABLE LENGTH	ADJUSTABLE HEIGHT	LEG SETS PER UNIT	WT. (LBS.)	PRICE EACH
H-1394	18"	2 - 8'	28½" - 41½"	3	169	\$1,005
H-1395	18"	3 - 12'		4	184	1,355
H-1396	18"	6 - 24'		7	397	2,450
H-1397	24"	6 - 24'		7	498	2,750
H-3859	24"	9 - 36'		11	757	4,105
H-3860	30"	6 - 24'		7	698	3,030

SHIPS ASSEMBLED VIA MOTOR FREIGHT



## ULINE EXPANDABLE CONVEYORS

Cost-effective conveyors for moving product out the door.

- Recommended for light-duty manufacturers and assembly lines.
- Collapsible for quick and easy storage.
- Durable plastic skate wheels provide exceptional spin.
- Load capacity – 200 lbs. per linear foot.
- 5" swivel casters. Lockable end casters.

MODEL NO.	OVERALL WIDTH	ADJUSTABLE LENGTH	ADJUSTABLE HEIGHT	LEG SETS PER UNIT	WT. (LBS.)	PRICE EACH
H-9669	18"	2 - 8'	28½" - 41½"	3	160	\$755
H-6873	18"	3 - 12'		4	175	995
H-6874	18"	6 - 24'		7	377	1,740
H-6875	24"	6 - 24'		7	473	1,955
H-6876	24"	9 - 36'		11	719	3,045
H-9218	30"	6 - 24'		7	665	2,275

SHIPS UNASSEMBLED VIA MOTOR FREIGHT



IN STOCK – SHIPS TODAY

## GRAVITY SKATE WHEEL CONVEYORS

Lightweight conveyors for product staging and temporary assembly lines. Easy setup and takedown.

- Free-spinning steel skate wheels quickly move product.
- Hook steel frames together for longer runs. 3" axle centers.
- Tripod stands are portable with easy height adjustment.



### CONVEYORS

\*Capacity based on evenly distributed live load

MODEL NO.	WIDTH		SECTION LENGTH	WHEELS/ FOOT	FRAME CAP.* (LBS.)	WT. (LBS.)	PRICE EACH	
	OVERALL	BTWN. FRAME					1	4+
H-4964	18"	16"	10'	16	350	83	\$530	\$510
H-4966	24"	22"		20			650	625

SHIPS VIA MOTOR FREIGHT

### TRIPOD STANDS

MODEL NO.	WIDTH	ADJUSTABLE HEIGHT	CAP. (LBS.)	WT. (LBS.)	PRICE EACH	
					1	4+
H-4967	18"	23 - 39"	350	11	\$120	\$115
H-4968	24"				12	\$120

SHIPS VIA UPS

# LIGHT DUTY GRAVITY ROLLER CONVEYORS



Roll lightweight packages through shipping lines and staging areas.

- Free-spinning gravity rollers improve packing speed.
- 3" roller centers.
- Connect steel frames together for longer runs.

1 $\frac{3}{8}$ " Diameter Rollers – For lightweight items.  
12-gauge steel frame.

Light Duty H-Stands – Support Light Duty Gravity Roller Conveyors.



H-4072

- Top mounting plates adjust for incline.
- Bottom footplate bolts into floor for permanent use.

## LIGHT DUTY – 1 $\frac{3}{8}$ " DIAMETER ROLLERS

MODEL NO.	WIDTH		SECTION LENGTH	FRAME CAP.* (LBS.)	WT. (LBS.)	PRICE EACH	
	OVERALL	BTWN. FRAME				1	4+
H-4068	12"	10"	5'	1,250	37	\$270	\$260
H-4069			10'	310	68	505	490
H-5012	18"	16"	5'	1,250	47	310	300
H-5013			10'	310	97	590	575
H-5014	24"	22"	5'	1,250	58	355	345
H-5015			10'	310	108	680	660

\*Capacity based on evenly distributed live load

SHIPS VIA MOTOR FREIGHT

## H-STANDS – FOR LIGHT DUTY GRAVITY ROLLER CONVEYORS

MODEL NO.	OVERALL WIDTH	ROLLER DIAM.	ADJUSTABLE HEIGHT	STAND CAP. (LBS.)	WT. (LBS.)	PRICE EACH	
						1	4+
H-4072	12"				18	\$120	\$115
H-5016	18"	1 $\frac{3}{8}$ "	24 - 36"	1,500	21	120	115
H-5017	24"				23	120	115

SHIPS VIA MOTOR FREIGHT

## REPLACEMENT ROLLERS

Replace worn or broken rollers.



### 1 $\frac{3}{8}$ " DIAMETER ROLLERS

Min. 2

MODEL NO.	AXLE DIAM.	BETWEEN FRAME WIDTH	PRICE EACH	
			2	10+
H-4074	1/4" Round	10"	\$14	\$13
H-5018		16"	18	17
H-5019		22"	20	19

SHIPS VIA UPS

## FIXED END STOPS

Hold packages at the end of the run.



- Use with Light Duty and Heavy Duty Gravity Roller Conveyors.

MODEL NO.	OVERALL WIDTH	WT. (LBS.)	PRICE EACH	
			1	4+
H-6384	18"	2	\$47	\$45
H-6385	24"		52	50
H-6386	30"		62	60

SHIPS VIA UPS

## SIDE RAILS

Keep packages from falling off the line.



- Use with Light Duty and Heavy Duty Gravity Roller Conveyors.

MODEL NO.	OVERALL LENGTH	OVERALL HEIGHT	WT. (LBS.)	PRICE EACH	
				2	4+
H-6906	5'	2"	7	\$52	\$49

Sold in multiples of 2

SHIPS VIA UPS

# EXTRA WIDE GRAVITY ROLLER CONVEYORS

## HIGH CAPACITY



Move heavy pallets and extra-wide containers in staging and assembly areas.

- Super heavy duty 4-gauge steel frame.
- Free-spinning steel rollers improve packing speed.
- Connect steel frames together for longer runs.
- 3" roller centers.

H-Stand – Supports Extra Wide Gravity Roller Conveyors.



H-8824

## 2 $\frac{1}{2}$ " DIAMETER ROLLERS

MODEL NO.	WIDTH		SECTION LENGTH	FRAME CAP.* (LBS.)	WT. (LBS.)	PRICE EACH	
	OVERALL	BTWN. FRAME				1	2+
H-8822	54"	51"	5'	8,100	495	\$1,505	\$1,440
H-8823			10'	2,880	980	2,905	2,770

\*Capacity based on evenly distributed live load

SHIPS VIA MOTOR FREIGHT

## H-STAND

MODEL NO.	OVERALL WIDTH	ROLLER DIAM.	ADJUSTABLE HEIGHT	STAND CAP. (LBS.)	WT. (LBS.)	PRICE EACH	
						1	4+
H-8824	54"	2 $\frac{1}{2}$ "	20 - 26"	4,000	34	\$205	\$195

SHIPS VIA MOTOR FREIGHT

# HEAVY DUTY GRAVITY ROLLER CONVEYORS

Move heavy packages or containers through packing lines and assembly areas.

- Free-spinning gravity rollers improve packing speed.
- 3" roller centers.
- Connect steel frames together for longer runs.

1.9" Diameter Rollers – For heavy, bulky items.  
10-gauge steel frame.

Heavy Duty H-Stands – Support Heavy Duty Gravity Roller Conveyors.



- Top mounting plates adjust for incline.
- Bottom footplate bolts into floor for permanent use.



## H-STANDS – FOR HEAVY DUTY GRAVITY ROLLER CONVEYORS

MODEL NO.	WIDTH		ROLLER DIAM.	ADJUSTABLE HEIGHT	STAND CAP. (LBS.)	WT. (LBS.)	PRICE EACH	
	OVERALL	BTWN. FRAME					1	4+
H-3413	18"	15"	1.9"	24 - 36"	1,500	21	\$120	\$115
H-3414	24"	15"				23	120	115
H-4073	30"	15"				26	120	115
H-6904	36"	15"				29	120	115

SHIPS VIA MOTOR FREIGHT

## HEAVY DUTY – 1.9" DIAMETER ROLLERS

MODEL NO.	WIDTH		SECTION LENGTH	FRAME CAP.* (LBS.)	WT. (LBS.)	PRICE EACH	
	OVERALL	BTWN. FRAME				1	4+
H-3409	18"	15"	5'	3,100	86	\$365	\$355
H-3411			10'	1,180	166	665	640
H-3410	24"	21"	5'	3,100	108	415	400
H-3412			10'	1,180	205	755	730
H-4070	30"	27"	5'	3,100	133	510	490
H-4071			10'	1,180	255	910	875
H-6902	36"	33"	5'	3,100	161	565	540
H-6903			10'	1,180	316	1,075	1,025

\*Capacity based on evenly distributed live load

SHIPS VIA MOTOR FREIGHT

## 90° CURVED CONVEYORS

Directs product flow to workstations and around obstructions.

- Free-spinning galvanized gravity rollers.

### 1.9" DIAMETER ROLLERS

MODEL NO.	WIDTH		INSIDE RADIUS	FRAME CAP.* (LBS.)	WT. (LBS.)	PRICE EACH	
	OVERALL	BTWN. FRAME				1	4+
H-6381	18"	15"	32½"	310	112	\$970	\$930
H-6382	24"	21"			145	1,095	1,050
H-6383	30"	27"			173	1,245	1,190

\*Capacity based on evenly distributed live load

SHIPS VIA MOTOR FREIGHT

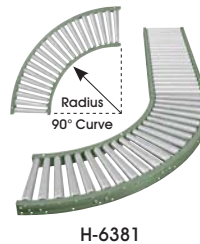

H-6381

## REPLACEMENT ROLLERS

Replace worn or broken rollers.



### 1.9" DIAMETER ROLLERS

Min. 2

MODEL NO.	AXLE DIAM.	BETWEEN FRAME WIDTH	PRICE EACH	
			2	10+
H-6637	7/16" Hex	15"	\$27	\$26
H-6638		21"	36	35
H-4075		27"	42	40

SHIPS VIA UPS

## CONVEYOR GATES

Provide temporary access through a conveyor line.

- Powder-coated steel frame.
- Spring hinge for easy opening.



MODEL NO.	WIDTH		SECTION LENGTH	FRAME CAP.* (LBS.)	WT. (LBS.)	PRICE EACH	
	OVERALL	BTWN. FRAME				1	2+
H-6907	18"	15"	3'	3,100	99	\$1,115	\$1,055
H-6908	24"	21"			124	1,175	1,120
H-6909	30"	27"			149	1,240	1,180

\*Capacity based on evenly distributed live load

SHIPS VIA MOTOR FREIGHT

## BALL TRANSFER TABLES

Rotate products easily for quick positioning or inspection.

- Used at conveyor intersections and production line stations.
- 10-gauge frame. 1" diameter steel balls set 1/4" high.
- 3" ball centers.



For complete line, see [uline.com](http://uline.com)

MODEL NO.	WIDTH		SECTION LENGTH	FRAME CAP.* (LBS.)	WT. (LBS.)	PRICE EACH	
	OVERALL	BTWN. FRAME				1	2+
H-5581	18"	15"	3'	1,140	62	\$510	\$485
H-5583	24"	21"			79	725	690
H-5585	30"	27"			96	930	885

\*Capacity based on evenly distributed live load

SHIPS VIA MOTOR FREIGHT



# STEEL DOCK BOARDS

FORKLIFT USE

Built to handle your heaviest traffic in loading and unloading trucks.



- Forklift maneuverability: loops flip up for easy forklift access.
- Steel pins safely anchor board between dock and truck.
- Nonslip diamond plate surface; side curbs stop runoffs.
- Heavy-duty all-welded steel construction.
- Additional sizes available, see [uline.com](http://uline.com)

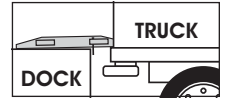

Drop ships in 2 days from TX

MODEL NO.	OVERALL SIZE* W x L	CAPACITY** (LBS.)	WT. (LBS.)	HEIGHT DIFFERENTIAL***	PRICE EACH
H-1828	60 x 48"	15,000	430	7"	\$1,455
H-1829	60 x 60"		540	9"	1,700
H-1830	60 x 72"		625	11"	1,950
H-3335	72 x 48"		495	7"	1,625
H-1831	72 x 60"		625	9"	1,835
H-2113	72 x 72"		720	11"	2,230
H-3604	72 x 84"		801	13"	2,505
H-2724	72 x 96"		899	15"	2,790
H-4783	84 x 60"		686	9"	2,210
H-3336	84 x 72"		823	11"	2,535

PLEASE ADD 5,000 LBS. TO THE BOARD CAPACITY WHEN USING 3-WHEEL FORKLIFTS OR TRUCKS USING A PAPER ROLL CLAMP.

MODEL NO.	OVERALL SIZE* W x L	CAPACITY** (LBS.)	WT. (LBS.)	HEIGHT DIFFERENTIAL***	PRICE EACH
H-3337	72 x 48"	20,000	585	7"	\$1,820
H-2728	72 x 60"		698	9"	2,210
H-2729	72 x 72"		812	11"	2,535
H-2730	72 x 96"		1,022	15"	3,190
H-4784	84 x 60"		775	9"	2,470
H-3338	84 x 72"		1,006	11"	2,830
H-6361	72 x 48"	25,000	690	7"	2,040
H-6362	72 x 60"		834	9"	2,435
H-6363	72 x 72"		978	11"	2,795
H-6364	84 x 72"		1,120	11"	3,140

\* Usable width about 6" less than overall width. \*\* Capacity = Triple the capacity of your forklift. \*\*\* Vertical distance between dock floor and truck bed.

# FORK EXTENSIONS



Stretch your forklift's reach with these handy slip-on extensions.

- Heavy-duty welded steel construction, slides easily onto existing forks.
- Fits forks up to 2" thick.
- OSHA requires fork extension length to be no longer than 150% of the length of supporting truck forks.

Fork Extension Rack, see page 486



Fork Covers available, see [uline.com](http://uline.com)

MODEL NO.	FITS FORK WIDTH	EXTENSION LENGTH	WT. (LBS.)	PRICE PER PAIR	
				1	2+
H-1501	4"	60"	71	\$245	\$235
H-1502		72"	84	265	255
H-3606		84"	120	330	320
H-2114		96"	130	395	380
H-2399	5"	60"	77	280	270
H-1503		72"	93	305	295
H-3607		84"	135	370	360
H-2115		96"	145	425	410
H-2116	6"	72"	95	320	310
H-3608		84"	158	440	425
H-2731		96"	168	540	515

SHIPS VIA MOTOR FREIGHT

# TRAILER JACKS

Safe, secure support for trailers when loading and unloading.



- High visibility yellow.
- Rugged welded steel.

H-2117 – Reversible ratchet for easy height adjustment.

H-2732 – Supporting beam safely distributes load. Reversible ratchet adjustment.

SHIPS VIA MOTOR FREIGHT

MODEL NO.	STATIC CAPACITY (LBS.)	LIFT CAPACITY (LBS.)	ADJUSTABLE HEIGHT	WT. (LBS.)	PRICE EACH	
					1	4+
H-1544	50,000	5,000	44-51"	35	\$145	\$140
■H-1545*	100,000	40,000	41-50"	116	325	315
■H-2117*	100,000	40,000	39-51"	126	375	360
■H-2732*	100,000	40,000	39½-51"	172	495	475

\* 10" SOLID RUBBER WHEELS

# DOCK PLATES

HAND OR PALLET TRUCK USE

Safely bridge the gap between your dock and trucks or trailers.

- Gradual 11° bend keeps edges flush with dock.
- Aluminum diamond dock plate is skid resistant in all kinds of weather.
- Safety legs secure plate between dock and trailer.
- Portable. Hand holes for easy moving.

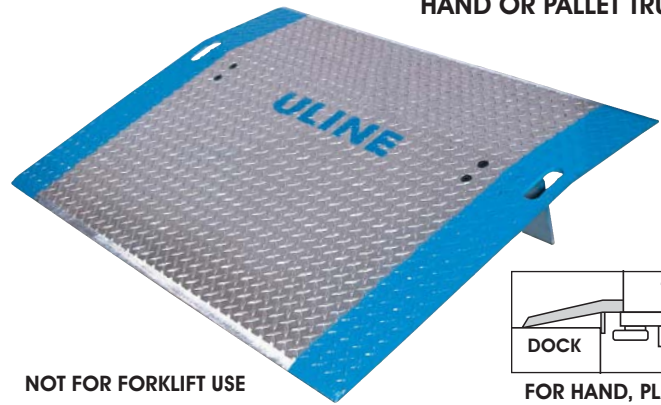

NOT FOR FORKLIFT USE

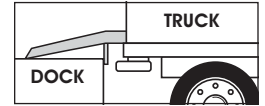

FOR HAND, PLATFORM OR PALLET TRUCKS ONLY.

MODEL NO.	OVERALL SIZE W x L	CAPACITY* (LBS.)	WT. (LBS.)	HEIGHT DIFFERENTIAL**	PRICE EACH
H-1832	36 x 24"	4,720	47	1"	\$285
H-2742	36 x 30"	3,913	55	2"	345
H-1285	36 x 36"	3,238	63	3"	395
H-1833	36 x 48"	1,764	79	5"	515
H-2743	48 x 24"	6,210	58	1"	375

\* Capacity = Combined weight of your maximum pallet load and hand truck

Drop ships in 2 days from TX

MODEL NO.	OVERALL SIZE W x L	CAPACITY* (LBS.)	WT. (LBS.)	HEIGHT DIFFERENTIAL**	PRICE EACH
H-1215	48 x 36"	4,383	79	3"	\$490
H-1216	48 x 48"	2,388	99	5"	600
H-1539	48 x 60"	1,656	118	7"	760
H-1540	60 x 36"	5,297	87	3"	620
H-1286	60 x 48"	3,158	114	5"	730

\*\* Vertical distance between dock floor and truck bed

# DOCK BOARDS

FORKLIFT USE

High-capacity bridge between dock and trailer.

- Bolted steel curbs prevent runoffs and add strength.
- Aluminum diamond plate surface gives nonslip traction.
- Gradual 11° bend keeps edges flush with dock and trailer.
- Safety legs keep dock board in place.
- 72" Extra-Wide – Unload a full trailer without repositioning dock board.

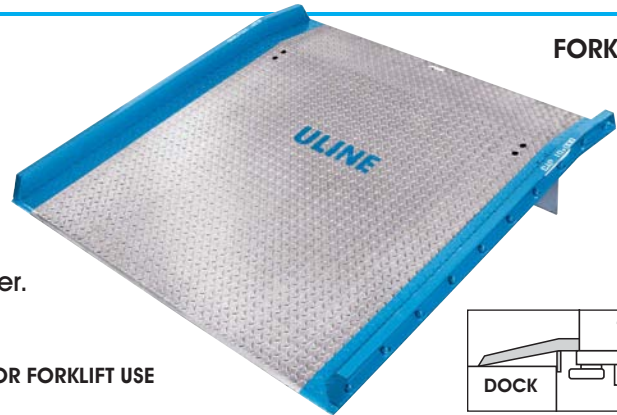

FOR FORKLIFT USE

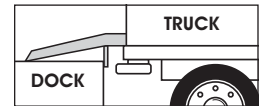

Drop ships in 2 days from TX

MODEL NO.	OVERALL SIZE* W x L	CAPACITY** (LBS.)	WT. (LBS.)	HEIGHT DIFFERENTIAL***	PRICE EACH
H-2744	54 x 48"	10,000	154	7"	\$980
H-1443	60 x 36"		127	5"	800
H-1288	60 x 48"		165	7"	1,020
H-1290	60 x 60"		202	9"	1,250
H-1506	60 x 72"		240	11"	1,505
H-1834	72 x 36"		144	5"	885
H-1836	72 x 48"		187	7"	1,140
H-1838	72 x 60"		230	9"	1,400

\* Usable width about 3" less than overall width

\*\* Capacity = Triple the capacity of your forklift

PLEASE ADD 5,000 LBS. TO THE BOARD CAPACITY WHEN USING 3-WHEEL FORKLIFTS OR TRUCKS USING A PAPER ROLL CLAMP.

MODEL NO.	OVERALL SIZE* W x L	CAPACITY** (LBS.)	WT. (LBS.)	HEIGHT DIFFERENTIAL***	PRICE EACH
H-2745	54 x 48"	15,000	186	7"	\$1,250
H-1444	60 x 36"		154	5"	995
H-1289	60 x 48"		201	7"	1,275
H-1291	60 x 60"		247	9"	1,535
H-1507	60 x 72"		294	11"	1,820
H-1835	72 x 36"		177	5"	1,090
H-1837	72 x 48"		230	7"	1,425
H-1839	72 x 60"		284	9"	1,765

\*\*\* Vertical distance between dock floor and truck bed

# DOCK BUMPERS

\* Width is the horizontal distance between bolt holes

MODEL NO.	SIZE* W x D x H	WT. (LBS.)	PRICE EACH	
			2	4+
H-2054	11 x 4 x 20"	42	\$105	\$100
H-1504	12 x 4 x 10"	25	60	57
H-5502	12 x 6 x 10"	29	90	85
H-1505	24 x 4 x 10"	45	105	100

Protect your dock from damage.

- Absorb impact from large, heavy vehicles.
- Super-tough truck tire material.
- H-2054 – Vertical bumper.
- Easy to install.

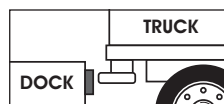

H-1504

# FLAMMABLE STORAGE CABINETS

**IN STOCK – SHIPS TODAY**



## SPACE SAVERS FOR YOUR SHOP

Organize and safely store flammable liquids and aerosols in your auto or machine shop.

- Double wall 18-gauge steel.
- 350 lb. shelf capacity. Adjustable shelves.
- Sloped shelves safely direct spills away from containers.
- Meets NFPA, IFC and OSHA standards.

**Yellow Safety Cabinets** – For aerosols, gasoline and flammable liquids.

**Red Safety Cabinets** – For paint, inks and Class III combustibles.

**Self-Closing Models** – Doors automatically close if temperature reaches 165°F.

**Mini** – Small and portable. Three bungee cords secure contents during transport.

**Countertop** – Convenient workstation storage for everyday essentials.

**Stackable** – Stack on top of 30 or 45-gallon cabinets. FM approved.

**Wall-Mount** – Store small containers at eye level for easy access. FM approved.

**Undercounter** – Fits easily under workbenches with 35" clearance. FM approved.

### 10 YEAR WARRANTY

SPECIFY COLOR: Red or Yellow

### ADDITIONAL SHELVES

MODEL NO.	DESCRIPTION	OUTSIDE DIMENSIONS W x D x H	CAPACITY (GAL.)	NO. OF SHELVES	WEIGHT (LBS.)	MANUAL		SELF-CLOSING		MODEL NO.	PRICE EACH
						1	2+	1	2+		
H-4174	Mini	17 x 8 x 22"	—	1	43	\$625	\$615	N/A	N/A	N/A	N/A
H-2569	Countertop	17 x 17 x 22"	4	1	60	665	655	\$760	\$745	N/A	N/A
■H-4175	Stackable	43 x 18 x 18"	12	0	129	850	835	905	885	N/A	N/A
■H-4176	Wall-Mount	43 x 12 x 44"	20	3	205	1,195	1,170	N/A	N/A	H-4176-ADD	\$69
■H-4177	Undercounter	35 x 22 x 35"	22	1	190	1,120	1,090	1,180	1,145	H-4177-ADD	76

■ SHIPS ASSEMBLED VIA MOTOR FREIGHT

# CORROSIVE CABINETS



STEEL  
10 YEAR WARRANTY

Protect your workplace from dangerous corrosives and acids.

- Adjustable shelves.
- Internal sump. Vents with caps.

**Steel** – Double wall 18-gauge steel. Keyed lock.

- Sloped shelves include poly trays.
- **Self-Closing** – Doors automatically close at 165°F.

**Poly** – 100% HDPE construction. No metal parts to rust.

- Padlockable. Padlocks, see pages 514-515.



POLY

\* Meets NFPA, IFC and OSHA Standards. FM Approved.

EASY ASSEMBLY. SHIPS VIA UPS.

### ADDITIONAL SHELVES

MODEL NO.	DESCRIPTION	OUTSIDE DIMENSIONS W x D x H	CAPACITY (GAL.)	NO. OF SHELVES	WEIGHT (LBS.)	MANUAL		SELF-CLOSING		MODEL NO.	PRICE EACH
						1	2+	1	2+		
■H-3775*	Steel	43 x 18 x 44"	30	1	225	\$1,235	\$1,195	\$1,380	\$1,340	H-1563-ADD	\$80
■H-3776*		43 x 18 x 65"	45	2	303	1,495	1,450	1,650	1,595		
H-5659	Poly	18 x 18 x 22"	4	2	32	320	310	N/A	N/A	N/A	N/A
H-5660		36 x 23 x 36"	24	2	96	825	805	N/A	N/A		

■ SHIPS ASSEMBLED VIA MOTOR FREIGHT



# FLAMMABLE STORAGE CABINETS



H-1563



H-1563



H-1564

Ensure safety and provide storage for your flammable or combustible liquids.

- Double wall 18-gauge steel.
- 350 lb. shelf capacity. Adjustable shelves.
- Sloped shelves safely direct spills away from containers.
- Recessed paddle handle, can be used with padlock.
- Continuous piano hinge provides smooth closure.
- Adjustable leveling feet for uneven surfaces.
- Meets NFPA, IFC and OSHA standards.

**Yellow Safety Cabinets** – For aerosols, gasoline and flammable liquids.

**Red Safety Cabinets** – For paint, inks and Class III combustibles.

**Self-Closing Models** – Doors automatically close if temperature reaches 165°F.

**Slimline Cabinets** – Use in narrow spaces.

## 10 YEAR WARRANTY

SPECIFY COLOR: Red or Yellow

## ADDITIONAL SHELVES

MODEL NO.	DESCRIPTION	OUTSIDE DIMENSIONS W x D x H	CAPACITY (GAL.)	NO. OF SHELVES	WEIGHT (LBS.)	MANUAL		SELF-CLOSING		MODEL NO.	PRICE EACH
						1	2+	1	2+		
H-2218	Slimline	23¼ x 18 x 35"	12	1	122	\$840	\$825	\$885	\$870	H-2570-ADD	\$64
H-2570		23¼ x 18 x 65"	22	3	199	1,190	1,165	1,320	1,290	H-2570-ADD	64
H-1563	Standard	43 x 18 x 44"	30	1	216	1,080	1,055	1,230	1,195	H-1563-ADD	80
H-1564		43 x 18 x 65"	45	2	291	1,260	1,230	1,425	1,390	H-1563-ADD	80
H-1565		34 x 34 x 65"	60	2	367	1,535	1,495	1,720	1,690	H-1565-ADD	130
H-2219*		43 x 34 x 65"	90	2	423	2,005	1,965	2,090	2,050	H-2219-ADD	165
H-4837	Dolly for 30 and 45-Gallon (43 x 18") 				32	1 / \$105 each		2+ / \$100 each			

\* OSHA code 29 CFR 1910.106 states that no more than 60 gallons may be Class I, Class II or Class III liquids

SHIPS ASSEMBLED VIA MOTOR FREIGHT

# FLAMMABLE DRUM STORAGE



HORIZONTAL

Keep drums safe and secure. For gasoline and flammable liquids.

- **Self-Closing Models** – Doors automatically close if temperature reaches 165°F.
- Meets NFPA, IFC and OSHA standards. 10 year warranty.

**Horizontal** – Allows gravity dispensing from 55-gallon drum. Drum cradle included, rolls on guide rails.

**Vertical** – Holds 30 to 55-gallon drums. Adjustable shelf. Steel rollers for easy loading and unloading.



VERTICAL

MODEL NO.	DESCRIPTION	OUTSIDE DIMENSIONS W x D x H	CAPACITY (GAL.)	WEIGHT (LBS.)	MANUAL		SELF-CLOSING	
					1	2+	1	2+
H-5705	Horizontal	30 x 48 x 50"	55	392	\$1,935	\$1,880	\$2,085	\$2,030
H-3685	Vertical	34 x 34 x 65"	55	398	1,865	1,810	2,030	1,975
H-3686*		59 x 34 x 65"	110	622	3,525	3,450	3,975	3,900

\* OSHA code 29 CFR 1910.106 states that no more than 60 gallons may be Class I, Class II or Class III liquids

SHIPS ASSEMBLED VIA MOTOR FREIGHT

For complete information, see [uline.com](http://uline.com)

# FIRE EXTINGUISHERS AND ACCESSORIES

Easy to order and cost efficient, so you are always prepared.

## CLASS ABC

- Steel cylinder contains monoammonium phosphate dry chemical.
- Smother wood, plastic, liquid and electrical fires.
- Rechargeable.
- Mounting bracket included.

**S-24178** – Powerful "knock down" blast. Rapid discharge for high-risk areas, including offices, hotels and banks.



FAST FLOW  
S-24178

MODEL NO.	CAPACITY	UL RATING	SIZE W x D x H	DIAM.	PRICE EACH	
					1	3+
S-9872	2½ lbs.	1A:10B:C	6 x 4 x 16"	3"	\$63	\$60
S-9873	5 lbs.	2A:10B:C	8 x 5 x 16"	4¼"	70	67
S-22291	5 lbs.	3A:40B:C	8 x 5 x 16"	4¼"	74	70
S-9874	10 lbs.	4A:80B:C	8 x 5 x 21"	5"	108	105
S-14434	20 lbs.	10A:120B:C	10 x 7 x 23"	7"	188	181
S-24178	30 lbs.	4A:40B:C	11 x 8 x 25"	8"	595	565

Class K and Carbon Dioxide Extinguishers, see uline.com



S-9874

S-9872



## SIGN

Keep your workplace safe and clean.

- For indoor/outdoor use.
- Tough, 4 mil thick vinyl with adhesive backing.



## PROJECTING SIGN

Locate fire extinguishers immediately.

- 3-way sign is easily visible from front and sides.
- "V" shape projects 45° from wall.



## TAGS

Attach, record and track inspections.

- Heavy-duty 15 mil vinyl. 3/8" metal eyelet.
- Cable ties included.

Sold in packs of 25

MODEL NO.	SIZE H x W	PRICE EACH		
		1	3	5+
S-14801V	18 x 4"	\$10	\$9	\$8

MODEL NO.	SIZE H x W x D	PRICE EACH		
		1	3	5+
S-19260	18 x 8 x 3"	\$31	\$29	\$27

MODEL NO.	SIZE	PRICE PER PACK	
		1	3+
S-15615	5¼ x 3⅝"	\$44	\$40

## BRACKETS

Mount extinguishers right where you need them.

- Vehicle or wall-mountable.
- For work trucks, boats and planes.
- Powder-coated steel construction.



Additional sizes, see uline.com

MODEL NO.	FOR EXT. CAP.	SIZE W x D x H	WT. (LBS.)	PRICE EACH	
				1	3+
H-5937	10 lbs.	8 x 7 x 11"	4	\$60	\$55
H-5938	20 lbs.	10 x 8 x 13"	7	70	65

## STAND

Portable stand keeps fire protection close at hand.

- For large, open areas and temporary job sites.
- Polyethylene stand holds 5-20 lb. extinguishers.



Fire extinguisher not included. OSHA Compliant.

MODEL NO.	SIZE W x D x H	WT. (LBS.)	PRICE EACH	
			1	3+
H-5801	22 x 22 x 34"	14	\$147	\$137

## OUTDOOR CABINETS

For outdoor, humid and corrosive environments.

- High-impact polystyrene will not rust or fade.
- Plexiglass breaks cleanly with breaker bar.
- Surface mount.



Fire extinguisher not included

MODEL NO.	MAX. EXT. CAP.	INSIDE DIM. W x D x H	WT. (LBS.)	PRICE EACH	
				1	3+
H-7268	2½-5 lbs.	6 x 5 x 17"	3	\$54	\$52
H-7269	10 lbs.	7 x 6 x 20"	4	63	61

# FIRE EXTINGUISHER CABINETS

Attractive steel cabinet minimizes the fire extinguisher look. Reusable.

- Convenient pull handle with plexiglass window. Clean, white enamel finish.

**Surface Mount** – Easy installation. Pick a spot and hang. Sticks out 6" from wall.

**Semi-Recessed** – More streamlined look. Sticks out 3" from wall.



Stainless Steel, see uline.com



## SURFACE MOUNT

Mounting hardware not included

MODEL NO.	MAX. EXTINGUISHER CAPACITY	INSIDE DIM. W x D x H	WT. (LBS.)	PRICE EACH	
				1	3+
H-4871	2½-5 lbs.	8 x 6 x 18"	8	\$80	\$78
H-4872	10 lbs.	9 x 6 x 24"	10	95	92

## SEMI-RECESSED

H-5799	2½-5 lbs.	9 x 5 x 18"	12	\$120	\$115
H-5800	10 lbs.	11 x 6 x 24"	18	130	125

# GAS CYLINDER CABINETS

Prevent rolling and tipping of flammable gas cylinders.

- Secure all-welded or bolted steel design.
- 14-gauge solid steel top. Heavy-duty steel mesh sides.
- Foot pads have holes for mounting to floor.
- Flammable signage. • Hasp for padlock.
- Meets OSHA 1910 standards.

**Cabinets** – Slotted or solid shelves hold 20, 33 and 40 lb. liquid propane cylinders.

**Lockers** – Open bottom. Hold compressed gas cylinders up to 200 lbs. or 65" tall. Includes safety chain.

**Combo Cabinet/Locker** – Store 8 cylinders on horizontal slotted shelves and 10 cylinders in open-bottom vertical locker.



H-5656



H-2572



H-2736



H-8677



H-7009

## ASSEMBLED

Aluminum Cabinets, see [uline.com](http://uline.com)

MODEL NO.	DESCRIPTION	CYLINDER CAPACITY	NO. OF SHELVES	OUTSIDE DIMENSIONS W x D x H	WT. (LBS.)	PRICE EACH	
						1	2+
H-2736	Vertical Cabinets	2	1	32 x 21 x 40"	91	\$595	\$580
H-2573		4	1	32 x 40 x 40"	119	760	740
H-2574		8	2	32 x 40 x 71"	197	1,095	1,065
H-3119		12	2	49 x 40 x 71"	291	1,505	1,460
H-2571	Horizontal Cabinets	4	2	32 x 40 x 40"	138	825	800
H-8676		6	3	32 x 40 x 55"	185	1,075	1,045
H-2572		8	4	32 x 40 x 71"	229	1,225	1,190
H-3118		12	4	49 x 40 x 71"	323	1,595	1,550
H-10739		16	4	62 x 40 x 71"	430	2,360	2,300
H-5656	Vertical Lockers	10	–	32 x 40 x 71"	188	1,050	1,025
H-5657		20	–	62 x 40 x 71"	332	1,800	1,750
H-8677	Combo Cabinet/Locker	8/10	4	62 x 40 x 71"	380	2,040	1,985

SHIPS ASSEMBLED VIA MOTOR FREIGHT

## UNASSEMBLED

MODEL NO.	DESCRIPTION	CYLINDER CAPACITY	NO. OF SHELVES	OUTSIDE DIMENSIONS W x D x H	WT. (LBS.)	PRICE EACH	
						1	2+
H-7617	Vertical Cabinets	2	1	32 x 21 x 40"	95	\$380	\$365
H-7008		4	1	32 x 41 x 40"	136	475	455
H-7009	Horizontal Cabinets	4	2	32 x 41 x 40"	157	485	465
H-7010		8	4	32 x 41 x 71"	237	730	710
H-7011	Vertical Locker	10	–	32 x 41 x 71"	166	655	635

SHIPS UNASSEMBLED VIA MOTOR FREIGHT

# OILY WASTE CANS

SPECIFY COLOR: Red or Yellow

MODEL NO.	DIMENSIONS DIAM. x H	CAPACITY (GALLONS)	WEIGHT (LBS.)	PRICE EACH	
				1	3+
H-1846	12 x 16"	6	10	\$90	\$85
H-1847	14 x 18"	10	12	103	97
H-2737	16 x 20"	14	16	126	119
H-2738	18 x 24"	21	22	185	175

OSHA Compliant. UL Listed. FM Approved.

Safe, secure disposal for oily and solvent-soaked rags.

- Prevents fires due to spontaneous combustion.
- Hands-free; foot pedal opens lid.
- Lead-free galvanized steel.





# GAS CANS



TYPE I

**Type I** – Easy to fill, easy to pour gas cans designed for maximum safety.

**Type II** – 2 spouts allow ventilation for smooth pouring. Flexible metal hose.

- Gasoline
- Diesel
- Kerosene
- Oil



TYPE II

**TYPE I** SPECIFY COLOR: Red, Yellow, Blue or Green

MODEL NO.	STYLE	CAPACITY (GALLONS)	WEIGHT (LBS.)	PRICE EACH	
				1	3+
H-1848	Type I	2	5	\$56	\$53
H-1850		5	6	61	58
H-4873	Funnel for Type I Gas Cans		1	8	7

OSHA and NFPA Code 30 Compliant. UL/C-UL Listed and FM Approved.

**TYPE II** SPECIFY COLOR: Red, Yellow, Blue or Green

MODEL NO.	STYLE	CAPACITY (GALLONS)	WEIGHT (LBS.)	PRICE EACH	
				1	3+
H-1849	Type II	2	7	\$116	\$108
H-1851		5	8	121	113

OSHA and NFPA Code 30 Compliant. UL/C-UL Listed and FM Approved.



## LEAK DIVERTERS

Divert overhead leaks away from property, machinery and inventory.

- Puncture and chemical-resistant HDPE. Sewn-in brass grommets.
- Lightweight, UV-resistant tarp. Works like a funnel.
- Connects to standard 3/4" hose.

SPECIFY COLOR: Yellow or White

MODEL NO.	DESCRIPTION	SIZE	MIL	WEIGHT (LBS.)	PRICE EACH	
					1	3+
H-5743	Deluxe	3 x 3'		2	\$48	\$45
H-5744		5 x 5'	20	4	67	63
H-5745		10 x 10'		11	155	145

## DRAIN SEALS

Keep out leaks and spills headed for your drains.

- Flexible gel-like material delivers a durable seal.
- Reversible, washable and reusable.
- Cuts easily to size.
- Thick, reinforced inner mesh resists rips and tears.



MODEL NO.	DESCRIPTION	SIZE	THICKNESS	WEIGHT (LBS.)	PRICE EACH	
					1	3+
H-8681	Drain Seal	24 x 24"	3/8"	6	\$165	\$155
H-8682		36 x 36"			335	320

Meets EPA, SPCC and NPDES Regulations

# GAS CYLINDER STORAGE

## RACKS

Safely store gas cylinders.

- 11-gauge, 2" square steel tubing. Powder-coat finish.
- Chains secure cylinders up to 12" in diameter.
- Bolt to floor for extra stability.



H-9679

### 2-DEEP RACKS

Meets NFPA and OSHA Standards

MODEL NO.	CYLINDER CAPACITY	OUTSIDE DIM. W x D x H	WEIGHT (LBS.)	PRICE EACH	
				1	2+
H-9678	2	16 x 26 x 30"	72	\$475	\$450
H-9679	4	30 x 26 x 30"	113	650	620
H-9680	6	44 x 26 x 30"	153	825	790

Mounting hardware included

EASY ASSEMBLY. SHIPS VIA UPS.

## WALL BRACKETS

Easy-to-use tank storage.

- Polyester straps with steel buckles hold tanks in place.
- Cushioned bumper guards for scratchless grip.
- Fits 4-12" diam. cylinders.



### WALL BRACKETS

Meets NFPA and OSHA Standards

MODEL NO.	CYLINDER CAPACITY	DIMENSIONS L x D x H	WEIGHT (LBS.)	PRICE EACH	
				1	3+
H-10676	1	8 x 2 x 4"	4	\$35	\$32
H-10677	2	24 x 2 x 4"	7	67	62
H-10678	3	36 x 2 x 4"	10	90	85

Mounting hardware not included

SHIPS VIA UPS

# OUTDOOR SAFETY CABINETS

1 YEAR WARRANTY



H-8710

Weatherproof storage to keep aerosols, gasoline and flammable liquids safe.

- Double wall 18-gauge steel with stainless steel 3-point locking system.
- Durable weather and UV-resistant urethane finish. • Forkliftable.
- Sloped roof with 2<sup>3</sup>/<sub>4</sub>" overhang sheds rain and snow.

**Self-Closing** – Doors automatically close if temperature reaches 165°F.



H-8711

\* OSHA code 29 CFR 1910.106 states that no more than 60 gallons may be Class I, Class II or Class III liquids

MODEL NO.	OUTSIDE DIMENSIONS W x D x H	CAPACITY (GAL.)	NO. OF SHELVES	WEIGHT (LBS.)	MANUAL		SELF-CLOSING	
					1	2+	1	2+
H-8710	43 x 18 x 50"	30	1	292	\$1,755	\$1,705	\$2,075	\$2,025
H-8711	43 x 18 x 71"	45	2	382	2,000	1,950	2,325	2,275
H-10737*	43 x 31 x 71"	90	2	532	3,250	3,200	3,575	3,525

Meets NFPA, OSHA and FM Standards

SHIPS ASSEMBLED VIA MOTOR FREIGHT



## STEEL SALVAGE DRUM

Transport 55 gallon drums that no one else wants to touch.

- Heavy duty, 19-gauge steel for maximum protection. • Open top removable lid.
- Bolt ring and gasket lid provides tight seal.
- Multilingual salvage logo.

Meets DOT 49 CFR 173.3

MODEL NO.	INSIDE DIM. DIAM. x H	CAP. (GAL.)	UN RATING	WT. (LBS.)	PRICE EACH	
					1	3+
H-8718	26 x 37"	85	1A2/X440/S	63	\$305	\$295

SHIPS VIA MOTOR FREIGHT

## SPILL DIKES



Blocks off machine spills and leaky IBC tanks. Confines oil, water and chemicals.

- Tacky, flexible polyurethane seals tight to floors.
- Nonabsorbent, washable and reusable.

**High Profile** – 4<sup>1</sup>/<sub>2</sub>" height for high-volume spills. Interlocking ends for longer runs.

**Low Profile** – 2<sup>1</sup>/<sub>4</sub>" height. Cut to desired length.

MODEL NO.	DESCRIPTION	SIZE L x W x H	WT. (LBS.)	PRICE EACH	
				1	2+
H-8678	High Profile	5' x 4" x 4 <sup>1</sup> / <sub>2</sub> "	16	\$625	\$600
H-8679	Low Profile	10' x 4" x 2 <sup>1</sup> / <sub>4</sub> "	30	775	750

## MODULAR SPILL BERM



Build a **semi-permanent barrier** around leak-prone machines and equipment.

- **Crush-resistant foam** with vinyl covering resists oil, water and chemicals.
- Cut to desired length and secure to floor with sealant.
- 2" height. Withstands light, wheeled equipment.

Kit Includes: (2) 25' straight barriers, (4) corners, (6) sealant tubes, (1) can adhesive and (1) 10' connector vinyl.

SHIPS VIA MOTOR FREIGHT

MODEL NO.	DESCRIPTION	OVERALL SIZE L x W x H	WT. (LBS.)	PRICE EACH	
				1	2+
H-9401	Modular Kit	50' x 5 <sup>1</sup> / <sub>2</sub> " x 2"	25	\$850	\$820

# SPILL CONTAINMENT DRUM SHED



2-Drum Shed, see uline.com

Outdoor drum storage protects against harsh weather and costly spills.

- Sturdy polyethylene construction resists chemicals and corrosion.
- Fits up to four 55-gallon drums with attached pumps and funnels.
- Space-saving rolltop doors provide full front or rear access. Lockable.
- Non-skid, easy-to-clean removable grates.
- Includes drain for emptying spills.



**Optional Ramp** – 1,000 lb. capacity. 10° incline for easy loading/unloading.

Meets EPA, SPCC and NPDES Regulations

\* SPECIFY COLOR: Yellow or Black

MODEL NO.	DESCRIPTION	DIMENSIONS L x W x H	LOAD CAP. (LBS.)	SUMP CAP.	WT. (LBS.)	PRICE EACH	
						1	2+
H-5737*	4-Drum Shed	65 x 58 x 69"	6,000	66 Gal.	269	\$1,745	\$1,695
H-5738	Work Ramp	68 x 31 x 13"	1,000	N/A	65	380	360

SHIPS UNASSEMBLED VIA MOTOR FREIGHT

## FLEXIBLE SPILL TRAYS



H-5739

Contain leaky drums or machinery.

- **Flexible.** Folds to compact size for carrying and storage.
- **Chemical-resistant PVC.**

Meets EPA, SPCC and NPDES Regulations

MODEL NO.	DESCRIPTION	DIMENSIONS L x W x H	SUMP CAP.	WT. (LBS.)	PRICE EACH	
					1	3+
H-5739	Medium	24 x 48 x 6"	30 Gal.	6	\$235	\$225
H-5740	Large	48 x 48 x 6"	60 Gal.	9	275	265

## UTILITY TRAYS

Storage for paint cans, oily parts and leaky car batteries.

- **Corrosion-resistant polyethylene.** Nestable.
- **Ribbed bottom.** Contents rest above spills.



Additional sizes, see uline.com

MODEL NO.	DESCRIPTION	DIMENSIONS L x W x H	SUMP CAP.	WT. (LBS.)	PRICE EACH	
					1	3+
H-5741	Medium	39 x 27 x 5½"	20 Gal.	5	\$110	\$105
■H-5742	Extra Large	48 x 33 x 5½"	29 Gal.	8	155	150

■ SHIPS VIA MOTOR FREIGHT

## SPILL DOLLIES



### POLY-DOLLY®

Transport 55-gallon drums, tilt for dispensing and contain spills.

- 10" polyolefin wheels.

- Ergonomic design allows one person to easily move.
- Containment well holds 5-gallon pail for easy dispensing.
- 80-gallon sump keeps spills from splashing out.

Meets EPA, SPCC and NPDES Regulations

SHIPS VIA MOTOR FREIGHT

MODEL NO.	DESCRIPTION	DIMENSIONS L x W x H	CAPACITY (LBS.)	WT. (LBS.)	PRICE EACH	
					1	3+
H-1844	Poly-Dolly®	69 x 33 x 27"	600	98	\$650	\$640

### DRUM BOGIE

Move big, leaky drums across busy facilities and factories.

- 5 polyolefin swivel casters, 2 locking.

- One size fits all. Holds drums up to 95 gallons.
- Chemical and corrosion-resistant HDPE.
- 12-gallon basin with 4" lip.
- Handle locks upright.



MODEL NO.	DESCRIPTION	DIMENSIONS W x H	CAPACITY (LBS.)	WT. (LBS.)	PRICE EACH	
					1	3+
H-10741	Drum Bogie	36 x 9"	1,250	30	\$315	\$305



## DRUM PLATFORM

Traps leaks and spills from one drum.

- Low profile. Easy to load and unload.
- Removable grates for easy cleaning.
- Chemical, corrosion-resistant polyethylene.



Additional sizes, see [uline.com](http://uline.com)

Meets EPA, SPCC and NPDES Regulations

MODEL NO.	DIMENSIONS L x W x H	LOAD CAP. (LBS.)	SUMP CAP. (LBS.)	WT. (LBS.)	PRICE EACH	
					1	3+
H-2762	27 x 27 x 6 1/4"	2,000	15 Gal.	16	\$125	\$120

## SPILL CONTAINMENT PALLETS

Contain leaks and spills from 55-gallon drums.

- Outstanding corrosion resistance.
- Easy to handle with forklift.
- Non-skid, easy-to-clean removable grates.
- Chemical-resistant polyethylene.
- Meets EPA, SPCC and NPDES regulations.



**FOR FORKLIFT USE**

SHIPS VIA MOTOR FREIGHT

MODEL NO.	DESCRIPTION	DIMENSIONS L x W x H	LOAD CAP. (LBS.)	SUMP CAP.	WT. (LBS.)	PRICE EACH	
						1	3+
H-4032	2 Drum	49 x 25 x 18"	2,500	66 Gal.	50	\$250	\$240
H-4033	2 Drum w/ Drain	49 x 25 x 18"	2,500	66 Gal.	50	270	260
H-4034	4 Drum	49 x 49 x 11"	6,000	73 Gal.	77	350	340
H-4035	4 Drum w/ Drain	49 x 49 x 11"	6,000	73 Gal.	77	370	360

## SPILL CONTAINMENT WORKSTATIONS

Low-profile workstations protect floors from spills and leaks from drums.

- Configure drum handling and dispensing areas.
- Tough, high-density polyethylene construction.
- Resists chemicals, rust and corrosion.
- Withstands extreme temperatures -20° to 120°F.
- Non-skid, easy-to-clean removable grates.
- Ramp – 1,000 lb. capacity. Easy loading/unloading.
- Meets EPA, SPCC and NPDES regulations.



**NOT FOR FORKLIFT USE**

SHIPS VIA MOTOR FREIGHT

MODEL NO.	DESCRIPTION	DIMENSIONS L x W x H	LOAD CAP. (LBS.)	SUMP CAP.	WT. (LBS.)	PRICE EACH	
						1	3+
H-4865	1 Drum	25 x 25 x 6"	2,000	12 Gal.	16	\$115	\$110
■H-4036	2 Drum	49 x 25 x 6"	2,500	24 Gal.	33	170	160
■H-4037	4 Drum	49 x 49 x 6"	6,000	49 Gal.	65	280	270
H-4038	Work Ramp	33 x 48 x 6"	1,000	N/A	42	215	205
H-4039	Connectors	Set of 2	N/A	N/A	2	15	14



Connectors – Create custom configurations. Securely connect two or more workstations. Sold in pairs.

## DRUM OVERPACKS



Safely transport, store and secure leaky or damaged drums or pails.

- Excellent spill containment for hazardous waste. Nestable.
- Rugged polyethylene resists weather and chemicals. Screw top lids.

**H-10740** – Recommended for punctured pails, jugs or cans.



H-10740

Meets DOT 49 CFR 173.3, EPA, SPCC and NPDES

SHIPS VIA MOTOR FREIGHT

MODEL NO.	FOR USE WITH	DIMENSIONS W x H	UN RATING	CAPACITY (GAL.)	WT. (LBS.)	PRICE EACH	
						1	3+
H-10740	Pails	22 x 19"	1H2/X75/S	20	11	\$110	\$105
■H-5067	Drums	32 x 42"	1H2/X295/S	95	45	310	295



The Mack Truck of IBC heaters. Protect adhesives and nonflammable chemicals from thickening or freezing.

- Full-coverage wrap spreads heat evenly. Won't burn or scorch product.
- Programmable digital thermostat. 6' cord.
- Auto shutoff prevents overheating.
- Weatherproof and water-resistant vinyl cover.
- Fits nearly every standard IBC tank.

MODEL NO.	DESCRIPTION	IBC MATERIAL	FITS IBC TANK SIZE	THERMOSTAT RANGE	VOLTS	WATTS	PRICE EACH	
							1	3+
H-8022	IBC Tank Heater	Steel or Plastic	275 Gallon	-30 - 145°F	120	1,440	\$1,650	\$1,600
H-8023			330 Gallon				1,925	1,875

## IBC WRENCH



Open and close 6" IBC fill caps.

- Double handles provide maximum leverage.
- Aluminum construction.
- Torque tighten for shipping.

MODEL NO.	DESCRIPTION	SIZE L x W x H	WT. (LBS.)	PRICE EACH	
				1	3+
H-9699	IBC Wrench	17 x 9 x 4"	2	\$85	\$80

## IBC REPLACEMENT CAP



Protect valuable IBC tank contents.

- 6" diameter fill cap includes 2" center plug.
- Impact and weather resistant HDPE.
- Gasket ensures tight, secure seal.

MODEL NO.	DESCRIPTION	WT. (LBS.)	PRICE EACH
H-3886-CAP	IBC Tank Replacement Cap	1	\$32



## IBC HOSE

Gravity-fed hose easily dispenses detergents, fuels and water.

- Corrosion-resistant polypropylene squeeze nozzle.
- 8' steel wire-reinforced PVC hose.
- Stainless steel clamps.

MODEL NO.	DESCRIPTION	FLOW RATE	MAX. VISCOSITY	WT. (LBS.)	FDA COMPLIANT PRICE EACH	
					1	3+
H-8027	2" Female NPS	8 gal./min.	1,000 cps	6	\$130	\$125



## IBC PUMP

Pump fluids directly from IBC tanks.

- Dispenses on both the up and down stroke for fast flow.
- 46" deep reach.
- Safety strap locks pump.

MODEL NO.	FITS CONTAINER	FLOW RATE/STROKE	FITS NECK SIZE	WT. (LBS.)	FDA COMPLIANT PRICE EACH	
					1	3+
H-9533	275 - 350 Gal.	16 oz.	2"	4	\$100	\$95



## IBC SPILL CONTAINMENT PALLET

IBC Tanks, see page 609

Captures leaks and spills from IBC tanks.

- Platform supports up to two 50" square IBC Tanks stacked vertically.
- Includes drain and integrated pail holder.
- Easy to handle with forklift.
- Non-skid, easy-to-clean removable grates.
- Chemical, corrosion-resistant polyethylene.

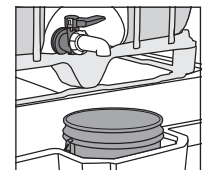

Meets EPA, SPCC and NPDES Regulations

SHIPS VIA MOTOR FREIGHT

MODEL NO.	DESCRIPTION	DIMENSIONS L x W x H	LOAD CAP. (LBS.)	SUMP CAP.	WT. (LBS.)	PRICE EACH	
						1	2+
H-4435	2 IBC w/ Drain	80 x 73 x 30"	8,000	385 Gal.	293	\$1,575	\$1,525

# IBC TANKS

## STEEL PALLETS

Hold as much liquid as six 55-gallon drums. Use up to 33% less floor space.

- Store and dispense water, pesticides or other liquids and powders.
- Chemical-resistant HDPE tank surrounded by a galvanized steel cage.
- Industry standard on/off butterfly valve.
- Stack up to 3 high.
- 4-way fork access.
- 6" diameter fill cap, 2" diameter drain.



Pallet Trucks, see page 427



**HOLD UP TO SIX 55-GALLON DRUMS**

### MEETS FDA REQUIREMENTS

MODEL NO.	DESCRIPTION	DIMENSIONS L x W x H	CAPACITY	UN RATING	WT. (LBS.)	PRICE EACH	
						1	3+
H-3886	IBC Tank	48 x 40 x 46"	275 Gallon	31HA1/Y	128	\$595	\$585
H-4420		48 x 40 x 53"	330 Gallon		146	635	615

SHIPS VIA MOTOR FREIGHT

## PLASTIC PALLETS

Plastic pallet won't scratch or mar floors in food processing plants.

- Store and dispense cooking oils, syrups or other liquids and powders.
- Chemical-resistant HDPE tank surrounded by a galvanized steel cage.
- Stack up to 3 high.
- 4-way access.
- 6" diameter fill cap, 2" diameter drain.

### MEETS FDA REQUIREMENTS

MODEL NO.	DESCRIPTION	DIMENSIONS L x W x H	CAPACITY	UN RATING	WT. (LBS.)	PRICE EACH	
						1	3+
H-10775	IBC Tank	48 x 40 x 46"	275 Gallon	31HA1/Y	138	\$625	\$615
H-10776		48 x 40 x 53"	330 Gallon		156	665	645

SHIPS VIA MOTOR FREIGHT



BALL VALVE

Pallet won't rust or dent.

# STAINLESS STEEL IBC TANK

Keep diesel, kerosene and harsh chemicals on hand or ship cross-country.

- 10 gauge, type 304 stainless steel. Corrosion-resistant for long service life.
- 3-way fork access for easy transport. Stack up to 3 high.
- 22½" diameter fill opening with gasket lid. 3" vent and 2" drain.
- Sloped bottom for complete product drainage.

### DOT APPROVED

MODEL NO.	DESCRIPTION	DIMENSIONS L x W x H	CAPACITY	UN RATING	WT. (LBS.)	PRICE EACH
H-8669	Stainless Steel	48 x 42 x 51"	350 Gallon	31A/Y	465	\$4,350

SHIPS VIA MOTOR FREIGHT



**350 GALLON CAPACITY**

# IBC STAND



Elevates IBC tanks by 2 feet for easy dispensing.

- Stack up to 2 IBC tanks to save warehouse space.
- Heavy duty, powder-coated steel. 1¼" lip secures tank.
- Compatible with most IBC tanks.



SHIPS UNASSEMBLED VIA MOTOR FREIGHT

MODEL NO.	DESCRIPTION	DIMENSIONS L x W x H	LOAD CAPACITY (LBS.)	WT. (LBS.)	PRICE EACH	
					1	2+
H-9704	IBC Stand	52 x 52 x 27½"	8,000	205	\$895	\$870



# STEEL DRUMS



Store and ship liquids or solids.

- Withstands extreme temperatures of -30° to 250°F.
- Features 2" opening to pour and 3/4" opening to vent.

**Open Top:** Includes removable top and bolt ring.

**Closed Top:** Secure non-removable top.

**Lined:** Epoxy/phenolic coating  
resists corrosion.



UNLINED				UNLINED	LINED	MEETS TITLE 49 CODE	
MODEL NO.	DESCRIPTION	CAP.	UN RATING	THICKNESS (mm) TOP/BODY/BOTTOM	WT. (LBS.)	PRICE EACH	
						1	4+
S-21718	Open Top	10 Gal.	1A2/Y1.2/100	0.9/0.9/0.9	16	\$100	\$95
S-19411		16 Gal.	1A2/Y1.2/100	0.9/0.9/0.9	17	105	100
■S-14364	Open Top	30 Gal.	1A2/Y1.5/150	1.4/1.1/1.1	34	130	124
■S-14365	Closed Top		1A1/X1.8/300	1.1/0.8/1.1	23	115	109
■S-10758	Open Top	55 Gal.	1A2/Y1.6/150	1.0/1.0/1.0	43	149	143
■S-10759	Closed Top		1A1/X1.8/300	1.2/0.9/1.2	37	135	128

SPILL CONTAINMENT,  
SEE PAGES 604-608 AND ULINE.COM

LINED				FDA COMPLIANT. MEETS TITLE 49 CODE.			
■S-19414	Open Top	30 Gal.	1A2/Y1.5/150	1.4/1.1/1.1	34	\$149	\$143
■S-16913	Open Top	55 Gal.	1A2/Y1.6/150	1.0/1.0/1.0	45	175	168
■S-16914	Closed Top		1A1/X1.8/300	1.2/0.9/1.2	38	161	153

■ SHIPS VIA MOTOR FREIGHT

# STAINLESS STEEL DRUMS



Store and ship the finest wines, perfumes or printer ink.

- Type 304 stainless steel keeps your product pure.
- Best corrosion resistance, tensile strength and reusability.
- Withstands extreme temperatures of -60° to 160°F.
- Includes removable top, bolt ring and rubber gasket.

				FDA COMPLIANT			
MODEL NO.	DESCRIPTION	CAP.	UN RATING	THICKNESS (mm) TOP/BODY/BOTTOM	WT. (LBS.)	PRICE EACH	
						1	4+
S-20529	Open Top	30 Gal.	1A2/X225/S 1A2/Y1.5/150	1.5/1.2/1.2	35	\$720	\$705
■S-17353		55 Gal.	1A2/X440/S 1A2/Y1.5/150		50	895	875

■ SHIPS VIA MOTOR FREIGHT

## DRUM TRUCK

Move, tilt and unload heavy steel drums with ease.



- Adjustable clip locks drum into place.
- Spring-loaded axle for extra leverage to move and balance heavy loads.
- Easy to move on 10" rubber wheels.

SHIPS ASSEMBLED VIA MOTOR FREIGHT

MODEL NO.	WHEEL TYPE	DRUM CAPACITY		WT. (LBS.)	PRICE EACH	
		(GALLONS)	(LBS.)		1	3+
H-1233	Rubber	30, 55	1,000	74	\$420	\$410

## DISPENSING DRUM TRUCK

Move, tip and drain steel drums. Doubles as a drum cradle.



- Adjustable 2" stability strap.
- Rollers on frame allow for easy drum rotation and faucet positioning.
- Kickstand for upright storage. 10" rubber wheels.

SHIPS ASSEMBLED VIA MOTOR FREIGHT

MODEL NO.	WHEEL TYPE	DRUM CAPACITY		WT. (LBS.)	PRICE EACH	
		(GALLONS)	(LBS.)		1	3+
H-4898	Rubber	30, 55	1,000	49	\$310	\$300

# FIBER DRUMS

Safely ship and store dry or solid products.

- Steel rings reinforce top and bottom. • Metal cover.
- Locking steel band accepts a tamper-evident seal.
- Economical and stackable. • FDA compliant.



\*Square, all fiber, UN rating applies when wrapped three times with S-10195 tape

MODEL NO.	CAPACITY	CAPACITY (LBS.)	UN RATING	WT. (LBS.)	PRICE EACH (MIN. 2)		
					2	10	20+
S-12784*	5 Gallon	225	1G/Y60/S	4	\$34	\$32	\$31
S-10756	10 Gallon	225	1G/Y71/S	6	45	43	40
S-17005	15 Gallon	300	1G/Y120/S	7	47	45	43
S-11877	20 Gallon	300	1G/Y120/S	9	50	48	46
S-9944	30 Gallon	300	1G/Y141/S	11	64	60	58
■S-7900	55 Gallon	400	1G/Y190/S	17	77	73	68
■S-17006	75 Gallon	400	1G/X120/S	19	90	84	77

■ SHIPS VIA MOTOR FREIGHT

# PLASTIC DRUMS

Excellent for indoor or outdoor use. Corrosion-free, dent-resistant polyethylene.

**Open Top:** 15 gal. stores up to 143 lbs.; 30 gal., 395 lbs.; 55 gal., 550 lbs. of solids. Quick-lock lid (included) won't pop open during transit.

**Closed Top:** 15 gal. stores up to 225 lbs.; 30 gal., 450 lbs.; 55 gal., 870 lbs. of liquids and solids. Two openings to pour and vent.



FDA COMPLIANT

\* SPECIFY COLOR: Blue, Natural or Black

MODEL NO.	COLOR	TOP	CAPACITY	UN RATING	WT. (LBS.)	PRICE EACH		
						1	4	8+
S-19412	Blue	Closed	5 Gallon	1H1/Y1.8/150	3	\$22	\$21	\$20
S-19413	Natural	Closed	5 Gallon	1H1/Y1.8/150	3	\$22	\$21	\$20
S-24088	Blue	Open	15 Gallon	1H2/Y105/S	9	65	63	61
S-17007	Blue	Closed	15 Gallon	1H1/Y1.8/100	7	49	47	45
S-19418	Natural	Closed	15 Gallon	1H1/Y1.8/100	7	49	47	45
S-11860	Blue	Open	30 Gallon	1H2/Y180/S	16	88	85	80
S-19419	Natural	Open	30 Gallon	1H2/Y180/S	16	88	85	80
S-11861	Blue	Closed	30 Gallon	1H1/Y1.8/100	14	76	73	68
S-17008	Natural	Closed	30 Gallon	1H1/Y1.8/100	14	76	73	68
■S-9945	Specify*	Open	55 Gallon	1H2/Y250/S**	25	94	\$89 each	
■S-10757		Closed		1H1/Y1.9/100	22	82	\$78 each	

\*\*Natural UN Rating: 1H2/Y130/S

■ SHIPS VIA MOTOR FREIGHT

# PLASTIC DRUM FAUCETS



Empty a 55-gallon drum in as little as 3 minutes.

- Recommended for light oils and cleaning solutions.
- Use with plastic and steel drums.
- Tough polyethylene.

FDA COMPLIANT

MODEL NO.	DESCRIPTION	FITS NECK SIZE	PRICE EACH	
			3	12+
H-2955	Plastic with	3/4"	\$3	\$2
H-2956	Lever Handle	2"	17	16

# BRASS DRUM FAUCETS

Empty a 55-gallon drum in as little as 2 minutes.

- Recommended for adhesives and paints.
- Use with plastic and steel drums.
- Heavy-duty brass is self-closing with a PTFE seal.



MODEL NO.	DESCRIPTION	FITS NECK SIZE	PRICE EACH	
			1	3+
H-4934	Faucet	3/4"	\$44	\$41
H-4935	Gate Valve	2"	140	130

H-4935

# RED PLASTIC DRUMS

When identifying contents is important, use this high-visibility drum.

- Corrosion-free, dent-resistant seamless polyethylene. Two openings to pour and vent. Indoor/outdoor use.

**Open Top** – Stores up to 660 lbs. of solids. See through, quick-lock lid.

**Closed Top** – Stores up to 835 lbs. of liquids.

FDA COMPLIANT

SHIPS VIA MOTOR FREIGHT

MODEL NO.	TOP	CAPACITY	UN RATING	WT. (LBS.)	PRICE EACH		
					1	4	8+
S-20852	Open	55 Gallon	1H2/X150/S	22	\$145	\$140	\$135
S-20853	Closed		1H1/Y1.9/150		115	110	105



# STEEL DRUM GRABBER



Lift, transport and deposit steel drums with your forklift.

- Slides onto fork and tightens without tools.
- Jaws automatically close and lock onto drum.
- For 55-gallon steel drums.

- All-welded steel construction. Tough powder-coat finish.

SHIPS ASSEMBLED VIA MOTOR FREIGHT

MODEL NO.	DRUM MATERIAL	DRUM CAPACITY		FORK POCKETS W x H	WT. (LBS.)	PRICE EACH	
		(GALLONS)	(LBS.)			1	3+
H-1843	Steel	55	1,500	6¼ x 2"	109	\$515	\$495

For open and closed drums

# UNIVERSAL DRUM GRABBER

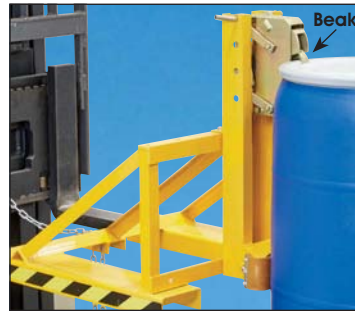

Lift and transport steel, plastic and fiber drums with your forklift.

- Tough steel beak automatically clamps to top lip of drum.
- Will not unlock until lowered to ground.

- Powder-coated steel frame. Includes 3½' safety chain.

SHIPS VIA MOTOR FREIGHT

MODEL NO.	DRUM MATERIAL	DRUM CAPACITY		FORK POCKETS W x H	WT. (LBS.)	PRICE EACH	
		(GALLONS)	(LBS.)			1	3+
H-7170	All	30, 55, 85	1,100	5¾ x 2"	120	\$645	\$615

For open and closed drums

# DRUM BLANKET HEATER

The Maserati of drum heaters! Keep waxes, oils and adhesives at a precise temperature.

- Full coverage wrap spreads heat evenly.
- Digital thermostat for temperature control. 6' cord.
- Auto shutoff prevents overheating.
- Weatherproof and water-resistant vinyl cover.



INDOOR/OUTDOOR USE

ETL/C-ETL Listed

MODEL NO.	DRUM MATERIAL	FITS DRUM SIZE	THERMOSTAT RANGE	VOLTS	WATTS	PRICE EACH	
						1	3+
H-5686	Steel or Plastic	55 Gal.	-30 - 145°F	120	800	\$960	\$930

# DRUM HEATERS

Keep drum contents from freezing.

- Adjustable thermostat with 6' power cord.

## ECONOMY

- Maintain temperature in drums.

- Fiberglass reinforced silicone rubber resists moisture and chemicals.

## HEAVY DUTY

- Rapid heating and all-day use.
- 3 wattage settings.
- Durable aluminized steel resists corrosion.



H-2962



H-4932

FOR 55-GALLON DRUMS

UL/C-UL Recognized

MODEL NO.	DESCRIPTION	DRUM MATERIAL	THERMOSTAT RANGE	VOLTS	WATTS	PRICE EACH	
						1	3+
H-2961	Economy	Plastic	50 - 160°F	120	300	\$295	\$280
H-2962		Steel	50 - 425°F				
H-4931*	Heavy Duty	Steel	60 - 250°F	120	1,750	385	365
H-4932*			200 - 400°F				

\* UL Listed



# DRUM DOLLIES

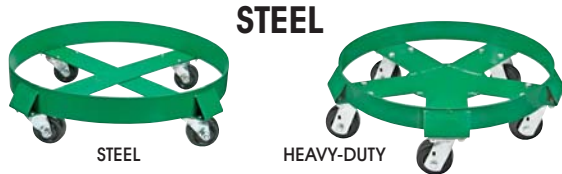

## STEEL

**Steel** – All-welded construction. 2½" lip. 3 x 1½" casters.

**Heavy-Duty Steel** – Stable and strong. Holds up to 2,000 lbs. 2½" lip. Five 4 x 2" oversized casters, 2 locking. All-welded construction.

MODEL NO.	DESCRIPTION	FITS DRUM SIZE	CAPACITY (LBS.)	WT. (LBS.)	PRICE EACH	
					1	3+
H-7740	Steel	16 Gallon	1,000	19	\$63	\$60
H-3742		30 Gallon		21	68	65
H-1234		55 Gallon		27	74	70
H-5730	Heavy-Duty Steel	55 Gallon	2,000	45	150	140



## PLASTIC

Resists rust, denting. Solid bottom contains spills. 2" lip. Five 3" casters provide greater mobility.

MODEL NO.	DESCRIPTION	FITS DRUM SIZE	CAPACITY (LBS.)	WT. (LBS.)	PRICE EACH	
					1	3+
H-9757	Uline	55 Gallon	900	16	\$105	\$95
H-2747	Rubbermaid®		500	13	140	130

## STAINLESS STEEL



Withstands rust and daily washdowns. For wet and sanitary environments. 2½" lip. 3 x 1½" casters.

MODEL NO.	DESCRIPTION	FITS DRUM SIZE	CAPACITY (LBS.)	WT. (LBS.)	PRICE EACH	
					1	3+
H-7103	Stainless Steel	55 Gallon	800	24	\$195	\$185

# DRUM COVERS



**Flexible** – Protect bung heads from dust and debris.

**Elastic** – Snug fit. Easily slip on/off for inspection.

**FLEXIBLE – FOR 55-GALLON STEEL DRUMS**

FDA COMPLIANT

MODEL NO.	DESCRIPTION	MIL	QTY./CTN.	PRICE/CARTON	
				1	3+
S-19368	Closed Top	40	25	\$210	\$200

SPECIFY COLOR: Black or Clear

**ELASTIC – FOR ALL DRUM TYPES**

FDA COMPLIANT

MODEL NO.	DESCRIPTION	MIL	QTY./CTN.	PRICE EACH	PRICE EACH
S-12586	30 Gallon	4	100	\$159	\$152
S-12587	55 Gallon			187	180

# ULINE DRUM LINERS

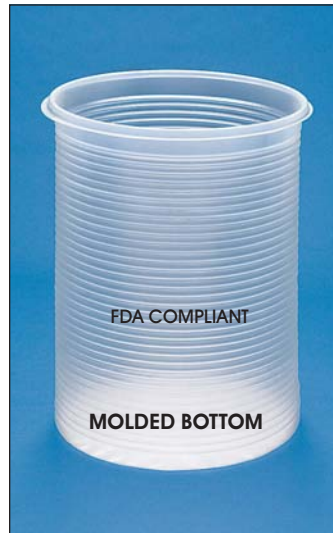

**ROUND BOTTOM** – Strong, uniform circular bottom seal molds liner to the shape of the drum.

- Holds paints, inks, powders and food items.

**MOLDED** – Completely leakproof.

- Molded lip holds liner in place. 30 and 55 gallon ship and store flat.
- Withstand pumping and mixing – Won't tear and crack.
- **Accordion** – Side wall adjusts to varying heights.
- **Smooth** – Allows for full product recovery.

## ROUND BOTTOM

MODEL NO.	DIMENSIONS		CAPACITY (GALLONS)	MIL	QTY./CTN.	PRICE/CARTON	
	W x L	CIRCUMFERENCE				1	3+
S-20528	18 x 22"	36"	5	4	150	\$320	\$305
S-11856	30 x 35"	60"	30	4	150	435	420
S-11857	30 x 35"			8	75	355	340
S-5849	37 x 40"	74"	55	4	60	220	210
S-5850	37 x 56"				50	\$195/carton	
S-19364	37 x 56"			6	40	245	235
S-5851	37 x 40"			8	40	250	240
S-5852	37 x 56"	30	230		220		
S-14456	37 x 56"	10	20		210	200	

## MOLDED – ACCORDION

MODEL NO.	DIMENSIONS		CAPACITY (GALLONS)	MIL	QTY./CTN.	PRICE/CARTON	
	W x L	CIRCUMFERENCE				1	3+
S-11859	18¼ x 29"	57"	30	15	25	\$305	\$295
S-7563	22½ x 33¾"	70"	55		20	290	280

## MOLDED – SMOOTH

MODEL NO.	DESCRIPTION	MIL	QTY./CTN.	PRICE EACH	PRICE EACH		
S-11858	12¼ x 13¾"	36"	5	15	100	\$335	\$320
S-12588	18¼ x 29"	57"	30		25	340	325
S-12589	22½ x 33¾"	70"	55		20	290	280

# STEEL PAILS AND LIDS



CLOSED TOP

LINED

OPEN TOP

Store bulk lubricants and thinners. Rugged and versatile.  
**Open Top** – Steel handle. Empty pails nest for storage.  
**Closed Top** – 2 1/8" screw cap with pullout dispensing spout.  
**Lined** – Epoxy coating resists corrosion. Black only.



**Lug Lid**  
Secure with crimping tool, see uline.com

**Lug Lid w/ Spout**  
Convenient, easy dispensing.

**Lever Lock Lid**  
Quick, easy open and close. Reusable.

## 5-GALLON PAILS

MODEL NO.	DESCRIPTION	PRICE EACH (MIN. 3)			SKID LOTS	
		3	10	20+	QTY.	PRICE EACH
S-20030	Open Top	\$15	\$14	\$13	120	\$11
S-21134*	Closed Top	30	29	28	36	25
S-24962	Lined Open Top	17	16	15	120	13

\* UN Rating 1A1/Y1.8/100

SPECIFY COLOR: Black or Gray

## LIDS – UNLINED

Min. 3

## LIDS – LINED

Min. 3

MODEL NO.	DESCRIPTION	PRICE EACH	MODEL NO.	DESCRIPTION	PRICE EACH
S-25307	Lug Lid	\$5	S-25308	Lug Lid	\$6
S-20036	Lug Lid w/ Spout	7	S-24963	Lug Lid w/ Spout	8
S-21135	Lever Lock Lid	11	S-24964	Lever Lock Lid	12

SPECIFY COLOR: Black or Gray

Available in Black only

# PAIL PUMPS



Dispense liquids from pails without messy spills or drips.

## ECONOMY PLASTIC

- Use with light oils and water-based fluids.
- Includes 2 5/8" pail adapter, 3/4" and 2" bung adapters.

## DELUXE PLASTIC

- For corrosive chemicals, acids and oils.
- Includes 2 5/8" pail adapter and 70mm screw cap adapter.



## FDA COMPLIANT

\* Type 316 stainless steel and PTFE

MODEL NO.	DESCRIPTION	FITS CONTAINER	FLOW RATE/STROKE	REACH BELOW PAIL LID	WT. (LBS.)	PRICE EACH	
						1	3+
H-2634	Economy Plastic	3.5 - 55 Gal.	2, 4, 6 or 8 oz.	33"	1	\$15	\$14
H-4896	Deluxe Plastic	3.5 - 7 Gal.	6 oz.	16.5"	1	47	44
H-4897*	Stainless Steel	3.5 - 7 Gal.	8 oz.	20"	2	99	89

## STAINLESS STEEL

- Recommended for flammables, solvents and aggressive chemicals.
- Includes 2 5/8" pail adapter and 2" bung adapter.

# ELECTRIC DRUM PUMP



Flip a switch to quickly drain acids, solvents and detergents.

- Empty a 55-gallon drum in 3 minutes. 5' discharge tube.
- 1/2 HP, 6.3 amps, 115 Volts.
- 8' cord with on-off switch.
- Type 316 stainless steel with Teflon® seals. Excellent corrosion resistance.
- E-cigarette liquids – Use High Viscosity Pump, see uline.com

35" reach below drum lid

MODEL NO.	MAX. VISCOSITY	FITS CONTAINER	FLOW RATE	FITS NECK SIZE	WT. (LBS.)	PRICE EACH
H-4933	1,000 cps	15 - 55 Gal.	17 gal./min.	2"	18	\$679

# SIPHON DRUM PUMP



Dispense mild corrosives, detergents, light oils and waxes.

- Empty a 55-gallon drum in 8 minutes. 4' discharge tube.

## FDA COMPLIANT

34" reach below drum lid

MODEL NO.	FITS CONTAINER	FLOW RATE	FITS NECK SIZE	WT. (LBS.)	PRICE EACH		
					1	12	24+
S-17128	15 - 55 Gal.	7 gal./min.	2"	1	\$18	\$16	\$14

# DRUM PLUG OPENER



Unscrew plugs and bungs.

- Non-sparking bronze alloy for flammable materials.



MODEL NO.	DESCRIPTION	HANDLE LENGTH	WT. (LBS.)	PRICE EACH	
				1	3+
H-1552	Bung Wrench	7 1/2"	2	\$60	\$58

# DRUM PUMPS

Dispense liquids from drums without spilling a drop.

## STEEL

- Recommended for thick, noncorrosive, nonflammable cleaners and oils.
- Chrome-plated steel.

## PLASTIC

- For corrosive chemicals, acids and salt water.
- Not for use with solvents or flammable liquids.

## STAINLESS STEEL

- Recommended for kerosene, solvents and aggressive chemicals.
- Type 304 stainless steel and PTFE.
- Includes grounding stud.

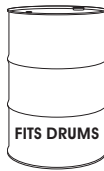

MODEL NO.	DESCRIPTION	FITS CONTAINER	FLOW RATE/STROKE	FITS NECK SIZE	REACH BELOW DRUM LID	* FDA COMPLIANT		
						WT. (LBS.)	PRICE EACH	
						1	3+	
H-1235	Steel		22 oz.			5	\$34	\$31
H-1553*	Plastic	15 - 55 Gal.	16 oz.	2"	37"	3	77	72
H-3864*	Stainless		22 oz.			5	109	99

# ROTARY DRUM PUMPS



Simple, one-motion dispensing for quick liquid transfers.

## PLASTIC

- For water-based solutions, waxes and detergents.
- Polypropylene with PTFE seals.

## STAINLESS STEEL

- For acids, harsh chemicals and fuels.
- Type 304 stainless steel with PTFE seals.

FM Approved Pump, see uline.com

\* FDA COMPLIANT

MODEL NO.	DESC.	FITS CONTAINER	FLOW RATE	FITS NECK	WT. (LBS.)	PRICE EACH	
						1	3+
H-4377	Plastic	15 - 55 Gal.	8 gal./min.	2"	4	\$99	\$89
H-5647*	Stainless		10 gal./min.		12	459	429

40" reach below drum lid

# LEVER ACTION DRUM PUMPS

Hand crank dispenses liquids in cabinets and confined spaces.

- Adjustable flow rate.

## PLASTIC

- For water-based cleaning solutions and chemicals.
- Polypropylene with PTFE seals.

## STAINLESS STEEL

- For acids, harsh chemicals and corrosive liquids.
- Type 304 stainless steel with PTFE seals.



MODEL NO.	DESCRIPTION	FITS CONTAINER	FLOW RATE	FITS NECK	WT. (LBS.)	PRICE EACH	
						1	3+
H-9773	Plastic	15 - 55 Gal.	9 gal./min.	2"	2	\$65	\$60
H-9774	Stainless				6	240	220



# DRUM FUNNELS

**POLY** – Transfer nonflammable liquids. Lockable.

- Polyethylene resists dents and corrosion.
- Removable screen filter.

**SAFETY** – Quickly and safely transfer flammable solvents, oils and thinners.

- In case of fire, lid automatically shuts to extinguish flames.
- Brass tube with flame arrestor protects contents from external sparks.
- 18-gauge galvanized steel funnel.
- Lockable.



## POLY

MODEL NO.	FUNNEL DIAMETER x H	FITS NECK SIZE	CAP. (GAL.)	WT. (LBS.)	PRICE EACH	
					1	3+
H-5648	10 x 8 1/2"	2"	1	2	\$26	\$24

## SAFETY

MODEL NO.	FUNNEL DIAMETER x H	TUBE LENGTH	FITS NECK SIZE	CAP. (GAL.)	WT. (LBS.)	EPA AND OSHA COMPLIANT. FM APPROVED. PRICE EACH	
						1	3+
H-3865	11 x 10"	6"	2"	2.6	8	\$280	\$275



# SCREW TOP PAILS



Quickly open and reseal for easy access.

- Vacuum tight – Use with granulars, fine powders.
- Lid includes neoprene gasket for moisture-resistant storage.
- Tamper evident with use of cable ties (see pgs. 156-159).
- Molded, high-density polyethylene.

FDA COMPLIANT LIDS INCLUDED. SPECIFY LID COLOR: Blue, Red or White

MODEL NO.	CAPACITY	MIL	UN RATING	PRICE EACH (MIN. 5)		
				5	10	50+
S-20029	0.6 Gallon	46	1H2/Y4/S	\$5.25	\$5.00	\$4.75
S-18114	1.25 Gallon	62	1H2/Y6/S	7.25	6.75	6.25
S-18115	2.5 Gallon	75	1H2/Y13/S	13.25	12.50	11.50
S-15636	3.5 Gallon	80	1H2/Y19/S	15.00	14.25	13.25
S-13652	5 Gallon	90	1H2/Y30/S	17.25	16.50	15.50
S-15637	6.5 Gallon	90	1H2/Y30/S	19.75	19.00	17.75



## SQUARE PAILS

Stack and palletize easily for shipping or storage.

- Built-in handgrips.
- Tear-tab lids protect contents, sold separately.
- Molded, high-density polyethylene.

FDA COMPLIANT \* SPECIFY COLOR: White or Black

MODEL NO.	CAPACITY	MIL	PRICE EACH (MIN. 5)			LIDS (MIN. 5)	
			5	10	50+	MODEL NO.	PRICE EACH
S-21743▲	2 Gallon	60	\$4.30	\$4.15	\$3.95	S-21744▲	\$1.55
S-13650*	4 Gallon	75	6.40	6.10	5.85	S-13651*	1.65
S-16971	5 Gallon	70	11.40	10.95	10.45	S-16972	2.95

▲ Made of white polypropylene

## SCREW TOP PAILS

UN certified to transport pool chemicals and hazardous liquids.

- Vacuum tight seal.
- Built-in turning handle for easy access.
- Molded, high-density polyethylene.



FOR LIQUIDS

FDA COMPLIANT WHITE LIDS INCLUDED

MODEL NO.	CAPACITY	MIL	UN RATING	PRICE EACH (MIN. 5)		
				5	10	50+
S-20606	5 Gallon	90	1H2/Y1.5/30 & 1H2/Y30/S	\$20.75	\$20.00	\$19.00
S-20607	5 Gallon w/ Spout	90		21.25	20.50	19.50

## JERRICANS



Store or transport chemicals and liquids.

- Square shape cubes out pallets.
- High-density polyethylene.
- FDA compliant.

\* Natural only

SPECIFY COLOR: Blue or Natural

MODEL NO.	CAPACITY	DIMENSIONS L x W x H	UN RATING	PRICE EACH (MIN. 4)	
				4	12+
S-17470	2.5 Gallon	9 x 8 x 11½"	3H1/Y1.6/150	\$11	\$10
S-17471	5 Gallon	11 x 10 x 14"	3H1/Y1.8/150	20	18
S-24575*	7 Gallon	11 x 10 x 20"	3H1/Y1.8/150	24	22

## CLOSED HEAD POLY PAILS

Ship and store chemicals, powders and flavorings.

- Top handle and bottom grip for easy pouring.
- High-density polyethylene.
- FDA compliant.



MODEL NO.	CAPACITY	COLOR	UN RATING	WT. (LBS.)	PRICE EACH		
					1	4	8+
S-19412	5 Gallon	Blue	1H1/Y1.8/150	3	\$22	\$21	\$20
S-19413		Natural					

# PLASTIC PAILS

Safely store or ship your products in these durable pails.

- High-density polyethylene construction withstands temperatures up to 180°F.
- Stackable with lid. Empty pails nest for storage.

**Standard Lid** – Tear tab for tight, secure seal.

**EZ Peel Lid** – Easy opening, easy sealing. No tools required.

**Gamma Seal Lid** – Turns a 2 to 7 gallon pail into a resealable, screw top container.



FDA COMPLIANT

SPECIFY COLOR: White, Black, Blue, Green, Red, Yellow, Gray, Orange or Natural

MODEL NO.	CAPACITY	MIL	PRICE EACH (MIN. 5)			LIDS (MIN. 5)	
			5	10	50+	MODEL NO.	PRICE EACH
S-24085*	1 Quart	36	\$1.50	\$1.40	\$1.30	S-24086*	\$.40
S-17941	1 Gallon	50	3.15	2.95	2.70	S-17942	.75
S-9941	2 Gallon	65	4.25	3.95	3.60	S-9947	1.05
S-9942	3.5 Gallon	90	6.80	6.25	5.85	S-9948▲	2.00
S-7914▲	5 Gallon	90	\$6.25 any quantity				
S-11862	6 Gallon	90	10.45	9.65	9.10		
S-16969	7 Gallon	100	12.25	11.25	10.50		

▲ Also available in Purple

\* Only available in Black and White

## COMPANION BOX FOR 5 GALLON PAIL

MODEL NO.	SIZE L x W x H	TEST	PRICE PER BOX			BUNDLE/BALE QTY.
			15	90	240+	
S-4936	12½ x 12½ x 15"	275# DW	\$3.63	\$3.34	\$3.13	15 / 150

## SKID LOTS

SAVE UP TO 35%

MODEL NO.	CAPACITY	MIL	QTY. PER SKID	PRICE EACH
S-17941S	1 Gallon	50	768	\$1.99
S-9941S	2 Gallon	65	360	2.99
S-9942S	3.5 Gallon	90	144	5.09
S-7914S	5 Gallon	90	120	5.49
S-11862S	6 Gallon	90	84	7.89
S-16969S	7 Gallon	100	72	9.29



## EZ PEEL LID

Available in all pail colors

MODEL NO.	FITS PAIL SIZES	PRICE EACH (MIN. 5)		
		5	10	50+
S-20541	3.5, 5, 6 and 7 Gallon	\$2.25	\$2.00	\$1.85



## GAMMA SEAL LID

SPECIFY COLOR: White, Red, Blue or Black

MODEL NO.	FITS PAIL SIZES	PRICE EACH		
		1	5	12+
S-20537*	2 Gallon	\$9.20	\$8.05	\$6.90
S-17945	3.5, 5, 6 and 7 Gallon	11.50	10.35	9.20



\* Only available in White

## LID WITH SPOUT

Available in all pail colors

MODEL NO.	FITS PAIL SIZES	PRICE EACH (MIN. 5)		
		5	10	50+
S-9943	3.5, 5, 6 and 7 Gallon	\$2.75	\$2.55	\$2.35



**Pail Openers** – Pry lids off plastic pails and buckets with no cutting.



FREE

H-1468 Pail Opener with any \$125+ Pail and/or Lid Order Upon Request.

MODEL NO.	PRICE EACH
H-1468	\$7.95

# 5 GALLON ECONOMY PAIL

Light duty for cleaning, carrying tools and storage.

- High-density polyethylene.
- Tapered for easy stacking.

SPECIFY COLOR: Black, Blue, White or Red

FDA COMPLIANT

MODEL NO.	CAPACITY	MIL	PRICE EACH (MIN. 10)			LIDS (MIN. 5)	
			10	50	120+	MODEL NO.	PRICE EACH
S-16970	5 Gallon	75	\$5.35	\$5.10	\$4.90	S-9948	\$2.00





## UTILITY JUGS

Mix, transport and store liquids.

- Round, narrow-mouth containers are easy to carry, easy to pour.
- Heavy-duty polyethylene. Caps included.
- Induction Sealer and Caps available, see [uline.com](http://uline.com)

FDA COMPLIANT SOLD IN CASE QUANTITIES

MODEL NO.	SIZE	CAP SIZE	COLOR	QTY./CASE	PRICE PER JUG	
					1 CASE	3+ CASES
S-19295	32 oz.	28/410	Natural	24	\$1.30	\$1.10
S-13509	1/2 Gal.	38/400	Natural	12	1.95	1.60
S-10746	1 Gal.	38/400	Natural	12	2.85	2.35
S-10747			White		2.90	2.40

**BULK PACKS** **SAVE UP TO 45%** SOLD IN CASE QUANTITIES

MODEL NO.	SIZE	CAP SIZE	COLOR	QTY./CASE	PRICE PER JUG	
					1 CASE	4+ CASES
S-19295B	32 oz.	28/410	Natural	100	\$ .95	\$ .85
■ S-13509B	1/2 Gal.	38/400	Natural	84	1.25	1.05
■ S-10746B	1 Gal.	38/400	Natural	48	<b>\$1.75 any qty.</b>	
■ S-10747B			White		2.00	1.80

■ SHIPS VIA MOTOR FREIGHT



## SQUARE UTILITY JUG

Easy-pouring design for soaps, detergents and automotive chemicals.

- Built-in handle with round, narrow mouth.
- Square shape maximizes shelf space.
- Heavy-duty polyethylene.

CAPS INCLUDED

FDA COMPLIANT SOLD IN CASE QUANTITIES

MODEL NO.	SIZE	CAP SIZE	COLOR	QTY./CASE	PRICE PER JUG	
					1 CASE	3+ CASES
S-22920	1 Gal.	38/400	Natural	12	\$2.85	\$2.35

**BULK PACK** **SAVE UP TO 40%** SOLD IN CASE QUANTITIES

MODEL NO.	SIZE	CAP SIZE	COLOR	QTY./CASE	PRICE PER JUG	
					1 CASE	4+ CASES
S-22920B	1 Gal.	38/400	Natural	48	\$1.85	\$1.75



## MIXING CONTAINERS

Lids available, see [uline.com](http://uline.com)

Quickly measure and mix paints, chemicals and adhesives.

- Clearly marked graduations for quick measuring.
- Made of translucent high-density polyethylene.

SOLD IN MULTIPLES OF 25

MODEL NO.	CAPACITY	MIL	PRICE EACH (MIN. 25)		
			25	50	100+
S-22982	1 Quart	33	\$1.00	\$ .95	\$ .90
S-22983	2.5 Quart	33	2.05	1.95	1.85
S-22984	5 Quart	42	3.25	3.10	2.95



## PAINT CANS AND CLIPS

Store and transport paint and coatings.

- Handle makes it easy to carry and pour.
- Epoxy-Lined Cans – For water-based paint.

Plastic Paint Cans, see [uline.com](http://uline.com)



### CLIPS

- Keep paint cans closed during shipping.
- No tools required.

### UNLINED PAINT CANS

MODEL NO.	CAPACITY	DESCRIPTION	QTY./CTN.	PRICE PER CARTON		
				1	3	5+
S-22988	1/4 Pint	No Handle	44	\$80	\$76	\$73
S-19520	1/2 Pint		35	70	66	63
S-15743	1 Pint		24	55	53	50
S-7343	1 Quart		56	143	138	130
S-7342	1 Gallon		34	156	151	144
S-12980	1 Gallon	With Handle	34	160	155	148

### EPOXY-LINED PAINT CANS

S-21238	1/2 Pint	No Handle	35	\$75	\$71	\$68
S-21239	1 Pint		24	59	56	54
S-17946	1 Quart		56	146	141	134
S-14644	1 Gallon	With Handle	34	164	159	152

### CLIPS

MODEL NO.	DESCRIPTION	QTY./BAG	PRICE PER BAG		
			1	5	10+
S-19521	1/4 and 1/2 Pint	1,000	\$59	\$57	\$54
S-8248	Pint/Quart				
S-8249	Gallon				





# F-STYLE JUGS

Space-saving containers for chemicals, cleaners and other liquids.

- Heavy-duty polyethylene. Caps included.
- Black – Protects UV-sensitive contents.
- Replacement caps available, see [uline.com](http://uline.com)



FDA COMPLIANT				SOLD IN CASE QUANTITIES		
MODEL NO.	SIZE	CAP SIZE	COLOR	QTY./CASE	PRICE PER JUG	
					1 CASE	3+ CASES
S-15837	16 oz.	33/400	White	24	\$1.55	\$1.35
S-20040	32 oz.	33/400	Natural	12	1.80	1.60
S-13505			White		1.90	1.65
S-20041	1/2 Gal.	38/400	Natural	12	2.35	2.05
S-13506			White		2.40	2.10
S-13507	1 Gal.	38/400	Natural	12	2.90	2.50
S-10748			White		2.95	2.55
S-18053			Black		3.00	2.60
S-12759	2½ Gal.	63/445	Natural	12	6.65	5.65
S-13508			White		6.70	5.70
S-18054			Black		6.75	5.75
S-16915	5 Gal.	63/Special	Natural	1	14.35	12.55

				BULK PACKS		SAVE UP TO 50%		SOLD IN CASE QUANTITIES		
MODEL NO.	SIZE	CAP SIZE	COLOR	QTY./CASE	PRICE PER JUG		QTY./CASE	PRICE PER JUG		
					1 CASE	3+ CASES		1 CASE	4+ CASES	
S-15837B	16 oz.	33/400	White	240	\$1.00	\$0.90	120	1.35	1.20	
S-20040B	32 oz.	33/400	Natural	120	1.40	1.25				
S-13505B			White		1.45	1.50				
S-20041B	1/2 Gal.	38/400	Natural	60	1.65	1.45	60	1.85	1.60	
S-13506B			White		1.70	1.50				
■S-13507B	1 Gal.	38/400	Natural	60	1.90	1.65	60	1.95	1.70	
■S-10748B			White		1.95	1.70				
■S-18053B			Black		3.85	3.35				
■S-12759B	2½ Gal.	63/445	Natural	90	3.90	3.40	90	3.95	3.45	
■S-13508B			White		3.95	3.45				
■S-18054B			Black		9.65	8.55				
S-16915B	5 Gal.	63/Special	Natural	32	9.65	8.55				

■ SHIPS VIA MOTOR FREIGHT

# EZ-POUR F-STYLE JUGS

Slant handle and extra-wide opening for smooth pouring.

- Store chemicals, cleaners and other liquids.
- Heavy-duty polyethylene. Caps included.



FDA COMPLIANT				SOLD IN CASE QUANTITIES				
MODEL NO.	SIZE	CAP SIZE	COLOR	QTY./CASE	PRICE PER JUG		BULK PACKS	
					1 CASE	3+ CASES	QTY.	PRICE/JUG
S-20045	1 Gal.	63/445	Natural	12	\$3.30	\$2.90	50	\$2.30
S-20046	2½ Gal.				7.10	6.10	108	4.60

# MILK JUGS

Lightweight, corrosion-resistant containers for liquid storage.

- Built-in handle for easy carrying and pouring.
- HDPE. Tamper-evident caps included.



FDA COMPLIANT				SOLD IN CASE QUANTITIES				
MODEL NO.	SIZE	CAP SIZE	QTY./CASE	PRICE PER JUG		SKID LOTS		
				1 CASE	3+ CASES	QTY.	PRICE/JUG	
S-22549	32 oz.	38/DBJ	192	\$0.89	\$0.81	1,920	\$0.63	
S-16911	1/2 Gal.	38/	108	1.07	.98	972	.75	
S-16912	1 Gal.	Special	48	1.45	1.32	432	1.00	

SHIPS VIA MOTOR FREIGHT

# FLUORINATED F-STYLE JUGS

Stop chemicals from leaching into container walls.

- For insecticides, cleaning solvents and oil storage.
- Heavy-duty polyethylene. Caps included.



FDA COMPLIANT				SOLD IN CASE QUANTITIES		
MODEL NO.	SIZE	CAP SIZE	COLOR	QTY./CASE	PRICE PER JUG	
					1 CASE	3+ CASES
S-22890	1 Gal.	38/400	Natural	36	\$3.40	\$3.20
S-22891			White		3.50	3.30

# CARBOYS

Store, mix and dispense cleaning fluids, solvents and water.

- Carboys – 2¼" opening for easy filling. No-drip spigot.
- Racks – Store up to five 5-gallon or ten 2.5-gallon carboys.



\* FDA COMPLIANT

MODEL NO.	CAPACITY	DESCRIPTION	QTY./CASE	PRICE EACH	
				1	4+
S-15648*	2.5 Gallon	Rectangular, Natural	1	\$16	\$15
S-12768*	5 Gallon			23	21
H-1583	3-Shelf Rack			69	66
H-1584	5-Shelf Rack			119	115

# SQUARE WIDE-MOUTH JARS



Ideal for storing and transporting liquids or dry products.

- Wide opening for easy filling.
- FDA compliant.
- Lightweight, high-density polyethylene. Caps included.

SOLD IN CASE QUANTITIES

MODEL NO.	SIZE	OPENING DIAMETER	CAP SIZE	QTY./CASE	PRICE PER JAR		BULK PACKS	
					1 CASE	3+ CASES	QTY.	PRICE/JAR
S-8506	16 oz.	2 1/4"	70/400	36	\$1.85	\$1.75	320	\$1.40
S-8507	32 oz.	3"	89/400	36	2.30	2.20	120	1.65
S-8508	1/2 Gal.			24	3.60	3.40	82	2.80
■S-8509	1 Gal.	4 1/8"	120/400	12	4.70	4.45	48	3.65

■ BULK PACK SHIPS VIA MOTOR FREIGHT

# ROUND WIDE-MOUTH JARS



Store food, liquids or pharmaceuticals. Wide mouth for easy filling.

- Unbreakable, lightweight.
- Corrosion-resistant HDPE.
- FDA compliant.
- Caps included.

NATURAL

SOLD IN CASE QUANTITIES

MODEL NO.	SIZE	OPENING DIAMETER	CAP SIZE	QTY./CASE	PRICE PER JAR		BULK PACKS	
					1 CASE	3+ CASES	QTY.	PRICE/JAR
S-18070	8 oz.	1 3/4"	53/400	36	\$.67	\$.64	375	\$.54
S-18071	16 oz.	3"	89/400	24	1.09	1.02	216	.87
S-18072	32 oz.			24	1.39	1.30	126	1.09
S-17076	1/2 Gal.	3 3/4"	110/400	24	2.19	2.09	96	1.63
S-17077	1 Gal.	4"	110/400	12	\$2.59 any qty.		48	1.82



Super clear storage for dry food, small parts and liquids.

- Wide-mouth opening for easy filling.
- Lightweight, impact-resistant PET.
- FDA compliant.
- Caps included.

CLEAR

SOLD IN CASE QUANTITIES

MODEL NO.	SIZE	OPENING DIAMETER	CAP SIZE	QTY./CASE	PRICE PER JAR		SKID LOTS	
					1 CASE	3+ CASES	QTY.	PRICE/JAR
S-19464	8 oz.	1 13/16"	53/400	36	\$.85	\$.80	2,888	\$.61
S-19465	16 oz.	2 3/16"	63/400	24	1.25	1.20	1,989	.85
S-18075	32 oz.	3 1/4"	89/400	24	1.75	1.65	1,152	1.20
S-18076	1/2 Gal.	4"	110/400	24	2.95	2.80	504	2.00
S-18077	1 Gal.			12	3.85	3.65	224	2.55

# STRAIGHT-SIDED PET JARS New



Clear, impact-resistant jars for trail mix, bath salts and hair gel.

- Flush cap provides a high-end look.
- Super-wide mouth.
- Caps included.

FDA COMPLIANT

SOLD IN CASE QUANTITIES

MODEL NO.	SIZE	OPENING DIAMETER	CAP SIZE	QTY./CASE	PRICE PER JAR		BULK PACKS	
					1 CASE	3+ CASES	QTY.	PRICE/JAR
S-25184	4 oz.	2"	58/400	36	\$.95	\$.90	250	\$.75
S-25185	8 oz.	2 1/4"	70/400	36	1.10	1.05	320	.85
S-25186	16 oz.	3"	89/400	24	1.50	1.40	245	1.15

# DOUBLE WALL DOME JARS

Cosmetic-style jars for expensive moisturizers, creams and pomade.

- Wide mouth for easy filling and product removal.
- FDA compliant.

SPECIFY COLOR: White or Black

MODEL NO.	SIZE	OPENING DIAMETER	CAP SIZE	QTY./CASE	PRICE PER JAR		BULK PACKS	
					1 CASE	3+ CASES	QTY.	PRICE/JAR
S-22464	2 oz.	2"	58/400	48	\$.73	\$.70	360	\$.62
S-22465	4 oz.	2 1/2"	70/400	36	.82	.79	200	.71
S-22466	8 oz.	3 1/4"	89/400	36	1.25	1.20	120	1.05

SOLD IN CASE QUANTITIES

- Chemical-resistant polypropylene.
- Lined caps are included.



# CLEAR ROUND WIDE-MOUTH JARS

SOLD IN CASE QUANTITIES

MODEL NO.	SIZE	OPENING DIAMETER	CAP SIZE	QTY./CASE	PRICE PER JAR		BULK PACKS	
					1 CASE	3+ CASES	QTY.	PRICE/JAR
S-17032	1/4 oz.	1"	33/400	300	\$.32	\$.30	2,200	\$.23
S-17033	1/2 oz.			200	.35	.32	1,800	.24
S-14487	1 oz.	1 1/8"	53/400	72	.39	.37	968	.28
S-12752	2 oz.			48	.46	.44	616	.33
S-17034	3 oz.	2"	58/400	36	.50	.48	480	.37
S-9934	4 oz.			36	.53	.50	350	.38
S-12753	6 oz.	2 1/2"	70/400	36	.62	.58	240	.45
S-9935	8 oz.	3 3/4"	89/400	36	.92	.86	140	.68
S-17035	10 oz.			48	.97	.93	140	.72
S-12754	12 oz.			36	1.03	.98	175	.73
S-9936	16 oz.			24	1.37	1.26	140	.89
S-22855	24 oz.	4 3/8"	120/400	12	1.72	1.61	60	1.38
S-9937	32 oz.			12	2.18	2.07	80	1.61



Instant identification for your parts, liquids or dry goods.

- Super wide mouth for easy filling. Caps included.
- Durable polystyrene meets FDA standards.

Jars Only – Available in Bulk Packs, see [uline.com](http://uline.com)

# WHITE ROUND WIDE-MOUTH JARS

SOLD IN CASE QUANTITIES

MODEL NO.	SIZE	OPENING DIAMETER	CAP SIZE	QTY./CASE	PRICE PER JAR		BULK PACKS	
					1 CASE	3+ CASES	QTY.	PRICE/JAR
S-17036	1/4 oz.	1"	33/400	300	\$.30	\$.28	2,200	\$.22
S-17037	1/2 oz.			200	.32	.30	1,800	.23
S-14504	1 oz.	1 1/8"	53/400	72	.37	.35	968	.27
S-14505	2 oz.			48	.42	.39	616	.30
S-17038	3 oz.	2"	58/400	36	.45	.42	480	.33
S-14506	4 oz.			36	.46	.43	350	.35
S-14507	6 oz.	2 1/2"	70/400	36	.55	.52	240	.40
S-14508	8 oz.	3 3/4"	89/400	36	.85	.81	140	.64
S-17039	10 oz.			48	.92	.86	140	.68
S-14509	12 oz.			36	.97	.93	175	.69
S-14510	16 oz.			24	1.26	1.14	140	.83
S-22856	24 oz.	4 3/8"	120/400	12	1.61	1.49	60	1.32
S-14511	32 oz.			12	2.07	1.95	80	1.52



Excellent for cosmetics, chemicals or nuts and bolts.

- Wide mouth, no inside lip for easy filling and pouring.
- Chemical-resistant polypropylene.
- Caps included. • FDA compliant.

Jars Only – Available in Bulk Packs, see [uline.com](http://uline.com)

# TRANSLUCENT ROUND WIDE-MOUTH JARS

All-purpose jars for powders, creams and small parts.

- Wide mouth for easy filling and pouring.

Black Round Wide-Mouth Jars, see [uline.com](http://uline.com)

FDA COMPLIANT

SOLD IN CASE QUANTITIES

MODEL NO.	SIZE	OPENING DIAMETER	CAP SIZE	QTY./CASE	PRICE PER JAR		BULK PACKS	
					1 CASE	3+ CASES	QTY.	PRICE/JAR
S-23738	2 oz.	1 1/8"	53/400	48	\$.42	\$.39	616	\$.30
S-23739	4 oz.	2"	58/400	36	.46	.43	350	.35
S-23740	8 oz.	3 3/4"	89/400	36	.85	.81	140	.64
S-23741	16 oz.			24	1.26	1.14		.83

- Chemical and impact-resistant polypropylene.
- Caps included.





# PLASTIC SPICE JARS



## UNLINED CAPS

Store sprinkles, sequins or glitter.

- Crystal clear for product visibility.
- Made of durable, lightweight PET.
- Polypropylene shaker caps included.



SPOON AND SIFT CAP OPENINGS

FDA COMPLIANT

SPECIFY CAP COLOR: Black or Red

MODEL NO.	SIZE	CAP SIZE	NO. OF HOLES	QTY./CASE	PRICE PER JAR		BULK PACKS	
					1 CASE	3+ CASES	QTY.	PRICE/JAR
S-20596*	4 oz.	43/485	11	48	\$.66	\$.63	550	\$.50
S-20597	8 oz.	53/485	3	48	.78	.74	400	.62
S-20598	16 oz.	63/485	5	24	1.10	1.05	272	.85

\* Flip and sift cap

SOLD IN CASE QUANTITIES



## LINED CAPS

Seal in freshness.

- Crystal clear to showcase spices and BBQ rubs.
- Made of durable, lightweight PET.
- Polypropylene shaker caps with pressure-sensitive liner.



SPOON AND SIFT CAP OPENINGS

FDA COMPLIANT

CAP COLOR: Black

MODEL NO.	SIZE	CAP SIZE	NO. OF HOLES	QTY./CASE	PRICE PER JAR		BULK PACKS	
					1 CASE	3+ CASES	QTY.	PRICE/JAR
S-25253*	4 oz.	43/485	11	48	\$.71	\$.68	550	\$.53
S-25254	8 oz.	53/485	3	48	.83	.79	400	.64
S-25255	16 oz.	63/485	5	24	1.18	1.13	272	.90

\* Flip and sift cap

SOLD IN CASE QUANTITIES

# PLASTIC JUICE BOTTLES



## CLEAR

Juices, smoothies and teas look better in these crystal clear bottles.

- Durable, lightweight PET.
- Tamper-evident polyethylene caps included.

FDA COMPLIANT

SOLD IN CASE QUANTITIES

MODEL NO.	SIZE	OPENING DIAM.	CAP SIZE	QTY./CASE	PRICE PER BOTTLE		BULK PACKS	
					1 CASE	3+ CASES	QTY.	PRICE/BTL.
S-21725	8 oz.	1 1/8"	38/ Juice	36	\$.82	\$.78	300	\$.61
S-21726	12 oz.			36	.86	.82	200	.64
S-21727	16 oz.			24	.91	.86	150	.67
S-22930	32 oz.			24	1.35	1.20	75	1.05



## NATURAL

Classic, handheld bottles for flavored milks, protein drinks and creamers.

- Durable, lightweight HDPE.
- Tamper-evident polyethylene caps included.

FDA COMPLIANT

SOLD IN CASE QUANTITIES

MODEL NO.	SIZE	OPENING DIAM.	CAP SIZE	QTY./CASE	PRICE PER BOTTLE		BULK PACKS	
					1 CASE	3+ CASES	QTY.	PRICE/BTL.
S-24127	8 oz.	1 1/8"	38/400	96	\$.37	\$.34	864	\$.27
S-24128	12 oz.			48	.48	.45	600	.35
S-24129	16 oz.			48	.53	.50	480	.40

# COSMO BOTTLES



## STANDARD CAPS

Soft-shoulder look for sparkling water, body cream and personal care products.

- Lightweight, shatterproof PET.
- Standard ribbed white caps included.

FDA COMPLIANT

SOLD IN CASE QUANTITIES

MODEL NO.	SIZE	OPENING DIAM.	CAP SIZE	QTY./CASE	PRICE PER BOTTLE		BULK PACKS	
					1 CASE	3+ CASES	QTY.	PRICE/BTL.
S-24581	4 oz.	1 1/16"	24/410	48	\$.50	\$.47	550	\$.37
S-24582	8 oz.			36	.65	.61	336	.52
S-24583	16 oz.			24	1.01	.95	189	.82



## DISC TOP CAPS

Sleek and attractive design for dispensing lotions, shampoos and astringents.

- Lightweight, shatterproof PET.
- Black disc top caps open easily with one hand.



FDA COMPLIANT

SOLD IN CASE QUANTITIES

MODEL NO.	SIZE	OPENING DIAM.	CAP SIZE	QTY./CASE	PRICE PER BOTTLE		BULK PACKS	
					1 CASE	3+ CASES	QTY.	PRICE/BTL.
S-24584	4 oz.	1 1/16"	24/410	48	\$.79	\$.74	550	\$.62
S-24585	8 oz.			36	.89	.84	336	.70
S-24586	16 oz.			24	1.25	1.15	189	.99

# CYLINDER BOTTLES

**BULK PACKS – SAVE UP TO 25%**



Store/dispense liquids with these refillable containers.

- For use in cosmetics, pharmaceuticals and laboratories.
- Made of translucent, impact-resistant HDPE.
- White, see uline.com

## NATURAL

MODEL NO.	SIZE	OPENING DIAMETER	CAP SIZE	QTY./ CASE	PRICE PER BOTTLE		BULK PACKS	
					1 CASE	3+ CASES	QTY.	PRICE/BTL.
S-20071	1 oz.	9/16"	20/410	72	\$.38	\$.36	1,500	\$.28
S-20072	2 oz.			60	.31	.29	900	.25
S-20073	4 oz.	11/16"	24/410	48	.40	.38	500	.30
S-20074	8 oz.			36	.49	.46	336	.37
S-20075	16 oz.	13/16"	28/400	24	.64	.60	189	.49
S-20076	32 oz.			12	1.03	.96	100	.79

Flip-top caps, see uline.com

FDA COMPLIANT



Crystal clear for product visibility.

- Use for shampoos, lotions and cleaners.
- Shaped for labeling.
- Made of durable, lightweight PET.

## CLEAR

MODEL NO.	SIZE	OPENING DIAMETER	CAP SIZE	QTY./ CASE	PRICE PER BOTTLE		BULK PACKS	
					1 CASE	3+ CASES	QTY.	PRICE/BTL.
S-21128	1 oz.			72	\$.37	\$.35	920	\$.26
S-19466	2 oz.	9/16"	20/410	60	.42	.40	625	.32
S-18120	4 oz.			48	.55	.52	450	.41
S-18121	8 oz.	3/4"	24/410	36	.71	.67	360	.57
S-18122	12 oz.			36	.94	.88	210	.77
S-18123	16 oz.	7/8"	28/410	24	1.11	1.04	186	.90

Flip-top caps, see uline.com

FDA COMPLIANT

# CYLINDER SPRAY BOTTLES

## NATURAL

Refillable, fine mist sprayers for chemicals and cleaners.

- Use in pharmaceuticals and laboratories.
- Translucent HDPE bottles with fingertip mister.



## CLEAR

Convenient travel size for hair spray, body mist and astringent.

- Use in boutiques, salons and households.
- Crystal clear, lightweight PET with fingertip mister.



FDA COMPLIANT BOTTLES

SOLD IN CASE QUANTITIES

MODEL NO.	SIZE	OUTPUT (mL)	CAP SIZE	QTY./ CASE	PRICE PER BOTTLE		BULK PACKS	
					1 CASE	3+ CASES	QTY.	PRICE/BTL.
S-20077	2 oz.			48	\$.84	\$.79	900	\$.56
S-20078	4 oz.	0.25	24/410	48	.96	.89	500	.60
S-20079	8 oz.			24	1.08	1.01	336	.67

FDA COMPLIANT BOTTLES

SOLD IN CASE QUANTITIES

MODEL NO.	SIZE	OUTPUT (mL)	CAP SIZE	QTY./ CASE	PRICE PER BOTTLE		BULK PACKS	
					1 CASE	3+ CASES	QTY.	PRICE/BTL.
S-21661	2 oz.		20/410	48	\$.79	\$.74	625	\$.52
S-21662	4 oz.	0.14	20/410	48	.89	.84	450	.57
S-21663	8 oz.		24/410	24	.99	.94	360	.68

# SQUEEZABLE BOTTLES

## BOSTON ROUND

Dispense precise amounts of adhesives, dyes and paints.

- Soft, translucent LDPE bottles with Yorker cap.
- Suitable for dropper applications.



## CYLINDER

Dispense sauces and condiments.

- Soft, easy-to-squeeze LDPE bottles with Yorker cap.
- Wide mouth for easy filling.
- Shaped for easy labeling.
- Jumbo 32 oz. size for BBQ pros.



FDA COMPLIANT

SOLD IN CASE QUANTITIES

MODEL NO.	SIZE	TIP DIAM.	CAP SIZE	QTY./ CASE	PRICE PER BOTTLE		BULK PACKS	
					1 CASE	3+ CASES	QTY.	PRICE/BTL.
S-17040	2 oz.		18/410	60	\$.84	\$.80	950	\$.63
S-17041	4 oz.	.03"	24/410	50	1.01	.94	581	.74
S-17042	8 oz.		24/410	32	1.79	1.69	268	1.26
S-17043	16 oz.		28/400	25	2.25	2.11	140	1.58

FDA COMPLIANT

SOLD IN CASE QUANTITIES

MODEL NO.	SIZE	TIP DIAM.	CAP SIZE	QTY./ CASE	PRICE PER BOTTLE		BULK PACKS	
					1 CASE	3+ CASES	QTY.	PRICE/BTL.
S-18124	8 oz.			36	\$.96	\$.90	528	\$.79
S-18125	12 oz.	.09"	38/400	36	1.07	1.00	324	.86
S-18126	16 oz.			36	1.28	1.20	243	.95
S-19467	32 oz.			12	1.84	1.72	112	1.36

# PLASTIC GRIP JARS



IN STOCK - SHIPS TODAY

- Virtually unbreakable, lightweight PET. Soft drink bottle material.
- Square body shape for efficient storing or shipping.
- Caps included. • FDA compliant.

Side indents allow for easy pouring and dispensing.

- Fill, store and pour dry food or industrial products.

SOLD IN CASE QUANTITIES

MODEL NO.	SIZE	OPENING DIAM.	CAP SIZE	QTY./CASE	PRICE PER JAR		SKID LOTS	
					1 CASE	3+ CASES	QTY.	PRICE/JAR
S-17075	16 oz.	2 1/4"	63/400	48	\$1.09	\$.99	1,950	\$.80
S-19294	32 oz.	3 1/2"	89/400	36	1.69	1.59	1,080	1.20
S-15709	48 oz.	3 1/4"	89/400	36	1.99	1.89	756	1.40
S-15710	1/2 Gal.	4"	110/400	24	2.59	2.39	480	1.90
S-15711	1 Gal.	4"	110/400	12	3.89	3.59	256	2.80



CLEAR

CAPS INCLUDED

## BOSTON ROUND BOTTLES

Show off your shampoos, conditioners and oils.

- Virtually unbreakable PET plastic. Light and durable.
- Easy grip, easy pouring bottles.

Durable packaging for lotions, soaps and cosmetics.

- Lightweight, shatter-resistant HDPE.
- Narrow mouth opening for easy pouring.



NATURAL

CAPS INCLUDED

FDA COMPLIANT SOLD IN CASE QUANTITIES

MODEL NO.	SIZE (OZ.)	OPENING DIAM.	CAP SIZE	QTY./CASE	PRICE PER BOTTLE		BULK PACKS	
					1 CASE	3+ CASES	QTY.	PRICE/BTL.
S-21696	8	3/4"	24/410	36	\$.80	\$.74	280	\$.59
S-21697	16	7/8"	28/410	36	1.07	1.01	144	.77
S-21698	32			24	1.32	1.22	80	.99

FDA COMPLIANT SOLD IN CASE QUANTITIES

MODEL NO.	SIZE (OZ.)	OPENING DIAM.	CAP SIZE	QTY./CASE	PRICE PER BOTTLE		BULK PACKS	
					1 CASE	3+ CASES	QTY.	PRICE/BTL.
S-17976	8	3/4"	24/410	36	\$.71	\$.67	400	\$.54
S-17977	16	7/8"	28/410	36	1.01	.96	196	.70
S-17978	32			24	1.24	1.13	108	.89

## PLASTIC SAUCE BOTTLES



BANJO RING NECK

Feeling saucy? Dispense BBQ sauce, marinades and dressings.

- Made of durable, lightweight PET.
- Crystal clear for product visibility.
- Polypropylene caps included.

FDA COMPLIANT SOLD IN CASE QUANTITIES

MODEL NO.	DESC.	SIZE (OZ.)	CAP SIZE	QTY./CASE	PRICE PER BOTTLE		BULK PACKS	
					1 CASE	3+ CASES	QTY.	PRICE/BTL.
S-24633	Banjo	16	38/400	36	\$1.00	\$.95	425	\$.75
S-24632	Ring Neck	12	38/400	36	1.10	1.05	162	.85

■ BULK PACK SHIPS VIA MOTOR FREIGHT

## PLASTIC HONEY BOTTLES

Create a buzz with these squeezable honey bottles.

- Made of durable, lightweight PET.
- Crystal clear for product visibility.
- Includes flip-top caps with pressure-sensitive liner.



22 OZ. 12 OZ. 8 OZ.

FDA COMPLIANT SOLD IN CASE QUANTITIES

MODEL NO.	SHAPE	SIZE (OZ.)	CAP SIZE	QTY./CASE	PRICE PER BOTTLE		BULK PACKS	
					1 CASE	3+ CASES	QTY.	PRICE/BTL.
S-24634	Bear	8			\$1.00	\$.95	285	\$.75
S-24635	Oval	12	38/400	36	1.05	1.00	225	.80
S-24636	Oval	22			1.45	1.35	120	1.10



# WIDE-MOUTH GLASS JARS



FDA COMPLIANT

SOLD IN CASE QUANTITIES

MODEL NO.	SIZE	OPENING DIAMETER	CAP SIZE	QTY./CASE	PLASTIC CAP		METAL CAP	
					1 CASE	3+ CASES	1 CASE	3+ CASES
S-20558	2 oz.	1 1/8"	38/400	48	\$.80	\$.70	\$1.05	\$.95
S-14488	4 oz.	1 1/2"	48/400	24	.90	.80	1.10	1.00
S-12755	8 oz.	1 7/8"	58/400	24	1.05	.95	1.30	1.20
S-17074	12 oz.	2 1/4"	70/450	12	1.25	1.15	1.65	1.55
S-23539	16 oz.	2 1/4"	70/450	12	1.35	1.25	1.75	1.65
S-12757	32 oz.	2 1/4"	70/400	12	1.85	1.75	2.25	2.15
S-14489	1/2 Gal.	2 3/4"	83/400	6	2.95	2.80	3.60	3.45
S-12758	1 Gal.	3"	89/400	4	4.60	4.40	5.40	5.15
S-19317	1 Gal.	4"	110/400	4	4.70	4.50	5.50	5.25

Crystal-clear storage for dry or liquid food products.

- Wide mouth for easy pouring and filling.
- Plastic caps for general use. Metal caps for food.
- Plastic or metal caps included.

## GLASS SAUCE BOTTLES



Display your sauces and marinades.

- Crystal clear sauce bottles to dazzle restaurateurs and executive chefs.
- **Ring Neck** – Tapered design for easy pouring.
- **Marasca** – Slim design with high-sloped shoulders.
- Black polypropylene caps are included.

FDA COMPLIANT

SOLD IN CASE QUANTITIES

MODEL NO.	DESCRIPTION	SIZE (OZ.)	OPENING DIAM.	CAP SIZE	QTY./CASE	PRICE PER BOTTLE	
						1 CASE	3+ CASES
S-24560	Ring Neck	12	1 1/8"	38/400	12	\$1.10	\$1.05
S-24561	Marasca	8	13/16"	28/400		1.15	1.10

## GLASS WOOLY BOTTLES

Some like it hot. Bottle your own heat.

- Plastic insert for controlled pouring or drizzling.
- Crystal clear so you can tell spicy from mild.
- Black or red polypropylene caps included.
- Plastic Wooly Bottles available, see [uline.com](http://uline.com)



FDA COMPLIANT

SPECIFY CAP COLOR: Black or Red

MODEL NO.	SIZE	OPENING DIAMETER	CAP SIZE	QTY./CASE	PRICE PER BOTTLE	
					2 CASES	4+ CASES
S-21720	5 oz.	9/16"	24/414	12	\$.85	\$.80
S-21721	10 oz.				1.20	1.10

SOLD IN CASE QUANTITIES

## GLASS CANNING JARS



Preserve your fruits, vegetables and sauces in these glass jars.

- Tin plated, vacuum seal lid keeps foods fresh.
- Withstands temperatures up to 250°F. FDA compliant.

**Ball®** – Like grandma used to use. For country stores and home canning.

**Standard** – Smooth sides for labeling. For canneries and store brands.



**BALL®** – Regular Mouth

SOLD IN CASE QUANTITIES

MODEL NO.	SIZE	CAPACITY	OPENING DIAMETER	QTY./CASE	PRICE PER JAR	
					1 CASE	3+ CASES
S-19695	Quarter Pint	4 oz.			\$1.70	\$1.60
S-17490	Half Pint	8 oz.			1.70	1.60
S-17491	Pint	16 oz.	2 3/8"	12	1.90	1.80
S-17492	Quart	32 oz.			2.00	1.90

Additional sizes and skid lots, see [uline.com](http://uline.com)

**STANDARD** – Regular Mouth

SOLD IN CASE QUANTITIES

MODEL NO.	SIZE	CAPACITY	OPENING DIAMETER	QTY./CASE	PRICE PER JAR	
					1 CASE	3+ CASES
S-22931	Half Pint	8 oz.			\$1.20	\$1.10
S-22932	Pint	16 oz.			1.50	1.40
S-22933	1.5 Pint	24 oz.	2 3/8"	12	1.70	1.60
S-22934	Quart	32 oz.			1.80	1.65

# BOSTON ROUND GLASS BOTTLES



Store and pour chemicals and medicines.

- Narrow mouth for precision pouring.
- Phenolic black caps included.

**Clear** – Maximum product visibility.

**Amber** – Safe storage for hydrogen peroxide, sulfuric acid and light-sensitive chemicals.



## CLEAR SOLD IN CASE QUANTITIES

MODEL NO.	SIZE	OPENING DIAMETER	CAP SIZE	COLOR	QTY./CASE	PRICE PER BOTTLE	
						1 CASE	3+ CASES
S-24131	1/2 oz.	7/16"	18/400	Clear	48	\$.75	\$.65
S-20886	1 oz.	1/2"	20/400		48	.80	.70
S-20887	2 oz.	1/2"	20/400		48	.90	.80
S-17985	4 oz.	9/16"	22/400	Clear	24	1.00	.90
S-23397	8 oz.	11/16"	28/400		12	1.40	1.25
S-18031	16 oz.	3/4"	28/400	Clear	12	1.65	1.50
S-18032	32 oz.	15/16"	33/400		12	2.50	2.25

FDA COMPLIANT

## AMBER SOLD IN CASE QUANTITIES

MODEL NO.	SIZE	OPENING DIAMETER	CAP SIZE	COLOR	QTY./CASE	PRICE PER BOTTLE	
						1 CASE	3+ CASES
S-24132	1/2 oz.	7/16"	18/400	Amber	48	\$.75	\$.65
S-20888	1 oz.	1/2"	20/400		48	.80	.70
S-20889	2 oz.	1/2"	20/400		48	.90	.80
S-15649	4 oz.	9/16"	22/400	Amber	24	1.00	.90
S-23396	8 oz.	11/16"	28/400		12	1.40	1.25
S-15651	16 oz.	3/4"	28/400	Amber	12	1.65	1.50
S-15652	32 oz.	15/16"	33/400		12	2.50	2.25

FDA COMPLIANT

# AMBER WIDE-MOUTH GLASS JARS



Store tablets, powders and light-sensitive materials.

- Wide mouth for easy access to contents.
- Phenolic black caps included.

FDA COMPLIANT

SOLD IN CASE QUANTITIES

MODEL NO.	SIZE	OPENING DIAMETER	CAP SIZE	QTY./CASE	PRICE PER JAR	
					1 CASE	3+ CASES
S-21719	2 oz.	1"	33/400	24	\$1.10	\$1.00
S-20590	4 oz.	1 1/8"	38/400	24	1.25	1.15
S-20591	8 oz.	1 3/8"	45/400	24	1.55	1.45
S-20592	16 oz.	1 5/8"	53/400	12	2.20	2.10
S-20593	32 oz.	1 7/8"	53/400	12	2.70	2.60

# FRENCH SQUARE GLASS JARS



For gourmet sauces, herbs and marinades.

- Wide-mouth opening with stylish, rounded corners.
- FDA compliant.

- Thick-walled, durable construction.
- White or black polypropylene caps included.



SPECIFY CAP COLOR: White or Black

SOLD IN CASE QUANTITIES

MODEL NO.	SIZE	OPENING DIAMETER	CAP SIZE	QTY./CASE	PRICE PER JAR	
					1 CASE	3+ CASES
S-25198	2 oz.	11/16"	28/400	36	\$1.00	\$.90
S-21738	4 oz.	15/16"	33/400	24	1.20	1.10
S-21739	8 oz.	1 1/4"	43/400	24	1.75	1.65
S-21740	16 oz.	1 1/2"	48/400	12	2.40	2.20

# GLASS JUGS



Bulk storage for juices, ciders and craft beers.

- Finger handle for easy carrying and pouring.
- FDA compliant.

**Crystal Clear** – For visibility. Phenolic black caps included.

**Amber Growler** – For take-home tap beers. White metal caps included.



SOLD IN CASE QUANTITIES

MODEL NO.	SIZE	OPENING DIAMETER	CAP SIZE	COLOR	QTY./CASE	PRICE PER JUG	
						1 CASE	3+ CASES
S-18033C	1/2 Gal.	1 1/8"	38/400	Clear	6	\$4.15	\$3.95
S-18034	1 Gal.	1 1/8"	38/400		4	7.40	7.10
S-18033A	1/2 Gal.	1 1/8"	38/400	Amber	6	4.85	4.60

# CLEAR STRAIGHT-SIDED GLASS JARS

## JARS WITH PLASTIC CAP

SPECIFY CAP COLOR: White or Black

MODEL NO.	SIZE	OPENING DIAMETER	CAP SIZE	QTY./ CASE	PRICE PER JAR	
					1 CASE	3+ CASES
S-17073P	1 oz.	1¼"	43/400	48	\$.90	\$.80
S-15846P	2 oz.	1½"	53/400	24	.95	.85
S-17982P	4 oz.	1¾"	58/400	24	1.05	.95
S-15847P	6 oz.	2⅛"	63/400	24	1.10	1.00
S-17983P	8 oz.	2⅜"	70/400	24	1.35	1.25
S-22916P	12 oz.	2¾"	83/400	12	1.50	1.40
S-17984P	16 oz.	3"	89/400	12	1.65	1.55
S-19316P	32 oz.	3"	89/400	12	2.20	2.10



## JARS WITH METAL CAP

SPECIFY CAP COLOR: White, Black or Gold

MODEL NO.	SIZE	OPENING DIAMETER	CAP SIZE	QTY./ CASE	PRICE PER JAR	
					1 CASE	3+ CASES
S-17073M	1 oz.	1¼"	43/400	48	\$1.10	\$1.00
S-15846M	2 oz.	1½"	53/400	24	1.20	1.10
S-17982M	4 oz.	1¾"	58/400	24	1.25	1.15
S-15847M	6 oz.	2⅛"	63/400	24	1.30	1.20
S-17983M	8 oz.	2⅜"	70/400	24	1.70	1.60
S-22916M	12 oz.	2¾"	83/400	12	1.90	1.80
S-17984M	16 oz.	3"	89/400	12	2.15	2.05
S-19316M	32 oz.	3"	89/400	12	2.70	2.60

Sleek, clear jar for cosmetics or creams.

- Straight walls for easy filling and access to contents.
- Sold in case quantities. FDA compliant.

## JARS WITH CAPS

Jars and caps come perfectly paired.

**Plastic Cap** – General purpose use.

**Metal Cap** – For food storage.



## JARS ONLY

MODEL NO.	SIZE	OPENING DIAMETER	CAP SIZE	QTY./ CASE	PRICE PER JAR	
					1 CASE	3+ CASES
S-25161	1 oz.	1¼"	43/400	384	\$.80	\$.70
S-25162	2 oz.	1½"	53/400	24	.85	.75
S-25163	4 oz.	1¾"	58/400	24	.90	.80
S-25164	6 oz.	2⅛"	63/400	24	1.00	.90
S-25165	8 oz.	2⅜"	70/400	24	1.20	1.10
S-25166	12 oz.	2¾"	83/400	12	1.25	1.15
S-25167	16 oz.	3"	89/400	12	1.35	1.25
S-25168	32 oz.	3"	89/400	12	1.85	1.75

## JARS ONLY

Jars go straight into your automatic filling system.

- For fast and efficient packaging.
- Top off products with your own sealing solution.
- Plastic and metal caps, see [uline.com](http://uline.com)



# AMBER STRAIGHT-SIDED GLASS JARS

## JARS WITH PHENOLIC CAP

MODEL NO.	SIZE	OPENING DIAMETER	CAP SIZE	QTY./ CASE	PRICE PER JAR	
					1 CASE	3+ CASES
S-24531	2 oz.	1½"	53/400	24	\$1.25	\$1.15
S-24532	4 oz.	1¾"	58/400	24	1.30	1.20
S-24533	8 oz.	2⅜"	70/400	24	1.80	1.70

Safely store light-sensitive chemicals or pharmaceuticals.

- Straight walls for easy access to contents.
- Sold in case quantities. FDA compliant.

## JARS WITH METAL CAP

MODEL NO.	SIZE	OPENING DIAMETER	CAP SIZE	QTY./ CASE	PRICE PER JAR	
					1 CASE	3+ CASES
S-25205	2 oz.	1½"	53/400	24	\$1.20	\$1.10
S-25206	4 oz.	1¾"	58/400	24	1.25	1.15
S-25207	8 oz.	2⅜"	70/400	24	1.70	1.60

**Phenolic Cap** – Multipurpose. For general applications.

**Metal Cap** – For vitamins and cosmetics.





# TEST TUBES AND RACKS

**Borosilicate Glass:** Withstands repeated sterilizations, temps up to 950°F, harsh chemicals and thermal shock from sudden temperature changes.

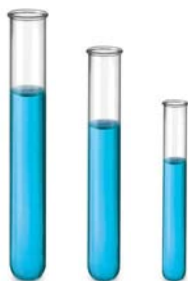

Conduct experiments in chemical testing and research labs.

- Crystal clear **borosilicate** glass with chip-resistant rim.
- Withstands direct flame and temps up to 950°F.
- Easy to clean. Autoclavable. • FDA compliant.

**Racks** – Keep samples secure and organized as you work. Excellent for use in water baths. Autoclavable. Ships flat, assembles in seconds.

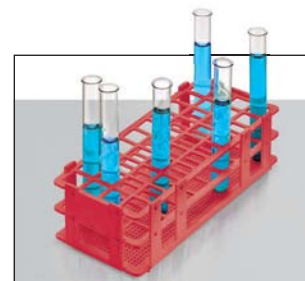

## TEST TUBES

SOLD IN CASE QUANTITIES

MODEL NO.	SIZE	DIMENSIONS DIAM. x L	OPENING DIAMETER	QTY./ CASE	PRICE PER CASE		
					1	3	10+
S-25236	8 mL	12 x 100 mm	11 mm	100	\$40	\$38	\$35
S-25264	16 mL	16 x 125 mm	13.8 mm		62	59	55
S-25265	25 mL	18 x 150 mm	16.8 mm		67	64	60
S-25266	50 mL	24 x 150 mm	22.8 mm		94	90	84

## TEST TUBE RACKS

SPECIFY COLOR: White or Red

MODEL NO.	MAX. TEST TUBE DIAMETER	RACK CAPACITY	DIMENSIONS L x W x H	PRICE EACH	
				1	6+
S-25267	13 mm	90	9 3/4 x 4 x 2 3/4"	\$22	\$20
S-25268	16 mm	60			
S-25269	20 mm	40			
S-25270	25 mm	24			

# GLASS BEAKERS



Used in all labs – schools, medical and industrial.

- Crystal clear, strong **borosilicate** glass. Autoclavable.
- Tapered spout for smooth pouring.
- Graduated for accurate measurement.

Meets ASTM E960

MODEL NO.	SIZE	GRADUATION INCREMENTS	OPENING DIAMETER	QTY./ CASE	PRICE PER CASE	
					1	3+
S-25271	100 mL	25 mL	2"	12	\$31	\$29
S-25272	250 mL	50 mL	2 1/2"		40	38
S-25274	1,000 mL	100 mL	4"		6	58

SOLD IN CASE QUANTITIES

# GLASS VIALS

Store and transport samples from one site to another.

- Super high clarity **borosilicate** glass.
- Polypropylene cap with PTFE liner. Autoclavable.



**Clear** – Unobstructed product visibility.

**Amber** – Protect light-sensitive contents.

FDA COMPLIANT

SPECIFY COLOR: Clear or Amber

MODEL NO.	SIZE	OPENING DIAMETER	CAP SIZE	QTY./ CASE	PRICE PER CASE	
					1	3+
S-25275	5 mL	0.4"	15/415	24	\$24	\$22
S-25276	15 mL	0.6"	22/415		30	28
S-25277	30 mL	0.6"	22/415		34	32

SOLD IN CASE QUANTITIES

# TRANSFER PIPETTES



Transfer fluids to sample tubes one drop at a time.

- Squeezable and flexible LDPE plastic. Non-sterile.
- Disposable to prevent cross-contamination.

- Graduated for accurate measurement.

SOLD IN CARTON QUANTITIES

MODEL NO.	SIZE	GRADUATION RANGE	GRADUATION INCREMENTS	QTY./ CTN.	PRICE PER CARTON		
					1	3	10+
S-24318	3 mL	0.25 - 1 mL	0.25 mL	500	\$32	\$30	\$28
S-24319	5 mL						
S-24320	7 mL	0.50 - 3 mL	0.50 mL				

# SAFETY WASH BOTTLES

Quickly clean out vials, test tubes and beakers.

- Angled nozzle for perfect slim fit.
- Safety labels for hazard identification.

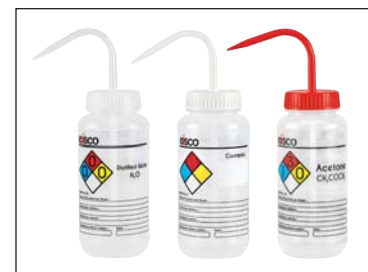

**Label-Your-Own** – Write in contents and safety information.

Meets GHS Standards

SOLD IN PACK QUANTITIES

MODEL NO.	DESCRIPTION	SIZE	CAP COLOR	QTY./ PACK	PRICE PER PACK	
					1	3+
S-25278	Distilled Water	500 mL	Natural	6	\$54	\$48
S-25279	Label-Your-Own		White			
S-25280	Acetone		Red			

# GLASS DROPPER BOTTLES

Precisely dispense oils, medicines and extracts one drop at a time.

- Bottle includes glass dropper with attached black polypropylene cap.

**Graduated** – Dropper marked at 0.25 mL intervals up to 1 mL.

FDA COMPLIANT

SPECIFY COLOR: Clear or Amber

MODEL NO.	DESCRIPTION	SIZE	OPENING DIAMETER	CAP SIZE	QTY./CASE	PRICE PER BOTTLE	
						1 CASE	3+ CASES
S-20604*	Standard	1/2 oz.	7/16"	18/400	48	\$ .95	\$.85
S-20037*		1 oz.	1/2"	20/400	48	1.00	.90
S-20038*		2 oz.	1/2"	20/400	24	1.15	1.05
S-20039*		4 oz.	9/16"	22/400	24	1.35	1.25
S-24308	Graduated	1/2 oz.	7/16"	18/400	48	1.00	.90
S-24309		1 oz.	1/2"	20/400	48	1.05	.95
S-24310		2 oz.	1/2"	20/400	24	1.20	1.10
S-24311		4 oz.	9/16"	22/400	24	1.40	1.30

\*Also available in Blue

SOLD IN CASE QUANTITIES



Clear – For easy product visibility.  
Amber – Ultimate UV protection.  
Blue – Vivid color with UV protection.

# GLASS SPRAY BOTTLES



Deliver a quick spritz of perfumes and oils.

- Use in salons, spas and laboratories.
- Fingertip mister and clear overcap.
- FDA compliant bottles.

**Clear** – High clarity for easy product visibility.

**Amber** – Protects light-sensitive contents.

SPECIFY COLOR: Clear or Amber

MODEL NO.	SIZE	OUTPUT (mL)	CAP SIZE	QTY./CASE	PRICE PER BOTTLE	
					1 CASE	3+ CASES
S-24562	2 oz.	0.15	20/400	24	\$1.00	\$.90
S-24563	4 oz.		22/400		1.10	1.00
S-24564	8 oz.		28/400		1.50	1.35

SOLD IN CASE QUANTITIES

# GLASS PUMP BOTTLES New

Classic containers for soaps and sanitizers.

- Popular selection for upscale salon and medspa products.
- Includes dip tube and polypropylene pump.
- FDA compliant bottles.

**Clear** – Provides maximum product visibility.

**Amber** – Protects light-sensitive contents.



SPECIFY COLOR: Clear or Amber

MODEL NO.	SIZE	OUTPUT (mL)	CAP SIZE	QTY./CASE	PRICE PER BOTTLE	
					1 CASE	3+ CASES
S-25124	8 oz.	2	28/400	24	\$1.50	\$1.35
S-25125	16 oz.				1.75	1.60

SOLD IN CASE QUANTITIES

# PACKER BOTTLES



WHITE

Wide mouth for easy filling of tablets and capsules.

- For pharmaceuticals and nutritional supplements.
- Lightweight and durable HDPE bottle.
- Caps included.

FDA COMPLIANT

SOLD IN CASE QUANTITIES

MODEL NO.	SIZE (OZ.)	OPENING DIAM.	CAP SIZE	QTY./CASE	PRICE PER BOTTLE		BULK PACKS	
					1 CASE	3+ CASES	QTY.	PRICE/BTL.
S-22896	2	1"	33/400	72	\$.38	\$.36	850	\$.27
S-22897	4	1 1/4"	38/400	60	.44	.41	510	.33
S-22898	8	1 1/2"	45/400	48	.66	.63	280	.49
S-22899	16	1 3/4"	53/400	36	.97	.92	140	.79

Crystal-clear packaging for vitamins and supplements.

- Wide-mouth opening for easy filling.
- Lightweight, impact-resistant PET.
- Caps included.



CLEAR

FDA COMPLIANT

SOLD IN CASE QUANTITIES

MODEL NO.	SIZE (OZ.)	OPENING DIAM.	CAP SIZE	QTY./CASE	PRICE PER BOTTLE		BULK PACKS	
					1 CASE	3+ CASES	QTY.	PRICE/BTL.
S-24548	2	1"	33/400	72	\$.48	\$.45	775	\$.36
S-24549	4	1 1/4"	38/400	60	.53	.50	450	.41
S-24550	8	1 1/2"	45/400	48	.74	.70	335	.58
S-24551	16	1 3/4"	53/400	36	1.25	1.17	140	.98

# MOBILE DRY ERASE BOARDS

Rolling two-sided whiteboard lets you brainstorm in any meeting room.



- Double the writing space with a simple flip of the board.
- **Nonmagnetic** – White melamine surface resists scratching.
- **Magnetic** – Doubles as dry erase and magnetic bulletin board.
- Aluminum frame and stand with full-length marker tray.
- Easy glide 2" nylon swivel casters, 2 locking.

MODEL NO.	DESCRIPTION	SIZE W x H	TOTAL HEIGHT	WT. (LBS.)	PRICE EACH	
					1	3+
H-3954	Nonmagnetic Melamine	4 x 3'	72"	45	\$555	\$535
H-3955		6 x 4'	78"	80	675	645
H-7178	Magnetic Steel	4 x 3'	72"	50	615	595
H-7179		6 x 4'	78"	83	815	785
H-7804		8 x 4'	78"	82	1,260	1,200
H-4575	Magnetic Porcelain	4 x 3'	72"	52	645	615
H-4576		6 x 4'	78"	86	875	835
H-5859		8 x 4'	78"	90	1,370	1,310

SHIPS UNASSEMBLED VIA MOTOR FREIGHT

# GLASS DRY ERASE BOARDS

Frameless glass boards are easy to clean and last forever!

- Tempered glass will not ghost or stain.
- Doubles as a magnetic bulletin board.

**White** – Includes 4 markers, tray and mounting hardware.

**Colored** – Adds a vibrant pop to trendy urban offices and restaurants. Includes 5 neon markers, tray and hardware.

**Neon Markers** – Make a statement. Includes one of each: Pink, Orange, Yellow, Green and Blue.



SPECIFY COLOR: Black Blue Green

MODEL NO.	DESCRIPTION	SIZE W x H	WT. (LBS.)	PRICE EACH	
				1	3+
H-7180	Magnetic White	4 x 3'	42	\$280	\$260
H-7181		6 x 4'	79	545	515
H-7805		8 x 4'	102	710	670

SHIPS VIA MOTOR FREIGHT

MODEL NO.	DESCRIPTION	SIZE W x H	WT. (LBS.)	PRICE EACH	
				1	3+
H-7806	Magnetic Colored	4 x 3'	42	\$300	\$280
H-7807		6 x 4'	79	595	565
S-22783*	Expo® Assorted Neon Markers			13	12

\*SHIPS VIA UPS

SHIPS VIA MOTOR FREIGHT

# FABRIC BULLETIN BOARDS

Post important company announcements and office safety notices in style.

- Use push pins or magnets. Long-lasting fabric hides pin holes.
- Sleek aluminum frame with high-density fiberboard back.



MODEL NO.	DESCRIPTION	SIZE W x H	WT. (LBS.)	PRICE EACH	
				1	3+
H-7809	Magnetic	4 x 3'	18	\$305	\$295
H-7810		6 x 4'	39	640	620

SHIPS VIA MOTOR FREIGHT

# EXPO® DRY ERASE MARKERS

Chisel tip for your choice of fine or bold writing.

- Erases easily with cloth or dry eraser.
- Nontoxic ink. Low odor.



\* SPECIFY COLOR: Black, Blue, Green or Red

MODEL NO.	DESCRIPTION	COLOR	QTY./ BOX	PRICE PER BOX	
				1	3+
H-748*	Expo®	Specify Color	12	\$23	\$22
H-2759		Assortment Pack	4	8	7

# EXPO® DRY ERASE CLEANERS

Make dry erase surfaces sparkle.

**Eraser** – Quickly wipes dry erase boards clean.

**Spray** – Nontoxic. Just spray and wipe.



MODEL NO.	DESCRIPTION	SIZE	PRICE EACH	
			1	3+
H-1458	Eraser	5 x 3 x 2"	\$3.65	\$3.40
S-17469	Spray	22 oz.	10.75	10.25



# CORK BOARDS

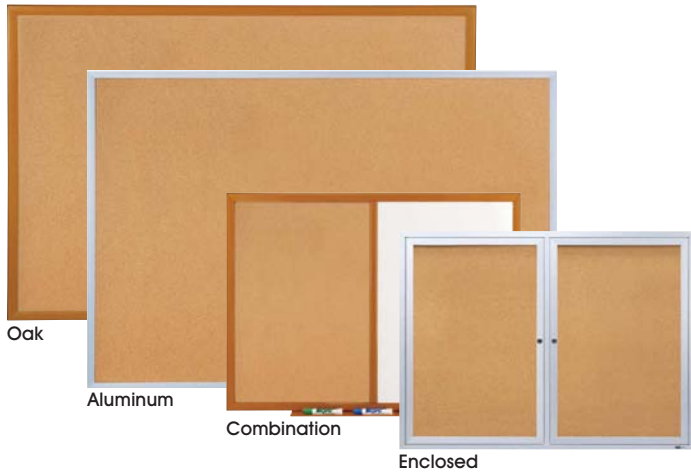

Keep employees informed of bulletins and announcements.

**Aluminum Frame** – Heavy-gauge frame with a contemporary, satin finish.

**Oak Frame** – Wood veneer frame. A stylish, classic look.

**Combination** – Dry erase and cork board surfaces. Nonmagnetic melamine surface resists scratching.

MODEL NO.	DESCRIPTION	SIZE W x H	WT. (LBS.)	PRICE EACH	
				1	3+
H-3945*	Aluminum Frame	3 x 2'	8	\$43	\$41
H-3946		4 x 3'	15	85	80
H-5824		5 x 3'	22	144	136
H-3947		6 x 4'	34	190	180
H-3948		8 x 4'	40	280	265
H-1841*	Oak Frame	3 x 2'	9	51	48
H-1434		4 x 3'	16	96	91
H-5825		5 x 3'	26	175	165
H-1435		6 x 4'	35	230	220
H-3949		8 x 4'	48	315	295
H-3950*	Combination	3 x 2'	10	94	89
H-3951		4 x 3'	15	137	129

**ENCLOSED** – Locking, shatterproof clear acrylic doors.

H-3040*	1 Door, Alum. Frame	2 x 3'	20	\$330	\$310
H-3041	2 Door, Alum. Frame	4 x 3'	33	495	475

\* SHIPS VIA UPS

SHIPS VIA MOTOR FREIGHT

# DRY ERASE BOARDS

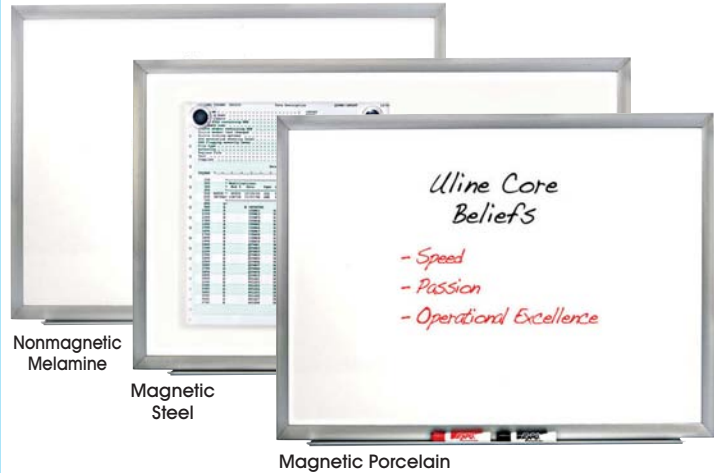

Writing glides on smoothly and wipes off easily.

**Nonmagnetic** – White melamine surface resists scratching. Aluminum frame.

**Magnetic** – Doubles as dry erase and magnetic bulletin board.

- **Steel** – Tough surface, lasts for years. Marker included.
- **Porcelain** – Lasts a lifetime. Won't stain, scratch or ghost.

MODEL NO.	SURFACE	SIZE W x H	WT. (LBS.)	PRICE EACH	
				1	3+
H-616*	Nonmagnetic Melamine	3 x 2'	7	\$50	\$47
H-617		4 x 3'	13	88	83
H-7728		5 x 3'	24	149	142
H-1840		6 x 4'	37	195	185
H-2757		8 x 4'	47	260	245
H-5827*	Magnetic Steel	3 x 2'	9	88	83
H-5828		4 x 3'	22	170	160
H-7729		5 x 3'	28	220	210
H-5829		6 x 4'	47	305	290
H-5830		8 x 4'	61	375	355
H-2566*	Magnetic Porcelain	3 x 2'	14	155	145
H-2567		4 x 3'	25	255	240
H-7730		5 x 3'	33	335	315
H-2568		6 x 4'	55	430	405
H-2758		8 x 4'	71	580	550

\* SHIPS VIA UPS

SHIPS VIA MOTOR FREIGHT

# ULINE DRY ERASE MARKERS

Alcohol-based German ink for long-lasting, bold colors.

- Bullet tip for smooth, even lines.
- Comfort grip barrel.



\* Includes one of each: Black, Blue, Green and Red

MODEL NO.	DESCRIPTION	COLOR	QTY./BOX	PRICE PER BOX	
				1	3+
S-22751	Uline	Black	12	\$19	\$18
S-22752*		Assortment Pack	4	7	6

# CALENDARS

Set important meeting due dates. Wipes off easily.

- Magnetic steel surface.
- Black aluminum frame.



MODEL NO.	DESC.	MODEL NO.	DESC.	SIZE W x H	WT. (LBS.)	PRICE EACH	
						1	3+
H-5919	1 Month	H-5826	12 Month	3 x 2'	16	\$150	\$140
H-5920	4 Month						

## POLY PEGBOARDS

Hot, wet or cold. Stylish and durable in any climate.

- Will not rust, crack or break.
- Recommended for trendy kitchens, cleanrooms and repair areas.
- Commercial-grade 1/4" polypropylene.
- 9/32" diameter holes are 1" apart.
- Use with zinc-plated or black accessories.

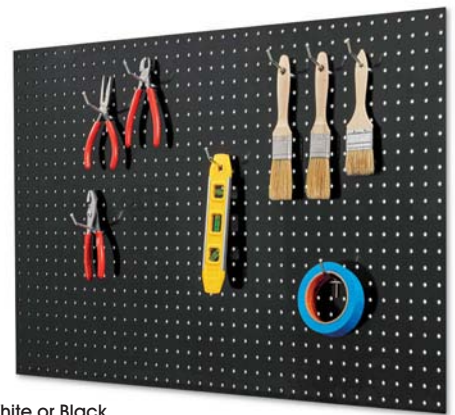

**Starter Kit** – Includes 48 x 24" poly pegboard, mounting hardware and 43-piece assortment of zinc-plated hooks and holders.

SPECIFY COLOR: White or Black

MODEL NO.	DESCRIPTION	SIZE W x H	QTY./PACK	PRICE PER PACK	
				1	3+
H-7791 ■H-8498	Poly Pegboard	48 x 24" 96 x 48"	1	\$63 220	\$60 205
H-7792	Poly Pegboard Starter Kit			\$99 each	
H-2686	Pegboard Mounting Hardware			\$5 each	

■ SHIPS VIA MOTOR FREIGHT

**Mounting Hardware** – Includes 12 each: screws, plastic drywall anchors and 1/2" spacers.

## PEGBOARD CARTS

Organize and move tools anywhere. Easy to maneuver. Handles on both ends.

- Double-sided 20-gauge steel construction. 9/32" diameter pegboard holes are spaced 1" apart.

MODEL NO.	DESC.	DIMENSIONS W x H x D	LOAD CAPACITY	WT. (LBS.)	PRICE EACH	
					1	3+
H-6462	Pegboard Cart	37 x 64 x 24"	1,000 lbs.	124	\$420	\$395
H-6463		49 x 64 x 24"		154	475	450

SHIPS UNASSEMBLED VIA MOTOR FREIGHT

- 5" polyolefin casters: 2 swivel with brake, 2 rigid.
- Cart with Shelves and Floor Racks, see [uline.com](http://uline.com)



## PEGBOARD STORAGE CABINETS

Eliminate security concerns. Recommended for the serious organizer.

- Hang power tools, wrench sets and tape guns on full-length pegboard panels.
- 9/32" diameter pegboard holes are spaced 1" apart.
- All-welded 16-gauge steel construction. 16" shelves adjust in 2" increments.
- 3-point locking system – Keys included.

MODEL NO.	DESCRIPTION	DIMENSIONS W x D x H	WT. (LBS.)	PRICE EACH	
				1	2+
H-9935	3-Shelf Cabinet	48 x 24 x 78"	435	\$1,900	\$1,850
H-9936	5-Shelf Cabinet		485	2,100	2,050

SHIPS ASSEMBLED VIA MOTOR FREIGHT



5-Shelf Cabinet

## PARTITIONS

Two-sided partitions are handy for meetings, brainstorming and dividing open spaces.

- Porcelain whiteboard on one side for writing notes and ideas.
- Fabric bulletin board on the other side for posting important notices.
- Smooth rolling swivel wheels, 2 locking.
- Sturdy metal frame.
- **Dry Erase/Dry Erase Partition** information, see [uline.com](http://uline.com)

MODEL NO.	DESCRIPTION FRONT/BACK	SURFACE	SIZE W x H	TOTAL HEIGHT	WT. (LBS.)	PRICE EACH	
						1	3+
H-5860	Dry Erase/Dry Erase	Magnetic Steel	4 x 6'	74"	58	\$320	\$310
H-5861	Dry Erase/Bulletin Board	Magnetic Porcelain			91	890	875

SHIPS UNASSEMBLED VIA MOTOR FREIGHT

## DRY ERASE/BULLETIN BOARD



Dry Erase/  
Bulletin Board



Dry Erase/  
Dry Erase

# PEGBOARDS AND ACCESSORIES



WOOD

Organize tools and accessories. Excellent for shops and garages.

**Wood** – Sturdy 1/4" thick tempered hardboard. Smooth finished surface on both sides.

**Steel** – Never cracks. Never breaks. Heavy duty 20-gauge steel.

- 9/32" diameter holes are 1" apart.



STEEL

**Starter Kits** – Include 48 x 24" pegboard pack, mounting hardware and 43-piece assortment of zinc-plated hooks and holders.

## WOOD

MODEL NO.	DESCRIPTION	SIZE W x H	QTY./PACK	PRICE/PACK	
				1	3+
H-2683	Wood Pegboard	48 x 24"	2	\$49	\$47
■H-5796		96 x 48"		170	165
H-2684	Wood Pegboard Starter Kit			\$85 each	
H-2686	Wood Pegboard Mounting Hardware			\$5 each	

■ SHIPS VIA MOTOR FREIGHT

## STEEL

\* SPECIFY COLOR: Black or Gray

MODEL NO.	DESCRIPTION	SIZE W x H	QTY./PACK	PRICE/PACK	
				1	3+
H-4293*	Steel Pegboard	48 x 24"	1	\$58	\$55
■H-6450*		96 x 48"		195	185
H-4292*	Steel Pegboard Starter Kit			\$95 each	
H-4294	Steel Pegboard Mounting Hardware			\$5 each	

■ SHIPS VIA MOTOR FREIGHT

## PEGBOARD ACCESSORIES



Add versatility to existing pegboards.

- Available in zinc-plated or black epoxy finish. Provides long-lasting durability.
- Use with Pegboards up to 1/4" thick.

**43-Piece Assortment Kits** – Include 10 each: 3" and 5" straight hooks, 5" double straight hooks, 7/8" double-ring holders and 3 multi-prong holders.

### BLACK EPOXY

MODEL NO.	DESCRIPTION	ROD THICKNESS	QTY./PACK	PRICE/PACK			
				1	3+		
H-7136	43-Piece Assortment Kit	N/A	N/A	\$52	\$47		
H-7137	3" Straight Hook	1/4"	10	9	8		
H-10368	4" Straight Hook			10	9		
H-7138	5" Straight Hook			11	10		
H-10015	6" Straight Hook			12	11		
H-7139	8" Straight Hook			13	12		
H-10016	11" Straight Hook			14	13		
H-7140	3" Double Straight Hook			1/4"	10	16	15
H-7141	5" Double Straight Hook					19	18
H-10369	8" Double Straight Hook					24	22
H-10017*	8" Scanner Hook			1/4"	10	22	21
H-10018*	10" Scanner Hook	23	22				
H-7560	8 3/8" Wire Basket	3/16"	1	13	12		
H-7561	14" Wire Basket			21	20		

\* Insert cards, see uline.com

### ZINC-PLATED

MODEL NO.	DESCRIPTION	ROD THICKNESS	QTY./PACK	PRICE/PACK			
				1	3+		
H-2685	43-Piece Assortment Kit	N/A	N/A	\$37	\$33		
H-6447	2" Straight Hook	1/4"	10	6	5		
H-2687	3" Straight Hook			7	6		
H-6448	4" Straight Hook			8	7		
H-2688	5" Straight Hook			9	8		
H-6449	6" Straight Hook			10	9		
H-2689	8" Straight Hook			11	10		
H-3883	11" Straight Hook			12	11		
H-10370	12" Straight Hook			14	13		
H-2690	3" Double Straight Hook			1/4"	10	14	13
H-2691	5" Double Straight Hook					17	16
H-2692	8" Double Straight Hook	21	19				
H-4451*	8" Scanner Hook	1/4"	10	19	18		
H-5797*	10" Scanner Hook			20	19		
H-2693	1 1/2" Angled L-Hook	1/4"	50	14	13		
H-2694	5/8" Curved J-Hook			13	12		
H-2695	1 1/2" Curved J-Hook			16	15		
H-2696	7/16" Double-Ring Tool Holder	3/16"	10	6	5		
H-2697	7/8" Double-Ring Tool Holder			7	6		
H-2698	9/16" Multi-Prong Tool Holder	3/16"	3	7	6		
H-5798	3 5/8" Plastic Bin	N/A	12	30	28		
H-6451	8 3/8" Wire Basket	3/16"	1	11	10		
H-6452	14" Wire Basket			18	17		

\* Insert cards, see uline.com





## EASELS

Use in all your conference rooms.

- Adjustable: 34" table height. 64 $\frac{1}{4}$ " stand alone height.
- Center locking brace. Folds for storage.



H-7793 – Holds twice the capacity for artwork.

SPECIFY COLOR: Silver or Black

MODEL NO.	DESCRIPTION	CAP. (LBS.)	PRICE EACH	
			1	3+
H-1450	Standard	25	\$87	\$83
H-7793*	Heavy Duty	45	185	175

\*Includes Flip Chart Bar

## EASEL PADS

**Paper Pads** – 3-hole punched; hangs on holder pegs.

**3M Post-It® Pads** – Removable adhesive sticks to walls.

**Flip Chart Bar** – Attach to H-1450 Easel to hold pads.



\*SPECIFY COLOR: Silver or Black

MODEL NO.	DESCRIPTION	SIZE W x H	SHEETS/PAD	PADS/CTN.	PRICE/CTN.	
					1	3+
S-12209	Paper Pads	27 x 34"	50	2	\$52	\$49
S-19661	3M Post-It® Pads	25 x 30"	30		70	66
H-1451*	Flip Chart Bar for H-1450				55	53



IN STOCK – SHIPS TODAY

## MOBILE GLASS DRY ERASE BOARDS

A touch of New York style for modern offices and shared workspaces.

- Double-sided tempered glass is easy to clean and lasts forever.
- Magnetic surface. Includes 4 extra strength magnets and marker tray.
- Durable, powder-coated 16-gauge steel frame. Extra wide for stability.
- 3" polyurethane swivel casters, 2 locking.

Glass Dry Erase Partitions, see [uline.com](http://uline.com)

MODEL NO.	DESCRIPTION	SIZE W x H	TOTAL HEIGHT	WT. (LBS.)	PRICE EACH	
					1	3+
H-8533	Magnetic White	3 x 4'	75"	156	\$995	\$950
H-8534		6 x 4'		360	1,550	1,450

SHIPS UNASSEMBLED VIA MOTOR FREIGHT

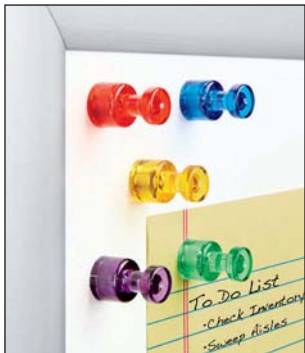

PUSH PINS

## DRY ERASE BOARD MAGNETS

Turn magnetic whiteboards into bulletin boards.

**Push Pin Magnets** – Hang documents and signs on steel or porcelain dry erase boards.

**Magnetic Discs** – Keep track of employees on in/out staff boards.

**Extra Strength** – Neodymium rare earth magnets. Used on glass dry erase boards.

\* Minimum 6



DISCS

EXTRA STRENGTH

MODEL NO.	DESCRIPTION	COLOR	QTY./PACK	PRICE PER PACK	
				1	3-6+
S-23218	1/2" Push Pin Magnets	Assortment	20	\$22	\$21
S-23219*	1" Magnetic Discs	Pack	16	N/A	6
S-24334	1" Extra Strength	Clear	10	20	19

## 3-RING BINDERS

Organize and store operating procedures, manuals and reports.

**Binders** – Reinforced polypropylene resists cracking and splitting.

**Multi-Color Tab Dividers** – Sturdy manila sheets with colored tabs.

**Sheet Protectors** – Acid free. Nonstick interior.



BINDERS



8-TAB DIVIDERS



SHEET PROTECTORS

SOLD IN CARTON QUANTITIES

SPECIFY COLOR: White, Black or Red

MODEL NO.	DESCRIPTION	RING SIZE	SHEET CAPACITY	QTY./CTN.	PRICE PER BINDER		
					2	4	8+
S-21760	Heavy Duty View Binder	1"	275	4	N/A	\$10	\$9
S-21761		2"	540	4	N/A	12	11
S-21762		3"	670	2	\$16	15	14
S-21763	8-Tab Dividers; 12 Sets/Pack				\$24/pack		
S-21764	Sheet Protectors; 100/Box				\$18/box		

## BALLPOINT PENS



**Uline** – High-quality ink delivers crisp, clean lines.

**BIC** – Smooth writing with a rubber grip.

**Paper Mate** – Thick, soft, comfortable grip. #1 seller.

SOLD IN MULT. OF 12

SPECIFY COLOR: Black or Blue

MODEL NO.	DESCRIPTION	TIP SIZE	PRICE PER PEN		
			12	48	144+
S-20663*	Uline Retractable	Medium	\$.78	\$.75	\$.72
S-21757	BIC® Velocity™	Medium	1.00	.95	.90
S-20664	Paper Mate® Profile®	Bold	1.25	1.20	1.15

\*Available in Black only

## GEL PENS



**BIC** – Smooth writing with extra wide, nonslip comfort grip.

**Uni-Ball** – Intense color. Cannot be washed from checks.

**Pilot** – Smooth gel ink glides on paper. Best seller.

SOLD IN MULT. OF 12

SPECIFY COLOR: Black or Blue

MODEL NO.	DESCRIPTION	TIP SIZE	PRICE PER PEN		
			12	48	144+
S-21758	BIC® Gel-ocity™	Fine	\$1.40	\$1.30	\$1.20
S-21759	Uni-Ball® 207™		1.90	1.80	1.70
S-20665	Pilot® G-2®		2.15	2.05	1.95

## BINDER CLIPS



Securely bind thick reports, manuals and files.

- Durable metal clip provides a firm grip.
- Handles fold down for file storage.

MODEL NO.	DESC.	WIDTH	SHEET CAPACITY	CLIPS/ BOX	CLIPS/ PACK	PRICE PER PACK		
						1	2	3+
S-24648	Small	3/4"	50	12	144	\$13	\$12	\$11
S-24649	Medium	1 1/4"	100			19	18	17
S-24650	Large	2"	150			50	48	46

## SCISSORS



**Comfort Grip** – Soft rubber handle for extended use.

**Office** – Ergonomic plastic handle for general use.

**Industrial** – Extra-large shears glide through thick paper and corrugated.

\*For left or right hand

MODEL NO.	DESCRIPTION	OVERALL LENGTH	CUT LENGTH	PRICE EACH		
				1	3	6+
H-6415*	Comfort Grip	8"	4"	\$11	\$10	\$9
H-1000	Office	8"	4"	16	15	14
H-1794	Industrial	10"	5"	45	43	41

## INDUSTRIAL MAGNETIC CLIPS New



Hang documents on steel filing cabinets or warehouse racking.

- Strong square magnet. Chrome finish.
- Heavy-duty spring clip.

MODEL NO.	WIDTH	OPENING CAPACITY	SHEET CAPACITY	CLIPS/ BOX	PRICE PER BOX		
					1	2	3+
S-25010	1 1/2"	3/4"	75	10	\$26	\$25	\$24
S-25011	1 3/4"	7/8"	100		28	27	26

## DESK CALENDARS

Keep track of appointments, meetings and daily to-dos.

- One page per month. January through December.



AT-A-GLANCE®

SOLD IN CARTON QUANTITIES

MODEL NO.	DESCRIPTION	YEAR	SIZE W x H	QTY./ CTN.	PRICE PER CALENDAR	
					1 CTN.	2+ CTNS.
S-25479	Lined	2024	22 x 17"	24	\$10	\$9
S-25480	Unlined				12	20

Made in the USA



## NOTEPADS

Take notes in meetings or on warehouse walks.

- Perforated for clean, easy sheet removal.

SPECIFY COLOR: White or Canary

MODEL NO.	DESCRIPTION	SIZE	SHEETS/ PAD	PADS/ PACK	PRICE PER PACK	
					1	3+
S-21131	Memo	5 x 8"	50	12	\$19	\$18
S-21132	Letter	8 1/2 x 11 1/4"			23	22

## CALCULATOR

Solutions at your fingertips.

- Large, easy-to-read, 12-digit angled LCD display.
- Includes cost, sell and margin keys.



MODEL NO.	DESCRIPTION	SIZE W x L	PRICE EACH	
			1	3+
H-5641	Desktop Calculator	4 x 6"	\$21	\$20

# BATTERIES

## RAYOVAC®

MODEL NO.	DESCRIPTION	QTY./PACK	PRICE PER PACK		
			1	3	6+
S-11842	Alkaline AAA	18	\$14	\$13	\$12
S-11843	Alkaline AA	24	\$13 per pack any quantity		
S-11844	Alkaline C	12	16	15	14
S-11845	Alkaline D	12	21	20	19
S-22092	Alkaline 9V	12	27	26	25

## DURACELL®

MODEL NO.	DESCRIPTION	QTY./PACK	PRICE PER PACK		
			1	3	6+
S-15604	Alkaline AAA	24	\$18	\$17	\$16
S-15605	Alkaline AA	24	\$15 per pack any quantity		
S-15606	Alkaline C	12	19	18	17
S-15607	Alkaline D	12	23	22	21
S-17590	Alkaline 6V Lantern	1	16	15	14
S-15608	Alkaline 9V	12	32	31	30

## ENERGIZER® LITHIUM

MODEL NO.	DESCRIPTION	QTY./PACK	PRICE PER PACK		
			1	3	6+
S-23984	Lithium AAA	24	\$83	\$81	\$79
S-23985	Lithium AA				

## RAYOVAC®

Industrial-duty alkaline batteries.

- Performs well in extreme temperatures -20° to 130°F.
- 5-year shelf life. Date coded.



## DURACELL®

Long-lasting alkaline power.

- Performs well in extreme temperatures -4° to 130°F.
- Up to 7-year shelf life. Date coded.



## ENERGIZER® LITHIUM

9 times the power of standard batteries. Use in digital cameras.

- Performs well in extreme temperatures -40° to 140°F.
- 20-year shelf life. Date coded.



Recycling Pail, see [uline.com](http://uline.com)

## ULINE TOOL BAG



Outfit your entire crew.

- Heavyweight polyester with rigid plastic bottom.
- Super wide opening. Shoulder strap included.
- 16 pockets – 6 inside, 10 outside.

MODEL NO.	DESCRIPTION	DIMENSIONS L x W x H	WT. (LBS.)	PRICE EACH	Free with a Uline order of
					\$500+
S-23388	Tool Bag	16 x 9 x 10"	3	\$40	

## ULINE ULTRA BATTERIES

Rely on the power of Uline.

- Dependable alkaline batteries.
- Performs in temperatures 0° to 122°F.
- 5-year shelf life. Date coded.



MODEL NO.	DESCRIPTION	QTY./PACK	PRICE PER PACK		
			1	3	6+
S-22762	Alkaline AAA	24	\$10	\$9	\$8
S-22763	Alkaline AA				

## TAPE MEASURES



ULINE

H-1766

Accu-Lock – Long-lasting nylon coated. Comfortable rubber grip.



ULINE

H-2494

Metric – Includes cm, mm and inch markings.



ULINE

H-3749

Super Max – Dual end hook. Double-sided numbering.



Figure UPS and freight cubes.



H-3999

EZ-Read – Easy-to-read fractions and decimals.

MODEL NO.	DESCRIPTION	SIZE	PRICE EACH	
			1	4+
H-2064	Uline Accu-Lock	5/8" x 12'	\$7	\$6
H-1766	Uline Accu-Lock	1" x 25'	10	9
H-2494	Uline Metric	1" x 25/7.5M	11	10
H-3749	Uline Super Max	1 1/4" x 30'	20	19
H-3999	Uline EZ-Read	1" x 25'	13	12
H-513	Stanley® Leverlock®	1/2" x 12'	8	7
H-1842	Stanley® FatMax®	1 1/4" x 25'	29	28



STANLEY®

H-513

Leverlock® – Automatic bottom lock.



H-1842

FatMax® – 1 1/4" wide blade. Large, easy-to-read numbers.



# CLIPBOARDS



Every warehouse has these.

**Plastic** – Unbreakable. Clip holds 1" stack of paper securely.

**Pressboard** – Sturdy, easy-to-write-on hardboard.

**Aluminum** – Smooth writing surface. Strong and durable.

**Aluminum Top Opening** – With license/credit card holder or large-face calculator. Latching case keeps 30+ forms safe and dry. Pen tray.

**Aluminum Side Opening** – Swivel bar clip. Stores up to 30 forms.

\* Min. Order 12    ▲ SPECIFY COLOR: ■ Red ■ Black ■ Blue  Clear

MODEL NO.	DESCRIPTION	TYPE	SIZE	PRICE EACH	
				1	12+
S-15545▲	Standard	Plastic	Letter	\$7	\$6
S-6615*	Standard	Pressboard	Letter	N/A	2
S-6616*	Standard		Legal		
S-19422	Standard	Aluminum	Letter	12	11
S-20173	Top Opening			31	30
S-6617	Side Opening			32	31
S-20174	Top Opening w/ Calculator			46	44

## STORAGE CLIPBOARDS



Use during warehouse audits or site visits.

S-20583

- Interior storage for pens and clips.
- Convenient carrying handle.
- Holds letter-size paper.
- Lightweight polypropylene.

SPECIFY COLOR: Black, Blue or Orange

MODEL NO.	DESCRIPTION	PRICE EACH	
		1	12+
S-20582	Bottom Opening	\$16	\$15
S-20583	Bottom Opening w/ Calculator	22	21

## WALL CLOCKS



Hang these large, easy-to-read clocks around your office or warehouse.

**Colored** – Decorative and stylish.

**Traditional** – Accurate, reliable quartz movement.

**Radio Controlled** – Synchronized via radio signal with U.S. Atomic Clock. Adjusts automatically. Easy to set time.

\* Min. 2. SPECIFY COLOR: Black, Lime Green or Red.

MODEL NO.	DESCRIPTION	SIZE	WT. (LBS.)	PRICE EACH	
				1	5+
H-3085*	Colored	9"	1	\$11	\$10
H-1436	Traditional	12"	2	22	21
H-4570		19"	4	70	67
H-2811	Radio Controlled – Plastic	14"	2	57	55

19" recommended for warehouses.

AA batteries not included, see page 636

## DRAWER ORGANIZER



**RUBBERMAID®**

Organize supplies.

- 7 compartments.
- Lightweight polypropylene.

SOLD IN CARTON QUANTITIES

MODEL NO.	SIZE W x D x H	QTY./ CTN.	PRICE EACH	
			6	12+
H-10448	12 x 15 x 2 1/2"	6	\$12	\$11

## DIGITAL WALL CLOCK



Bright LED display is easy to read from up to 250 feet away.

- Hang in warehouses, factories and large indoor spaces.
- 4-digit format. 12 or 24 hour time.
- Internal battery backup.
- 6' power cord plugs into standard 110 volt outlet.

MODEL NO.	DESCRIPTION	NUMBER HEIGHT	SIZE W x H	PRICE EACH	
				1	3+
H-5672	Digital Wall Clock	4"	12 x 6"	\$275	\$265



# INDUSTRIAL PVC SLATWALL

Organize your company tool rooms or maintenance areas.

- Stronger than traditional slatwall, yet light and easy to clean.
- Heavy-duty accessories lock in place. Holds up to 100 lbs.
- Easily add sections. Kit includes panels, miter-cut trim, mounting hardware and channel strips.

\* SPECIFY SLATWALL COLOR: Gray or Black

MODEL NO.	DESCRIPTION	SIZE	WT. (LBS.)	PRICE EACH	
				1	3+
H-8743*	PVC Slatwall Kit	4 x 4'	23	\$165	\$155
■H-9138*		4 x 8'	44	295	275
H-8746	Wire Basket	18 x 13 x 8"	4	32	30
H-8744	6" J-Hook	H-8745	8" Double Hook	15	14

EASY ASSEMBLY

■ SHIPS VIA MOTOR FREIGHT



J-Hook

Double Hook

## ULINE FLASHLIGHTS

Intense LED beam for the job site, road or evening patrol.

Slim – Fits in your pocket. For repairmen and inspectors.

Full Size – Tactical grade for law enforcement and security. High/low settings.

Rechargeable – Includes USB charging cable. 4 settings – high, low, strobe and SOS.



Slim

Rechargeable

SPECIFY COLOR: Black or Red

MODEL NO.	DESCRIPTION	SIZE	LUMENS	PRICE EACH	
				1	6+
H-7731*	Slim	6"	250	\$24	\$23
H-7732*	Full Size	12"	900	35	33
H-7733	Rechargeable	6"	850	70	66

\* Batteries sold separately, see page 636



Full Size

## INDUSTRIAL AIR HOSE REELS

Lasts a lifetime. Use in warehouses, auto shops and fleet maintenance facilities.

- Keeps hose neatly out of sight. Self-retracting.
- 1/2" Diameter – Larger air volume for foam packing pumps.
- 100' Length – Extended reach for large shipping departments.
- For use with Air Compressors, see uline.com

Max. Temp.: 150°F

MODEL NO.	HOSE DESCRIPTION	REEL DIM. W x D x H	HOSE		MAX. PSI	WT. (LBS.)	PRICE EACH
			DIAM.	LENGTH			
H-1402	PVC	13 x 6 x 13"	1/4"	35'	300	17	\$295
H-1403		18 x 6 x 17"	3/8"	50'		31	405
H-7158		21 x 7 x 20"	1/2"	50'		44	570
■H-7159		21 x 9 x 20"	3/8"	100'		62	785

SHIPS ASSEMBLED

■ SHIPS VIA MOTOR FREIGHT



REELCRAFT®

## PAINT BRUSHES AND ACCESSORIES

WOOSTER®



Cheesecloth Wipers available, see uline.com



Angled

Flat

Paint Brushes – Firm nylon/polyester bristles. Sealed wood handle.



Roller Frame – Smooth rolling cage. Retaining ring locks covers in place.



Roller Covers – Shed-free, woven fibers with 3/8" nap for a smooth finish.



Metal Tray – Rust-resistant steel. Durable, welded legs keep tray level.

The brand professionals trust. Used for any size facility or maintenance project.

### ULTRA/PRO® BRUSHES

MODEL NO.	DESC.	MODEL NO.	DESC.	WIDTH	PAINT TYPE	PRICE EACH (MIN. 2)	
						2	6+
H-8628	Angled Sash	H-8631	Flat Sash	2"	All Paints and Stains	\$13	\$12
H-8629		H-8632	2 1/2"	16		15	
H-8630		H-8633	3"	19		18	

### ROLLERS AND ACCESSORIES

\* Price per pack

MODEL NO.	DESCRIPTION	WIDTH	PRICE EACH	
			3	6+
H-8634	Roller Frame	9"	\$12	\$11
S-23509*	Roller Covers – 3 pk.		16	15
H-8635	Metal Tray	11"	6	5

# TOOL SETS



## HOME

Handy 121-piece tool set for everyday use.

- Drop forged steel.

Includes: (1) ratchet handle, (26) sockets, (10) combination wrenches, (19) drive bits, (2) screwdrivers and more.

1 Year Warranty

MODEL NO.	DESCRIPTION	CASE SIZE W x H x D	WT. (LBS.)	PRICE EACH	
				1	3+
H-706	121-Piece Set	14 x 18 x 3"	12	\$68	\$64

## SHOP

180 precision tools handle most repairs.

- Chrome-vanadium steel.

Includes: (2) ratchet handles, (79) sockets, (12) combination wrenches, (48) drive bits, (4) screwdrivers and more.

Meets ANSI and ASME specifications

Lifetime Warranty

MODEL NO.	DESCRIPTION	CASE SIZE W x H x D	WT. (LBS.)	PRICE EACH	
				1	3+
H-9289	180-Piece Set	16 x 19 x 4"	18	\$185	\$175



CRESCENT®

# 5S TOOLBOX FOAM

For the neat freaks. Keep your toolboxes and drawers pristine and organized.

- Durable kaizen polyethylene foam is made up of multiple 1/8" layers.
- Cut your tool outlines with a utility knife and peel layers to desired depth.

SPECIFY COLOR:  Black  Black/Red

MODEL NO.	DESCRIPTION	SHEET SIZE L x W	THICKNESS	PRICE PER SHEET		
				3	9	18+
S-24995	5S Toolbox Foam	24 x 48"	7/8"	\$18	\$17	\$16
S-24285			1 1/8"	23	22	21
S-24286			2 1/4"	40	38	36

Sold in multiples of 3

**Black/Red** – Gives every tool an easy-to-see home.

**Black** – Clean uniform look.



# ULINE TOOL CART

Move your tools where you need them.

- Full-extension steel drawers with nonslip vinyl liners.
- PVC work surface flips open for extra storage. Lockable.

4 Drawer Cabinet – (2) 12 x 17 x 3", (1) 25 x 17 x 3" and (1) 25 x 17 x 6"

SPECIFY COLOR: Black or Red

MODEL NO.	DESCRIPTION	DIMENSIONS L x W x H	LOAD CAPACITY	WT. (LBS.)	PRICE EACH	
					1	3+
H-8520	4 Drawer	31 x 20 x 42"	1,250 lbs.	134	\$605	\$585

EASY ASSEMBLY. SHIPS VIA MOTOR FREIGHT.

- 5" polypropylene casters: 2 swivel with brake, 2 rigid.



# ULINE TOOL CABINETS

Lifetime investment – Heavy duty. Built to last.

- Steel drawers for hand and power tools. Lockable.
- Nonslip vinyl drawer liners keep tools in place.
- 5" polypropylene casters: 2 swivel with brake, 2 rigid.

4 Drawer – Fits under workbenches. 34" high.



11 Drawer Cabinet – (1) 37 x 16 x 4", (5) 22 x 16 x 3", (1) 22 x 16 x 6", (3) 12 x 16 x 3", (1) 12 x 16 x 12"

SPECIFY COLOR: Black or Red

MODEL NO.	DESCRIPTION	DIMENSIONS L x W x H	LOAD CAPACITY	WT. (LBS.)	PRICE EACH	
					1	3+
H-8945*	4 Drawer	27 x 18 x 34"		103	\$525	\$505
H-8946	6 Drawer	27 x 18 x 40"	2,100 lbs.	128	635	610
H-8947	11 Drawer	42 x 19 x 40"		242	1,060	1,030

\* Pictured on uline.com

SHIPS VIA MOTOR FREIGHT



6 Drawer Cabinet – (3) 22 x 16 x 3", (3) 22 x 16 x 6"



# INDUSTRIAL MARKERS

## SHARPIE®



Durable fine tip perfect for marking on shipping labels, plastic or corrugated.

- Heat and water resistant, smear-proof permanent ink.
- S-13628 Sharpie® Metallic – Vividly marks dark surfaces.
- S-19421 Sharpie® Ultra Fine – For precise marking.

## SUPER SHARPIE®



Super large ink supply. Holds twice as much ink.

- Heavy duty bold point permanently marks signs and labels.

SPECIFY COLOR: ■ Black ■ Red ■ Blue

MODEL NO.	DESCRIPTION	PRICE EACH (MULTIPLES OF 12)			
		12	36	72	144+
H-286	Sharpie®	\$1.25	\$1.15 each		
S-13628▲	Sharpie® Metallic	2.05	\$1.95	\$1.90	\$1.85
S-19421	Sharpie® Ultra Fine	1.35	1.30	1.25	1.20
H-734*	Super Sharpie®	2.15	2.05	2.00	1.95
H-1241	Sharpie® Retractable	2.75	2.65	2.60	2.55

\*Black only

▲Specify Silver or Gold

## ULINE COMFORT-GRIP



Soft rubber handle – For excellent grip and control.

- Fine tip permanent marker.
- Low odor. Nontoxic. • Instant drying.

SPECIFY COLOR: ■ Black ■ Silver ■ Red ■ Blue

MODEL NO.	DESCRIPTION	PRICE EACH (MULTIPLES OF 12)			
		12	36	72	144+
S-12699	Uline Fine Tip	\$.70	\$.55 each		

# UNI® PAINT MARKERS



Fast drying, vivid marks without streaking for indoor use.

- Oil-based paint with xylene resists water and abrasions.

SPECIFY COLOR: ■ White ■ Yellow ■ Black ■ Blue ■ Green

MODEL NO.	DESCRIPTION	PRICE EACH (MULTIPLES OF 12)			
		12	36	72	144+
S-19423	Uni® Paint Medium Tip	\$3.95	\$3.75	\$3.60	\$3.45

# PAINT MARKERS

## ULINE



Uline quality and value. Indoor/outdoor use.

- Oil-based paint leaves permanent marks.

SPECIFY COLOR: ■ White ■ Yellow ■ Black

MODEL NO.	DESCRIPTION	PRICE EACH (MULTIPLES OF 12)			
		12	36	72	144+
S-20622	Uline Medium Tip	\$2.85	\$2.70	\$2.55	\$2.45

## MARSH®



General purpose alcohol-based paint resists UV rays.

- Permanently marks metal, wood, cardboard and plastic.

## MARSH® 88fx



SPECIFY COLOR: ■ White ■ Yellow ■ Black ■ Blue

MODEL NO.	DESCRIPTION	PRICE EACH (MULTIPLES OF 12)			
		12	36	72	144+
H-257	Marsh® Medium Tip	\$3.10	\$2.95	\$2.80	\$2.70

## MARKAL®



The industry leader. Writes on any surface.

- Designed for the toughest jobs – indoors and out.
- Industrial oil-based paint leaves permanent marks.

SPECIFY COLOR: ■ White ■ Yellow ■ Black

MODEL NO.	DESCRIPTION	PRICE EACH (MULTIPLES OF 12)			
		12	36	72	144+
S-20621	Markal® Medium Tip	\$3.95	\$3.75	\$3.60	\$3.45

# BRITE-MARK® PAINT MARKERS



## DYKEM®

Bright permanent marks for harsh outdoor environments.

- Durable oil-based paint stands up to UV rays.

SPECIFY COLOR: ■ White ■ Yellow ■ Black ■ Blue

MODEL NO.	DESCRIPTION	PRICE EACH (MULTIPLES OF 12)			
		12	36	72	144+
S-21125	Brite-Mark® Medium Tip	\$4.90	\$4.65	\$4.40	\$4.15

# SHARPIE® PALLET MARKERS

## KING SIZE



1/4" wide chisel-tip stands up to abuse.



- Quick drying permanent ink.
- Marks on any surface – Even damp or oily.

## MAGNUM



Extra-large 5/8" wide tip; excellent for boxes, posters, pallets and signs.

- Water-resistant, quick drying, permanent ink.

## PROFESSIONAL



Long-lasting 1/4" wide chisel-tip marker stands up to hard use.

- Permanently marks wet, oily, smooth or abrasive surfaces.
- Ergonomic handle. Stronger, improved formula.

\*Black only SPECIFY COLOR: ■ Black ■ Red ■ Blue

MODEL NO.	DESCRIPTION	PRICE EACH (MULTIPLES OF 12)			
		12	36	72	144+
H-255	Sharpie® King Size	\$2.40	\$2.25	\$2.15	\$2.05
H-384	Sharpie® Magnum	4.95	4.70	4.45	4.20
H-8550*	Sharpie® Professional	4.35	4.10	3.85	3.60

# MEAN STREAK® PAINT MARKERS



"Paint in a tube" recommended for use on glass, rubber, metal and plastic.



- 1/2" wide tip creates bright marks on wet or dry surfaces.
- Resists water, fading and UV rays. • Dries in minutes.

SPECIFY COLOR: □ White ■ Yellow

MODEL NO.	DESCRIPTION	PRICE EACH (MULTIPLES OF 12)			
		12	36	72	144+
H-763	Mean Streak®	\$6.25	\$6.00	\$5.75	\$5.50

# ULINE PALLET MARKERS

## CHISEL-TIP



Large 1/2" wide tip; excellent for cardboard, wood and cloth.

- Waterproof, fadeproof ink. • Instant drying.

## JUMBO CHISEL-TIP



Large 1/2" wide chisel-tip; holds 3 times more ink. Lasts and lasts.

- Instant drying, waterproof, fadeproof. Black ink only.

## COMFORT-GRIP



Easy to pick up and write while wearing gloves.

- Soft rubber grip. • 1/4" wide chisel-tip. Black ink only.
- Waterproof, fadeproof ink. • Instant drying.

\* SPECIFY COLOR: ■ Black ■ Red ■ Blue

MODEL NO.	DESCRIPTION	PRICE EACH (MULTIPLES OF 12)			
		12	36	72	144+
S-12700*	Chisel-Tip	\$1.10		\$ .90 each	
S-14356	Jumbo Chisel-Tip	2.80		\$2.05 each	
S-15516	Comfort-Grip	1.10		\$ .90 each	

# VALVE MARKERS



No dryouts. Ink valve guarantees perfect flow.

- Use on corrugated, wood or porous surfaces.
- Waterproof – Fast drying dye ink.
- Permanent opaque ink resists UV rays.

\* SPECIFY COLOR: ■ Black ■ Red ■ Blue

MODEL NO.	DESCRIPTION	PRICE EACH (MULTIPLES OF 12)			
		12	36	72	144+
H-873	Uline Industrial	\$2.40	\$2.30	\$2.20	\$2.10
H-256*	Marsh® 88 Industrial	2.50	2.40	2.30	2.20

# OLFA® SNAP-BLADE KNIVES

## RATCHET LOCK KNIFE

H-711



- Ratchet quickly locks blade at any length for maximum flexibility. Includes 8 snap-off blades – 1 sheet of 8.

## SLIM JIM KNIFE

H-710



- Quality pocket clip.
- Includes 13 snap-off blades – 1 sheet of 13.

## HEAVY-DUTY UTILITY KNIFE

H-2677



- Automatic blade lock and anti-slip handle for the toughest cutting jobs.
- Includes 8 heavy-duty snap-off blades – 1 sheet of 8.
- Uline blades are interchangeable with Olfa® blades.

MODEL NO.	DESCRIPTION	PRICE EACH (MIN. 6)			EXTRA OLFA® BLADES	
		6	12	24+	MODEL	PRICE/10 SHTS.
H-711	Ratchet Lock	\$9.50	\$9.25	\$9.00	H-996B	\$8.60
H-710	Slim Jim	4.40	4.15	3.90	H-710B	5.40
H-2677	Heavy-Duty	11.05	10.80	10.30	H-2677B	9.60

# OLFA® DELUXE CUTTERS



**Concealed Blade** – Cuts stretch wrap, foam and corrugated. Includes 1 blade.

**Scissors** – 7" serrated shears cut thin metal, wire and rope.



MODEL NO.	DESCRIPTION	PRICE EACH		H-9139B EXTRA BLADES
		1	6+	
H-9139	Concealed Blade	\$15	\$14	\$7 10/pk.
H-5542	Scissors	29	28	N/A

# ULINE SNAP-BLADE KNIVES

## SNAP-BLADE KNIFE

H-273



- Automatic locking; retractable safety blade.
- Includes 24 snap-off blades – 3 sheets of 8.

SPECIFY COLOR FOR H-273: ■ Black ■ Red ■ Blue ■ Yellow

## MINI SNAP-BLADE KNIFE

H-1371



- Compact, economical knife clips to pocket.
- Includes 13 snap-off blades – 1 sheet of 13.

SPECIFY COLOR FOR H-1371: ■ Red ■ Blue

## HEAVY-DUTY SNAP-BLADE KNIFE

H-1551



- **Auto-loading** – Eject and reload without touching blades.
- Large, comfortable rubberized grip.
- Includes 48 snap-off blades – 6 sheets of 8.

SPECIFY COLOR FOR H-1551: ■ Black ■ Red ■ Blue ■ Yellow

MODEL NO.	PRICE EACH (MIN. 6)				EXTRA BLADES	
	6	12	24	48+	MODEL	PRICE/10 SHTS.
H-273	\$6.75	\$6.50	\$6.25	\$6.00	H-273B	\$5.00
H-1371	2.60	2.40	2.20	2.00	H-1371B	2.50
H-1551	6.00	5.75	5.50	5.25	H-273B	5.00

# DELUXE KLEVER SAFETY CUTTERS



Soft rubber ergonomic grip. Disposable blade head.

**Dual Sided** – Blade lasts twice as long.

**Single Sided** – Blade cuts thicker materials.



SPECIFY COLOR: Red, Blue, Yellow or Orange

MODEL NO.	DESC.	PRICE EACH (MULTIPLES OF 6)			EXTRA BLADES	
		6	12	24+	MODEL	PRICE/25 PACK
H-3548	Dual	\$9.75	\$9.25	\$8.75	H-3548B	\$22
H-4412	Single				H-4412B	





## ULINE QUICK CHANGE KNIFE

**COMFORT-GRIP**

Lightning-fast blade changes with a comfy, cushioned grip.

- Removable rear compartment holds 5 blades.
- Includes 1 blade. • String cutter.



MODEL NO.	PRICE EACH (MIN. 6)				H-64B EXTRA BLADES
	6	12	24	48+	
H-1469	\$4.95 each any quantity				\$18 100/pk.

## ULINE QUICK CHANGE FOLDING KNIFE

**FITS IN YOUR POCKET**

Easily folds to a safe, compact size.

- Metal body with rubber grip. Convenient belt clip.
- Super fast blade changes.
- Includes 1 blade.

MODEL NO.	PRICE EACH (MIN. 6)				H-64B EXTRA BLADES
	6	12	24	48+	
H-4288	\$8.00	\$7.75	\$7.50	\$7.25	\$18 100/pk.



H-1470



H-838

## QUICKBLADE KNIVES

Automatically loads next blade from storage compartment. Ergonomic handle.

**H-838** – One quick turn of the knob to change blades. Includes 1 blunt-nose blade.

MODEL NO.	PRICE EACH (MIN. 6)				H-64B EXTRA BLADES
	6	12	24	48+	
H-838	\$8.50	\$8.25	\$8.00	\$7.75	\$18 100/pk.
H-1470*	10.75	10.25	9.75	9.50	

\*Includes 5 blades



## STANLEY QUICK CHANGE KNIFE

Change blades in seconds without opening the knife.

- Spare blades available at the push of a button.
- Retractable – 4 blade positions. Includes 3 heavy-duty blades. String cutting feature.

MODEL NO.	PRICE EACH (MIN. 6)				H-64B EXTRA BLADES
	6	12	24	48+	
H-43	\$8.75	\$8.50	\$8.25	\$8.00	\$18 100/pk.

## SCRAPER KNIFE



Every warehouse needs one.

- Scrape paint off, clean glass.
- Retractable locking blade.

MODEL NO.	PRICE EACH (MIN. 6)			H-595B EXTRA BLADES
	6	12	24+	
H-1001	\$2.30	\$2.20	\$2.10	\$9.95 100/pk.

Includes 1 blade

## ECONOMY CUTTERS



H-595



H-5838 SAFETY

Convenient and lightweight. Fits in your pocket.

- Durable metal casing. • Includes 1 blade. • Safety – Auto-retractable.

MODEL NO.	DESCRIPTION	QTY./ CTN.	PRICE PER CARTON (MIN. 2)				H-595B EXTRA BLADES
			2	4	6	12+	
H-595	Economy	12	\$12	\$11 per carton			\$9.95 100/pk.
H-5838	Safety		15	\$12 per carton			

# SAFETY KNIVES AUTO-RETRACTABLE

## COMFORT-GRIP



Rubberized handle. Includes 1 blade.

MODEL NO.	PRICE EACH (MIN. 6)				H-838B EXTRA BLADES
	6	12	24	48+	
H-1370	<b>\$5.40 each any quantity</b>				\$23 100/pk.

## COMFORT-GRIP SELF-RETRACTING



Blade retracts when lifted from cutting surface. Includes 1 blade.

MODEL NO.	PRICE EACH (MIN. 6)				H-838B EXTRA BLADES
	6	12	24	48+	
H-2403	\$7.20	\$6.90	\$6.65	\$6.40	\$23 100/pk.

## COMBO SAFETY KNIFE



COMBO

Auto-retractable or standard 3-position blade. Includes 4 blades.

MODEL NO.	PRICE EACH (MIN. 6)				H-838B EXTRA BLADES
	6	12	24	48+	
H-4304	\$8.95	\$8.70	\$8.20	\$7.95	\$23 100/pk.

## SLIDING SAFETY KNIFE



SPACESAVER

Retracts for safety. Fits in your pocket. Includes 1 blade.

MODEL NO.	PRICE EACH (MIN. 6)				H-838B EXTRA BLADES
	6	12	24	48+	
H-3758	\$7.70	\$7.45	\$7.15	\$6.90	\$23 100/pk.

## OLFA® SAFETY KNIFE



Lightweight and comfortable. Includes 1 blade.

MODEL NO.	PRICE EACH (MIN. 6)			H-1139B EXTRA BLADES
	6	12	24+	
H-1139	\$9.75	\$9.50	\$9.25	\$7.30 10/pk.

## MARTOR® MAXISAFE



GERMAN TECHNOLOGY

Ambidextrous thumb slide. Self-retracting. Includes 1 blade.

MODEL NO.	PRICE EACH			H-7255B EXTRA BLADES
	1	5	10+	
H-10365	\$26	\$25	\$24	\$9 10/pk.

## QUICKBLADE AUTO-RETRACTABLE



Quick change blade. Includes 1 blade.

MODEL NO.	PRICE EACH (MIN. 6)				H-838B EXTRA BLADES
	6	12	24	48+	
H-1140	\$8.70	\$8.45	\$8.20	\$7.95	\$23 100/pk.

## X-ACTO® KNIFE



Sharp blade allows for precise cutting.

- Nonslip textured grip. Aluminum barrel.
- Use on paper, plastic, cloth and film.
- Self-Healing Cutting Mats, see [uline.com](http://uline.com)



MODEL NO.	PRICE EACH (MIN. 6)			MODEL NO.	EXTRA BLADES
	6	12	24+		
H-998	\$4.60	\$4.50	\$4.35	H-998B H-4453	\$6.95 15/pk. 38.00 100/pk.



## ULINE UTILITY KNIVES

This high quality, heavy-duty knife easily cuts tape, cartons, strapping and twine. Zinc die cast.

- **Retractable** with 3 blade-locking positions for safety.
- Includes 3 heavy-duty blades.

SPECIFY COLOR:  Black  Green  Orange  Yellow

MODEL NO.	PRICE EACH (MIN. 6)				H-64B EXTRA BLADES
	6	12	24	48+	
H-64	\$5.60	\$5.35	\$5.10	\$4.85	\$18 100/pk.



## ULINE COMFORT-GRIP KNIVES

Softest, **most comfortable handles** we sell.

- Simple. Push button to change blade.
- Retractable with 3 blade positions.
- **Man's Knife** – Chubbied up to fit a man's hand.
- Includes 1 blade.



MODEL NO.	PRICE EACH (MIN. 6)				H-64B EXTRA BLADES
	6	12	24	48+	
H-1369	<b>\$4.40 each any quantity</b>				
H-2402	\$6.45	\$6.15	\$5.90	\$5.65	\$18 100/pk.



## E-Z GLIDE KNIVES

A unique spring-action slider provides the **smoothest operation of any Uline knife.**

- Retractable – 3 blade positions.
- Steel construction. • Includes 5 blades.

**FREE OFFER**  
Free Knife Pouch with a 24+ order of H-723 knives.



H-724

SPECIFY COLOR:  Green  Orange  Yellow  Gray

MODEL NO.	PRICE EACH (MIN. 6)				H-64B EXTRA BLADES
	6	12	24	48+	
H-723	\$5.10	\$4.85	\$4.60	\$4.35	\$18 100/pk.



## ULINE LIGHTWEIGHT KNIFE

Great for repeat use. 39% lighter than traditional knives.

- Lightning fast, push-button blade changes.
- Retractable – 3 blade positions.
- Includes 5 blades. • String cutter.

MODEL NO.	PRICE EACH (MIN. 6)				H-64B EXTRA BLADES
	6	12	24	48+	
H-2720	\$6.15	\$5.90	\$5.65	\$5.35	\$18 100/pk.

## REPLACEMENT BLADES

- Heavy-duty .025" blades.
- Fits Uline, Stanley, Ardell, Hyde, Hunt, Lutz, Fuller, Allway and other knife brands.



H-839

**FREE OFFER**  
**FREE H-839**  
Blade Disposal Container with 5+ boxes of blades.



H-64B

MODEL NO.	DESCRIPTION	PRICE PER PACK		
		1	2	5+
H-64B	100 Standard Blades	\$18	\$17	\$16
H-838B	100 Safety Blades	23	22	21
H-94	Disp./100 Standard Blades	20	19	18
H-839	Blade Disposal Container	\$16 each		



H-94

Blade dispenser mounts on wall. Easy blade release.



# VINYL ENVELOPES



Economical choice to protect your warranties, instruction books and other documents.

- Non-rip seams.
- Pre-punched hang hole. 8 mil vinyl.



SHORT SIDE OPENING

## COLOR CODED

Protect, color code and prioritize important work orders and other documents.



LONG SIDE OPENING

## 3-HOLE PUNCHED

Heavy-duty sheet protector with standard 3-ring binder holes.



## CLEAR SHORT-SIDE OPENING

MODEL NO.	USABLE SIZE W x L	SUGGESTED USE	PRICE PER CARTON OF 50		
			1	3	6+
S-16492	2 x 3½"	Business Cards	\$19	\$17	\$14
S-6014	2 x 4"	#2 Tag	20	18	15
S-6400	3 x 4"	#4 Tag	21	19	16
S-6015	3 x 5"	#5 Tag	22	20	17
S-5653	4 x 6"	Photos	\$17 per carton any qty.		
S-6016	4 x 8"	#8 Tag	24	22	19
S-25142	4 x 9"	Trifold Brochure	26	24	21
S-6401	5 x 7"	Instructions	25	23	20
S-5654	5 x 8"	Digest Books	26	24	21
S-5655	6 x 9"	Manuals and Catalogs	29	27	24
S-6402	7 x 10"		31	29	26
S-7108	8½ x 11"		32	30	27
S-5656	9 x 12"	Invoices, Memos and Forms	\$21 per carton any qty.		
S-6404	10 x 12"		34	32	29
S-6405	10 x 13"		35	33	31
S-6406	12 x 15"	Signs	56	54	49
S-6407	12 x 18"		59	57	52
S-6408	18 x 24"	Posters	103	99	92
S-21750*	24 x 36"	Artwork	185	180	175

\*No hang hole

## CLEAR LONG-SIDE OPENING

MODEL NO.	USABLE SIZE W x L	SUGGESTED USE	PRICE PER CARTON OF 50		
			1	3	6+
S-7109	5 x 3"	Index Cards	\$22	\$20	\$17
S-6409	6 x 4"	Photos	23	21	18
S-6410	8 x 4"	#8 Tag	24	22	19
S-6411	8 x 5"	Digest Books	26	24	21
S-6412	9 x 6"	Manuals	29	27	24
S-7126	11 x 8½"	Catalogs	32	30	27
S-6413	12 x 9"	Invoices	33	31	28
S-7110	12 x 10"	Large Forms	34	32	29
S-12326	18 x 12"	Signs	59	57	52

## COLOR CODED SHORT-SIDE OPENING

SPECIFY COLOR: Green, Yellow, Red or Blue

MODEL NO.	USABLE SIZE W x L	SUGGESTED USE	PRICE PER CARTON OF 50		
			1	3	6+
S-14737	9 x 12"	Invoices, Memos and Forms	\$35	\$33	\$30

## 3-HOLE PUNCHED

MODEL NO.	USABLE SIZE W x L	SUGGESTED USE	PRICE PER CARTON OF 50		
			1	3	6+
S-19947	8½ x 11"	Document Holder	\$34	\$32	\$29
S-21751	9 x 12"	Invoices, Memos and Forms	35	33	30



S-12324



S-12325

# DUAL POCKET JOB TICKET HOLDERS

Organize and route information without losing a page.

- Small pocket holds CDs, tags and smaller paperwork.
- Large pocket holds job tickets, brochures and catalogs.
- Heavy-duty vinyl with metal eyelet for hanging.

MODEL NO.	BACK POCKET W x L	FRONT POCKET W x L	MIL	QTY./CTN.	PRICE PER CARTON		
					1	3	6+
S-12324	9 x 12"	9 x 6"	8	50	\$92	\$88	\$85
S-12325	12 x 9"	12 x 4½"			93	89	86

# JOB TICKET HOLDERS

## SHORT-SIDE OPENING

SPECIFY COLOR: ■ Red ■ Black ■ Blue ■ Green ■ Yellow ■ Orange

MODEL NO.	INSIDE DIM. W x L	MIL	QTY./CTN.	LBS./CTN.	PRICE PER CARTON		
					1	3	6+
S-6013▲	4 x 6"	8	50	2	\$66	\$64	\$62
S-5497▲	5 x 8"			2	90	87	85
S-2760	6 x 9"			3	76	73	71
S-5498	8½ x 11"			4	93	90	87
S-2761	9 x 12"			5	<b>\$68 per carton any qty.</b>		
S-7111	11 x 14"			7	110	105	100
S-6766▲	11 x 17"			7	160	155	150
S-3226	12 x 15"			8	135	122	101
S-12412	12 x 18"			10	151	137	116
S-6414▲	15 x 18"			10	195	180	165

ALSO AVAILABLE IN PINK AND PURPLE ▲ SINGLE EYELET

## LONG-SIDE OPENING

MODEL NO.	INSIDE DIM. W x L	MIL	QTY./CTN.	LBS./CTN.	PRICE PER CARTON		
					1	3	6+
S-5511▲	9 x 6"	8	50	3	\$102	\$100	\$97
S-5512	12 x 9"			5	99	95	92
S-6415▲	15 x 12"			7	170	155	140

▲ SINGLE EYELET

## ASSORTMENT PACK

Short-side opening.



5 each: Red Black Blue Green Yellow Orange

MODEL NO.	INSIDE DIM. W x L	MIL	QTY./CTN.	LBS./CTN.	PRICE PER CARTON		
					1	3	6+
S-2774	9 x 12"	8	30	3	\$66	\$63	\$61

## RECLOSABLE

Zip closure prevents dirt, water and debris from damaging important documents.

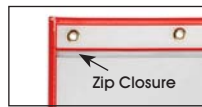

SPECIFY COLOR: Red, Black, Blue or Green

MODEL NO.	INSIDE DIM. W x L	MIL	QTY./CTN.	LBS./CTN.	PRICE PER CARTON		
					1	3	6+
S-22348	9 x 12"	8	50	5	\$99	\$95	\$92
S-22349	11 x 14"	8	50	7	103	99	96



S-2761

Fluorescent colors call attention to job orders, low inventories or important instructions.

- Heavy-duty 8 mil vinyl.
- Metal eyelets for hanging.
- Durable vinyl-stitched seams.
- Clear both sides.
- Job Ticket Racks, see page 656.



SHORT-SIDE OPENING



LONG-SIDE OPENING

## SOLID BACK JOB TICKET HOLDERS

Documents stand out against colored background.



SPECIFY COLOR: Black or Red

MODEL NO.	INSIDE DIM. W x L	MIL	QTY./CTN.	LBS./CTN.	PRICE PER CARTON		
					1	3	6+
S-14735	9 x 12"	8	50	8	\$120	\$118	\$115

SINGLE EYELET

# DELUXE JOB TICKET HOLDERS

Convenient hanging strap loops over hooks and machinery.

- Tough 20 mil vinyl keeps paperwork flat.
- Short-side opening.
- Reusable, long-lasting, portable.

SPECIFY COLOR: Red, Black, Blue or Green

MODEL NO.	INSIDE DIM. W x L	MIL	QTY./CTN.	LBS./CTN.	PRICE PER CARTON		
					1	3	6+
S-10508	9 x 12"	20	25	6	\$71	\$67	\$63
S-10509	11 x 14"	20	25	8	77	73	69



# JOB JACKETS

Keep job documents moving safely between departments.

MODEL NO.	INSIDE DIM. W x L x H	MIL	QTY./CTN.	LBS./CTN.	PRICE PER CARTON		
					1	3	6+
S-12423	9 x 12 x 1"	13	25	6	\$67	\$63	\$60
S-10504	12 x 13 x 1"	13	25	8	74	70	66

- Gusseted vinyl jacket expands to hold up to 2" of folders and binders.
- Tough 13 mil vinyl.
- Durable stitched seams.



# MAGNETIC VINYL ENVELOPES



Position on racking or machinery. Easy to move from bay to bay.

- 2 magnetic strips keep envelopes secure.
- Works well with barcode systems.
- Durable non-rip seams.
- Will not scratch racking. • Tough 8 mil vinyl.

MODEL NO.	USABLE SIZE H x W	QTY./ CARTON	PRICE PER CARTON		
			1	5	10+
S-6739*	1 x 4"	50	\$32	\$28	\$25
S-3831*	2½ x 3½"		36	34	32
S-3832	3 x 5"		<b>\$32 per carton any quantity</b>		
S-6380	3 x 8"		66	63	60
S-3833	4 x 6"	50	<b>\$43 per carton any quantity</b>		
S-6740	4 x 9"		84	78	75
S-25105	4¼ x 11"		89	85	81
S-6381▲	5 x 3"		57	53	51
S-5006	5 x 8"		81	75	73
S-6382▲	6 x 4"		63	58	56
S-6741	6 x 9"	79	76	71	
S-7149	8½ x 11"	107	103	99	
S-3834	9 x 11½"	111	107	103	
S-7150	9 x 12"	115	110	105	
S-21788	11 x 17"	205	200	195	

▲ Long-side opening

\* 1 magnetic strip per envelope

# RECLOSABLE VINYL ENVELOPES



Protect important documents from job site conditions. **Waterproof and weatherproof.** Hang hole on top.

- Heavy-duty 8 mil vinyl resists tears and punctures.

## SHORT-SIDE OPENING

MODEL NO.	USABLE SIZE W x L	SUGGESTED USE	PRICE PER CARTON OF 50		
			1	3	6+
S-7112	3 x 5"	#5 Tag	\$37	\$35	\$32
S-7113	4 x 6"	Photos	42	39	36
S-16490	5 x 7"	Instructions	46	44	41
S-7114	6 x 9"	Manuals	54	51	48
S-7115	8½ x 11"	Invoices, Memos and Forms	69	66	63
S-7116	9 x 12"		71	68	65
S-7713	10 x 13"		81	78	74
S-7714	12 x 15"	Signs	97	93	89

# VELCRO®/SNAP VINYL ENVELOPES



Protect warehouse documents from dust, dirt and debris.

**Velcro® Closure** – Quick access with convenient fold-over flap.

**Snap Closure** – Secure locking with convenient fold-over flap.

## VELCRO® CLOSURE

MODEL NO.	USABLE SIZE W x L	SUGGESTED USE	QTY./ CARTON	PRICE PER CARTON		
				1	3	6+
S-7708	4 x 6"	Photos	50	\$41	\$39	\$37
S-7709	6 x 9"	Manuals		52	50	47
S-7710	9 x 12"	Invoices and Memos	50	75	72	70

## SNAP CLOSURE

MODEL NO.	USABLE SIZE W x L	SUGGESTED USE	QTY./ CARTON	PRICE PER CARTON		
				1	3	6+
S-22350	4 x 6"	Photos	50	\$44	\$42	\$40
S-22351	6 x 9"	Manuals		55	53	50
S-22352	9 x 12"	Invoices and Memos	50	72	69	66



# RECLOSABLE PRESS-ON VINYL ENVELOPES

Post and protect instructions, warnings and maintenance logs.

- Stick directly to equipment, cabinets, walls and doors.
- Weatherproof and waterproof.
- Sturdy 8 mil clear vinyl.

MODEL NO.	USABLE SIZE W x L	SUGGESTED USE	QTY./ CARTON	PRICE PER CARTON		
				1	3	6+
S-16499	3 x 5"	#5 Tag	50	\$41	\$39	\$36
S-15594	4 x 6"	Photos		66	62	58
S-15595	6 x 9"	Manuals		87	82	77
S-21779	8½ x 11"	Documents		115	113	110
S-15596	9 x 12"	Notices		131	123	115



# PRESS-ON VINYL ENVELOPES

## SHORT-SIDE OPENING

MODEL NO.	USABLE SIZE H x W	SUGGESTED USE	PRICE PER CARTON OF 50			
			1	5	20	60+
S-7695	1 x 4"	Binders	\$23	\$21	\$20	\$18
S-3227	2 x 3½"	Business Cards	22	20	19	17
S-2956	3 x 5"	Index Cards	\$21 per carton any quantity			
S-5003	4 x 4"	Comp. Disks	34	32	30	28
S-3228	4 x 6"	Photos	40	38	35	34
S-5004	4 x 8"	Gen. Purpose	44	40	38	36
S-5005	5 x 5"	CD Holder	39	37	35	33
S-10495	5 x 7"	Photos	44	40	38	36
S-3229	5 x 8"	Warranty Cards	45	42	39	38
S-2957	6 x 9"	Instructions	46	44	41	40
S-2959	8½ x 11"	Letter Size Docs.	74	69	63	61
S-21746	8½ x 14"	Legal Size Docs.	81	76	70	67
S-7152	9 x 12"	Notices	76	71	65	62
S-21747	11 x 17"	Posters	105	100	96	92
S-10496	12 x 18"	Signs	105	100	93	90



Display inventory tags, job tickets and warranty cards.

- Guaranteed non-rip seams.
- Adheres to any smooth surface.
- Tough 8 mil vinyl.
- Suitable for use with barcode scanners.
- Side loading unless otherwise shown.

## LONG-SIDE OPENING

MODEL NO.	USABLE SIZE H x W	SUGGESTED USE	PRICE PER CARTON OF 50			
			1	5	20	60+
S-7696	3½ x 2"	Business Cards	\$22	\$20	\$19	\$17
S-7151	4 x 3½"	Comp. Disks	33	31	29	27
S-5668	5 x 3"	Index Cards	32	30	28	26
S-5669	6 x 4"	Photos	40	38	35	33
S-6383	8 x 5"	Warranty Cards	45	42	39	38
S-6384	9 x 6"	Instructions	46	44	43	40
S-6017	11 x 8½"	Letter Size Docs.	74	69	63	61
S-21748	18 x 12"	Signs	115	109	103	100

Short-Side Opening:



S-3227  
Business Cards

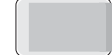

S-2956  
Index Cards



S-5005  
CDs

Long-Side Opening:



S-7696  
Business Cards



S-7151  
Computer Disks



S-5669  
Photos

# LABEL HOLDER STRIPS

Customize the size of your label holders with these handy strips.

- Cut adhesive-backed plastic strips to desired size.
- Bottom load design allows easy access.
- Holds signs, labels and papers up to 8½ x 11".

MODEL NO.	SIZE W x L	SPECIFY COLOR	QTY./PACK	PRICE PER PACK		
				1	5	10+
S-7748	1 x 36"	White or Black	6	\$34	\$32	\$30
S-21749	1 x 48"			41	38	36
S-7749	1¼ x 48"			45	42	39
S-7750	2 x 48"			56	53	50



# INSERT CARDS

MODEL NO.	CARD SIZE	CARDS/SHEET	CARDS/PACK	PRICE/PACK	MODEL NO.	CARD SIZE	CARDS/SHEET	CARDS/PACK	PRICE/PACK
S-7697	1/2 x 3"	36	360	\$14	S-6743	3 x 5"	4	200	\$22
S-7698	1 x 3"	18	450	16	S-7702	3 x 6"	3	150	
S-15618	1 x 4"	20	500		S-6744	3 x 8"	3	150	
S-7699	1 x 6"	9	225	S-6745	4 x 6"	2	100		
S-6742	2 x 3"	8	400	S-7703	4 x 8"	2	100		
S-15619	2 x 4"	10	500	22	S-6746	5 x 8"	2	100	
S-7700	2 x 6"	4	200		S-6747	8½ x 11"	1	50	
S-7701	3 x 4"	6	300						

Use with Uline's vinyl envelopes and label holder strips.

- Perforated on 8½ x 11" sheets.
- 60 lb. cardstock.
- Compatible with laser and inkjet printers.



# MAGNETIC TAPE

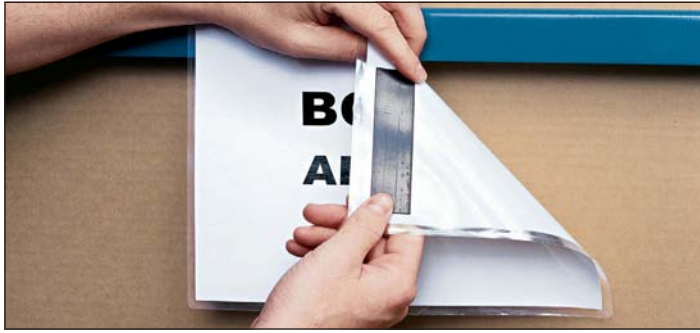

Mount warehouse signs and laminated sheets of location markers to metal racking, file cabinets or doors.



- Make a magnetic sign in seconds!
- Adhesive on one side, magnetic on the other.
- Extra-thick magnet has super holding power.
- Easy-to-use tape cuts with scissors.

**ROLLS** – Scissor cut to desired length.

MODEL NO.	SIZE W x L	THICKNESS	LBS./ ROLL	PRICE PER ROLL		
				1	2	5+
S-6807	1/2" x 100'	.06"	5	\$59	\$56	\$49
S-20008	3/4" x 100'		7	80	76	70
S-6808	1" x 50'		5	59	56	49
S-7705	2" x 50'		9	98	94	87
S-12292	3" x 50'		15	129	123	115
S-21784	4" x 50'		21	131	125	117

**PERFORATED ROLLS** – Pre-scored to popular lengths.

MODEL NO.	SIZE W x L	THICKNESS	QTY./ ROLL	PRICE PER ROLL		
				1	2	5+
S-15591	1" x 3" x 50'	.06"	200	\$72	\$69	\$63
S-15592	2" x 4" x 50'		150	114	109	99

**STRIPS** – Save time cutting rolls.

MODEL NO.	SIZE W x L	THICKNESS	QTY./ PACK	PRICE PER PACK		
				1	2	5+
S-20009	2 x 3 1/2"	.03"	100	\$59	\$56	\$49
S-20010	4 x 6"		50	94	90	83
S-20011	8 1/2 x 11"		25	114	109	99

# MAGNETIC SHEETS



Quickly create warehouse signs or labels.

- Magnetic-backed sheets print easily from your inkjet or laser printer.
- Lightweight and easy to use.

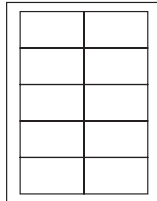

S-7720 and S-19176

**S-7720 and S-19176** – 10 scored 3 1/2 x 2" labels.

**INKJET PRINTABLE**

SPECIFY FINISH: Glossy or Matte

MODEL NO.	LABEL SIZE W x H	LABELS/ SHEET	LABELS/ PACK	PRICE PER PACK		
				1	2	5+
S-7706	8 1/2 x 11"	1	10	\$24	\$23	\$21
S-7720	3 1/2 x 2"	10	100	27	26	24

**LASER PRINTABLE**

Matte Only

MODEL NO.	LABEL SIZE W x H	LABELS/ SHEET	LABELS/ PACK	PRICE PER PACK		
				1	2	5+
S-19175	8 1/2 x 11"	1	10	\$28	\$27	\$25
S-19176	3 1/2 x 2"	10	100	31	30	28

# PLASTIC LABEL HOLDERS



CARDS INCLUDED

Use these handy holders on racking, shelves, bins and file cabinets.

- Tough plastic sleeve won't chip, crack or tear.
- Easy to slide insert sheets in and out.
- Non-glare finish.

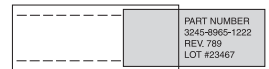

PART NUMBER  
3245-8965-1222  
REV. 789  
LOT #23467

**ADHESIVE BACK**

MODEL NO.	SIZE H x W	PRICE PER PACK OF 25		
		1	5	10+
S-6386	1/2 x 6"	\$28	\$25	\$23
S-6387	3/4 x 6"	32	29	27
S-15588	1 x 3"	28	25	23
S-6388	1 x 6"	36	33	31
S-21785	2 x 3"	32	29	27
S-6389	2 x 6"	48	44	41
S-21786	3 x 5"	47	43	40

**MAGNETIC BACK**

S-15589	1 x 3"	\$31	\$28	\$26
S-6392	1 x 6"	37	34	32
S-6393	2 x 6"	63	58	54

# WET ERASE MARKERS



Fine tip markers for magnetic warehouse labels.

**Assorted** – Includes 1 black, blue, green and red marker.

MODEL NO.	COLOR	TIP	QTY./ PACK	PRICE PER PACK		
				1	2	4+
S-16511	Black	Fine	12	\$21	\$20	\$19
S-21787	Assorted	Fine	4	N/A	8	7

# MAGNETIC WAREHOUSE LABELS

Easily relocate labels when you move inventory.

- **Reusable** – Wet cloth wipes off writing from vinyl surface.

**ROLLS** – Scissor cut to desired length.

MODEL NO.	SIZE	THICKNESS	COLOR	PRICE PER ROLL			LBS./ ROLL
				1	2	5+	
S-21711	1/2" x 100'	.03"	White	\$51	\$49	\$43	3
S-5672W	1" x 100'	.06"	White	69	64	57	9
S-5672Y	1" x 100'		Yellow	78	72	62	10
S-7148	1" x 50'	.03"	White	39	36	32	3
S-5673	1" x 200'			100	86	80	9
S-5657*	1" x 200'	.03"	Yellow, Orange, Red, Blue or Green	110	96	90	11
S-5658*	2" x 200'			149	137	121	21
S-21712	2" x 100'	.03"	White	88	82	72	10
S-5674	2" x 200'			131	119	103	21
S-5675	3" x 200'			161	152	140	31
S-5676	4" x 200'			204	194	180	38
S-21715	6" x 200'			279	277	271	57

\*Specify color when ordering

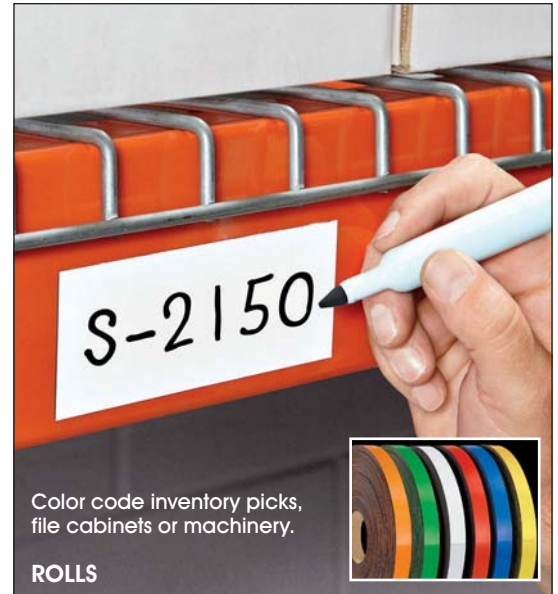

**PERFORATED ROLLS** – Pre-scored to popular lengths.

MODEL NO.	SIZE	THICKNESS	COLOR	QTY./ ROLL	PRICE PER ROLL			LBS./ ROLL
					1	2	5+	
S-21716	1/2" x 3" x 100'	.03"	White	400	\$55	\$52	\$48	5
S-10403	1" x 3" x 100'			400	60	57	53	5
S-9953	1" x 4" x 100'			300	60	57	53	5
S-7690	1" x 6" x 100'			200	60	57	53	5
S-7691W	2" x 4" x 100'	.03"	White	300	75	72	68	10
S-10494	2" x 6" x 100'			200	75	72	68	10
S-7692	3" x 5" x 100'			240	98	94	90	14
S-24744	4" x 4" x 100'	.03"	White	300	118	113	108	20
S-12290	4" x 6" x 100'			200	118	113	108	20

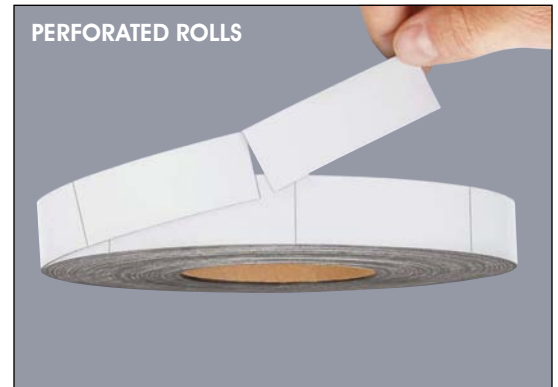

**STRIPS** – Save time cutting rolls.

MODEL NO.	SIZE	THICKNESS	COLOR	QTY./ PACK	PRICE PER PACK			LBS./ PACK
					1	2	5+	
S-5659	1 x 2"	.03"	White	100	\$15	\$13	\$12	1
S-15770	1 x 3"				21	19	17	1
S-7687	1 x 4"				27	25	23	2
S-5660	1 x 6"				32	29	27	3
S-5661	2 x 3"	.03"	White	100	32	29	27	3
S-6007	2 x 4"				36	33	31	4
S-7688	2 x 6"				46	43	41	4
S-6125	3 x 5"				58	52	48	6
S-7689	4 x 6"	.03"	White	100	73	68	62	10



**C-CHANNEL** – Use for neat and easy marking of racking, file cabinets or shelves.

MODEL NO.	SIZE	THICKNESS	PRICE PER CTN. OF 25			MODEL NO.	SIZE	THICKNESS	PRICE PER CTN. OF 25		
			1	2	5+				1	2	5+
S-7693	1/2 x 3"	.06"	\$18	\$16	\$13	S-6420	2 x 6"	.06"	\$37	\$34	\$30
S-6421	1 x 3"		20	18	15	S-6422	3 x 4"		37	34	30
S-6423	1 x 6"		26	24	21	S-12291	3 x 5"		46	43	39
S-6425	2 x 3"		26	24	21	S-6424	3 x 6"		51	48	44
S-15772	2 x 4"		30	27	24	S-7694	3 x 8"		67	64	60

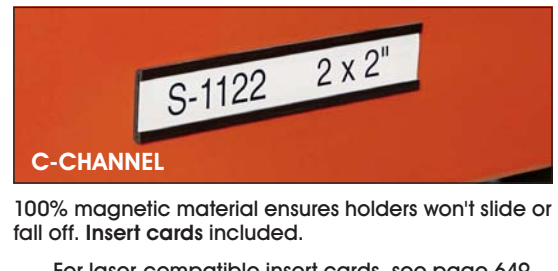



# VINYL WAREHOUSE LABELS

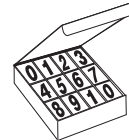
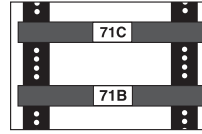

S-6008 Kit

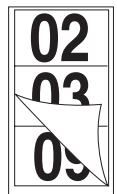

S-7704 double digit numbers

\* Specify each letter or number. Example: S-5662-1, S-5663-B.

MODEL NO.	DESCRIPTION	SPECIFY LETTER OR NUMBER	QTY./PACK	PRICE PER PACK		
				1	2	5+
S-5662*	3 1/2" Single Number	0-9	50	\$10	\$9	\$8
S-5663*	3 1/2" Single Letter	A-Z				

Label your warehouse racks and equipment.

- Tough vinyl with permanent adhesive backing.
- Kits: Simplify your labeling project with one of Uline's complete letters or numbers kits.

## KITS

MODEL NO.	DESCRIPTION	CONTENTS	QTY./CTN.	PRICE PER CARTON		
				1	2	5+
S-14679	2" Numbers	100 ea. of 1 and 0, 50 ea. of 2-9	600	\$77	\$72	\$67
S-6008	3 1/2" Numbers			94	90	84
S-7704	3 1/2" Double Digit Numbers	One each of 00-99	100	90	86	80
S-14680	2" Letters	50 ea. of A-Z	1,300	170	160	150
S-7153	3 1/2" Letters			195	185	165

# WAREHOUSE AISLE SIGN KIT



Create aisle signs for your warehouse or storeroom.

- Holders snap into standard pallet racks with 2" hole spacing. Flexible holders bend to prevent damage when hit.
- 11 x 8 1/2" yellow paper inserts print on laser printers.

MODEL NO.	SIZE W x H	KIT INCLUDES	PRICE EACH		
			1	3	5+
S-14803	11 x 8 1/2"	10 Holders, 12 Yellow Card Inserts	\$34	\$32	\$30

# REMOVABLE ADHESIVE LABELS



Mark racks, shelving and products without leaving a sticky residue.

- Lifts cleanly without tearing.
- Easy to write on.

MODEL NO.	SIZE H x W	COLOR	QTY./ROLL	PRICE PER 1,000		
				1	2	6+
S-5638W	2 x 3"	White	500	\$38	\$37	\$34
S-5639W	2 x 4"			42	41	38
S-5640W	3 x 4"			59	58	53

# MAGNETIC AISLE SIGNS



Place in busy warehouse areas to control traffic and maintain safety.

- "L" shape sign projects 90° from wall. Visible from either side.
- Strong magnetic strip easily adheres to any steel surface.



MODEL NO.	DESCRIPTION	SIZE	PRICE EACH		
			1	3	5+
S-22489	Stop	12 x 12"	\$30	\$28	\$26
S-25256	Fire Extinguisher	18 x 4"			

# DOCK DOOR SIGNS



Find the right dock door to keep inbound and outbound freight moving.

**Indoor** – Durable PVC plastic. Includes 4 strips of double-sided tape.

**Outdoor** – Reflective, UV and weather-resistant aluminum.

Pre-drilled mounting holes Specify number range (1-10, 11-20, 21-30)

MODEL NO.	DESCRIPTION	MATERIAL	SIZE W x H	SIGNS PER SET	PRICE PER SET
S-23468	Indoor	Plastic	12 x 12"	10	\$100
S-23469	Outdoor	Aluminum	18 x 18"		285



## HEAVY DUTY AISLE SIGNS

Find the right warehouse aisle quickly.

Durable, white PVC plastic.

- L-Bend: Extend from aisle ends. Attach with tape, screws or cable ties.
- Flat: 2 pre-drilled mounting holes for hanging.

**Numbered/Lettered Signs** – Large, easy-to-read characters on both sides.

**Blank Signs** – Create your own unique system with 8" Die-Cut Letters and Numbers (sold separately).

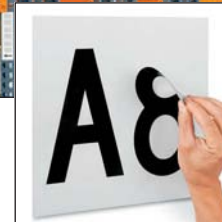

### NUMBERED SIGNS

Specify number range (1-10, 11-20 or 21-30)

MODEL NO.	DESCRIPTION	SIZE	SIGNS PER SET	PRICE PER SET
S-15740	L-Bend	12 x 12"		\$140
S-15741	Flat	12 x 12"	10	115
S-15742	Flat	24 x 24"		199

### BLANK SIGNS

Use with Die-Cut Labels (below)

MODEL NO.	DESCRIPTION	SIZE	SIGNS PER SET	PRICE PER SET
S-23446	L-Bend			\$70
S-23447	Flat	12 x 12"	10	60

### LETTERED SIGNS

Specify letter range (A-M or N-Z)

MODEL NO.	DESCRIPTION	SIZE	SIGNS PER SET	PRICE PER SET
S-23444	L-Bend	12 x 12"	13	\$200
S-23445	Flat			180

### DIE-CUT LABELS

MODEL NO.	DESCRIPTION	SPECIFY LETTER OR NUMBER	QTY./PACK	PRICE PER PACK		
				1	2	5+
S-23448	8" Single Number	0-9	5	\$20	\$19	\$18
S-23449	8" Single Letter	A-Z				

## MAGNETIC SIGN HOLDERS



Warehouse safety is of the utmost importance today.

- Use on machinery, dry erase boards and breakroom fridges.
- Magnetic strips secure document in place.
- Durable 10 mil anti-glare PVC.

SPECIFY COLOR: Black, Blue, Red, Green or Black/Yellow

MODEL NO.	DESCRIPTION	USABLE SIZE W x H	QTY./PACK	PRICE PER PACK		
				1	3	5+
S-24766	Magnetic Holder	8½ x 11"	5	\$44	\$42	\$40

## WORKPLACE DECALS

New

Post important messages and safety reminders.

- Label equipment and machinery.
- Tough, 4 mil vinyl.
- UV resistant. Lasts 5 years without fading.



Additional messages, see uline.com

Specify size

MATERIAL	SIZE	QTY./PACK	PRICE PER PACK		
			1	3	5+
Adhesive Vinyl	3½ x 5"	5	\$20	\$19	\$18
	5 x 7"		25	24	23

## MAGNETIC HOOKS



Hang it where you need it. Organize your workspace for safety and efficiency.

**Carabiner** – Secure small tools with quick-locking fastener.

**Split Key Ring** – Keep keys secure and organized. 1" ring.

**Hook** – Hang anything and everything – from light tools to cords.

\* SPECIFY COLOR: Black or White

MODEL NO.	DESCRIPTION	SIZE (DIAM.)	CAPACITY (LBS.)	PRICE EACH (MIN. 2)		
				2	6	12+
S-23103	Carabiner	1½"	35	\$12	\$11	\$10
S-23104	Split Key Ring	1½"	35	10	9	8
S-23105*	Hook	1½"	70	12	11	10

## SWIVEL MAGNETIC HOOK

Super strong. Holds up to 65 pounds.

- Hook swivels 360°. Swings out 180°.
- Hang job ticket holders, tools or cables.
- Job ticket holders, see page 647.



MODEL NO.	SIZE (DIAM.)	CAPACITY (LBS.)	PRICE EACH (MIN. 2)		
			2	6	12+
S-20012	1½"	65	\$16	\$15	\$14



S-19260

## PROJECTING SIGNS

Locate emergency equipment immediately.

- Recommended for warehouses, factories, hospitals and schools.
- Moisture resistant. Will not rust or corrode.
- 2-Way Sign – "L" shape projects 90° from wall. Easily visible from either side.
- 3-Way Sign – "V" shape projects 45° from wall. Easily visible from front and sides.
- PVC plastic with pre-drilled mounting holes and adhesive tape included.
- Additional Projecting Signs, see [uline.com](http://uline.com)



S-24742



S-22474



S-21990



S-24743

MODEL NO.	DESCRIPTION	STYLE	SIZE H x W x D	PRICE EACH		
				1	3	5+
S-24742		3-Way	6¾ x 8 x 5½"	\$28	\$26	\$24
S-19259	Fire Extinguisher	2-Way	18 x 1 x 4"	25	23	21
S-19260		3-Way	18 x 8 x 3"	31	29	27

MODEL NO.	DESCRIPTION	STYLE	SIZE H x W x D	PRICE EACH		
				1	3	5+
S-22474	Spill Kit					
S-21990	AED Equipment	3-Way	6¾ x 8 x 5½"	\$28	\$26	\$24
S-24743	First Aid					

## PLASTIC RESTROOM SIGNS



S-15599



S-14804



S-14805



S-14806



S-15597



S-15598



S-23691

Easy-to-read signs for restroom doors.

- All signs have braille characters to meet ADA regulations.
- 1/8" thick injection-molded plastic.
- Double-sided mounting tape included.

SPECIFY COLOR: Black or Blue

MODEL NO.	SIZE H x W	PRICE EACH		
		1	3	5+
S-14804 to S-23691	9 x 6"	\$19	\$18	\$17

## WORKPLACE SIGNS



S-9963



S-23486



S-17342



S-17343



S-21755



S-18791

Keep your workplace safe, clean and organized.

Vinyl – Tough 4 mil flexible vinyl with adhesive backing.

Plastic – Sturdy .055"-thick HDPE. Pre-drilled mounting holes and 4 strips of double-sided mounting tape.

Aluminum – Corrosion resistant with engineer-grade reflective enamel finish. Pre-drilled mounting holes.

MATERIAL	SIZE	USE	PRICE EACH		
			1	3	5+
Adhesive Vinyl	7 x 10"	Indoor Light Duty	\$10	\$9	\$8
Plastic	7 x 10"	Indoor/Outdoor Medium Duty	17	16	15
Aluminum	12 x 18"	Indoor/Outdoor Heavy Duty	32	30	28



# WORKPLACE SIGNS



S-14801\*



S-16453



S-14796



S-15593



S-9960



S-19207



S-16156



S-19208 RIGHT  
S-19209 LEFT



S-9959



S-20309



S-20307



S-24758



S-16154



S-17346



S-17347



S-19211



S-14799



S-18795



S-21754



S-17345



S-16452



S-20311



S-9962



S-19212

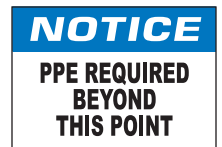

S-24762



S-23121



S-23122



S-19213



S-18793



S-9961



S-16451



S-18792



S-23117



S-14797



S-18796



S-19214



S-17344

Keep your workplace safe, clean and organized.

Vinyl – Tough 4 mil flexible vinyl with adhesive backing.

Plastic – Sturdy .055"-thick HDPE. Pre-drilled mounting holes and 4 strips of double-sided mounting tape.

Aluminum – Corrosion resistant with engineer-grade reflective enamel finish. Pre-drilled mounting holes.

MATERIAL	SIZE	USE	PRICE EACH		
			1	3	5+
Adhesive Vinyl	7 x 10" 18 x 4**	Indoor Light Duty	\$10	\$9	\$8
Plastic	7 x 10" 18 x 4**	Indoor/Outdoor Medium Duty	17	16	15
Aluminum	12 x 18" 18 x 4**	Indoor/Outdoor Heavy Duty	32 27	30 25	28 23

\*Size only available for S-14801

# HEAVY-DUTY BIN STORAGE CABINETS

Built like a vault. Tough enough to withstand years of heavy use.

- All-welded 14-gauge steel cabinet. Durable powder-coat finish.
- Bins hang and adjust on louvered panels.
- Shelves hold up to 1,000 lbs.
- Padlockable handle.
- 4" deep reinforced pocket doors.
- Raised, forkliftable base. Bolt to floor for extra stability.



H-9988



H-9989

## 126 Bin Cabinet

- (72) 5½ x 4 x 3"
- (48) 7½ x 4 x 3"
- (6) 15 x 16½ x 7"
- (3) Adjustable shelves

SPECIFY BIN COLOR: Yellow, Blue, Red, Green, White, Clear or Black

MODEL NO.	DESCRIPTION	NO. OF SHELVES	DIMENSIONS W x D x H	WT. (LBS.)	PRICE EACH	
					1	2+
H-9988	126 Bin Cabinet	3	48 x 24 x 78"	497	\$2,810	\$2,715
H-9989	168 Bin Cabinet	0	48 x 24 x 78"	471	2,690	2,595

Complete line, see [uline.com](http://uline.com)

SHIPS ASSEMBLED VIA MOTOR FREIGHT

## 168 Bin Cabinet

- (72) 5½ x 4 x 3"
- (48) 7½ x 4 x 3"
- (24) 11 x 5½ x 5"
- (18) 15 x 8 x 7"
- (6) 15 x 16½ x 7"

## JOB TICKET RACKS



Widely used for work order organizing and job tickets.

- For factories, repair shops and service departments.
- Oversized pockets to hold up to 9 x 12" job ticket holders.
- Durable steel construction with powder-coat finish.

SPECIFY COLOR: Black or Red

MODEL NO.	DIMENSIONS W x D x H	POCKETS	WT. (LBS.)	PRICE EACH	
				1	3+
H-9982	14½ x 2 x 26"	5	10	\$70	\$65
H-8497	14½ x 2 x 40"	9	16	90	85

## LED WALL PACK

Illuminate outdoor entrances, walkways and parking lots.

- Keep out bugs and rain. Fully sealed glass lens.
- Long lasting, built-in LED. Lasts up to 17 years.
- Hard wiring required.
- Meets safety standards for wet locations.



UL/C-UL Listed

MODEL NO.	DIMENSIONS W x D x H	WATTS	LUMENS	COLOR	RATED HOURS	PRICE EACH	
						1	2+
H-9996	14 x 7½ x 9½"	50	7,100	Daylight (5000K)	50,000	\$110	\$105



## MAGLINER® POWERED STAIR CLIMBER

Haul large and bulky loads up and down steps. Well worth the investment.

- Battery-powered motor provides smooth operation over steps. Up to 300 steps per charge. Battery and charger included.
- Dual-speed control. Climbs up to 29 steps per minute.
- Lightweight aluminum frame with 10" pneumatic wheels.
- Ergonomic handle with multiple grip positions.

Replacement battery, see [uline.com](http://uline.com)

SHIPS ASSEMBLED VIA MOTOR FREIGHT

MODEL NO.	DESCRIPTION	LOAD CAPACITY (LBS.)	WHEEL TYPE	NOSE PLATE	WT. (LBS.)	PRICE EACH
H-9272	Stair Climber	375	10" Pneumatic	18 x 9"	48	\$4,550

## POWER DRIVE



For info, see [uline.com](http://uline.com)

MAGLINER®

MODEL NO.	PRICE EACH
H-9379	\$4,800

# GLOW IN THE DARK SIGNS

Highly visible. Assist with emergency evacuation in power outages.

- Glow for 6+ hours. No power or batteries needed.
- Flexible 10 mil polyester.
- Peel-and-stick adhesive backing.



MODEL NO.	SIZE H x W	PRICE EACH		
		1	3	5+
S-15600 to S-19219	7 x 10"	\$16	\$15	\$14
S-15603 Fire Extinguisher	18 x 4"			



S-15603  
18 x 4"

# GLO BRITE® EXIT SIGNS

\$0 energy costs. Latest technology is 100% reliable for 25 years.

- Self-powered, glow-in-the-dark signs absorb and store ambient light.
- Remains visible for 1.5 hours during blackout conditions.
- Single sided. Ceiling or wall mount. Hardware included.

GLO BRITE®



SPECIFY COLOR: Red or Green

MODEL NO.	VIEWING DISTANCE	RECOMMENDED FOR	SIZE W x H x D	PRICE EACH		
				1	3	5+
H-6506	50'	Offices, Stores	16 x 9 x 1"	\$138	\$134	\$130
H-6507	100'	Warehouses, Airports		159	155	151

UL/C-UL LISTED

# ALUMINUM HARD-WIRED EXIT SIGNS



Upscale look for commercial buildings, fine restaurants and hotels.

- Single or double-sided signs can be ceiling, wall or flush mounted. Arrows snap out.
- 1.5 hour back-up battery for power outages. Battery automatically recharges.
- Bright long-life LED never needs changing. **Hard-wired** units stay lit.
- Die-cast aluminum construction.



120/277 VAC. UL LISTED.

MODEL NO.	DESCRIPTION	LETTER COLOR	SIZE H x W x D	PRICE EACH		
				1	3	5+
H-9980	Aluminum	Red	9 x 13 x 2"	\$145	\$135	\$125
H-9981		Green				

# HARD-WIRED EXIT SIGNS



Safely mark all exits, even in power failures.

- Single or double-sided signs can be ceiling, wall or flush mounted. Arrows snap out.
- 1.5 hour back-up battery for power outages. Battery automatically recharges.
- Bright long-life LED never needs changing. **Hard-wired** units stay lit.

With Emergency Lights – High intensity, adjustable LED lamps go on when the power goes off.

120/277 VAC. UL LISTED.

MODEL NO.	DESCRIPTION	LETTER COLOR	SIZE H x W x D	PRICE EACH		
				1	3	5+
H-1663	Plastic	Red	7 7/8 x 12 x 1 3/4"	\$50	\$48	\$45
H-9045	Plastic w/ Lights		8 1/2 x 21 x 4"	115	105	95

# LED EMERGENCY LIGHTS

Lights go on when the power goes off.

- Each high intensity LED lights a large 8 x 40' path.
- **Hard-wired** unit automatically recharges battery.
- 1.5 hour back-up battery for power outages.

Plastic – For office, restaurant and retail areas.

Steel – Heavy duty for warehouses, schools and manufacturing facilities. 4 hour back-up battery.

120/277 VAC. UL LISTED.

MODEL NO.	DESCRIPTION	SIZE H x W x D	PRICE EACH		
			1	3	5+
H-7260	Plastic	4 1/2 x 12 1/2 x 3 1/2"	\$60	\$57	\$54
H-7261	Heavy-Duty Steel	12 x 13 1/8 x 3 3/4"	180	170	160







Highly efficient, longer lasting LEDs will reduce your energy and maintenance expenses. Uses your existing fixtures.

**Type A** – Simple "plug-and-play" installation. Compatible with instant-start electronic ballasts.

- **Glass** – Distributes light evenly. For offices and warehouses.
- **Plastic** – For schools, food processing and manufacturing plants. Shatterproof, NSF certified.

**Type B** – Eliminate ballast compatibility and failure issues. **Rewiring required.**

**Screw-In Bulbs** – Last up to 12 times longer than incandescent bulbs.

- **A19** – Fits any household or office lamp socket.
- **BR30/BR40** – For can and recessed lighting. Dimmable.
- **PAR38** – For dock lighting and floodlights. Dimmable. Indoor/outdoor.

**TYPE A - PLUG AND PLAY - T8 GLASS – MEDIUM BIPIN BASE** SOLD IN CASE QUANTITIES

MODEL NO.	SIZE	WATTS	EQUIV. WATTS	LUMENS	COLOR	RATED HOURS	QTY./CASE	PRICE PER BULB	
								1 CASE	3+ CASES
S-24772 S-24773	48"	9	32	1,600	Daylight (5000K) Cool (4100K)	50,000	25	\$10.25	\$9.50
S-23706 S-23707	48"	15	32	2,200	Daylight (5000K) Cool (4100K)	50,000	25	8.25	7.75

**TYPE A - PLUG AND PLAY - T8 PLASTIC – MEDIUM BIPIN BASE** SOLD IN CASE QUANTITIES

S-24774 S-24775	48"	10	32	1,600	Daylight (5000K) Cool (4100K)	50,000	25	\$11.50	\$10.75
S-23249 S-23250	48"	13	32	2,100	Daylight (5000K) Cool (4100K)	50,000	25	10.50	9.75

**TYPE B - BALLAST BYPASS - T8 GLASS – MEDIUM BIPIN BASE** SOLD IN CASE QUANTITIES

S-24776 S-24777	48"	12	32	1,800	Daylight (5000K) Cool (4100K)	50,000	25	\$10.75	\$10.00
S-24778 S-24779	48"	18	32	2,160	Daylight (5000K) Cool (4100K)	50,000	25	8.75	8.25
S-25501*	96"	36	75	4,400	Cool (4100K)	50,000	10	23.50	22.50

Rewiring required

\* Single Pin Base. Two-piece bulb.

**SCREW-IN – E26 MEDIUM BASE** SOLD IN CASE QUANTITIES

S-23587 S-21734	A19	8.5 14	60 100	800 1,500	Daylight (5000K) Warm (2700K)	11,000	6	\$2.25 6.50	\$2.00 6.00
S-24280	BR30	7.5	65	650	Warm (2700K)	15,000	12	7.25	6.75
S-24765	BR40	13	85	1,100	Warm (2700K)	25,000	6	10.00	9.50
S-24764*	BR40	15.5	120	1,400	Warm (2700K)	25,000	12	11.00	10.50
S-23589 S-21737	PAR38	16 15	120	1,300	Daylight (5000K) Warm (3000K)	15,000	6	18.25 18.50	17.25 17.50

\* Feit® brand

## LIGHT BULB STORAGE DRUMS



Don't toss those bulbs. Safely store old bulbs until you can recycle.

- Recommended for maintenance departments and schools.
- Large Capacity – Pack away up to 135 4' long fluorescent bulbs.
- All-fiber construction is lightweight, yet durable.
- Lid lifts off for easy loading.

FOR FLUORESCENT TUBES



Not a shipping container

SHIPS VIA MOTOR FREIGHT

MODEL NO.	DESCRIPTION	SIZE DIAM. x H	HOLDS	PRICE EACH	
				1	4+
S-24464	4' Medium	15½ x 48"	(38) T12 or (85) T8 Fluorescent Tubes	\$75	\$72
S-24465	4' Large	20 x 48"	(80) T12 or (135) T8 Fluorescent Tubes	90	86

# FLUORESCENT LIGHT BULBS

SYLVANIA®



## T8 FLUORESCENT – MEDIUM BIPIN BASE

SOLD IN CASE QUANTITIES

MODEL NO.	SIZE	WATTS	LUMENS	COLOR	RATED HOURS	QTY./CASE	PRICE PER BULB	
							1 CASE	3+ CASES
S-21220	24"	17	1,270	Cool (4100K)	30,000	30	\$4.95	\$4.80
S-19983	48"	32	2,725	Daylight (5000K)	40,000	30	5.25	5.05
S-11871			2,520	Cool (4100K)				
S-11872			2,520	Warm (3500K)				
■S-21221*	96"	59	5,425	Cool (4100K)	24,000	24	14.95	14.40

■ SHIPS VIA MOTOR FREIGHT

\* Single Pin Base

## T12 FLUORESCENT – MEDIUM BIPIN BASE

SOLD IN CASE QUANTITIES

S-21222	48"	40	1,720	Daylight (6500K)	22,500	30	\$4.75	\$4.60
S-19055			1,850	Cool (4100K)				
■S-21223*	96"	75	3,840	Daylight (6500K)	12,000	15	12.25	12.05
■S-19056*			3,875	Cool (4100K)				
■S-12675▲	96"	110	6,965	Cool (4200K)	12,000	15	12.95	12.75

■ SHIPS VIA MOTOR FREIGHT

\* Single Pin Base ▲ Recessed Base

## T5 ENERGY SAVERS – MINIATURE BIPIN BASE

SOLD IN CASE QUANTITIES

S-21224	45"	54	4,070	Daylight (5000K)	40,000	40	\$8.75	\$8.50
S-19984			4,140	Cool (4100K)				

## T8 U-BEND FLUORESCENT – MEDIUM BIPIN BASE

SOLD IN CASE QUANTITIES

S-21225	22"	32	2,625	Daylight (5000K)	20,000	16	\$14.95	\$14.35
S-19986			2,825	Cool (4100K)				

## METAL HALIDE LIGHT BULBS – E39 MOGUL BASE

SOLD IN CASE QUANTITIES

S-21228	ED28	175	12,800	Cool (4200K)	7,500	6	\$20.95	\$19.95
S-21229		250	20,000		10,000			
S-21230	ED37	400	32,000	Cool (4000K)	15,000		42.00	40.00
S-21703	BT56	1,000	86,000	12,000				

**Fluorescent Tubes** – The most popular bulbs used in offices today.

**T8** – High quality, bright lighting for schools, offices and hospitals. 1" diameter.

**T12** – Classic fluorescent tubes for your older warehouse fixtures. 1½" diameter.

**T5 Energy Savers** – High output tubes that last longer than T12. Ultra-slim 5/8" diameter. Compatible with T5 light fixtures only.

**U-Bend** – T8 lamp brightens hallways and restrooms. 6" bend spacing. Fits 2 x 2' fixtures.



## RECYCLING KITS

Recycling made easy. Pack it up and ship it out with one quick call to FedEx®.

- Automatically ships to the nearest Veolia recycling center.

MODEL NO.	KIT	INSIDE DIM. L x W x H	HOLDS	PRICE EACH	
				1	3+
S-14845	4' Medium	48 x 8 x 8"	(30) T12 or (72) T8 Fluorescent Tubes or (10) T12 or (20) T8 U-Shaped Tubes	\$87	\$85
S-14846	4' Large	48 x 12 x 12"	(68) T12 or (146) T8 Fluorescent Tubes or (22) T12 or (32) T8 U-Shaped Tubes	127	124
S-14847	8' Medium	96 x 6 x 6"	(16) T12 or (39) T8 Fluorescent Tubes	108	105
S-14848	5 Gallon Mixed Lamp Pail	12" Diam. x 13" H	Compact Fluorescent, Flood, Incandescent and HID Lamps	110	107

## PREPAID AND READY TO GO



## ECONOMY

**BEST SELLER**



Full keypad operates all functions quickly and easily.

- **Three separate displays** for total weight, unit weight and piece count. LB/KG convertible.
- Auto shut-off. • Automatic tare and zero tracking.
- Powered by rechargeable battery or AC adapter.

MODEL NO.	PLATFORM SIZE	CAPACITY/ ACCURACY	SHPG. LBS.	PRICE EACH	
				1	2+
H-1121	13 x 9½"	12 lbs. x .0005 lb.	15	\$430	\$400
H-1122		30 lbs. x .001 lb.			
H-1123		60 lbs. x .002 lb.			
H-1124	Replacement Battery			\$19	\$18

## EASY-COUNT SCALE



No frills counting scale.

- Simple one-touch weigh/count functions.
- LB/OZ/KG/G convertible.
- Powered by rechargeable battery or AC adapter.

MODEL NO.	PLATFORM SIZE	CAPACITY/ ACCURACY	SHPG. LBS.	PRICE EACH	
				1	2+
H-1653	11½ x 9"	3,000 g x .1 g	12	\$325	\$305
H-1654	11½ x 9"	6 lbs. x .0002 lb.	12	325	305
H-1649		12 lbs. x .0005 lb.			
H-1650		30 lbs. x .001 lb.			
H-1651		60 lbs. x .002 lb.			
H-1652	Replacement Battery			\$16	\$15

## INDUSTRIAL

**DURABLE**



Rugged and very durable – Made for the warehouse.

- Backlit LCD display. • Overload protection.
- LB/KG convertible.
- Stores up to 10 item weights.
- Powered by rechargeable battery or AC adapter.

MODEL NO.	PLATFORM SIZE	CAPACITY/ ACCURACY	SHPG. LBS.	PRICE EACH	
				1	2+
H-1114	11½ x 8½"	6 lbs. x .0005 lb.	11	\$558	\$507
H-1115		15 lbs. x .001 lb.			
H-1116		30 lbs. x .002 lb.			
H-1117		65 lbs. x .005 lb.			
H-1118		Replacement Battery			

## DELUXE

**HIGHEST PRECISION**



**EASY COUNT**



Highest precision. Jumbo 2" backlit LCD display.

- LB/OZ/KG/G convertible. • Stores weights for up to 255 items.
- Ultra-sensitive aluminum alloy load cell.
- High resolution – Up to 600,000 internal counts.
- Powered by rechargeable battery or AC adapter.

MODEL NO.	PLATFORM SIZE	CAPACITY/ ACCURACY	SHPG. LBS.	PRICE EACH	
				1	2+
H-5819	14½ x 9½"	11 lbs. x .0001 lb.	17	\$672	\$620
H-5820		27 lbs. x .0005 lb.			
H-5821		55 lbs. x .001 lb.			
H-5822		110 lbs. x .002 lb.			
H-1652		Replacement Battery			



# SCALES

## PLATFORM

## DIAL SCALE



These scales were designed with UPS and Parcel Post in mind.

- Withstands the roughest use.
- H-177: 8" dial.
- H-176: 10½" dial. Large numbers for easy, accurate reading.

**1 YEAR WARRANTY**

MODEL NO.	PLATFORM SIZE	CAPACITY/ ACCURACY	SHPG. LBS.	PRICE EACH	
				1	2+
H-177	10¼ x 10¼"	70 lbs. x 4 oz.	13	\$150	\$145
H-176	13 x 13"	100 lbs. x 4 oz.	27	230	220

## UTILITY

## UPS/PARCEL POST



- Memory Lock: Push down lever to lock in weight; can be read after object is removed.
- Heavy-duty 18 gauge steel case, nonslip platform.

**1 YEAR WARRANTY**

MODEL NO.	PLATFORM SIZE	CAPACITY/ ACCURACY	SHPG. LBS.	PRICE EACH	
				1	2+
H-103	13 x 10¼"	100 lbs. x 1 lb.	10	\$76	\$71
H-104		250 lbs. x 1 lb.		80	75

## OHAUS

## DIGITAL SCALE



DEFENDER®  
5000

NTEP  
CERTIFIED

LARGE PLATFORM

Withstands constant industrial use. Highly accurate.

- Extra large, stainless steel platform.
- LB/OZ/LB:OZ/KG/G convertible.
- Bright, backlit LCD display.
- Powered by battery pack\* or 6 ft. cord (included).

\* BATTERY PACK NOT INCLUDED. SEE ULINE.COM

**1 YEAR WARRANTY**

MODEL NO.	PLATFORM SIZE	PLATFORM STYLE	CAPACITY/ ACCURACY	SHPG. LBS.	PRICE EACH	
					1	2+
H-8105	18 x 18"	Stainless Steel	100 lbs. x .005 lb.	33	\$1,870	\$1,845
H-8106			250 lbs. x .01 lb.			
H-8107	24 x 24"		500 lbs. x .02 lb.	82	2,085	2,060

■ SHIPS VIA MOTOR FREIGHT

## RUBBERMAID®

## DIGITAL SCALE



Nonslip steel platform has low-profile design.

- Detachable table or wall mount indicator has 9 ft. cord.
- Tare indicator.
- LB/KG convertible.
- Powered by 9V battery\* or included AC adapter.

\* BATTERY NOT INCLUDED. SEE PAGE 636

**1 YEAR WARRANTY**

MODEL NO.	PLATFORM SIZE	CAPACITY/ ACCURACY	SHPG. LBS.	PRICE EACH	
				1	2+
H-480	12 x 12½"	150 lbs. x .2 lb.	10	\$150 any qty.	
H-479		400 lbs. x .5 lb.		\$169	\$163

# PARCEL SCALE



NTEP CERTIFIED

Compatible with shipping systems from UPS, FedEx® and other parcel carriers.

- LB/KG convertible. Bright, easy-to-read 1⅝" LCD display.
- GeoCal™ automatically calibrates scale right out of the box.
- USB or RS232 connections for plug-and-play operation.
- Large stainless steel platform.
- AC adapter included.

Roller Ball Top, see uline.com

MODEL NO.	PLATFORM SIZE	CAPACITY/ ACCURACY	SHPG. LBS.	PRICE EACH	
				1	2+
H-5275	12 x 14"	150 lbs. x .05 lb.	17	\$895	\$870

# ULINE PLATFORM SCALES



**INDUSTRIAL**

Large, industrial size platform.

- 150 lb. capacity.
- 330 lb. capacity.



**DELUXE**

The largest platform scale we sell.

- 660 lb. capacity.
- 1,320 lb. capacity.

**1 YEAR WARRANTY**

- Operates on rechargeable batteries or AC adapter (included).
- LB/KG convertible.
- Auto zero tracking.
- Stainless steel platform.
- Overload indicator.
- Removable 26" tower included.
- Calculates sample weight.
- Counts up to 999,999 pieces.

- Operates on rechargeable batteries or AC adapter (included).
- LB/KG convertible.
- Auto zero tracking.
- Stainless steel platform.
- Recalls last weight.
- Removable 26" tower included.
- Calculates sample weight.
- Counts up to 999,999 pieces.

MODEL NO.	PLATFORM SIZE	CAPACITY/ ACCURACY	SHPG. LBS.	PRICE EACH	
				1	2+
H-4593	14½ x 20"	150 lbs. x .01 lb.	38	\$635	\$610
H-670		330 lbs. x .1 lb.			

MODEL NO.	PLATFORM SIZE	CAPACITY/ ACCURACY	SHPG. LBS.	PRICE EACH	
				1	2+
H-747	18 x 23"	660 lbs. x .1 lb.	52	\$795	\$770
H-794		1,320 lbs. x .2 lb.		880	850

## PLATFORM SCALES



**WASHDOWN**



Water resistant. Full stainless steel construction.

**1 YEAR WARRANTY**

- Wipe away food residue and contaminants.
- Sealed indicator.
- Internal battery and AC adapter included.
- LB/OZ/KG convertible.
- Auto zero tracking.
- Removable 26" tower mount.
- Calculates sample weight.

MODEL NO.	PLATFORM SIZE	CAPACITY/ ACCURACY	SHPG. LBS.	NTEP Certified PRICE EACH	
				1	2+
H-5836	16 x 20"	100 lbs. x .02 lb.	46	\$1,135	\$1,080
H-5837		200 lbs. x .05 lb.			

## OHAUS PLATFORM SCALES



**INDUSTRIAL**



**DEFENDER® 3000**

Very dependable scale. Large, multicolor LCD display.

- Display color changes when weight is low, high or in-range.
- LB/KG convertible.
- Overload indicator.
- Removable 27" tower mount.
- Stainless steel platform.
- Runs up to 360 hours on 6 C batteries\*. AC adapter included.

MODEL NO.	PLATFORM SIZE	CAPACITY/ ACCURACY	SHPG. LBS.	NTEP Certified PRICE EACH	
				1	2+
H-10772	16 x 21"	150 lbs. x .02 lb.	46	\$1,200	\$1,150
H-10773		300 lbs. x .05 lb.			

\* Batteries not included, see page 636

NTEP Certified



## CALIBRATION WEIGHTS

Accurately calibrate trip balances, industrial and platform scales.

- Weights meet ASTM Classes 5, 6 or 7.
- Grams, kilograms and NIST traceable weights also available. See [uline.com](http://uline.com)

MODEL NO.	DESCRIPTION	WEIGHT/ SIZE	CLASS	PRICE EACH
S-15287	Stainless Steel	1 lb.	5	\$62
S-15289		5 lbs.		140
S-15290	Cast Iron	10 lbs.	7	84
S-15291		20 lbs.	6	108
S-22450	Cast Iron	25 lbs.	6	142
S-22451		50 lbs.		162

# LOW PROFILE FLOOR SCALES

Weigh loaded pallets on heavy-duty steel scale. Place pallets on scale or drive on with optional ramp.

- LED display with 15' cable and mounting bracket included.
- LB/KG convertible. • Full capacity tare.
- Auto zero tracking. • Factory pre-calibrated.
- Ramps offer easy access for dollies, carts and hand trucks. Each ramp sold individually.



## STANDARD

## 1 YEAR WARRANTY

MODEL NO.	DIMENSIONS	CAPACITY/ ACCURACY	SHPG. LBS.	PRICE EACH
H-3001 H-3002	3' x 3' x 4"	5,000 lbs. x 1 lb. 10,000 lbs. x 2 lbs.	155	\$1,350
H-3003	3' x 3' Ramp	10,000 lbs.	82	540
H-754 H-756	4' x 4' x 4"	5,000 lbs. x 1 lb. 10,000 lbs. x 2 lbs.	225	1,650
H-758	4' x 4' Ramp	10,000 lbs.	166	610
H-3004 H-3005	4' x 6' x 4"	5,000 lbs. x 1 lb. 10,000 lbs. x 2 lbs.	345	1,870
H-758	4' x 4' Ramp	10,000 lbs.	166	610
H-1607 H-1608	5' x 5' x 4"	5,000 lbs. x 1 lb. 10,000 lbs. x 2 lbs.	340	1,870
H-1609	5' x 4' Ramp	10,000 lbs.	204	750

Additional sizes, see [uline.com](#)

DROP SHIPS IN 2 TO 3 DAYS FROM IN

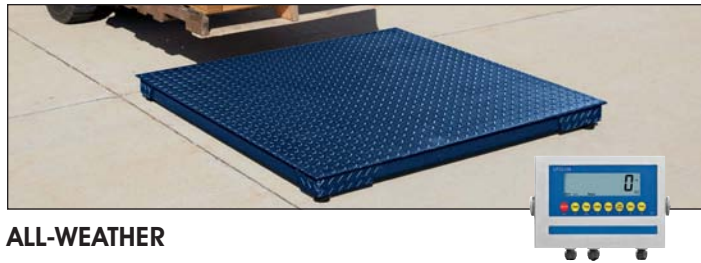

## ALL-WEATHER

Stands up to Texas-sized downpours. For recycling, landscaping and outdoor receiving areas.

- Water-resistant, stainless steel indicator with LCD display, load cells and internal components included.

## 1 YEAR WARRANTY

MODEL NO.	DIMENSIONS	CAPACITY/ ACCURACY	SHPG. LBS.	PRICE EACH
H-7935 H-7936	4' x 4' x 4"	5,000 lbs. x 1 lb. 10,000 lbs. x 2 lbs.	231	\$2,520
H-758	4' x 4' Ramp	10,000 lbs.	166	610

DROP SHIPS IN 2 TO 3 DAYS FROM IN



LED Display – Big, easy-to-read 3/4" numbers.



H-3003, H-758 AND H-1609 RAMP

## PRINTER/PAPER

Quickly prints weights from standard, all-weather and stainless steel floor scales.

- Includes printer, AC adapter, interface cable and 1 paper roll.



Label printer available, see [uline.com](#)

MODEL NO.	MAX. PRINT W x L	COMPATIBILITY	PRINT SPEED	PRICE EACH	
				1	2+
H-4601	2 x 4"	RS-232	1.2"/sec.	\$300	\$290
S-16160	Thermal Paper	2 1/4" x 85'	50 rolls/ctn.	\$39/ctn.	3+ \$38/ctn.



## STAINLESS STEEL

Weigh food, chemicals or pharmaceuticals. Withstands the harshest environments.

- Stainless steel indicator with LED display, feet and hardware with food-grade welds included.

## 1 YEAR WARRANTY

MODEL NO.	DIMENSIONS	CAPACITY/ ACCURACY	SHPG. LBS.	PRICE EACH
H-4602 H-4603	4' x 4' x 4"	5,000 lbs. x 1 lb. 10,000 lbs. x 2 lbs.	231	\$3,950
H-4604	4' x 4' Ramp	10,000 lbs.	134	1,650

DROP SHIPS IN 2 TO 3 DAYS FROM IN

# ULINE PALLET TRUCK SCALES

Basic, easy-to-use truck weighs and moves pallets with ease.

- Fork height: 3 1/3" lowered, 7 1/2" raised. 220° steering arc.
- Rechargeable battery included – Operates up to 60 hours.

H-4564 – Built-in thermal printer for on-the-spot shipping weights.

## LIMITED 1 YEAR WARRANTY

MODEL NO.	DESCRIPTION	FORK SIZE L x W	CAPACITY/ ACCURACY	SHPG. LBS.	PRICE EACH
H-1679 H-2331	Standard Narrow	48 x 27" 46 x 21"	5,000 lbs. x 1 lb.	375 353	\$1,925
H-4564	Standard w/ Printer	48 x 27"		380	
S-16160	Thermal Paper	2 1/4" x 85'	50 rolls/ctn.	\$39/ctn. 3+ \$38/ctn.	

SHIPS UNASSEMBLED VIA MOTOR FREIGHT



Large, easy-to-read 2" LCD display.





# ULINE BALANCE SCALES

PRECISION



Accurate measurements for everyday use. For pharmaceutical and manufacturing labs.

- Three application modes: weighing, parts counting and check weighing.
- G/OZ/OZT/DWT/N/CT/GRN convertible.
- Large, easy-to-read backlit LCD display.
- Runs up to 270 hours on 4 C batteries. AC adapter included.

**1 YEAR WARRANTY**

MODEL NO.	PLATFORM SIZE	CAPACITY/ ACCURACY	SHPG. LBS.	PRICE EACH	
				1	2+
H-9884	5.7" Round	220 g x 0.01 g	3	\$220	\$210

MODEL NO.	PLATFORM SIZE	CAPACITY/ ACCURACY	SHPG. LBS.	PRICE EACH	
				1	2+
H-9885	7.5 x 5.7"	2,200 g x 0.01 g	3	\$320	\$300
H-9886*		2,200 g x 0.1 g		240	230

\*Also kg, lb and lb:oz convertible

# ULINE DIGITAL FOOD SCALES

PORTIONING



STANDARD



DELUXE

A must have in any kitchen or restaurant. For precise ingredient measurements.

- Tare and auto shutoff features.
- Sealed buttons and display for easy wipe-down.
- OZ/LB:OZ/G convertible.
- Portable. Powered by included batteries.

Deluxe – Stainless steel platform and large backlit display. Also fl. oz. and mL convertible for liquid ingredients.

**1 YEAR WARRANTY**

MODEL NO.	DESCRIPTION	PLATFORM SIZE	CAPACITY/ ACCURACY	SHPG. LBS.	PRICE EACH	
					1	2+
H-9983	Standard	5.5" Round	11 lbs. x 0.1 oz.	1	\$32	\$30
H-9984	Deluxe	5.5 x 5.5"	15 lbs. x 0.05 oz.	2	42	40

# OHAUS RANGER® COUNT 3000 SCALES

NTEP CERTIFIED

Never be wrong. Meets all legal requirements.

- Five application modes, including weighing, parts counting, check counting and accumulation.
- Backlit LCD displays.
- Overload protection.
- LB/OZ/LB:OZ/KG/G convertible.
- 210-hour battery life.
- Stores up to 30 item weights.
- Integrated carrying handle.

MODEL NO.	PLATFORM SIZE	CAPACITY/ ACCURACY	SHPG. LBS.	PRICE EACH	
				1	2+
H-9554	11.8 x 8.9"	30 lbs. x .001 lb.	12	\$895	\$870
H-9555		60 lbs. x .002 lb.			
H-9556	Replacement Battery			102	97

- Powered by rechargeable battery or included AC adapter.



**1 YEAR WARRANTY**

# OHAUS RANGER® 7000 DIGITAL SCALES

NTEP CERTIFIED

The Holy Grail of scales. Replaces your lab, counting and industrial instruments.

- 10 application modes, including parts counting, check weighing and dynamic weighing for unstable loads.
- Excellent accuracy for weighing fine powders and small precision parts.

MODEL NO.	PLATFORM SIZE	CAPACITY/ ACCURACY	SHPG. LBS.	PRICE EACH	
				1	2+
H-7991	11 x 11"	6 lbs. x .0001 lb.	19	\$1,965	\$1,915
H-7992		15 lbs. x .0002 lb.			
H-7993	14.8 x 12.3"	30 lbs. x .0005 lb.	30	1,965	1,915
H-7994		70 lbs. x .001 lb.			
H-7995		150 lbs. x .002 lb.			

- Rugged, cast metal housing with sealed indicator.
- LB/OZ/LB:OZ/KG/G convertible.
- Includes 10' power cord.



**1 YEAR WARRANTY**

Compact and dependable. Widely used in schools and manufacturing facilities.

- Six application modes, including parts counting, percent weighing, totalizing and display hold.
- G/OZ/OZT/DWT/N/CT/GRN convertible.
- Large, easy-to-read LCD display.
- Calculates sample weight. • Simple four-button operation.
- Powered by 4 AA batteries or included AC adapter.



1 YEAR WARRANTY

MODEL NO.	PLATFORM SIZE	CAPACITY/ ACCURACY	SHPG. LBS.	PRICE EACH	
				1	2+
H-5848	4.7" Round	220 g x 0.01 g	4	\$465	\$450
H-5849		420 g x 0.01 g		655	630
H-5850*		620 g x 0.01 g		770	740
H-5851	4.7" Round	420 g x 0.1 g		260	250

\*Also lb and lb:oz convertible

MODEL NO.	PLATFORM SIZE	CAPACITY/ ACCURACY	SHPG. LBS.	PRICE EACH	
				1	2+
H-5852*	6.7 x 5.5"	620 g x 0.1 g	4	\$355	\$345
H-5853**		2,200 g x 0.1 g		450	435
H-5854**		6,200 g x 0.1 g		795	765
H-5855**	6.7 x 5.5"	8,200 g x 1 g		400	390

\*\*Also kg, lb and lb:oz convertible

Versatile and accurate. Recommended for research and quality control labs.

- Nine application modes, including density determination, dynamic weighing, percent weighing, formulation and totalization.
- G/KG/OZ/LB/OZT/DWT convertible.
- Color touch screen operates with or without lab gloves on.
- Convenient front USB port. • Powered by AC adapter.

H-5276 – Includes draftshield with removable glass doors.



H-5276



H-6097

1 YEAR WARRANTY

MODEL NO.	PLATFORM SIZE	CAPACITY/ ACCURACY	SHPG. LBS.	PRICE EACH	
				1	2+
H-5276*	5.1" Round	420 g x 0.001 g	19	\$1,975	\$1,940
H-6097	7.7 x 7"	820 g x 0.01 g	15	1,330	1,300

\*Also mg convertible

MODEL NO.	PLATFORM SIZE	CAPACITY/ ACCURACY	SHPG. LBS.	PRICE EACH	
				1	2+
H-5278	7.7 x 7"	1,520 g x 0.01 g	15	\$1,640	\$1,610
H-5279		8,200 g x 0.1 g	13	1,600	1,570

Slim, lightweight and easy to use. Ideal for postal weighing and light production.

- G/OZ/N convertible. • Large, backlit LCD display. • Simple two-button operation.

MODEL NO.	PLATFORM SIZE	CAPACITY/ ACCURACY	SHPG. LBS.	PRICE EACH	
				1	2+
H-8109	5 x 5.5"	220 g x 0.1 g	2	\$145	\$140
H-8110*		2,200 g x 1 g		145	140
H-8111*		5,200 g x 1 g		170	165

AC adapter available, see uline.com

\*Also lb:oz convertible

- Auto shut-off and battery indicator.
- Runs up to 1,000 hours on 3 AA batteries.



H-8109

Waterproof stainless steel construction for use in kitchens, delis and bakeries.

- Four application modes: simple weighing, percent weighing, combined zero/tare and specific gravity.

MODEL NO.	PLATFORM SIZE	CAPACITY/ ACCURACY	SHPG. LBS.	PRICE EACH	
				1	2+
H-4597	6 x 6"	3,000 g x 0.5 g	6	\$570	\$550
H-4598		6,000 g x 1 g			

USDA-AMS Accepted/NTEP Certified

- 10 times capacity overload protection.
- G/KG/OZ/LB/LB:OZ convertible.
- Runs up to 120 hours on 4 C batteries. AC adapter included.



NSF CERTIFIED

# SWINGLINE® MANUAL STAPLERS

DESKTOP



H-2029



H-2323

An office necessity. Enjoy Swingline® quality and performance.

**H-2029** – America's #1 desktop stapler. Die-cast all-metal construction. Staples up to 30 sheets.

**H-2323** – Heavy duty. Requires 50% less effort than standard staplers. Staples up to 120 sheets.

SWINGLINE® 747		STAPLES		CARTON OF 5,000			
MODEL NO.	SHEET CAPACITY	PRICE EACH		MODEL NO.	SIZE	PRICE EACH	
		1	3+			3	6+
H-2029	30	\$23	\$22	S-14138	1/4"	\$3.00	\$2.85

SWINGLINE® HEAVY DUTY		STAPLES		CARTON OF 2,500			
MODEL NO.	SHEET CAPACITY	PRICE EACH		MODEL NO.	SIZE	PRICE EACH	
		1	3+			3	6+
H-2323	120	\$95	\$90	S-14967	5/8"	\$8.25	\$7.75

**FREE OFFER:**  
Order \$50 of Desktop Staples, get a **FREE** Magnetic Staple Remover.



S-14924	\$3.75
---------	--------

# DESKTOP HOLE PUNCH



## HIGH CAPACITY

Easily punches up to 20 sheets with 50% less effort.

- Adjustable for 2 or 3-hole punching.
- Base slides open for easy chip disposal.

SWINGLINE®		SHEET CAPACITY	PRICE EACH	
MODEL NO.	DESCRIPTION		1	3+
H-5272	Desktop	20	\$47	\$45

# HAMMER TACKERS

BOSTITCH



## INDUSTRIAL

Staple packing lists to boxes when picking and packing orders.

- Designed for quick, repetitive stapling.
- Tough, compact and easy to use.

BOSTITCH INDUSTRIAL		STAPLES		CARTON OF 5,000			
MODEL NO.	STAPLE CAPACITY	PRICE EACH		MODEL NO.	SIZE	PRICE EACH	
		1	3+			3	6+
H-341	84	\$48	\$45	S-1562	1/4"	\$17	\$15



## HEAVY DUTY

Fast installation of poly sheeting, insulation and roofing paper.

- Tack paperwork on wooden crates.
- Comfortable rubber handle absorbs shock.
- Jam proof.

BOSTITCH HEAVY DUTY		STAPLES		CARTON OF 5,880			
MODEL NO.	STAPLE CAPACITY	PRICE EACH		MODEL NO.	SIZE	PRICE EACH	
		1	3+			1	3+
H-2018	84	\$51	\$48	S-1481	3/8"	\$27	\$25

# ELECTRIC STAPLER

BOSTITCH



## B8®

Speedy, reliable workhorse.

- No-Jam™ mechanism.
- Quick operation.
- Rubber feet for sure grip.

BOSTITCH B8®		STAPLES		CARTON OF 5,000			
MODEL NO.	SHEET CAPACITY	PRICE EACH		MODEL NO.	SIZE	PRICE EACH	
		1	3+			3	6+
H-2028	45	\$82	\$77	S-17849	1/4"	\$4.35	\$4.10
				S-14137	3/8"	7.00	6.65

# MAGAZINE FILE BOX



Organize and display magazines and catalogs on shelves and desks.

- Assembles in seconds. No glue or tape needed.
- 200 lb. test corrugated.
- Large 4 x 3" labeling area.

Storage File Boxes, pages 70-71, 73

		SOLD IN BUNDLE QUANTITIES		
MODEL NO.	SIZE L x W x H	QTY./ BUNDLE	PRICE EACH	
			25	50+
S-8244	9 1/4 x 4 x 12"	25	\$2.40	\$2.30



# PLIER STAPLERS

MORE STAPLERS AVAILABLE, see [uline.com](http://uline.com)



**BOSTITCH**

## INDUSTRIAL

Handheld stapler seals padded bags, bubble bags and foam pouches.

- More powerful, easy to squeeze.
- Quick, easy staple loading.
- Durable steel construction.
- H-309 Saber Point facilitates stapling cartons.



H-309 SABER POINT

MODEL NO.	DESCRIPTION	QTY./CTN.	PRICE EACH		
			1	3	6+
H-308	Industrial Stapler	N/A	\$40	\$38	\$36
H-309	Industrial Saber Point Stapler	N/A	54	52	50
S-1480	Deluxe 1/4" Staples	5,040	25	23	21
S-1481	Deluxe 3/8" Staples	5,880	27	25	23



## ECONOMY

A handheld stapler for office use.

- Staple invoices, paperwork and lightweight packaging.
- Anti-jamming. Steel construction.

MODEL NO.	DESCRIPTION	QTY./CTN.	PRICE EACH		
			1	3	6+
H-704	Stapler	N/A	\$25	\$23	\$21
S-5519	1/4" Staples	5,000	6.75	6.00	4.20
S-5520	5/16" Staples	5,000	7.25	6.50	5.25

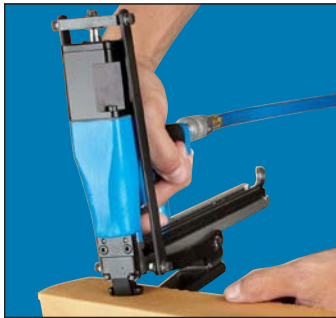

Kihlberg H-3069

## PNEUMATIC

Quickly assemble corrugated trays, lids and cartons.

- **ULINE** – Best value. Everyday workhorse. Fast and easy to load. 6" throat depth.
- **Kihlberg** – No recoil. Powerful, quiet operation. Ergonomic handle. Sleek design. 5 1/2" throat depth.
- Accepts 3/8", 1/2" and 5/8" staples.
- Use with air compressor.



**ULINE** H-3068

### STAPLERS

### REQUIRED STAPLES

MODEL NO.	DESCRIPTION	BOX	STAPLE CAPACITY	WT. (LBS.)	PRICE EACH		MODEL NO.	DESCRIPTION	BOX	QTY./CTN.	WT. (LBS.)	PRICE PER CARTON		
					1	2+						1	5	20+
H-3068	Uline Kihlberg 777L	SW	102	5	\$465	\$435	S-17851	Uline 5/8" Stick	SW	2,400	3	\$12.00	\$11.50	\$11.00
H-3069	Kihlberg 777L	SW	100		795	755	S-17850	JK 777-16 - 5/8" Stick	SW			19.50	19.00	18.50

## ULINE STAPLE REMOVER



Removes all carton staples.

### FREE OFFER:

Order \$200 or more of staples and receive a **FREE** staple remover.

MODEL NO.	DESCRIPTION	WT. (LBS.)	PRICE EACH
H-289	Staple Remover	.20	\$11

## STAPLE GUNS

### MANUAL

All purpose. Every warehouse, office and home needs one.

- Easy-squeeze trigger.
- Jam free.

### HEAVY DUTY MANUAL

For carpet padding, plastic sheeting and upholstery.

- Double-wall nose plate for extra durability.
- Ergonomic comfortable grip.
- Jam free.



MANUAL

MODEL NO.	DESCRIPTION	RECOMMENDED USE	CAPACITY QTY./CTN.	PRICE EACH		
				1	3	6+
H-2019	Manual Staple Gun	N/A	84 staples	\$35	\$33	\$32
S-14135	T50 1/4" Staples	Insulation	5,000	14	13	11
S-17852	T50 3/8" Staples	Upholstery		18	17	15
S-17853	T50 1/2" Staples	Roofing Felt		19	18	16
H-2020	Heavy Duty Staple Gun	N/A	84 staples	37	35	34
S-1481	Deluxe 3/8" Staples	Flooring	5,880	27	25	23



HEAVY DUTY

# CARTON STAPLES

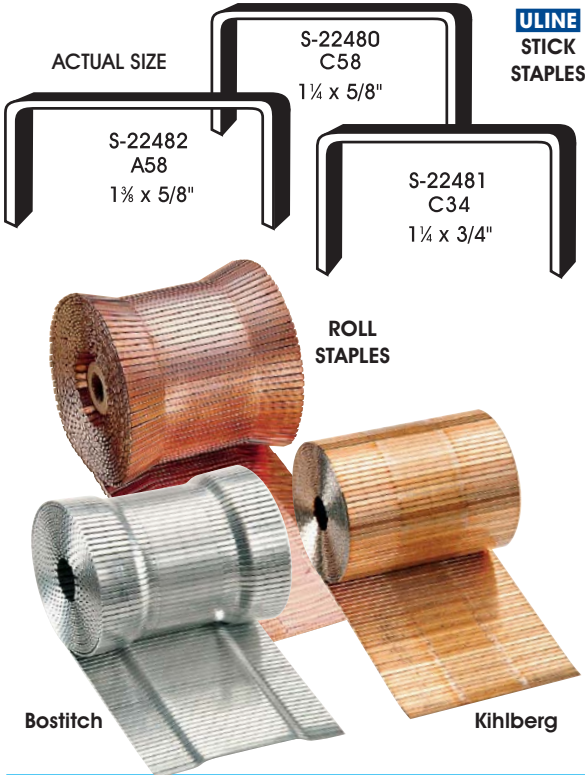

**ULINE**  
STICK  
STAPLES

Uline stocks a complete inventory of carton staples.

- "C", "A" and "RR1" staples compatible with International Staple, Duofast, Salco, Beck and BEA.
- Bostitch and Kihlberg: roll staples are only compatible with their own brand staplers.

MODEL NO.	DESCRIPTION	CROWN WIDTH	LEG LENGTH	STAPLES PER STICK/ROLL	STAPLES/ CTN.	WT. (LBS.)	PRICE/CARTON		
							1	2	4+

## ULINE STICK STAPLES

S-22480	C58				25,000	40	\$113 any ctn. qty.		
S-22481	C34	1 1/4"	3/4"	50	20,000	36	\$111 any ctn. qty.		
S-22482	A58	1 1/2"	5/8"	50	20,000	42	\$119	\$116	\$114

## ULINE ROLL STAPLES

S-860	RR1-58				24,000	40	\$126	\$121	\$116
S-861	RR1-34	1 1/4"	3/4"	1,000	24,000	45	137	132	127

## KIHLBERG STICK STAPLES

S-10720	JK561 - C58				25,000	40	\$130	\$125	\$120
S-10721	JK561 - C34	1 1/4"	3/4"			44	135	130	125

## KIHLBERG ROLL STAPLES

USE ONLY WITH KIHLBERG STAPLERS

S-8258	JK555 - 5/8				20,000	36	\$170	\$163	\$155
S-8259	JK555 - 3/4	1 1/4"	3/4"	1,000	20,000	40	195	185	175

## BOSTITCH ROLL STAPLES

USE ONLY WITH BOSTITCH STAPLERS

S-2724	SWC7437-58				24,000	41	\$273	\$264	\$254
S-2725	SWC7437-34	1 1/2"	3/4"	1,000	24,000	47	285	275	265

# BOTTOM STAPLERS



## ULINE MANUAL

Save time by pre-closing the bottoms of your cartons.

- Makes up to **50** cartons per hour.
- 50" overall height.
- Uses 5/8" or 3/4" staples.

## FOOT OPERATED

## KIHLBERG PNEUMATIC

Effortless operation for high volume use.

- Staple cartons twice as fast. Seal up to **100** cartons/hour.
- Use with air compressor. Min. 80 lbs. per square inch.
- 53" overall height.
- Uses 5/8" or 3/4" staples.

## STAPLERS

MODEL NO.	DESCRIPTION	BOX	STAPLE CAPACITY	WT. (LBS.)	PRICE EACH	
					1	2+
H-1980	Uline Manual	275 lb.	200	79	\$725	\$695
H-3070	Kihlberg Pneumatic	275 lb.	300	93	1,450	1,400

## REQUIRED STAPLES

MODEL NO.	DESCRIPTION	BOX	STAPLES/ CTN.	WT. (LBS.)	PRICE/CARTON	
					1	2+
S-22480	C58 Stick Staples	SW	25,000	40	\$113 any ctn. qty.	
S-22481	C34 Stick Staples	DW	20,000	36	\$111 any ctn. qty.	
S-10720	JK561 - C58 Stick	SW	25,000	40	\$130	\$125
S-10721	JK561 - C34 Stick	DW		44	135	130



# NAIL GUN

## PNEUMATIC

Quickly construct pallets and crates.

- Easy load, large-capacity magazine.
- Angled coil design.
- Use with air compressor. Min. 70 lbs. per square inch.

Nails – Coated steel. Screw shank for strongest hold.



MODEL NO.	DESCRIPTION	CAPACITY	QTY./ CTN.	WT. (LBS.)	PRICE EACH	
					1	2+
H-8726	Bostitch N70CB Nail Gun	300	N/A	8	\$440	\$430
S-23693	2" Screw Shank Nails – 250 Nails/Coil		9,000	43	145	140

# CARTON STAPLERS

## MANUAL STICK

**1 YEAR WARRANTY**

Lightweight to reduce fatigue.

- **ULINE "C"** – Easily adjusts to 5/8" or 3/4" staples.
- **ULINE "A"** – 1 3/8" crown width for heavy duty carton sealing.
- **Kihlberg** – Use all day long without fatigue. Highly recommended.
- 5 easy adjustable depth positions.
- 3/4" staplers recommended for Double Wall Cartons (DW).



### STAPLERS

MODEL NO.	DESCRIPTION	BOX	STAPLE CAPACITY	WT. (LBS.)	PRICE EACH	
					1	2+
H-1025	Uline Stapler "C" 5/8"	SW	100	5	\$166	\$146
H-1026	Uline Stapler "C" 3/4"	DW				
H-1024	Uline Stapler "A" 5/8"	SW				
H-1993	Kihlberg Stick "C" 5/8" & 3/4"	SW DW	150	4	320	305

### REQUIRED STAPLES

MODEL NO.	DESCRIPTION	QTY./ CTN.	WT. (LBS.)	PRICE PER CARTON		
				1	2	4+
S-22480	Uline C58 Stick	25,000	40	\$113 any ctn. quantity		
S-22481	Uline C34 Stick	20,000	36	\$111 any ctn. quantity		
S-22482	Uline A58 Stick	20,000	42	\$119	\$116	\$114
S-10720	JK561 - C58 Stick	25,000	40	130	125	120
S-10721	JK561 - C34 Stick	25,000	44	135	130	125

## PNEUMATIC STICK

Use one hand for fast, easy operation. Moderate use. Seal 50 - 200 cartons per day.

- **ULINE** – Lightweight to reduce fatigue. Uses both 5/8" and 3/4" staples.
- **Kihlberg** – Fast, efficient and quiet. Swedish quality. Easy 5-setting adjustment.
- Use with air compressor. Minimum 80 lbs. per sq. inch.



### STAPLERS

MODEL NO.	DESCRIPTION	BOX	STAPLE CAPACITY	WT. (LBS.)	PRICE EACH	
					1	2+
H-1027	Uline Stapler "C" 5/8"	SW	100	5	\$318	\$298
H-1028	Uline Stapler "C" 3/4"	DW				
H-3064	Uline Stapler "A" 5/8"	SW				
H-1440	Kihlberg Stick "C" 5/8" & 3/4"	SW DW	150	4	530	510

### REQUIRED STAPLES

MODEL NO.	DESCRIPTION	QTY./ CTN.	WT. (LBS.)	PRICE PER CARTON		
				1	2	4+
S-22480	Uline C58 Stick	25,000	40	\$113 any ctn. quantity		
S-22481	Uline C34 Stick	20,000	36	\$111 any ctn. quantity		
S-22482	Uline A58 Stick	20,000	42	\$119	\$116	\$114
S-10720	JK561 - C58 Stick	25,000	40	130	125	120
S-10721	JK561 - C34 Stick	25,000	44	135	130	125

## PNEUMATIC ROLL FEED

Fast and efficient – Maximum speed, less downtime. Seals over 250 cartons per day.

- **ULINE** – Adjusts to use 5/8" and 3/4" staples. Uses RR1 staples only.
- **Kihlberg** – Quiet and easy operation. Uses JK555 staples only.
- Use with air compressor. Min. 80 lbs. per sq. inch.



### STAPLERS

MODEL NO.	DESCRIPTION	BOX	STAPLE CAPACITY	WT. (LBS.)	PRICE EACH	
					1	2+
H-1030	Uline Stapler 5/8"	SW	1,000	6	\$356	\$346
H-1031	Uline Stapler 3/4"	DW				
H-1335	Kihlberg 5/8" & 3/4"	SW DW	1,000	4	640	630

### REQUIRED STAPLES

MODEL NO.	DESCRIPTION	QTY./ CTN.	WT. (LBS.)	PRICE PER CARTON		
				1	2	4+
S-860	RR1-58 Roll	24,000	40	\$126	\$121	\$116
S-861	RR1-34 Roll			137	132	127
S-8258	JK555 - 5/8 Roll	20,000	36	170	163	155
S-8259	JK555 - 3/4 Roll			195	185	175



# MICROFLEX® GLOVES

EXAM GRADE



## LATEX SAFEGRIP™

Incredible 12 mil glove protects hands in high-risk environments.

- Extended beaded cuff protects wrist and forearm.
- Textured fingers for superior grip.

FDA COMPLIANT

MODEL NO.	DESCRIPTION	MIL	SIZE	GLOVES/CARTON	PRICE PER CARTON	
					2	10+
S-13450	Powder-Free	12	S, M, L, XL	50	\$30	\$28



## LATEX DIAMOND GRIP®

Police rely on this puncture-resistant glove. Auto detail guys like it too.

- Textured Fingertips – Pick up small parts with ease.
- Contoured fit for all-day wear.

FDA COMPLIANT

MODEL NO.	DESCRIPTION	MIL	SIZE	GLOVES/CARTON	PRICE PER CARTON	
					2	10+
S-11886	Powder-Free	7	XS, S, M, L, XL	100	\$26	\$24



## LATEX ULTRA ONE®

EMTs and emergency responders depend on this glove.

- Strong and durable 10 mil thick protection with superior fingertip sensitivity.
- Extended beaded cuff increases strength and safety.

FDA COMPLIANT

MODEL NO.	DESCRIPTION	MIL	SIZE	GLOVES/CARTON	PRICE PER CARTON	
					2	10+
S-18043	Powder-Free	10	S, M, L, XL	50	\$24	\$22



## NITRILE SUPRENO® SE

Superior strength and protection for wet or dry applications.

- Interior polymer coating for easy on/off.
- Textured fingers for added grip.

FDA COMPLIANT

MODEL NO.	DESCRIPTION	MIL	SIZE	GLOVES/CARTON	PRICE PER CARTON	
					2	10+
S-15363	Powder-Free	6	S, M, L, XL	100	\$23	\$21

# ANSELL TOUCH N TUFF®



## EXAM GRADE LATEX 69-318

Superb comfort and dexterity for handling delicate products.

- Textured 5 mil for ultimate protection.
- Used in food processing, labs and pharmacies.

FDA COMPLIANT

MODEL NO.	DESCRIPTION	MIL	SIZE	GLOVES/CARTON	PRICE PER CARTON	
					2	10+
S-15322	Powder-Free	5	S, M, L, XL	100	\$24	\$22

# ULINE SAFE-FLEX



## EXAM GRADE NITRILE

Perfect blend of comfort and protection for lab techs and first responders.

- Tested for use with chemotherapy drugs. Meets ASTM D6978.
- Textured fingertips.
- Puncture resistant.

FDA COMPLIANT

MODEL NO.	DESCRIPTION	MIL	SIZE	GLOVES/CARTON	PRICE PER CARTON	
					2	10+
S-21573	Powder-Free	6	S, M, L, XL	100	\$19	\$17

# ULINE LATEX GLOVES

## INDUSTRIAL

All-purpose gloves for general industrial use.

- Beaded cuff for added strength.
- Offers comfort fit. • Superior dexterity.

FDA COMPLIANT

\* 90/CARTON

MODEL NO.	DESCRIPTION	MIL	SIZE	GLOVES/CARTON	PRICE PER CARTON	
					2	10+
S-5491	Powdered	5	XS, S, M, L, XL*	100	\$13	\$11
S-6606	Powder-Free				14	12
S-11428	Powder-Free	7	S, M, L, XL	100	19	17



## INDUSTRIAL IN A BUCKET

Portable, economical and convenient.

- All-purpose latex gloves for general industrial use.
- Beaded cuff for added strength. Comfort fit with superior dexterity.



FDA COMPLIANT

MODEL NO.	DESCRIPTION	MIL	SIZE	GLOVES/BUCKET	PRICE PER BUCKET	
					1	2+
S-17135	Powder-Free	5	S, M, L, XL	500	\$70	\$60
S-17135G	Refill Bag				60	50

## EXAM GRADE

Meets strict industry standards for medical use and food preparation.

- Fits either hand.
- Excellent fingertip sensitivity.
- Conforms to hand for comfort and dexterity.



FDA COMPLIANT

\* 90/CARTON

MODEL NO.	DESCRIPTION	MIL	SIZE	GLOVES/CARTON	PRICE PER CARTON	
					2	10+
S-9642	Powder-Free	5	S, M, L, XL*	100	\$15	\$13

# ULINE BLACK LATEX GLOVES

Ultra smooth – Slides on like butter.

FDA COMPLIANT

MODEL NO.	DESCRIPTION	MIL	SIZE	GLOVES/CARTON	PRICE PER CARTON	
					2	10+
S-19810	Powder-Free	5	S, M, L, XL	100	\$16	\$14

## INDUSTRIAL

- Used by spa workers and hairstylists.
- Specially treated for superior grip and feel.



# ULINE EXTENDED CUFF

## EXAM GRADE LATEX

Extra-thick for hospitals and waste management.

- Textured fingertips for secure grip.
- 12" extended cuff protects wrist and forearm.



FDA COMPLIANT

MODEL NO.	DESCRIPTION	MIL	SIZE	GLOVES/CARTON	PRICE PER CARTON	
					2	10+
S-17904	Powder-Free	12	S, M, L, XL	50	\$19	\$17

# ULINE TOUGH GRIP

## EXAM GRADE LATEX

Puncture resistant. Preferred by police and medical personnel.

- Textured fingertips for secure grip.
- Comfortable, contoured fit.



FDA COMPLIANT

MODEL NO.	DESCRIPTION	MIL	SIZE	GLOVES/CARTON	PRICE PER CARTON	
					2	10+
S-19177	Powder-Free	7	S, M, L, XL	100	\$17	\$15

# KIMBERLY-CLARK® NITRILE GLOVES



## EXAM GRADE KIMTECH™ PURPLE

Provides a barrier from infectious substances.

- Textured fingertips offer a sure grip.
- Latex and allergy-free.
- Puncture resistant.

**S-20802 Extended Cuff** – 12" extended cuff protects wrist and forearm from splashes.

## INDUSTRIAL KLEENGUARD™ G10 2PRO™

Protect against chemicals and abrasives.

- Textured fingertips.
- Latex and allergy-free.
- Puncture resistant.

### EXAM GRADE KIMTECH™ PURPLE

MODEL NO.	DESCRIPTION	MIL	SIZE	GLOVES/CARTON	PRICE/CARTON	
					2	10+
S-9863	Powder-Free	6	XS, S, M, L, XL*	100	\$39	\$37
S-20802				50		

\*90/CARTON

### INDUSTRIAL KLEENGUARD™ G10 2PRO™

MODEL NO.	DESCRIPTION	MIL	SIZE	GLOVES/CARTON	PRICE/CARTON	
					2	10+
S-12490	Powder-Free	6	XS, S, M, L, XL*	100	\$40	\$38

\*90/CARTON

# ANSELL TOUCH N TUFF® NITRILE GLOVES



## INDUSTRIAL 92-600

For chemical labs and food processing.

- Outstanding puncture resistance.
- Latex and silicone-free.
- Powdered, see [uline.com](http://uline.com)



## INDUSTRIAL 92-675

For assembly and light maintenance.

- Soft and comfortable.
- Textured fingertips.
- Latex and allergy-free.

MODEL NO.	DESCRIPTION	MIL	SIZE	GLOVES/CARTON	PRICE/CARTON	
					2	10+
S-15364	Powder-Free	5	S, M, L, XL	100	\$22	\$20

MODEL NO.	DESCRIPTION	MIL	SIZE	GLOVES/CARTON	PRICE/CARTON	
					2	10+
S-17204	Powder-Free	5	S, M, L, XL	100	\$20	\$18

# SHOWA® NITRILE GLOVES



## SHOWA® 7500

Protection for janitorial and maintenance applications.

- Textured fingertips.
- Latex-free.
- Resist punctures and chemicals.

## N-DEX® 7705PFT

Hi-vis lime, allergy-free gloves for laboratories and pharmacies.

- Color-code operations.
- Accelerator-free.
- 100% nitrile.



## INDUSTRIAL

### N-DEX®

Used by mechanics, law enforcement and maintenance.

- Hide dirt and grime.
- Minimize static.
- Textured fingertips.

**S-18047 N-Dex® 9700PF** – 11" extended cuff protects wrist and forearm.

FDA COMPLIANT

\*90/CARTON

MODEL NO.	DESCRIPTION	MIL	SIZE	GLOVES/CARTON	PRICE/CARTON	
					2	10+
S-15361	Powder-Free	4	S, M, L, XL, 2XL*	100	\$21	\$19
S-13406	Powder-Free	4	S, M, L, XL	50	18	16
S-18047		26			24	
S-13405	Powder-Free	4	S, M, L, XL	100	25	23



# ULINE INDUSTRIAL NITRILE GLOVES

## COMFORT

Provides total comfort and sensitivity.

- Easy to put on and take off.
- Latex and allergy-free.
- Puncture resistant.



FDA COMPLIANT

\* 180/CARTON

MODEL NO.	DESCRIPTION	MIL	SIZE	GLOVES/CARTON	PRICE/CARTON	
					2	10+
S-16768	Powder-Free	3	S, M, L, XL*	200	\$23	\$21

## INDUSTRIAL BLACK

Hides dirt, grease, grime.

- For mechanics, industrial workers, homeland security.
- Easy on. Good tactile sensitivity.
- Beaded cuff. Latex-free.



FDA COMPLIANT

MODEL NO.	DESCRIPTION	MIL	SIZE	GLOVES/CARTON	PRICE/CARTON	
					2	10+
S-23309	Powder-Free	4	S, M, L, XL	100	\$13 any ctn. qty.	
S-16767		6	S, M, L, XL, 2XL		\$19	\$17



## INDUSTRIAL

Protect against chemicals and abrasives.

- Puncture resistant.
- Latex and allergy-free.

**S-14181 Extended Cuff** – Protects wrist and forearm from splashes and abrasives.

FDA COMPLIANT

\* 90/CARTON

MODEL NO.	DESCRIPTION	MIL	SIZE	GLOVES/CARTON	PRICE/CARTON	
					2	10+
S-14179	Powder-Free	4	XS, S, M, L, XL, 2XL*	100	\$15	\$13
S-7963	Powdered Powder-Free	6	S, M, L, XL	100	19	17
S-9643		6	S, M, L, XL*		19	17
S-14180	Powder-Free	8	S, M, L, XL	50	19	17

## EXTENDED CUFF

S-14181	Powder-Free	6	S, M, L, XL	50	\$19	\$17
---------	-------------	---	-------------	----	------	------

# ULINE NITRILE GLOVES

## EXAM GRADE

Protect hands from germs, fluids and infectious disease.

- Non-slip textured fingertips for secure grip.
- Latex and allergy-free. Puncture resistant.

Blue – Ultra comfortable for all-day wear.



S-21081

### BLACK

Hides stains, inks and dyes. For EMTs and crime scene investigators.



S-21082

### WHITE

Superior sensitivity for medical and dental use.



S-12549

### ORANGE

High visibility for emergency responders and outdoor workers. Extended cuff.



S-19251

### ANSELL ALOE

Eliminates skin irritation with soothing inner coating. Beaded cuff.



S-15391

FDA COMPLIANT

MODEL NO.	DESCRIPTION	MIL	SIZE	GLOVES/CARTON	PRICE/CARTON	
					2	10+
S-12549	Powder-Free	4	S, M, L, XL	100	\$17	\$15
S-21081		4	S, M, L, XL	100	18	16
S-21082		3	S, M, L, XL	200	22	20

FDA COMPLIANT

MODEL NO.	DESCRIPTION	MIL	SIZE	GLOVES/CARTON	PRICE/CARTON	
					2	10+
S-19251	Powder-Free	5	S, M, L, XL	100	\$25	\$23
S-15391		3	S, M, L, XL		37	35

# ULINE GLOVES IN A BUCKET

## INDUSTRIAL NITRILE



Portable, economical and convenient. Holds 5 times more gloves than a carton. Stackable, square container.

- Airtight cover keeps gloves clean, dry and undamaged.
- Puncture-resistant nitrile. • Latex and powder-free.

**Black** – Hides dirt and grease. For mechanics, contractors and maintenance crews. Fully textured.

**Blue** – Superior comfort. For packing stations and janitorial work.



### BLACK INDUSTRIAL

MODEL NO.	DESCRIPTION	MIL	SIZE	GLOVES/BUCKET	FDA COMPLIANT PRICE PER BUCKET	
					1	2+
S-21079	Bucket	6	S, M, L, XL	500	\$90	\$85
S-21079G	Refill Bag				80	75

### BLUE INDUSTRIAL

MODEL NO.	DESCRIPTION	MIL	SIZE	GLOVES/BUCKET	FDA COMPLIANT PRICE PER BUCKET		
					1	2+	10+
S-15590	Bucket	6	S, M, L, XL	500	\$90	\$85	
S-15590G	Refill Bag				80	75	
S-15639*	Carton				100	2/\$20	10+/\$18

\* MIN. 2

# ULINE SECURE GRIP™ GLOVES

## INDUSTRIAL NITRILE



Get a grip! Easily handle greasy tools and parts when doing maintenance and repairs.

- Raised diamond texture on fingers and palms.
- Beaded cuff. • Latex and powder-free.

**Bucket** – Portable and convenient. Holds 6 times more gloves than a carton.



SPECIFY COLOR: Black or Orange

FDA COMPLIANT

MODEL NO.	DESCRIPTION	MIL	SIZE	GLOVES/BUCKET	PRICE PER BUCKET	
					1	2+
S-22784	Bucket	8	M, L, XL	300	\$100	\$95
S-22784G	Refill Bag				90	85
S-20863*	Carton				50	2/\$20

\* MIN. 2



### WIRE

Industrial duty. PVC coated.

MODEL NO.	HOLDS NO. OF BOXES	SIZE W x H x D	PRICE EACH	
			1	4+
H-1645	1	11 x 4 x 4"	\$16	\$14
H-6119	2	11 x 11 x 4"	20	18
H-1646	3	11 x 14 x 4"	25	23
H-4180	4	11 x 22 x 4"	29	27

# GLOVE DISPENSERS

## COUNTERTOP OR WALL MOUNT



### ACRYLIC

Attractive, clear, professional.

MODEL NO.	HOLDS NO. OF BOXES	SIZE W x H x D	PRICE EACH	
			1	4+
H-1647	1	11 x 5 x 4"	\$27	\$25
H-6120	2	11 x 10 x 4"	31	29
H-1648	3	11 x 15 x 4"	42	39
H-9088	4	11 x 20 x 4"	50	45



### STAINLESS STEEL

Heavy duty, 18 gauge.

MODEL NO.	HOLDS NO. OF BOXES	SIZE W x H x D	PRICE EACH	
			1	4+
H-6121	1	6 x 11 x 4"	\$70	\$67
H-9047	2	10 x 11 x 4"	80	75
H-6122	3	10 x 17 x 4"	95	90
H-8279	4	10 x 22 x 4"	105	100

# ULINE FOOD SERVICE GLOVES

## VINYL

Wide range of applications in janitorial and food service.

- Provides excellent manual dexterity.
- Blue aids contamination control.
- Latex and allergy-free.

\* SPECIFY COLOR: Clear or Blue

MODEL NO.	DESCRIPTION	MIL	COLOR	SIZE	QTY./CTN.	PRICE PER CARTON	
						2	10+
S-15388	Powdered	3	Clear	S, M, L, XL	100	\$11	\$9
S-15389	Powder-Free						
S-15390*	Powdered	5	Clear or Blue	S, M, L, XL	100	13	11
S-15392*	Powder-Free						



## POLY

For light-duty food applications such as sandwich making.

**Poly Glove** – Embossed for easy grip.

**Shoulder Length Glove** – Maximum coverage. Elastic band holds sleeve up. 35" long.

**Sleeve** – Polyethylene with elastic at both ends. 18" long.

FDA COMPLIANT

\* SPECIFY COLOR: White or Blue

MODEL NO.	DESCRIPTION	MIL	SIZE	QTY./CTN.	PRICE PER CARTON	
					2	5+
S-7895	Clear Poly Gloves	1	One Size	500	\$8	\$6
S-20329	Clear Shoulder Length	1.25	One Size	100	20	18
S-11430*	Poly Sleeve	1	One Size	2,000	\$102 ea. / 2+ \$97	

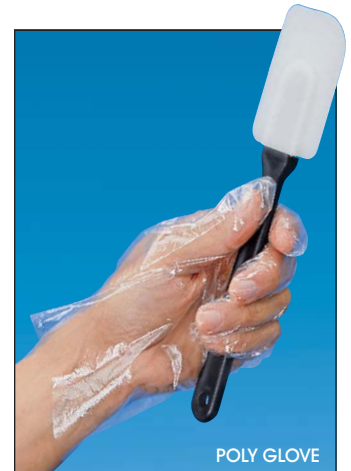

## FINGER COTS

3 MIL

MODEL NO.	DESCRIPTION	TYPE	SIZE	QTY./CTN.	PRICE/CARTON	
					2	10+
S-11468	Powdered	Latex	S, M, L, XL	1,440	\$29	\$28
S-11469	Powder-Free					16
S-15365	Powder-Free	Nitrile	S, M, L, XL	720	46	42
H-1284	Finger Cot Dispenser – 13 x 6 x 8"				\$70 each	

Excellent fingertip dexterity.

**Latex** – Textured for easy grip.

**Nitrile** – Resists epoxies, glues and chemicals.

**Acrylic Dispenser** – Holds 1,440 cots.



## STEEL MESH GLOVE

Butcher the chicken, not your hand.

- Steel-ring glove provides ultimate cut and slash protection.
- Stainless steel resists fats and oils. Easy to clean.
- Ambidextrous. Adjustable wrist strap.



FDA COMPLIANT

MODEL NO.	DESCRIPTION	ANSI CUT LEVEL	SIZE	PRICE PER GLOVE		
				1	2	3+
S-18009	Steel Mesh	A9	S, M, L, XL	\$165	\$155	\$145

## ULINE FOOD SERVICE GLOVES

### SIMPLE TOUCH NITRILE

Ultra thin form-fitting comfort for food handling and prep.

- Excellent sensitivity and dexterity.
- Blue aids contamination control.
- Strong and durable. Puncture resistant.



FDA COMPLIANT

SPECIFY COLOR: Clear or Blue

MODEL NO.	DESCRIPTION	MIL	SIZE	QTY./CTN.	PRICE/CARTON	
					2	10+
S-22776	Powder-Free	2	S, M, L, XL	100	\$17	\$15



# CHEMICAL RESISTANT GLOVES



Protection from heavy-duty chemicals, grease and fats.

- Contoured fit with textured finish for wet/dry grip.
- Puncture, abrasion and cut resistant. • FDA compliant.

**S-19714 Extended Cuff** – Protects wrist and forearm.

**S-7964 and S-15398** – Flock-lined.

## ULINE NITRILE

\* Flock-lined

MODEL NO.	LENGTH	MIL	RECOMMENDED USE	SIZE	QTY./CTN.	PRICE PER CARTON	
						1	2+
S-7964*	12"	15	Food Processing	S, M, L, XL, 2XL	12 Pair	\$21	\$20

## ANSELL ALPHATEC® SOL-VEX® NITRILE GLOVES

\* Flock-lined

MODEL NO.	LENGTH	MIL	RECOMMENDED USE	SIZE	QTY./CTN.	PRICE PER CARTON	
						1	2+
S-19709	13"	11	Janitorial/Sanitization	S, M, L, XL, 2XL	12 Pair	\$25	\$23
S-19710		15	Chemical Spraying			\$35	\$32
S-15398*		17				\$29	\$27

## ANSELL ALPHATEC® SOL-VEX® EXTENDED CUFF

MODEL NO.	LENGTH	MIL	RECOMMENDED USE	SIZE	QTY./CTN.	PRICE PER PAIR	
						1	6+
S-19714	18"	22	Oil Refining	S, M, L, XL, 2XL	12 Pair	\$15	\$14



S-19709



S-19714



## SHOWA® ATLAS® 772 NITRILE

Full arm protection for tank cleaning and chemical spraying.

- Cotton-lined with elastic band.
- Rough-finish grip.
- Oil and puncture resistant.



## LATEX

Comfortable for general cleaning.

- Traditional 12" "Canner's" glove with nonslip grip.
- Cotton-flock lining available.



## NEOPRENE COATED LATEX

Extra-thick protection for manufacturing or painting.

- Dual-color design – replace when blue wears off of yellow.
- Nonslip diamond grip.

MIN. ORDER 2 PAIRS

MODEL NO.	LENGTH	MIL	SIZE	QTY./CTN.	PRICE/PAIR	
					2	6+
S-21080	26"	30	M, L, XL	72 Pair	\$17	\$16

\* Blue

MODEL NO.	DESC.	MIL	SIZE	QTY./CTN.	PRICE/CTN.	
					1	2+
S-9721	Lined	20	S, M, L, XL, 2XL	12 Pair	\$15	\$14
S-11433*	Unlined	18	S, M, L, XL, 2XL	12 Pair	\$15	\$14

Flock-lined

MODEL NO.	LENGTH	MIL	SIZE	QTY./CTN.	PRICE/CTN.	
					1	2+
S-15396	12"	28	S, M, L, XL	12 Pair	\$23	\$21

## NEOPRENE



Nonslip grip in wet or oily conditions.

- 12" with cotton liner or 18" unlined elbow lengths available.
- Rugged, multi-layer construction.

\* Black

MIN. ORDER 4 PAIRS

MODEL NO.	LENGTH	MIL	SIZE	QTY./CTN.	PRICE/PAIR	
					4	12+
S-9722	12"	15	M, L, XL	12 Pair	\$8	\$7
S-11434*	18"	22	M, L, XL	12 Pair	\$26	\$25

## BUTYL RUBBER



Protection from toxic chemicals for security and hazmat teams.

- Unlined. Ultra smooth, flexible.
- Highest barrier resistance to gases and vapors.

MODEL NO.	LENGTH	MIL	SIZE	QTY./CTN.	PRICE/PAIR	
					1	3+
S-19727	14"	14	M, L, XL	36 Pair	\$41	\$39

## THERMAL SHIELD



### SUPER GRIPTION® THERMAL SHIELD

For cold and frozen food distribution.

- Palm and fingers stay dry with 3/4 nitrile coating.
- Comfortable, flexible acrylic liner.

MODEL NO.	SIZE	QTY./CTN.	PRICE PER CARTON	
			1	2+
S-22778	S, M, L, XL	12 Pair	\$65	\$62

# POLYURETHANE COATED GLOVES

## ULINE

Breathable comfort for general maintenance and assembly work.

- Knit wrist cuffs.

**BLACK** – For dry janitorial work and maintenance. Nylon knit liner.

**WHITE** – Low lint. For inspecting and packaging. Nylon knit liner.

**GRAY** – For electrical wiring and installation. Nylon knit liner.

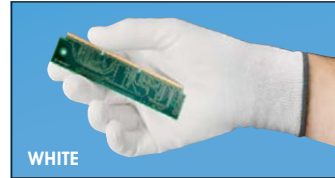

MODEL NO.	DESCRIPTION	SIZE	GAUGE	QTY./CTN.	PRICE PER CARTON	
					1	2+
S-14317	Uline Black	S, M, L, XL	13	12 Pair		
S-14316	Uline White					
S-19889	Uline Gray					



### ULINE ULTRA-LITE

Ultra sheer liner for handling the smallest parts.

- Cool for all-day comfort.
- Polyurethane coating resists abrasion.

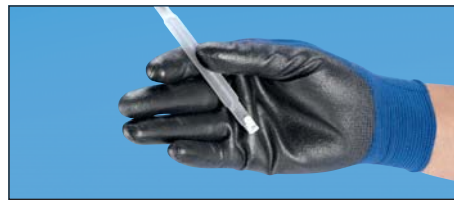

### NINJA LITE

Extra-thin sensitivity for optics and microprocessing.

- Featherlight gloves.
- Soft black coating conceals dirt and grime.



### ANSELL HYFLEX® 11-600

Enhanced dexterity for electronics assembly.

- Ultra cool stretch nylon liner.
- Light coating with excellent protection.

#### 18 GAUGE

MODEL NO.	SIZE	QTY./CTN.	PRICE/CARTON	
			1	2+
S-21088	S, M, L, XL	12 Pair	\$26	\$24

#### 18 GAUGE

MODEL NO.	SIZE	QTY./CTN.	PRICE/CARTON	
			1	2+
S-14319	S, M, L, XL	12 Pair	\$47	\$43

#### 15 GAUGE

SPECIFY COLOR: Black or White

MODEL NO.	SIZE	QTY./CTN.	PRICE/CARTON	
			1	2+
S-17134	S, M, L, XL	12 Pair	\$41	\$37

# FLAT NITRILE COATED GLOVES

## DRY GRIP

High tack coating creates a secure grip for handling glass and metal. Abrasion resistant.

**ULINE NITRILE** – Recommended for small parts assembly. Nylon knit.

**ANSELL HYFLEX® 11-900** – Easily handle ceramic tile and drywall. Nylon shell and liner.

**SHOWA® ATLAS® 370** – Used for roofing and construction. Nylon liner with durable coating.



MODEL NO.	DESCRIPTION	SIZE	QTY./CTN.	PRICE/CARTON	
				1	2+
S-14318	Uline Nitrile	S, M, L, XL	12 Pair	\$33	\$30
S-17310	Ansell HyFlex® 11-900			50	45

MODEL NO.	DESCRIPTION	SIZE	QTY./CTN.	PRICE/CARTON	
				1	2+
S-19891	Showa® Atlas® 370	S, M, L, XL	12 Pair	\$52	\$47

# NITRILE COATED GLOVES

## FOAM NITRILE



### OILY/WET GRIP

Maintains a firm nonslip grip on slick, oily surfaces.

**ULINE FOAM** – Grip in oily, greasy applications. Superior sensitivity, abrasion resistance.

**ULINE SUPER GRIPTION®** – Double coating. Oil won't soak through.

**ANSELL HYFLEX® FOAM** – Exceptional fit. Excellent nonslip grip in wet/oily applications.

SPECIFY COLOR: White/Gray or Gray/Black

MODEL NO.	DESCRIPTION	SIZE	QTY./ CARTON	PRICE PER CARTON	
				1	2+
S-11435	Uline Foam	S, M, L, XL	12 Pair	\$45	\$40
S-19890	Uline Super Gription®			\$39 any ctn. qty.	

MODEL NO.	DESCRIPTION	SIZE	QTY./ CARTON	PRICE PER CARTON	
				1	2+
S-15572	Ansell HyFlex® Foam	S, M, L, XL	12 Pair	\$66	\$61

## ULINE MICRO-FOAM NITRILE



### MAX COMFORT/DRY GRIP

Micro-foam construction with breathable coating keeps hands cool and dry.

**ULINE COOLFLEX™** – Excellent dexterity for parts assembly. Nylon liner.

**ULINE COOLFLEX™ ULTRA** – Micro-dot palm improves grip for box handling.

**ULINE COOLFLEX™ ULTRA 3/4** – For carpentry and landscaping. Micro-dot palm 3/4 coating.

MODEL NO.	DESCRIPTION	SIZE	QTY./ CARTON	PRICE PER CARTON	
				1	2+
S-21083	Uline CoolFlex™	S, M, L, XL	12 Pair	\$39	\$35
S-23340	Uline CoolFlex™ Ultra			45	40

MODEL NO.	DESCRIPTION	SIZE	QTY./ CARTON	PRICE PER CARTON	
				1	2+
S-23999	Uline CoolFlex™ Ultra 3/4	S, M, L, XL	12 Pair	\$50	\$45

## MAXIFLEX® MICRO-FOAM NITRILE



### MAX COMFORT/DRY GRIP

Micro-foam construction provides ultra-cool comfort for all-day use.

**MAXIFLEX® 34-874** – For HVAC installation and repair. Nylon liner.

**MAXIFLEX® 34-844** – Micro-dot palm. Extends glove life for packing.

**MAXIFLEX® 34-845** – For mechanics working in tight spaces. Micro-dot palm. 3/4 coating. Knuckle protection.

MODEL NO.	DESCRIPTION	SIZE	QTY./ CARTON	PRICE PER CARTON	
				1	2+
S-20732	MaxiFlex® 34-874	S, M, L, XL	12 Pair	\$70	\$65
S-21496	MaxiFlex® 34-844			76	71

MODEL NO.	DESCRIPTION	SIZE	QTY./ CARTON	PRICE PER CARTON	
				1	2+
S-22777	MaxiFlex® 34-845	M, L, XL	12 Pair	\$81	\$76



# LATEX COATED GLOVES

## ULINE GRIPTION® FLEX

- Lightweight nylon liner for comfort.
- Crinkle-coated palms and fingers for grip.

## ULINE GRIPTION®

- Crinkle finish for excellent "gription."
- Thick polyester liner.

## SHOWA® ATLAS® 300

- Naturally contoured fingers for comfort.
- Durable poly/cotton liner. Crinkle finish.

## NINJA® FLEX

- Soft nylon liner provides increased dexterity and comfort. Crinkle finish.



MODEL NO.	DESCRIPTION	SIZE	QTY./ CARTON	PRICE PER CARTON	
				1	2+
S-16882*	Uline Gription® Flex	S, M, L, XL	12 Pair	\$27 any ctn. qty.	
S-9634	Uline Gription®			\$33	\$30

MODEL NO.	DESCRIPTION	SIZE	QTY./ CARTON	PRICE PER CARTON	
				1	2+
S-15571	Showa® Atlas® 300	S, M, L, XL	12 Pair	\$39	\$37
S-13464	Ninja® Flex			45	40

\*Also available in Black

# ULINE DELUXE LATEX COATED GLOVES



The ultimate warehouse glove. Pick up boxes with half the effort. Feel fresh even after a hard shift.

S-15332 – Durable. Heavy-duty poly/cotton liner.

S-15333 – Lightweight. Cool, flexible nylon liner.

\*SPECIFY COLOR: Blue or Black

MODEL NO.	DESCRIPTION	SIZE	QTY./ CTN.	PRICE PER CARTON	
				1	2+
S-15332	Super Gription®	S, M, L, XL	12 Pair	\$41	\$38
S-15333*	Super Gription® Flex	S, M, L, XL	12 Pair	\$39 any ctn. qty.	

## PATENTED GRIPTION® TECHNOLOGY



# ULINE THERMAL COATED GLOVES

## COLD WEATHER



## ULINE THERMAL

Thermal acrylic liner keeps hands warm in cold conditions.

- Crinkle finish for excellent "gription."

SPECIFY COLOR: Orange or Black

MODEL NO.	SIZE	QTY./ CTN.	PRICE/CARTON	
			1	2+
S-16857	S, M, L, XL	12 Pair	\$41	\$38



## ULINE SUPER GRIPTION® THERMAL

Thermal acrylic liner keeps hands warm and comfortable.

- Long-lasting glove with super grip.

MODEL NO.	COLOR	SIZE	QTY./ CTN.	PRICE/CARTON	
				1	2+
S-19884	Gray	S, M, L, XL	12 Pair	\$53	\$50
S-19885	Hi-Vis	S, M, L, XL	12 Pair	\$53	\$50



## ULINE DURARMOR™ ICE

Warmth and cut level A4 protection combined for cold storage use.

- HPPE blended liner with coated palm.

SPECIFY COLOR: Lime or Black

MODEL NO.	ANSI CUT LEVEL	SIZE	QTY./ CTN.	PRICE/CARTON	
				1	2+
S-24002	A4	S, M, L, XL	12 Pair	\$75	\$70



SAFETY CUFF



INDUSTRIAL SAFETY CUFF



DOUBLE PALM



DELUXE LEATHER PALM

# LEATHER PALM GLOVES

## SAFETY CUFF

Soft, flexible wear for warehouse and landscaping tasks. 2½" cuff.

## INDUSTRIAL SAFETY CUFF

Thicker, more durable for handling rough objects in construction and maintenance. 2½" cuff.

## DOUBLE PALM

Rugged, long lasting, abrasion proof. Use for steel, cable, foundry, lumberjack work. Double layer palm, thumb, pinky and index finger.

## DELUXE LEATHER PALM

Cowhide leather provides great comfort. Used in construction and masonry work. Washable. Leather knuckles, index finger and fingertips.

MODEL NO.	DESCRIPTION	SIZE	QTY./PACK	PRICE PER PACK		
				1	3	6+
S-21620	Safety Cuff	M, L, XL	12 Pair	\$36	\$34	\$32
S-16907	Industrial Safety Cuff			44	42	40
S-11431	Double Palm Leather			55	53	51
S-16851	Deluxe Leather Palm			83	81	79

# LEATHER DRIVERS



## PIGSKIN GLOVES

Economical. Withstands moisture without stiffening. Softens with use.

- Uses – Landscaping, outdoor jobs.

Lined – For cold weather work.

MODEL NO.	DESCRIPTION	SIZE	QTY./PACK	PRICE PER PAIR		
				3	12	24+
S-14248	Pigskin Drivers	M, L, XL	3 Pair	\$10	\$9	\$8
S-16848	Lined Pigskin Drivers			11	10	9



## COWHIDE GLOVES

Favorite of truck and forklift drivers. Hands are insulated from heat and cold.

- Uses – Framing, carpentry, utility work.

Lined – Extra comfort and warmth.

MODEL NO.	DESCRIPTION	SIZE	QTY./PACK	PRICE PER PAIR		
				3	12	24+
S-6777	Cowhide Drivers	M, L, XL	3 Pair	\$11	\$10	\$9
S-10443	Lined Cowhide Drivers			12	11	10



## DELUXE COWHIDE GLOVES

Tailored fit. Quality leather for excellent durability.

- Uses – Machine operations and material handling.
- Wrist secured – Ball and tape wrist strap for secure fit to keep out debris.

MODEL NO.	DESCRIPTION	SIZE	QTY./PACK	PRICE PER PAIR		
				3	12	24+
S-16849	Cowhide Drivers w/ Strap	M, L, XL	3 Pair	\$13	\$12	\$11



## GOATSKIN GLOVES

Super soft. Exceptional dexterity with excellent abrasion resistance.

- Uses – Assembly, fabrication, utility jobs.
- Flexible – Thin and pliable for finger sensitivity.

MODEL NO.	DESCRIPTION	SIZE	QTY./PACK	PRICE PER PAIR		
				3	12	24+
S-16850	Goatskin Drivers	M, L, XL	3 Pair	\$14	\$13	\$12



# JAGUAR™ LEATHER PALM GLOVES

The ultimate work glove. Looks good in the warehouse or out on the town.

- The softest goatskin out there.
- Full polyester lining and knit wrist.
- Stretchy backing for ultimate comfort.

MODEL NO.	DESCRIPTION	SIZE	QTY./PACK	PRICE PER PAIR	
				3	12+
S-17495	Leather Palm	M, L, XL	3 Pair	\$9	\$8

Free upon request with any Uline order of \$300 or more.



# WAREHOUSE GLOVES

## DOT KNIT

PVC dots give superior grip.

- Breathable poly/cotton material.
- Ambidextrous with PVC dots on both sides for twice the wear.
- Machine washable.

### FOR GLOVE MEASUREMENTS:

Measure around widest part of palm for size. Ladies: S (7-8") Men's: S (7-8"), M (8-9"), L (9-10"), XL (10-11"), 2XL (11-12").

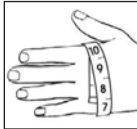

Fingerless and single-sided, see uline.com

SPECIFY COLOR:  Black  Red  Blue

MODEL NO.	DESCRIPTION	SIZE	QTY./PACK	PRICE PER PACK	
				1	3+
S-6778	PVC Dot Knit	S, M, L, XL	12 Pair	\$9 any pack quantity	



## COTTON JERSEY

Keep hands clean while handling warehouse materials. 8 oz. heavyweight. Lined – Slip on for cold weather. 14 oz.

\* SPECIFY COLOR:  Brown  White

MODEL NO.	DESC.	SIZE	QTY./PACK	PRICE/PACK	
				1	3+
S-812*	Jersey	Men's,	12	\$14	\$13
S-17200	Lined Jersey	Ladies'	Pair	31	29

S-17200: Men's only



## LATEX COATED STRING KNIT

When you need a better grip. Thin latex coating over knit cotton liner. For maintenance, packaging and assembly.

MODEL NO.	SIZE	QTY./PACK	PRICE/PACK	
			1	3+
S-17931	S, M, L, XL	12 Pair	\$13	\$12



## STRING KNIT

Economical gloves keep hands warm while working in the warehouse. Use alone or as liners.

MODEL NO.	SIZE	QTY./PACK	PRICE PER PACK	
			1	3+
S-7891	Men's, Ladies'	12 Pair	\$6 any pack qty.	

# INSPECTION GLOVES

## COTTON

Keep sensitive products clean from fingerprints and smudges.

- Form-fitting for easy movement.

## NYLON

Low lint for extra-clean product inspection.

- Prevents smudges and fingerprints.

## DELUXE NYLON

Lint-free ultra fine for the most sensitive inspections.

- Seamless nylon is reversible.



### 100% COTTON

MODEL NO.	DESCRIPTION	LENGTH	SIZE	QTY./CTN.	* 7 1/2" Length			
					1	5	10+	
S-7892	Light Weight	2.5 oz.	9"	Men's, Ladies'*	12 Pair	\$7	\$6	\$5
S-19283				Jumbo	9	8	7	
S-17932	Light Weight	2.5 oz.	14"	Men's	12 Pair	10	9	8
S-15384	Medium Wt.	3.5 oz.	9"	Men's or Ladies'*	12 Pair	11	10	9
S-19284	Heavy Wt.	5.5 oz.	9"			12	11	10

### NYLON

MODEL NO.	DESCRIPTION	SIZE	QTY./CTN.	PRICE/CTN.	
				1	2+
S-16909	40 Denier Nylon	Men's L, XL	12 Pair	\$11	\$10
S-16908	40 Denier Nylon	Ladies' L, XL			
S-19882	70 Denier Deluxe Nylon	S, M, L, XL	12 Pair	11	10



# IRONCLAD® GLOVES



## BOX HANDLER®

For slippery surfaces such as import boxes and heavy kraft paper rolls.

- Super-tacky "Diamondclad™" palm and fingertips.
- Knuckle impact protection. Terry cloth sweat wipe.
- Abrasion and wear resistant. • Breathable and washable.

MODEL NO.	DESCRIPTION	SIZE	PRICE PER PAIR	
			1	3+
S-11436	Box Handler®	S, M, L, XL, 2XL	<b>\$27 per pair any quantity</b>	



## GENERAL UTILITY™

Protection for daily tasks.

- Synthetic leather reinforcement on palm and fingers.
- Rubberized knuckle protection.

MODEL NO.	SIZE	PRICE PER PAIR	
		1	3+
S-17151	M, L, XL, 2XL	\$25	\$23



## COLD CONDITION®

Keeps hands warm in the cold.

- Ironclad® coating repels water and oil.
- Windproof and abrasion resistant.
- For temperatures down to 40°F.

MODEL NO.	SIZE	PRICE PER PAIR	
		1	3+
S-12568	M, L, XL, 2XL	\$32	\$30



## TUNDRA®

The ultimate cold weather work glove.

- Waterproof Cryoflex® shell fits like a ski glove.
- Keeps hands warm down to 0°F.

MODEL NO.	SIZE	PRICE PER PAIR	
		1	3+
S-17152	M, L, XL, 2XL	\$62	\$59

# MECHANIX® GLOVES



## FASTFIT®

Flexible hand protection for workers.

- Comfortable, lightweight.
- Easy to slip on and off.



## ORIGINAL

#1 choice of pro mechanics.

- Patented stretch spandex fits like "second skin."
- Protection from cuts and scrapes.

SPECIFY COLOR: ■ Black ■ Red ■ Blue ■ Camo ■ Yellow ■ Lime

MODEL NO.	DESCRIPTION	SIZE	PRICE PER PAIR	
			1	3+
S-12566*	Fastfit®	S, M, L, XL, 2XL	\$19	\$17
S-10441	Original		28	26

\* Not available in Camo, Yellow or Lime



## ORIGINAL VENT

Hands stay cool on the hottest days.

- Vent holes let hands breathe.
- Handy terry cloth pad on thumb to wipe sweat.



## M-PACT®

Reduce vibration when changing motors.

- Double-padded palm and knuckles.
- Wrist strap to ensure snug fit.

MODEL NO.	DESCRIPTION	SIZE	PRICE PER PAIR	
			1	3+
S-12567	Original Vent	S, M, L, XL, 2XL	\$30	\$28
S-11437	M-Pact®	M, L, XL	40	38



# ULINE PERFORMANCE IMPACT GLOVES

Full rubber backing prevents busted knuckles and crushed fingers.

- Padded palm absorbs shock and vibrations.
- Snug fit design with freedom to move.

SPECIFY COLOR: ■ Lime ■ Black

MODEL NO.	DESCRIPTION	SIZE	PRICE PER PAIR	
			1	3+
S-23997	Uline Impact	S, M, L, XL, 2XL	\$25	\$23

# ULINE PERFORMANCE GLOVES



## GRIPTION® GLOVES

Super-tacky palm and fingertips for a nonslip grip.

- Handle material handling, warehouse and construction jobs.
- Breathable, flexible for all-day use.

Hi-Vis Lime – Bright color for worksite visibility.

SPECIFY COLOR: ■ Red ■ Black ■ Blue ■ Lime ■ Yellow

MODEL NO.	DESCRIPTION	SIZE	PRICE PER PAIR	
			1	3+
S-12553	Gription® Gloves	S, M, L, XL, 2XL	<b>\$18 per pair any quantity</b>	

**MORE SAFETY AND INDUSTRIAL GLOVES**  
See [uline.com](http://uline.com)

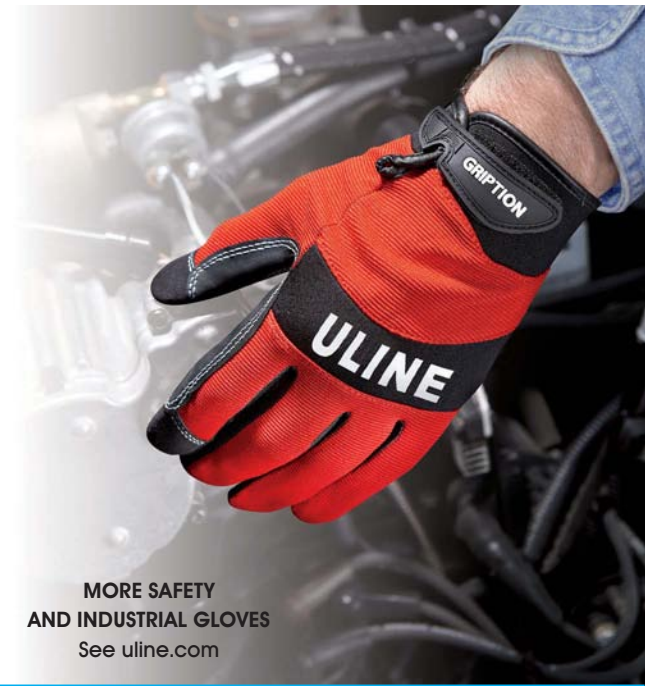

## QUICK ON™

Extra-wide cuffs make this glove easy to slip on and off.

- Comfort, dexterity and grip.
- All-purpose work gloves.

SPECIFY COLOR: ■ Blue ■ Black

MODEL NO.	SIZE	PRICE PER PAIR	
		1	3+
S-14116	S, M, L, XL, 2XL	\$12	\$9



## UTILITY

Hook and loop closure provides comfortable and secure fit.

- Lightweight spandex with synthetic leather palm.
- All-purpose work gloves.

SPECIFY COLOR: ■ Gray ■ Black

MODEL NO.	SIZE	PRICE PER PAIR	
		1	3+
S-19190	S, M, L, XL, 2XL	\$15	\$12



## HEAVY DUTY GRIPTION®

Thicker padded wrist support and knuckle guards. Wraparound cuff.

- Comfortably lift the heaviest loads indoors and outside.
- Breathable and flexible.

MODEL NO.	SIZE	PRICE PER PAIR	
		1	3+
S-15355	S, M, L, XL, 2XL	\$26	\$23



## HEAVY UTILITY

Reinforced palm and fingers for long wear.

- Stands up to tough conditions.
- Handle concrete, lumber and metal.

MODEL NO.	SIZE	PRICE PER PAIR	
		1	3+
S-16847	S, M, L, XL, 2XL	\$26	\$23



## ICE BUSTER™

Waterproof fleece liner keeps hands warm and dry.

- Use in temperatures down to 20°F.
- Reinforced synthetic leather palm.

MODEL NO.	SIZE	PRICE PER PAIR	
		1	3+
S-16846	S, M, L, XL, 2XL	\$39	\$35



## VORTEX™

Extreme protection for the coldest temperatures down to 0°F.

- Waterproof shell with 3M Thinsulate™ liner keeps hands warm and dry.

MODEL NO.	SIZE	PRICE PER PAIR	
		1	3+
S-23998	S, M, L, XL, 2XL	\$45	\$39



# CUT RESISTANT GLOVES



ULINE DURARMOR™



ULINE DURARMOR™ GRIP



ULINE DURARMOR™ STEALTH



ANSELL HYFLEX® 11-644

MODEL NO.	DESCRIPTION	ANSI CUT LEVEL	SIZE	QTY./ CARTON	PRICE PER PAIR (MIN. 3 PAIRS)		
					3	12	24+
S-20703	Uline Durarmor™	A2	S, M, L, XL	12 Pair	\$9	\$8	\$7
S-21574	Uline Durarmor™ Stealth				10	9	8
S-23342	Uline Durarmor™ Grip				10	9	8
S-19711	Ansell HyFlex® 11-644				13	12	11

## ULINE DURARMOR™

Flexibility and cut protection combined.

- For handling box cutters and strapping.
- Comfortable HPPE liner with polyurethane coating.

## ULINE DURARMOR™ STEALTH

Exceptional comfort and dexterity.

- Jet black color hides grease and grime.
- High performance liner with polyurethane coating.

## ULINE DURARMOR™ GRIP

Superior comfort and nonslip grip.

- Grasp glass and materials with half the effort.
- HPPE blended liner with latex coating.

## ANSELL HYFLEX® 11-644

Ideal combination of comfort and cut protection.

- Use in plastic fabrication.
- HPPE liner with polyurethane coating.

# ULINE HIGH CUT RESISTANT GLOVES



DURARMOR™ ELITE PLUS



DURARMOR™ ELITE



DURARMOR™ MAX

MODEL NO.	DESCRIPTION	ANSI CUT LEVEL	SIZE	QTY./ CARTON	PRICE PER PAIR (MIN. 3 PAIRS)		
					3	12	24+
S-22779	Durarmor™ Elite	A4	S, M, L, XL	12 Pair	\$13	\$12	\$11
S-22780	Durarmor™ Elite Plus	A6			15	14	13
S-24003	Durarmor™ Max	A8			17	16	15

## DURARMOR™ ELITE/ELITE PLUS

Premium cut resistance. Cool, flexible comfort for sheet metal handling.

- HPPE blended liner.
- Super Gription® nitrile coating maintains grip in wet/oily conditions.

## DURARMOR™ MAX

Superior cut level A8 protection recommended for construction and equipment manufacturing.

- Ultra durable HPPE blended liner with nitrile coating.

# ULINE HPPE CUT RESISTANT SLEEVES



Complete wrist to elbow protection.

- Ultra flexible HPPE.

MODEL NO.	ANSI CUT LEVEL	LENGTH	PRICE/SLEEVE (MIN. 4)	
			4	12+
S-22781	A2	18"	\$6	\$5

- A4 sleeve, see [uline.com](http://uline.com)
- SPECIFY COLOR: Black or Gray

# NEEDLESTICK GLOVES HEXARMOR® 9014



Highest needlestick resistance.

- For sharps and waste handling.

MODEL NO.	ANSI CUT LEVEL	SIZE	PRICE PER PAIR	
			1	3+
S-22766	A9	S, M, L, XL	\$71	\$68

- Patented palm protection.



# ULINE DYNEEMA® GLOVES

## DYNEEMA®

Superior cut resistance and comfort.

- For handling glass and sheet metal.
- Dyneema®, nylon/spandex blend with polyurethane palm and fingertips.

## DIAMOND FLEX

Elevated flexibility for maximum dexterity.

- For sharp parts assembly and inspection.
- Thin, 18-gauge Dyneema® Diamond liner with polyurethane coating.

## DIAMOND

Excellent strength, durability and cut resistance.

- For steel and appliance manufacturing.
- Dyneema® Diamond liner with Super Gription® nitrile coating.

## DIAMOND ELITE

Outstanding comfort, cut protection and grip.

- For demolition and construction.
- Ultra-cool Dyneema® Diamond liner with foam nitrile coating.



DYNEEMA®

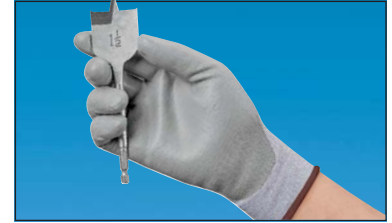

DIAMOND FLEX



DIAMOND

MODEL NO.	DESCRIPTION	ANSI CUT LEVEL	SIZE	QTY./ BOX	PRICE/PAIR (MIN. 3 PAIRS)		
					3	12	24+
S-14249	Dyneema®	A2	S, M, L, XL	12 Pair	\$13	\$12	\$11
S-24007	Diamond Flex	A3			13	12	11
S-23323	Diamond	A3			14	13	12
S-24006	Diamond Elite	A4			15	14	13

## ANSELL HYFLEX®



Excellent cut protection with a bare-hand feel.

- For precision handling of small, sharp parts.
- Cool, comfortable Dyneema® liner.
- Polyurethane coating resists abrasion.

MODEL NO.	DESCRIPTION	ANSI CUT LEVEL	SIZE	PRICE/PAIR (MIN. 3 PAIRS)		
				3	12	24+
S-19705	Ansell HyFlex® 11-518	A2	S, M, L, XL	\$15	\$14	\$13

## NINJA® MAX

Dyneema® with bi-polymer coating for metal fabrication.

- Protects hands without sacrificing comfort.
- Excellent cut and snag resistance.
- Breathable back.



MODEL NO.	DESCRIPTION	ANSI CUT LEVEL	SIZE	PRICE PER PAIR		
				1	3	12+
S-14320	Ninja® Max	A3	S, M, L, XL	\$23	\$22	\$21

## MAXIFLEX® CUT RESISTANT GLOVES

Exceptional comfort, sensitivity and cut protection.

- HPPE blended liner with micro-foam nitrile coating.

**MaxiFlex® 34-8743** – For drywall and wiring installation.

**MaxiFlex® 34-8443** – For automotive and machining. Dotted palm.

**MaxiCut® Ultra™ 44-3745** – For metal fabrication and assembly.



S-24024



S-23911

MODEL NO.	DESCRIPTION	ANSI CUT LEVEL	SIZE	PRICE/PAIR (MIN. 3 PAIRS)		
				3	12	24+
S-22150	MaxiFlex® 34-8743	A2	S, M, L, XL	\$13	\$12	\$11
S-24024	MaxiFlex® 34-8443			15	14	13
S-23911	MaxiCut® Ultra™ 44-3745	A3		20	19	18



S-22150

# WELDING SCREENS



Create a safe work area. Portable protection shields others from bright arcs and sparks.

- Flame-retardant vinyl curtain with heavy-duty grommets every 12".
- Easy assembly. Reusable cable ties included.
- H-5388 – Swivel casters provide mobility. Sold separately.

For UV and Clear Welding Screens, see [uline.com](http://uline.com)



No tools required. CFM approved.

SPECIFY COLOR: Orange, Shade 8, Blue or Yellow

MODEL NO.	DESCRIPTION	SIZE H x W	QTY./CASE	PRICE EACH		REPLACEMENT CURTAIN	
				1	3+	MODEL NO.	PRICE EACH
H-6699	Screen	6 x 4'	1	\$110	\$105	S-22158	\$24
H-4610		6 x 6'		125	120	S-20233	37
H-5179		6 x 8'		150	145	S-20855	49
H-6124		6 x 10'		175	170	S-21632	61
H-5388		Set of 4 Casters – Optional				1/\$24	2+/\$22

# COATED KEVLAR® GLOVES



RUBBER



SUPER GRIPTION®



FOAM NITRILE

## ULINE RUBBER

Easily grip knives, glass panes or sheet metal.

- Latex rubber coating provides additional puncture resistance.

## ULINE SUPER GRIPTION®

Latex coated Kevlar® glove with "super gription" finish when handling tools.

- Ideal for construction workers.

## FOAM NITRILE

Excellent wet, oily and dry grip.

- Form-fitting Kevlar®/Lycra® knit.
- Breathable and lightweight.

MODEL NO.	DESCRIPTION	ANSI CUT LEVEL	SIZE	QTY./CARTON	PRICE PER PAIR (MIN. 3 PAIRS)		
					3	12	24+
S-9867	Uline Rubber	A2	M, L, XL	12 Pair	\$10	\$9	\$8
S-15331	Uline Super Gription®				11	10	9
S-16858	Uline Foam Nitrile				9	8	7



DOT KNIT



INDUSTRIAL KNIT



SLEEVES

# KEVLAR® KNIT GLOVES

## DOT KNIT

PVC dots grab smooth or slippery surfaces.

- Ambidextrous with PVC dots on both sides for twice the wear.

## INDUSTRIAL KNIT

Strong, lightweight and flexible. Kevlar® fiber.

- Protects hands from cuts and abrasions.

## SLEEVES

Protects arms from cuts and abrasions. 18" wrist to elbow protection.

MODEL NO.	DESCRIPTION	ANSI CUT LEVEL	SIZE	QTY./CARTON	PRICE PER CARTON		
					1	3	5+
S-9866	PVC Dot Knit	A3	M, L, XL	12 Pair	\$99	\$97	\$95
S-7893	Industrial Knit				93	91	89
S-11432	Sleeve w/ Thumbhole	A3	One Size	-	4 / \$7 ea. 12+ / \$6 ea.		
S-21086	Sleeve w/o Thumbhole						



# BACK SUPPORT BELTS

MILLER® FALL PROTECTION, see pages 702-703

**ULINE INDUSTRIAL:** Flexible, ventilated elastic belt. Removable, adjustable shoulder straps.

- Inner supports prevent belt from curling over.
- Durable and machine washable.

**VALEO® DELUXE:** Alleviate back strain and prevent injury to lower back.

- Memory foam core – Keeps muscles warm for greater flexibility.
- Nylon belts are lightweight, washable and flexible.



**ULINE LUMBAR PAD:** Extra firm support – Lumbar pad molds perfectly to spine.

- Tear-away, adjustable shoulder straps.
- Durable and machine washable.

**ULINE ECONOMY:** Comfortable, durable support at an affordable price.



MODEL NO.	DESCRIPTION	WAIST SIZE OF BACK SUPPORT BELTS						WIDTH	COLOR	PRICE EACH		
		S	M	L	XL	2XL	3XL			1	3	5+
H-494	Uline Industrial	25-30"	30-34"	34-38"	38-42"	42-46"	46-52"	9"	Black	\$26 each any quantity		
H-367	Valeo® Deluxe	28-30"	31-35"	36-38"	39-42"	43-48"	-	4"	Black	\$34	\$32	\$30
H-381								6"		36	34	32
H-441	Uline Lumbar Pad	24-33"	34-38"	39-43"	44-48"	49-53"	54-60"	9"	Black	34	32	30
H-1168	Uline Economy	25-30"	30-34"	34-38"	38-42"	-	-	7"		N/A	17	16

## ULINE UNIVERSAL WAIST BELT

No need to buy extra work belts. Adjustable belt.

- Special polyester mesh keeps you cool and comfortable.
- Adjustable and removable suspenders.
- Hi-Vis – Added safety for workers in truck trailers and parking lots.

SPECIFY COLOR: Black, Lime or Orange

MODEL NO.	WAIST SIZE	WIDTH	COLOR	PRICE EACH		
				1	3	5+
H-855	Fits Waist Sizes 26-50"	9"	Specify	\$25 each any qty.		



## GRIPTION® CUT RESISTANT GLOVES

SPECIFY COLOR: Black or Lime

MODEL NO.	DESCRIPTION	ANSI CUT LEVEL	SIZE	PRICE PER PAIR	
				1	3+
S-23343	Gription® CR	A3	S, M, L, XL, 2XL	\$24	\$21

3-in-1 comfort, grip and cut protection. Breathable HPPE liner.

- Recommended for carpenters, machinists and contractors.







Fits securely over prescription glasses.

- Extremely comfortable, nonslip design.
- Anti-fog, anti-scratch lens. • 99.9% UV protection.

Meets ANSI Z87.1+

MODEL NO.	DESCRIPTION	LENS COLOR	PRICE EACH (MIN. 12)		
			12	24	72+
S-17940	OTG	Clear or Smoke	\$5.50	\$5.25	\$4.95

Superior comfort and style that fits over prescription glasses.

- Adjustable, padded temples and soft browguard.
- FogArmor™ enhanced anti-fog coating.

Meets ANSI Z87.1+

MODEL NO.	DESCRIPTION	LENS COLOR	PRICE EACH (MIN. 12)		
			12	24	72+
S-24597	Deluxe OTG	Clear or Smoke	\$8.00	\$7.50	\$7.00

## ULINE SAFETY EYEWEAR



**Rambler™** – Sporty, lightweight style with super soft nosepiece and temple.

- FogArmor™ enhanced anti-fog coating.
- 99.9% UV protection.

Meets ANSI Z87.1+

MODEL NO.	DESCRIPTION	LENS COLOR	PRICE EACH (MIN. 6)		
			6	12	24+
S-24606	Rambler™	Clear or Smoke	\$6.00	\$5.25	\$5.00



**Uline Safety Readers™** – No need to wear glasses over glasses.

- Bifocals for precision work.

\* Choose reading strength: 1.5, 2.0 or hard-to-find 1.75

Meets ANSI Z87.1+

MODEL NO.	DESCRIPTION	LENS COLOR	PRICE EACH (MIN. 2)		
			2	6	12+
S-22873*	Safety Readers	Clear	\$12	\$11	\$10

## KLEENGUARD™ SAFETY GLASSES



**Nemesis™** – Wraparound design with soft-touch temples for all-day comfort.

- Includes adjustable nylon strap.
- 99.9% UV protection.

Meets ANSI Z87.1+

MODEL NO.	DESCRIPTION	LENS COLOR	PRICE EACH (MIN. 6)		
			6	12	24+
S-19894	Nemesis™	Clear or Smoke	\$8.00	\$7.25	\$7.00



**KleenGuard™ Safety Readers™** – Eliminate the need to wear reading glasses under your safety glasses. Bifocal.

\* Choose reading strength:  
Clear 1.0, 1.5, 2.0, 2.5, 3.0  
Smoke 1.5, 2.0, 2.5

Meets ANSI Z87.1+

MODEL NO.	DESCRIPTION	LENS COLOR	PRICE EACH (MIN. 2)		
			2	6	12+
S-10493*	Safety Readers	Clear or Smoke	\$18	\$17	\$16



## ULINE FOAM SEALED EYEWEAR

Comfortable foam seals out dust and debris.

- Recommended for carpentry and landscaping.
- FogArmor™ enhanced anti-fog coating.
- Converts to goggles with adjustable headstrap.

Includes adjustable strap



Meets ANSI Z87.1+

MODEL NO.	DESCRIPTION	LENS COLOR	PRICE EACH (MIN. 2)		
			2	10	20+
S-24605	Impulse™	Clear or Smoke	\$9.00	\$8.50	\$8.00

# ULINE ICE WRAPAROUNDS

99.9% UV PROTECTION

Ultra popular safety glasses with wraparound lenses.

- Frameless, anti-scratch lenses for optimum vision.
- Guaranteed nonslip fit. • Meets ANSI Z87.1+.

Ice Petite – Better fit for small faces.

Anti-Fog – Stays clear in hot, humid conditions.

SPECIFY COLOR:



Silver Mirror    Amber    Smoke    Indoor/Outdoor    Blue

MODEL NO.	DESCRIPTION	LENS COLOR	PRICE EACH (MIN. 12)		
			12	24	48+
S-13390	Standard	Specify Color	\$2.50	\$2.25	\$2.00
S-20704▲	Ice Petite				
S-21076*	Anti-Fog		3.00	2.75	2.50
S-17110*	Deluxe		3.50	3.25	3.00

\* Available in Clear, Smoke and Indoor/Outdoor    ▲ Available in Clear only



CLEAR



S-17110

**DELUXE**  
Soft temple inserts,  
nonslip nosepiece.

# ULINE BULK SAFETY GLASSES

Ice Wraparound – Ultra popular glasses with guaranteed nonslip fit.

- Frameless, anti-scratch lens.



H-5053

ICE WRAPAROUND

Hawk Air™ – Economical, lightweight, wraparound lenses.

- No-pinch nosepiece. Anti-scratch lens.



H-6130

HAWK AIR™

ULINE FAVORITE

Meets ANSI Z87.1+

MODEL NO.	DESCRIPTION	LENS COLOR	QTY./ BOX	PRICE PER BOX		
				1	3	5+
H-5053	Ice Wraparound	Clear	24	\$58	\$56	\$54

Meets ANSI Z87.1+

MODEL NO.	DESCRIPTION	LENS COLOR	QTY./ BOX	PRICE PER BOX		
				1	3	5+
H-6130	Hawk Air™	Clear	24	\$40	\$38	\$36

# ULINE SAFETY GLASSES

Visitor Specs – Comfortable, low-cost safety glasses used for warehouse visitors.

- Fits with or without eyeglasses.



S-7022

VISITOR SPECS

Meets ANSI Z87.1+

MODEL NO.	DESCRIPTION	LENS COLOR	PRICE EACH (MIN. 10)		
			10	20	100+
S-7022	Visitor Specs	Clear	\$2.00	\$1.85	\$1.70

Optimus™ – Full frame wraparound style. Rubber temples and comfortable nosepiece.

- Anti-fog, anti-scratch lens.



S-19899

OPTIMUS™

Meets ANSI Z87.1+

MODEL NO.	DESCRIPTION	LENS COLOR	PRICE EACH (MIN. 6)		
			6	12	24+
S-19899	Optimus™	Clear or Yellow Mirror	\$6.50	\$6.25	\$6.00

# BULLDOG™ SAFETY GLASSES



S-24655

BULLDOG™

So lightweight and comfortable you won't even know they're on.

- Flexible, no-pinch design with an integrated nosepiece.
- Wraparound, anti-scratch polycarbonate lens.
- Provides 99.9% UV protection.

Meets ANSI Z87.1+

MODEL NO.	DESCRIPTION	LENS COLOR	PRICE EACH (MIN. 12)		
			12	24	48+
S-24655	Bulldog™	Clear	\$2.75	\$2.50	\$2.25



**Outlaw™** – Rugged look with protective side shields.

- Rubber earpiece for a secure fit. Anti-fog lens.



**Baja™** – Wraparound design provides maximum protection.

- Fully adjustable temples and anti-fog lens.



**Skyhawk™** – Smooth flowing, wraparound design.

- Soft, comfortable nosepiece. Anti-fog lens.



**Lynx™** – Floating lens design. Frame spreads to fit wider faces.

- Nonslip flexible nosepiece. Anti-fog lens.



**Raven™** – Sporty wraparound style.

- Fully adjustable temple length for comfortable fit. Anti-fog lens.



**Thunderbolt™** – Stylish, wraparound design with black rubber temple.

- Comfortable, soft nosepiece. Anti-fog, anti-scratch lens.



**Everest™** – Traditional styling with protective side shields.

- Fully adjustable temples and anti-fog lens.



**Polar-Ice™** – Polarized lenses reduce glare and brightness.

- Soft rubber temples and nosepiece. Anti-scratch lens.

Meets ANSI Z87.1+

MODEL NO.	DESCRIPTION	LENS COLOR	PRICE EACH (MIN. 6)		
			6	12	24+
S-11438	Outlaw™	Clear or Smoke	\$4.25	\$4.00	\$3.75
S-12451	Skyhawk™	Clear or Smoke	5.50	5.25	5.00
S-11439	Raven™	Clear	4.75	4.50	4.25
S-5685	Everest™	Clear	3.75	3.50	3.25

Meets ANSI Z87.1+

MODEL NO.	DESCRIPTION	LENS COLOR	PRICE EACH		
			6	12	24+
S-9638	Baja™	Clear	\$4.75	\$4.50	\$4.25
S-19257	Lynx™	Clear or Indoor/Outdoor	5.75	5.50	5.25
S-19258	Thunderbolt™	Clear or Smoke	6.50	6.25	6.00
S-19902	Polar-Ice™	Smoke or Silver Mirror	1/\$23 6+/\$21		



Slip-on side eye protection fits regular and safety eyewear.

- Durable and reusable.
- Clear PVC.

Meets ANSI Z87.1

MODEL NO.	DESCRIPTION	QTY./CTN.	PRICE PER PAIR (MIN. 6)	
			6	60+
S-16226	Deluxe	60 Pairs	\$3.35	\$2.95

## DELUXE SIDE SHIELDS

## SAFETY GLASSES DISPENSERS



Keep safety glasses easily accessible.

- Clear acrylic makes checking for refill easy.
- Wall mount or countertop use.
- H-3572 – Hinged lid protects against dust and dirt.

MODEL NO.	SIZE H x D x W	CAPACITY	PRICE EACH	
			1	3+
H-4157	14 x 6½ x 8"	14 Pairs	\$76	\$69
H-3572	13 x 8½ x 18"	32 Pairs	115	105

## CHUMS® EYEWEAR STRAP



All-cotton eyewear strap. Fits all standard safety glasses.

- Breakaway strap – S-18192.

MODEL NO.	DESCRIPTION	PRICE EACH (MIN. 6)	
		6	24+
S-11440	Adjustable	\$4.75	\$4.25
S-18192	Breakaway	5.25	4.75



# ULINE SAFETY GLASSES

FOGARMOR™ ANTI-FOG COATING/99.9% UV PROTECTION

FogArmor™ enhanced coating keeps lenses clear and fog-free.

Flash™ – Featherweight wraparound design.

- Soft gel nosepiece. Anti-scratch lens.

Redhawk™ – Sleek wraparound style.

- Comfortable nose grips. Anti-scratch lens.

Hawkeye™ – Anti-slip gel nosepiece.

- Ultra lightweight. Cushioned temples. Anti-scratch lens.

Jayhawk™ – Style meets safety. Sleek wraparound design.

- Flexible temples and comfortable nosepiece.



S-17944

FLASH™



S-14171

REDHAWK™



S-15373

HAWKEYE™



S-22188

JAYHAWK™

Meets ANSI Z87.1+

MODEL NO.	DESCRIPTION	LENS COLOR	PRICE EACH (MIN. 6)		
			6	12	24+
S-17944	Flash™	Clear or Indoor/Outdoor	\$5.50	\$5.25	\$5.00
S-14171	Redhawk™	Clear or Smoke	5.25	5.00	4.75

Meets ANSI Z87.1+

\* SPECIFY FRAME COLOR: Black or Lime

MODEL NO.	DESCRIPTION	LENS COLOR	PRICE EACH (MIN. 6)		
			6	12	24+
S-15373	Hawkeye™	Clear	\$5.25	\$5.00	\$4.75
S-22188*	Jayhawk™	Clear or Smoke	7.25	7.00	6.75

# UVEX SAFETY GLASSES

HYDROSHIELD™ ANTI-FOG COATING/99.9% UV PROTECTION

Protégé® – Floating lenses let frame open wider. Fits people with larger heads.

- Soft, comfortable nosepiece.



S-14214

PROTÉGÉ®

Seismic® – Removable foam seal conforms to face. Converts to goggles with adjustable headstrap.

- Anti-scratch lens.



S-19892

SEISMIC®

Genesis® – Sleek design with all the features: cushioned forehead and nosepiece.

- Adjustable temple length.



S-7896

GENESIS®

Livewire™ – Lightweight. Wide lens with snug-fitting foam seal.

- Converts to goggles with headstrap.



S-20722

LIVEWIRE™

Meets ANSI Z87.1+ and MIL-PRF-31013

MODEL NO.	DESCRIPTION	LENS COLOR	PRICE EACH (MIN. 5)		
			5	10	20+
S-14214	Protégé®	Clear	\$9.50	\$9.25	\$9.00
S-7896	Genesis®		14.00	13.00	12.00

Meets ANSI Z87.1+

MODEL NO.	DESCRIPTION	LENS COLOR	PRICE EACH (MIN. 2)		
			2	10	20+
S-19892	Seismic®	Clear	\$24	\$23	\$22
S-20722	Livewire™	Clear or Smoke	24	23	22

# LASER SAFETY GLASSES

Absolutely essential for industrial metal cutters and tool and die makers.

- Optimal protection from harmful laser lights.
- Comfortable, lightweight frame and cushioned nosepiece.

Meets ANSI Z87.1+ and Z136.1

MODEL NO.	DESCRIPTION	LENS COLOR	LASER TYPE	PRICE EACH	
				1	2+
S-24659	Laser	Green	CO2 & YAG	\$170	\$160

- Includes case, lanyard and microfiber cloth.



## 3M HEADGEAR/FACE SHIELDS



Protects face and eyes from flying splinters, chips and splashes.

- Recommended for facility sanitation and metal stamping.

**Headgear** – Easy-to-adjust ratchet headband.

**Face Shield** – Easy to change.



S-12572

Meets ANSI Z87.1+

MODEL NO.	DESCRIPTION	RECOMMENDED USE	SIZE/ THICKNESS	PRICE EACH (MIN. 2)	
				2	10+
S-12570	Polycarbonate	High Impact	9 x 14½	\$9.50	\$8.75
S-12571	Propionate	Chemical Splash	x .080"	13.50	12.75
S-12572	Headgear	Size Adjustable – Ratchet		22.00	20.00

## ULINE HEADGEAR/FACE SHIELDS



Lightweight, durable face and eye protection from flying debris.

- Recommended for metal fabrication and landscaping.

**Headgear** – Easy-to-adjust ratchet.

**Face Shield** – Swaps out easily.



S-24620

Meets ANSI Z87.1+

MODEL NO.	DESCRIPTION	RECOMMENDED USE	SIZE/ THICKNESS	PRICE EACH (MIN. 2)	
				2	10+
S-24618	Polycarbonate	High Impact	8 x 16 x .080"	\$8	\$7
S-24619	Anti-Fog			15	13
S-24620	Headgear	Size Adjustable – Ratchet		11	10

## UVEX BIONIC® FACE SHIELD



Full-frame design totally protects head and neck from chemical splashes and flying debris.

- Recommended for machinists and auto body shops.
- Lightweight, ratcheting headgear.
- Anti-fog, anti-scratch polycarbonate face shield.
- Contoured shape provides excellent visibility.
- Ultra-clear lens.

Meets ANSI Z87.1+

MODEL NO.	DESCRIPTION	RECOMMENDED USE	SIZE/ THICKNESS	PRICE EACH	
				1	3+
S-20755	Polycarbonate	High Impact	8½ x 18 x .040"	\$62	\$59

## BLUE LIGHT SAFETY GLASSES New



Reduce eyestrain caused by computers and tablets.

- Recommended for dock coordinators and velocity managers.
- Filters out blue light and blocks harmful UV rays. No yellow tint.
- Nonslip rubber nosepiece and temples. FogArmor™ anti-fog coating.

Meets ANSI Z87.1+

MODEL NO.	DESCRIPTION	LENS COLOR	PRICE EACH (MIN. 2)		
			2	6	12+
S-25059	Safety Glasses	Clear	\$18	\$17	\$16

## DISPOSABLE FACE SHIELD

Block spray and splatter from your eyes, nose and mouth.

- Recommended for visitors or short-term use. Flexible poly lens.
- Added personal protection over glasses and masks.
- Foam-lined headband with elastic strap for all-day comfort.



MODEL NO.	DESCRIPTION	RECOMMENDED USE	SIZE/ THICKNESS	QTY./ CTN.	PRICE/CARTON	
					1	4+
S-24607	Deluxe	Medium Splash	8½ x 13 x .013"	25	\$65	\$60

## ULINE LENS CLEANING SUPPLIES



Clean and protect your face shields, goggles and glasses.

**Pop-Up Dispenser** – Easy access. Pull out towelettes in one motion.

**Cleaning Station** – Includes cleaning solution and dry wipes. Wall mount or tabletop use.



MODEL NO.	DESCRIPTION	QTY./ CAN	PRICE PER CAN (MIN. 2)		
			2	5	10+
S-18421	Pop-Up Dispenser	100	\$10	\$9	\$8

MODEL NO.	DESCRIPTION	QTY./ BOX	PRICE EACH (MIN. 2)		
			2	5	10+
S-18422	Cleaning Station	600	\$10	\$9	\$8

# SAFETY GOGGLES

ANTI-FOG



**Stealth®** – Protect eyes from chemical splash. Soft, comfortable plastic seal. Indirect vent.

- HydroShield™ coating guarantees fog-free lenses.



**Flex Seal®** – Ultra-flexible silicone seal conforms to face.

- Protects against impact and chemical splash. Indirect vent.



**OTG Stealth®** – Soft, flexible face seal. Fog-free lenses.

- Fits over most prescription glasses. Indirect vent.



**Economy** – Vents reduce fogging for extended wear.

- Fits over most prescription glasses. Indirect vent.
- Screened top and bottom ports circulate air.

**Cruze™** – Ultra-soft, flexible seal conforms to face.

- Protects against impact and chemical splash.
- FogArmor™ coating.



MODEL NO.	DESCRIPTION	LENS COLOR	Meets ANSI Z87.1+		
			PRICE EACH (MIN. 2)		
			2	10	20+
S-18416	Stealth®	Clear	\$22	\$21	\$19
S-20752	Flex Seal®		23	22	21
S-20753	OTG Stealth®		26	25	24

MODEL NO.	DESCRIPTION	LENS COLOR	Meets ANSI Z87.1+		
			PRICE EACH		
			2	10	20+
S-16223	Economy	Clear	N/A	\$2.25	\$2.05
S-22179	Cruze™		\$10.00	9.50	9.00

# 3M SAFETY GOGGLES

Low-profile design fits comfortably underneath respirators and face shields.

MODEL NO.	DESCRIPTION	LENS COLOR	Meets ANSI Z87.1+		
			PRICE EACH (MIN. 2)		
			2	10	20+
S-24392	GoggleGear™	Clear or Smoke	\$25	\$24	\$23

- Protects against impact and chemical splash. Indirect vent.
- 99.9% UV protection.

## SCOTCHGARD™ ANTI-FOG COATING



# SAFETY GLASS WIPES

Premoistened wipes leave no residue on lens.

- Nonabrasive. Anti-static.

**Uline** – Quality you can trust.

**Uline Anti-Fog** – Protection from heat and humidity.

**PDI** – Smaller size cleans nose pads well.

**Bausch & Lomb** – #1 selling brand. Unique formula.



MODEL NO.	DESCRIPTION	SHEET SIZE	QTY./BOX	PRICE PER BOX		
				1	5	10+
S-19310	Uline	5 x 8"	120	\$10	\$9	\$8
S-24004	Uline Anti-Fog			20	19	18

MODEL NO.	DESCRIPTION	SHEET SIZE	QTY./BOX	PRICE PER BOX		
				1	5	10+
S-13395	PDI	5 x 6"	120	\$13	\$12	\$11
S-20719	Bausch & Lomb	5 x 8"	100	19	18	17



# REUSABLE EARPLUGS



**3M E.A.R. Push-Ins™** – No rolling. Handle allows quick, clean insertion and removal.

**AirSoft®** – Unique fins provide protection and comfort. Easy to insert, remove and reuse.

**ULINE** – Provides greater comfort for all-day wear. Tapered design for easy insertion and removal.

MODEL NO.	DESCRIPTION	NRR	PAIRS/BOX	PRICE PER BOX		
				1	3	5+
S-18078	3M Push-Ins™ Earplugs	28	100	\$54	\$53	\$52
S-18079	3M Push-Ins™ Corded Earplugs			86	83	81
S-13518	AirSoft® Earplugs	27	100	130	127	124
S-13519	AirSoft® Corded Earplugs			147	143	139
S-19873	Uline Earplugs	26	100	74	72	70
S-19874	Uline Corded Earplugs			97	94	91

## EARPLUG DISPENSERS



**ONE TOUCH™ PRO**  
Refillable station.

- Wall mount or tabletop use.
- Uses E.A.R. Yellow Neons™ or Classic™.



**MOLDEX®**  
Disposable station.

- Wall-mountable.
- Pura-Fit® or SparkPlugs® earplugs included.



**HOWARD LEIGHT®**  
Reusable station.

- Wall mount or tabletop.
- Uses Laser Lite® or Max® earplugs.



Mounting hardware included for easy installation

MODEL NO.	DESCRIPTION	NRR	PAIRS/BOX	PRICE PER BOX	
				1	4+
S-12514	3M E.A.R. Yellow Neons™ Refill	33	500	\$89	\$85
S-18098	3M E.A.R. Classic™ Refill	29	500	124	118
H-5337*	3M E.A.R. Dispenser Base	N/A	N/A	75	71
S-9868S	Pura-Fit® Small	33	250	63	61
S-9868L	Pura-Fit® Large		500	118	114

\* Earplugs sold separately

MODEL NO.	DESCRIPTION	NRR	PAIRS/BOX	PRICE PER BOX	
				1	4+
S-18105	SparkPlugs® Small	33	250	\$56	\$54
S-18106	SparkPlugs® Large		500	106	102
S-20737	Laser Lite® Refill	32	500	80	77
S-20738	Max® Refill	33	500	91	87
H-5103*	Leight® Source Dispenser	N/A	N/A	265	255

\* Earplugs sold separately

## ULINE DISPENSER



Reusable station provides quick access to earplugs.

- Twist knob to dispense.
- Set on table or mount to wall.
- Uses Uline Bullet Earplugs, sold separately.

Mounting hardware included

MODEL NO.	DESC.	NRR	PAIRS/BAG	PRICE/BAG	
				1	4+
S-24617	Bullet Refill	32	500	\$55	\$52
H-9853	Dispenser	N/A	N/A	35	32

## EARMUFFS



**ULINE**

S-20706

Premium protection at an affordable price.

- Deluxe padded cups block out harmful noise.
- Hi-Vis – Be seen on oil rigs and construction sites.

SPECIFY COLOR: Black or Hi-Vis Lime

MODEL NO.	NRR	PRICE EACH	
		1	3+
S-20706	28	\$17	\$16



S-23169

S-20449

**3M PELTOR™**

Protects against power tools and landscaping equipment.

- Large padded cushions feature combined liquid and foam filling for good seal and ultimate comfort.

**S-23169 3M X4** – Slim design. Insulated wire headband.

**S-20449 3M Optime™ 105** – Ultra soft. Double-shell earmuff.

MODEL NO.	DESCRIPTION	NRR	PRICE EACH	
			1	3+
S-23169	3M X4	27	\$47	\$45
S-20449	3M Optime™ 105	30	45	44

# DISPOSABLE EARPLUGS



## HOWARD LEIGHT®

Max Lite® – Recommended for long-term comfort and those with smaller ear canals.

Max® – Highest rated disposable earplug in the U.S.

Laser Lite® – Self-adjusting foam fits virtually any ear canal. Contoured for easy handling.

MODEL NO.	DESCRIPTION	NRR	PAIRS/BOX	PRICE PER BOX		
				1	5	10+
S-7904	Max Lite® Earplugs	30	200	<b>\$33 per box any qty.</b>		
S-7905	Max Lite® Corded Earplugs			\$34	\$33	\$32
S-7902	Max® Earplugs	33	200	40	39	38
S-7903	Max® Corded Earplugs			38	37	36
S-17097	Laser Lite® Earplugs	32	200	36	35	34
S-17098	Laser Lite® Corded Earplugs			35	34	33



## 3M E.A.R. CLASSIC™

Provides a better seal.

- Barrel shape for easy insertion.
- Sweat resistant.
- PVC foam expands for a custom fit.



## ULINE BULLET

Super soft foam.

- Tapered bullet shape.
- Easy-to-roll design.
- Comfortable snug fit.
- Easily seen for compliance checks.

MODEL NO.	DESCRIPTION	NRR	PAIRS/BOX	PRICE PER BOX		
				1	5	10+
S-7028	3M Classic™ Earplugs	29	200	\$47	\$45	\$43
S-7029	3M Classic™ Corded Earplugs			89	87	84

MODEL NO.	DESCRIPTION	NRR	PAIRS/BOX	PRICE PER BOX		
				1	5	10+
S-17902	Uline Earplugs	32	200	<b>\$23 per box any qty.</b>		
S-17903	Uline Corded Earplugs			\$49	\$47	\$45



## MOLDEX® SPARKPLUGS®

- Extra soft.
- Tapered design.
- Smooth surface. 100% PVC-free.



## ULINE BELL EARPLUGS

Wide base seals out dirt and debris.

- Contoured bell shape for easy insertion.
- Expands for secure, comfortable fit.

MODEL NO.	DESCRIPTION	NRR	PAIRS/BOX	PRICE PER BOX		
				1	5	10+
S-15344	SparkPlugs® Earplugs	33	200	\$42	\$41	\$40
S-15345	SparkPlugs® Corded Earplugs			43	42	41

MODEL NO.	DESCRIPTION	NRR	PAIRS/BOX	PRICE PER BOX		
				1	5	10+
S-22140	Uline Bell Earplugs	32	200	\$28	\$27	\$26
S-22141	Uline Bell Corded Earplugs			26	25	24



## HOWARD LEIGHT® METAL DETECTABLE

Recommended for food prep and pharmaceutical processing.

- Metal detectors sense enclosed ball bearing.
- Corded for repeated use.



## ACRYLIC DISPENSERS

Keep earplugs accessible.

- Hinged lid protects against dust.
- Set on a table or mount on wall.



MODEL NO.	DESCRIPTION	NRR	PAIRS/BOX	PRICE PER BOX		
				1	5	10+
S-17016	Laser Trak® Corded Earplugs	32	100	\$52	\$50	\$48

MODEL NO.	SIZE W x D x H	CAPACITY	WT. (LBS.)	PRICE EACH		
				1	3	5+
H-4181	6 x 8 x 13"	250 Pairs	5	\$87	\$85	\$83
H-3400	12 x 8 x 13"	500 Pairs	8	105	103	101

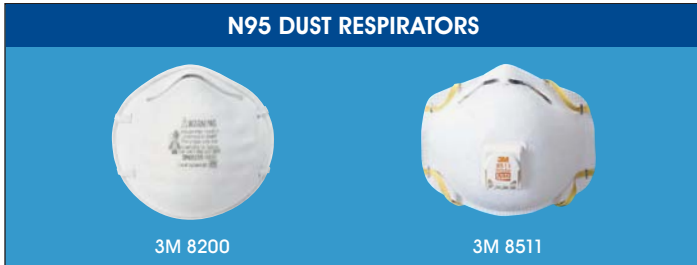

**3M 8200** – Cost-effective respirator for sweeping, sanding. Adjustable nose clip for secure, custom fit. N95.

**3M 8511** – Same features as Uline with an M-shape nose clip for better comfort and fit. N95.

MODEL NO.	DESCRIPTION	QTY./ CTN.	PRICE PER CARTON		
			1	3	10+
S-17009	3M 8200 Dust Respirator	20	\$21	\$20	\$19
S-6779	3M 8511 Dust Respirator w/ Valve	10	32	31	30



**3M 8210** – Lightweight, comfortable protection against dust, dirt and oil-free air. Nose clip for secure, custom fit. N95.

**3M 8110S** – Adjustable nose clip for a custom fit on smaller faces. N95.

MODEL NO.	DESCRIPTION	QTY./ CTN.	PRICE PER CARTON		
			1	3	10+
S-5688	3M 8210 Dust Respirator	20	\$23 any ctn. qty.		
S-19188	3M 8110S Dust Respirator	20	\$32	\$31	\$30



**3M 9211+** – Folds flat to fit in your pocket or toolbox. Exhalation valve for cool, dry breathing. N95.

**3M 9105** – V-shaped pleats expand and flex for easy breathing and talking. Nose clip for secure fit. N95.

MODEL NO.	DESCRIPTION	QTY./ CTN.	PRICE PER CARTON		
			1	3	10+
S-17012	3M 9211+ Dust Respirator w/ Valve	10	\$31	\$30	\$29
S-19729	3M 9105 Dust Respirator	50	45	43	41



**3M 8210V** – Basic and lightweight. Protects against dust, dirt and oil-free air. N95.

**3M 8214 Organic Respirator** – Filters metal fumes and odors during welding operations. Exhale valve. N95.

MODEL NO.	DESCRIPTION	QTY./ CTN.	PRICE PER CARTON		
			1	3	10+
S-20627	3M 8210V Dust Respirator w/ Valve	10	N/A	\$20	\$19
S-17015	3M 8214 Organic Respirator	10	\$123	120	116



**3M 8515 Welding Respirator** – Use during welding operations when fumes are present. Exhalation valve. Flame resistant. N95.

**3M 8233 Particulate Respirator** – Filters toxins from oil-free air. Exhale valve for cool, dry breathing. N100.

**3M 8293 Industrial Respirator** – Highest rated protection. Comfortable face seal with Cool Flow™ exhalation valve. P100.

MODEL NO.	DESCRIPTION	QTY./ CTN.	PRICE PER CARTON		
			1	3	10+
S-17014	3M 8515 Welding Respirator	10	\$47	\$46	\$45
S-17013	3M 8233 Particulate Respirator	1	N/A	15	14
S-19189	3M 8293 Respirator w/ Valve	1	N/A	17	16



**3M 8271 Oil-Proof Respirator** – Works in dusty, oil-laden air. Exhale valve for cool, dry wear. P95.

**3M 8577 Vapor Respirator** – Oil-proof. Carbon layer filters out nuisance-level organic vapors. Valve for cool, dry breathing. P95.

**3M 8576 Gas Respirator** – Oil-proof. Protects against acid gases, including sulfur dioxide and chlorine. Exhalation valve. P95.

MODEL NO.	DESCRIPTION	QTY./ CTN.	PRICE PER CARTON		
			1	3	10+
S-7878	3M 8271 Oil-Proof Respirator w/ Valve	10	\$57	\$56	\$55
S-12526	3M 8577 Vapor Respirator w/ Valve	10	77	75	72
S-19737	3M 8576 Gas Respirator w/ Valve	10	77	75	72



# ULINE RESPIRATORS

All respirators meet NIOSH standards.



**Uline** – Economical protection against dust, dirt and oil-free air. Adjustable nose clip for snug, comfortable fit. N95.

**Uline Deluxe** – Soft foam cushioning with comfortable inner layer. Pre-shaped nose bridge. N95.

**Uline with Valve** – Exhalation valve keeps your face cool and dry. Adjustable nose clip. Comfortable all-day wear. N95.

**Uline Deluxe with Valve** – Same features as Uline Deluxe with exhalation valve for cool, dry comfort. N95.

MODEL NO.	DESCRIPTION	QTY./ CTN.	PRICE PER CARTON		
			1	3	12+
S-9632	Standard Respirator	20	\$15	\$14	\$13
S-10479	Standard Respirator w/ Valve	10	17	16	15

MODEL NO.	DESCRIPTION	QTY./ CTN.	PRICE PER CARTON		
			1	3	12+
S-19252	Deluxe Respirator	20	\$18	\$17	\$16
S-19253	Deluxe Respirator w/ Valve	10	\$17 any ctn. qty.		

## MASK DISPENSER

Provide masks to customers and guests.

- For storefronts and office lobbies.
- Crack-resistant acrylic.
- Hinged lid protects against dust.
- Place on table or wall mount.



MODEL NO.	SIZE H x W x D	MASK CAPACITY	PRICE EACH	
			1	3+
H-9868	5 x 9 x 5"	65	\$65	\$60

## ULINE FACE MASKS



**Disposable Mask** – 3-ply design. Standard earloop and adjustable nosepiece.

**Surgical Masks** – Soft, comfortable. Fluid resistant. FDA compliant.

- **S-22137** – Foam nose strip for superior, all-day comfort.

\* SPECIFY COLOR: Black or Blue

MODEL NO.	DESCRIPTION	QTY./ CTN.	PRICE PER CARTON		
			1	6	12+
S-24023*	Disposable Face Mask	50	\$7	\$6	\$5
S-10478	Surgical Mask	50	8	7	6
S-22137	Deluxe Surgical Mask		10	9	8

## MOLDEX® RESPIRATORS



**Moldex® 2200** – Soft, comfortable foam nose cushion. Employees appreciate. N95.

**Moldex® 2700** – HandyStrap® allows mask to hang around neck when not in use. Exhale valve. N95.

**Moldex® 2300** – Soft foam nose cushioning for all-day comfort. Excellent for hot, humid conditions. N95.

**Moldex® 2400** – Maximum comfort with added protection against nuisance-level organic vapors. Exhale valve. N95.

MODEL NO.	DESCRIPTION	QTY./ CTN.	PRICE PER CARTON		
			1	3	10+
S-15312	2200 Dust Respirator	20	\$31	\$30	\$29
S-15313	2300 Dust Respirator w/ Valve	10	41	40	38

MODEL NO.	DESCRIPTION	QTY./ CTN.	PRICE PER CARTON		
			1	3	10+
S-20721	2700 Respirator w/ Valve	10	\$51	\$49	\$47
S-19256	2400 Respirator w/ Valve		69	67	64

# 3M RESPIRATOR ACCESSORIES

COMPONENTS SOLD SEPARATELY



## CARTRIDGE/FILTER COMBOS

- Cartridge and filter in one.
- Permanent P100 filter adds particulate protection.

## CARTRIDGES

- Replaceable cartridges attach to both half and full-face respirators.

## PRE-FILTERS

- For use with cartridges only. Adds particulate protection.

## FILTER ADAPTERS

- Connect filters to cartridges.

## PARTICULATE FILTERS

- Snap-on filters provide additional protection from dust and particles.

MODEL NO.	3M NO.	DESCRIPTION	QTY./PKG.	PRICE/PKG.	
				1	5+

### CARTRIDGE/FILTER COMBOS

MODEL NO.	3M NO.	DESCRIPTION	QTY./PKG.	PRICE/PKG. 1	PRICE/PKG. 5+
S-19184	3M 60921	Organic Vapor/P100		\$38	\$35
S-20402	3M 60922	Acid Gas/P100		41	39
S-19185	3M 60923	Organic Vapor/Acid Gas/P100		39	36
S-20403	3M 60924	Ammonia/Methylamine/P100	2	44	42
S-20004	3M 60925	Formaldehyde/Organic Vapor/P100		45	43
S-19186	3M 60926	Multiple Gases/Vapor/P100		41	39
S-20346	3M 60928	Organic Vapor/Acid Gas/P100		59	57

### CARTRIDGES

MODEL NO.	3M NO.	DESCRIPTION	QTY./PKG.	PRICE/PKG. 1	PRICE/PKG. 5+
S-9747	3M 6001	Organic Vapor		\$20	\$19
S-20323	3M 6002	Acid Gas		22	21
S-9748	3M 6003	Organic Vapor/Acid Gas		21	20
S-20324	3M 6004	Ammonia/Methylamine	2	24	23
S-20005	3M 6005	Formaldehyde/Organic Vapor		24	23
S-12527	3M 6006	Multiple Gases		21	20

MODEL NO.	3M NO.	DESCRIPTION	QTY./PKG.	PRICE/PKG.	
				1	5+

### PRE-FILTERS

MODEL NO.	3M NO.	DESCRIPTION	QTY./PKG.	PRICE/PKG. 1	PRICE/PKG. 5+
S-9749	3M 5N11	N95 Pre-Filter		\$25	\$24
S-19187	3M 5P71	P95 Pre-Filter	10	31	30

### FILTER ADAPTERS

MODEL NO.	3M NO.	DESCRIPTION	QTY./PKG.	PRICE/PKG. 1	PRICE/PKG. 5+
S-9752	3M 501	Pre-Filter Retainer	20	\$65	\$64
S-17122	3M 502	Particulate Filter Adapter		84	82

### PARTICULATE FILTERS

MODEL NO.	3M NO.	DESCRIPTION	QTY./PKG.	PRICE/PKG. 1	PRICE/PKG. 5+
S-17119	3M 2071	P95		\$9	\$8
S-21248	3M 2078	Nuisance-Level Organic Vapor/Acid Gas P95		14	13
S-17120	3M 2091	P100	2	13	12
S-17121	3M 2097	Nuisance-Level Organic Vapor/P100		17	16
S-21249	3M 2291	Advanced/P100		14	13
S-20007	3M 7093	P100 Hard Shell		85	83
S-21100	3M 7093C	Hydrogen Fluoride/P100	12	140	136



## 3M FIT TESTS

Meets OSHA's testing requirements for respirator performance.

- Reliable pass/fail results for 200 tests.
- For use with 3M 5000, 6000, 7000 and 3M Ultimate FX Respirators.

Kits Include: Hood, collar assembly, 2 nebulizers, 2 sets of replacement nebulizer inserts, sensitivity and fit test solutions.

MODEL NO.	3M NO.	DESCRIPTION	PRICE EACH	
			1	2+
S-20378	3M FT-10 Fit Test	Sweet	\$455	\$435
S-20379	3M FT-30 Fit Test	Bitter		

# 3M REUSABLE RESPIRATORS

## 3M 6000

MODEL NO.	3M NO.	DESCRIPTION	SIZE	QTY./ BOX	PRICE EACH	
					1	6+
H-2802	3M 6100	Half-Face	Small	1	\$21	\$20
H-1081	3M 6200		Medium			
H-1111	3M 6300		Large			
H-2803	3M 6700	Full-Face	Small	1	240	230
H-1471	3M 6800		Medium			
H-1472	3M 6900		Large			

## 3M 6000

Breathe clearly when grinding, welding or painting.

- Lightweight, comfortable.

**Full-Face** – Exhale valve provides cool, long-wearing comfort. Excellent visibility. Soft cushioned face seal.



3M 6000 FULL-FACE

## 3M ULTIMATE FX FF-400

MODEL NO.	3M NO.	DESCRIPTION	SIZE	QTY./ BOX	PRICE EACH	
					1	4+
H-4726	FF-401	Full-Face	Small	1	\$335	\$325
H-4727	FF-402		Medium			
H-4728	FF-403		Large			

## 3M ULTIMATE FX FF-400

Lightweight comfort and protection from industrial paints, stains and chemicals.

- Soft silicone seal and 6-point elastic harness provide a premium fit.
- Scotchgard™ coated wide-view lens.
- Excellent visibility and easy cleanup.



3M FF-400 FULL-FACE

## 3M 7000

MODEL NO.	3M NO.	DESCRIPTION	SIZE	QTY./ BOX	PRICE EACH	
					1	6+
H-3392	3M 7501	Half-Face	Small	1	\$47	\$46
H-3393	3M 7502		Medium			
H-3394	3M 7503		Large			
H-3395	3M 7800S-S	Full-Face	Small	1	680	660
H-3396	3M 7800S-M		Medium			
H-3397	3M 7800S-L		Large			

## 3M 7000

Protection in chemical and biohazard environments.

- Durable silicone seal for all-day wear.

**Half-Face** – Exhale valve for fog-free work.

**Full-Face** – Clear communication with speaking diaphragm.



3M 7000 FULL-FACE

# 3M 6500 HALF-FACE RESPIRATOR

MODEL NO.	3M NO.	DESCRIPTION	SIZE	QTY./ BOX	PRICE EACH	
					1	6+
H-4986	3M 6502	Half-Face	Medium	1	\$30	\$29
H-4987	3M 6503		Large			

Protects in extreme conditions for demolition and sanding.

- Silicone face seal provides comfort.
- Cool Flow™ valve reduces heat and moisture for easier breathing.



3M 6500 HALF-FACE

# 3M RESPIRATOR FACESHIELD COVERS



Optional protection for 3M 6000 and 3M FF-400 full-face lenses.

- Disposable cover attaches easily to faceplate.

**Clear** – Crystal clear for maximum visibility.

**Tinted** – Shields eyes from bright lights and sunlight.



S-22979

MODEL NO.	DESC.	3M NO.	FITS	QTY./ PKG.	PRICE/PKG.	
					1	6+
S-16201	Clear	3M 6885	3M 6700, 3M 6800, 3M 6900	25	\$73	\$69
S-21403		3M FF-400-15	3M FF-401, 3M FF-402, 3M FF-403			
S-22979	Tinted	3M 6886	3M 6700, 3M 6800, 3M 6900	25	195	185



## 3M VERSAFLO™ PAPR TR-600



Ready-to-Use Kit Includes: Hard hat assembly top, motor blower, battery, breathing tube, high durability belt, HE/OV/AG filter cartridge, filter cover, battery charger and high temperature breathing tube cover.

Your own powered air filtration system provides respiratory, head, eye and face protection.

- For demolition, grinding, metal casting and harsh environments.
- Battery-powered fan draws contaminated air through filter to deliver fresh, clean air to wearer.
- System alerts workers of poor air flow or low battery.

### PAPR KIT

MODEL NO.	3M NO.	DESCRIPTION	PRICE EACH	
			1	2+
H-7971	TR-600-HIK	Versaflo™ Heavy Industry PAPR Kit	\$3,000	\$2,900

### ADDITIONAL CARTRIDGES

MODEL NO.	3M NO.	DESCRIPTION	1	5+
			PRICE EACH	PRICE EACH
S-23043	TR-6510N	Organic Vapor/HEPA	\$170	\$160
S-23044	TR-6530N	Organic Vapor/Acid Gas/HEPA		

## 3M PAINT PROJECT REUSABLE RESPIRATORS



ALL-IN-ONE

For painting, staining, landscaping and pesticide applications.

- Balanced design for comfortable fit.
- Provides 95% filtering of aerosols and organic vapors.
- Includes 3M 6000 half-face respirator, 2 organic vapor cartridges, 4 P95 pre-filters and 2 retainers.
- Refill Kit – Contains replacement cartridges and filters.



REFILL KIT

MODEL NO.	3M NO.	DESCRIPTION	SIZE	QTY./ BOX	PRICE EACH	
					1	4+
H-6021	6211PA1	Half-Face Organic Vapor/ P95	Medium	1	\$51	\$49
H-6022	6311PA1	Half-Face Organic Vapor/ P95	Large			
S-21394	6023PA1	Refill Kit	N/A		29	28

## 3M DISPOSABLE RESPIRATORS

### 3M 5000

Lightweight and comfortable.

**Organic Vapor** – Used for petrochemicals, chemical manufacturing, construction.

**Organic Vapor/P95** – Use in paint spraying, pesticides and agriculture.



3M 5000 HALF-FACE

MODEL NO.	3M NO.	DESCRIPTION	SIZE	QTY./ BOX	PRICE EACH	
					1	6+
H-3383	3M 5101	Half-Face Organic Vapor	Small	1	\$30	\$29
H-3384	3M 5201		Medium			
H-3385	3M 5301		Large			
H-3389	3M 51P71	Half-Face Organic Vapor/ P95	Small	1	40	38
H-3390	3M 52P71		Medium			
H-3391	3M 53P71		Large			

## RZ POLLUTION MASKS

Innovative mesh design. Beyond comfortable and cool.

- Easy to wear all day for construction, agriculture and demolition.
- Filters up to 99.9% of dust, dirt and air particles.
- Includes mask, 2 carbon filters and storage bag.



M2 MESH

MODEL NO.	DESCRIPTION	SIZE	QTY./ BOX	PRICE PER BOX	
				1	3+
H-7968	M2 Mesh Mask	L, XL	1	\$40	\$38
S-23042	Replacement Carbon Filter		3	11	10

## 3M VIRTUA™ CCS SAFETY GLASSES

Use a leaf blower or chainsaw all day long.

- Soft foam lining limits exposure to dust and debris.
- Anti-fog lens. 99.9% UV protection.
- Optional earplugs complete the package.



Meets ANSI Z87.1+

MODEL NO.	DESCRIPTION	LENS COLOR	QTY./ CTN.	PRICE EACH		
				3	10	20+
S-21545	Virtua™ CCS	Clear	20	\$13.25	\$12.75	\$12.25
S-17903	Uline Corded Earplugs		200 pr.	\$49 ctn. 5+/\$47 ctn.		



### CARTRIDGE/FILTER COMBOS

- Cartridge and filter in one.
- Permanent P100 filter adds particulate protection.

### CARTRIDGES

- Replaceable cartridges attach easily to faceplate.

MODEL NO.	NORTH® NO.	DESCRIPTION	QTY./PKG.	PRICE/PKG.	
				1	5+

#### CARTRIDGE/FILTER COMBOS

MODEL NO.	NORTH® NO.	DESCRIPTION	QTY./PKG.	PRICE/PKG. 1	PRICE/PKG. 5+
S-21486	7581P100L	Organic Vapor/P100	2	\$33	\$32
S-22227	7583P100L	Organic Vapor/Acid Gas/P100		33	32
S-21487	75SCP100L	Multiple Gases/Vapor/P100		33	32

#### CARTRIDGES

MODEL NO.	NORTH® NO.	DESCRIPTION	QTY./PKG.	PRICE/PKG. 1	PRICE/PKG. 5+
S-21482	N75001L	Organic Vapor	2	\$18	\$17
S-22228	N75003L	Organic Vapor/Acid Gas		18	17
S-21483	75SCL	Multiple Gases/Vapor		19	18

### PRE-FILTER

- For use with cartridges only. Adds particulate protection.

### FILTER ADAPTERS

- Connect filters to cartridges.

### PARTICULATE FILTERS

- Screw-on filters provide protection from particles.

MODEL NO.	NORTH® NO.	DESCRIPTION	QTY./PKG.	PRICE/PKG.	
				1	5+

#### PRE-FILTER

S-21484	7506N95	N95 Pre-Filter	10	\$17	\$16
---------	---------	----------------	----	------	------

#### FILTER ADAPTERS

S-21485	N750036	Pre-Filter Retainer	2	\$6	\$5
S-22229	N750035	Particulate Filter Adapter		19	18

#### PARTICULATE FILTERS

S-21488	7580P100	P100 Hard Shell	2	\$13	\$11
S-22230	75FFP100NL	Nuisance Level Organic Vapor		15	14



H-6105

## NORTH® REUSABLE RESPIRATORS

### 5000 SERIES

Work safely when removing mold and lead.

- Comfortable, lightweight design.
- Full-Face – Wide 200° field of vision.

### 7000 SERIES

Complete protection for asbestos abatement and sandblasting.

- Soft, ultra-comfortable silicone seal.
- Full-Face – Wide 200° field of vision. Speech diaphragm for clear communication.



H-6927

#### 5000 SERIES

\* Min. 2

MODEL NO.	NORTH® NO.	DESCRIPTION	SIZE	QTY./BOX	PRICE EACH	
					1	6+
H-6106*	550030M	Half-Face	Medium	1	\$19	\$18
H-6107*	550030L		Large			
H-6105	54001	Full-Face	M/L	1	173	168

#### 7000 SERIES

MODEL NO.	NORTH® NO.	DESCRIPTION	SIZE	QTY./BOX	PRICE EACH	
					1	6+
H-6925	770030M	Half-Face	Medium	1	\$39	\$38
H-6926	770030L		Large			
H-6927	760008A	Full-Face	M/L	1	320	305

## CLEANING WIPES

Clean reusable respirators between uses. Wipe away dust, dirt and sweat. Alcohol-free.

MODEL NO.	DESCRIPTION	SIZE	QTY./BOX	PRICE PER BOX	
				1	5+
S-21592	Uline	8 x 11"	100	\$29	\$27
S-19288	3M 504	8 x 10"		77	74

- Pre-moistened. Individually packaged.
- Safely cleans other reusable personal protective equipment.





## 3M HARNESS

COMFORT FIT



Slips on fast and easy. One piece, tangle-free design.

- Cushioned, nonslip shoulder and leg padding absorbs shock.
- Breathable lining draws away moisture to keep workers dry and comfortable.
- Quick connect seatbelt-style buckles are fast, efficient and completely secure.
- Choose your size: M (170-240 lbs.), L (240-300 lbs.), XL (300-340 lbs.) or 2XL (340-400 lbs.).

DBI-SALA®

Meets ANSI Z359.1

MODEL NO.	DESCRIPTION	SIZE	WEIGHT CAPACITY	PRICE EACH		
				1	3	5+
H-6928	ExoFit™	M, L, XL, 2XL	420 lbs.	\$389	\$385	\$379

Use with Retractable or Shock-Absorbing Lanyards.



## MILLER® HARNESS

CONFINED SPACE



Specially designed for confined space and climbing applications.

- Front and back D-rings for being lowered into tight spaces such as manholes, sewers and wells.
- Tongue buckles provide snug, secure connection.
- Comfortable and lightweight fall protection.

Meets ANSI Z359.1

MODEL NO.	DESCRIPTION	SIZE	WEIGHT CAPACITY	PRICE EACH		
				1	3	5+
H-9576	Confined Space	Universal	420 lbs.	\$120	\$115	\$110

Use with Retractable or Shock-Absorbing Lanyards.



## MILLER® TWIN TURBO™ LANYARD

Continuous fall protection. Allows 100% tie-off at all times.

- Move safely on catwalks, platforms and scaffolding.
- High-impact nylon housing. Easy-to-use steel rebar hooks.
- Built-in swivel prevents lifelines from twisting.

RETRACTABLE

Meets ANSI Z359

MODEL NO.	DESCRIPTION	LENGTH (FT.)	MAX. LOAD (LBS.)	WT. (LBS.)	PRICE EACH		
					1	3	5+
H-7962	Rebar Hook	6	400	7	\$545	\$535	\$525

### FALL PROTECTION

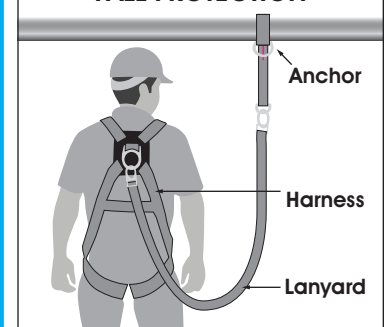

## LIFTING GLOVES

**Leather Padded** – Protect your hands from cuts. Comfortable leather padded palms.

**Leather Padded w/ Wrist Support** – Provides added support for repetitive heavy warehouse lifting.

**Wrap Around Wrist Support** – Ease pain and discomfort of wrist problems from lifting and warehouse work. Ambidextrous.



S-3816



S-9877

MODEL NO.	DESCRIPTION	SIZE	PRICE/PAIR (MIN. 2 PAIRS)		
			2	6	12+
S-2717	Leather Padded	S, M, L, XL	\$15	\$14	\$13
S-3816	Leather Pad. w/ Wrist Support	S, M, L, XL	19	18	17
S-9877*	Wrap Around Wrist Support	One	\$10 ea.	\$9 ea.	\$8 ea.

\* Price each

S-2717



# MILLER® LANYARDS

## SHOCK-ABSORBING



MANYARD™ I

MANYARD™ II

Simple and practical. Prevents injury in the event of a fall.

- For work heights over 18½ ft.
- 310 lb. capacity.

**Manyard™ I** – The original and still the industry leader. Unsurpassed safety and comfort.

**Manyard™ II** – Contracts to 4' to prevent tripping.

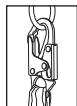

### SNAP HOOK

Attaches to harnesses and anchor points.

Meets ANSI Z359.1

MODEL NO.	DESCRIPTION	LENGTH (FT.)	MAX. LOAD (LBS.)	PRICE EACH		
				1	3	5+
H-858	Manyard™ I	6	310	\$140 each any qty.		
H-5128	Manyard™ II			\$165	\$160	\$155

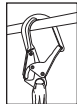

### REBAR HOOK

Connects directly to pipes or scaffolding.

Meets ANSI Z359.1

MODEL NO.	DESCRIPTION	LENGTH (FT.)	MAX. LOAD (LBS.)	PRICE EACH		
				1	3	5+
H-7973	Manyard™ I	6	310	\$210	\$205	\$200
H-7974	Manyard™ II			230	225	220

## RETRACTABLE



TURBOLITE™

SCORPION™

TITAN™

Prevents serious accidents in the event of a fall.

- Self-retracting web lanyards brake instantly.

**TurboLite™** – Strong and lightweight for all-day wear.

**Scorpion™** – Swivel hook prevents twisting.

**Titan™** – Extra length for increased mobility.

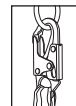

### SNAP HOOK

Attaches to harnesses and anchor points.

Meets ANSI Z359.1

MODEL NO.	DESCRIPTION	LENGTH (FT.)	MAX. LOAD (LBS.)	WT. (LBS.)	PRICE EACH		
					1	3	5+
H-5129	TurboLite™	6	400	3	\$240 each any qty.		
H-4622	Scorpion™	9	310	4	\$375	\$370	\$365
H-9577	Titan™	11	310	4	425	420	415

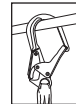

### REBAR HOOK

Connects directly to pipes or scaffolding.

Meets ANSI Z359.1

MODEL NO.	DESCRIPTION	LENGTH (FT.)	MAX. LOAD (LBS.)	WT. (LBS.)	PRICE EACH		
					1	3	5+
H-7963	TurboLite™	6	400	3	\$335	\$330	\$325

# MILLER® HARNESSES

Durable fall protection for warehouse and construction workers.

**Standard H100** – Economical choice. Provides worker safety and meets regulatory compliance.

**H500** – Easy, tangle-free design. Cushioned, removable shoulder pads.

**AirCore™ Deluxe** – Superior comfort. Breathable mesh fabric reduces worker fatigue.

Meets ANSI Z359.1

MODEL NO.	DESCRIPTION	SIZE	WEIGHT CAPACITY	PRICE EACH		
				1	3	5+
H-9578	Standard H100	Universal	400 lbs.	\$50	\$45	\$40
H-9483	H500		420 lbs.	100	95	90
H-5130	AirCore™ Deluxe		400 lbs.	395	390	385



H-9578



H-9483



H-5130

Use with Retractable or Shock-Absorbing Lanyards, see above.

## BOOTIE BUTLER™

Use anywhere. Requires no electricity.



H-2619



STANDARD



WATERPROOF



SUPER BOOTIE



HEAVY DUTY

Protect your client's \$1 million house or the most sensitive laboratory or data room.

- Step in and pull back. Covers are automatically applied.

**Standard** – For carpeted surfaces. Skid resistant. Anti-dust, anti-static polypropylene.

**Waterproof** – For carpeted or tiled surfaces. Lightweight polyethylene.

**Super Bootie** – For tiled and hard floors. Non-skid, water resistant.

**Heavy Duty** – For rough and hard surfaces such as concrete. Extra tough, waterproof bottom.

### BOOTIE BUTLER™

MODEL NO.	DESCRIPTION	SIZE L x W x H	CAPACITY	WT. (LBS.)	PRICE EACH	
					1	2+
H-2618	Small	27 x 13 x 8"	55 pairs	23	\$330	\$325
H-2619	Large	29 x 13 x 30"	110 pairs	46	<b>\$550 any qty.</b>	

### SHOE COVERS

MODEL NO.	DESCRIPTION	SIZE	COLOR	PAIRS/PACK	PRICE PER PACK	
					2	15+
S-16129	Standard	One Size	Blue	40	\$23	\$20
S-21126	Waterproof		Blue	55	27	24
S-16130	Super Bootie		White	40	32	29
S-23389	Heavy Duty		White/Blue	35	35	32

## E-Z FLOOR GUARDS™

Protect your condo floors from the constant traffic of subcontractors.

- Step, pull and tear to apply a sheet of adhesive plastic to your shoes' soles.
- Fits any size shoe and boot.
- Up to 187 pairs per refill roll.



STEP, PULL AND TEAR

MODEL NO.	DESCRIPTION	ROLL SIZE	MIL	ROLLS/CASE	PRICE PER ROLL	
					1	4+
S-22067	Refill Roll	6" x 442'	2.5	4	\$33	\$30
H-6653	Dispenser	24 x 6 x 8"			\$140 ea. 2+/\$135 ea.	

## BOOT COVERS



WATERPROOF

Instant protection for agribusiness and processing plants. Waterproof.

- Slides over large boots to keep foot and calf dry and clean.

**3 MIL POLY** – Approximately 19½" tall

MODEL NO.	SIZE	PAIRS/PACK	PRICE PER PACK	
			1	3+
S-19250	One Size	25	\$19	\$18



SKID RESISTANT

Prevent slips in pharmaceutical and food processing. Water resistant.

- Pulls easily over boots. Poly-coated polypropylene. FDA compliant.

**8 MIL** – Approximately 14" tall

MODEL NO.	SIZE	PAIRS/CARTON	PRICE PER CARTON	
			1	3+
S-24020	6-11	150	\$150	\$145
S-24021	12-15		155	150



VINYL SOLE

Puncture resistance for remodeling and restoration. Water resistant.

- Poly-coated polypropylene with sewn-on vinyl sole. Latex-free.

**8 MIL** – Approximately 10" tall

MODEL NO.	SIZE	PAIRS/CARTON	PRICE PER CARTON	
			1	3+
S-9894	6-11	100	\$155	\$145
S-9895	12-15		160	150

# SHOE COVERS



SKID RESISTANT



WATER RESISTANT



REUSABLE



HEAVY DUTY



STANDARD

SPECIFY COLOR:  White  Blue  Black

MODEL NO.	DESCRIPTION	COLOR	SIZE	PAIRS/CARTON	PRICE PER CARTON	
					1	3+
S-7873 S-7874	Standard	Specify Color	6-11 12-15	150	\$35 any qty. \$36 any qty.	
S-15369 S-15370	Skid Resistant	Specify Color	6-11 12-15	150	\$64 68	\$57 61
S-10481 S-10482	Water Resistant	Blue	6-11 12-15	150	40 41	37 38
S-24608 S-24609	Heavy Duty	White/Blue	6-11 12-15	150	75 80	65 70

**Standard** – For carpeted floors and food service areas. Keeps dirt and dust from workspace. Polypropylene. Non-skid bottom. Latex-free.

**Skid Resistant** – Super-sticky laminated polypropylene. Maintain footing on tile and slippery surfaces. Water resistant.

**Water Resistant** – Keep feet dry and areas clean. Carpet cleaners, contractors, cable installers' choice. Polyethylene. Latex-free.

**Heavy Duty** – For exterminators and HVAC repair. Polypropylene with waterproof, abrasion-resistant bottom.

SPECIFY COLOR:  White  Blue  Black

MODEL NO.	DESCRIPTION	COLOR	SIZE	PAIRS/CARTON	PRICE PER CARTON	
					1	3+
S-19249	Reusable	Specify Color	S, M, L, XL	1	\$21	\$19

**Reusable** – Tough, durable and reusable for up to 12 months. Sewn-on PVC sole. Machine washable nylon.



SINGLE COMPARTMENT

## ACRYLIC DISPENSERS

Hold hairnets, bouffants or shoe covers.

- Hinged lid for easy replenishment.
- Set on table or wall mount.

**Dual and Multi-Compartment** – Organize and store a variety of items and sizes.



DUAL

MULTI

MODEL NO.	DESCRIPTION	SIZE H x W x D	SHOE COVER CAPACITY	PRICE EACH	
				1	4+
H-4164	Single Compartment	11 x 8 x 6"	50 pairs	\$78	\$75
H-1295	Single Compartment	16 x 12 x 8"	200 pairs	95	92

MODEL NO.	DESCRIPTION	SIZE H x W x D	SHOE COVER CAPACITY	PRICE EACH	
				1	4+
H-8473	Dual Compartment	12 x 12 x 6"	100 pairs*	\$101	\$97
H-6139	Multi-Compartment	12 x 18 x 6"	150 pairs*	124	120

\* 50 Shoe Cover pairs per compartment



H-8475

H-8474

## STAINLESS STEEL DISPENSERS

Long lasting, corrosion-resistant for kitchens, labs and heavy manufacturing.

- Hold hairnets, bouffants, beard nets or shoe covers.

MODEL NO.	DESCRIPTION	SIZE H x W x D	SHOE COVER CAPACITY	PRICE EACH	
				1	4+
H-8474	Single Compartment	11 x 8 x 6"	50 pairs	\$150	\$145
H-8475	Multi-Compartment	12 x 18 x 6"	150 pairs*	250	240

\* 50 Shoe Cover pairs per compartment



# ULINE DELUXE PROTECTIVE CLOTHING



All the features of the best at a lesser price for non-hazardous wet and dry environments.

- Recommended for automotive refinishing, waste cleanup and paint spraying.
- Protects against aerosols, liquids and dust.
- Generously sized for easy movement.



MEETS ANSI/ISEA 101-1996

MODEL NO.	DESCRIPTION	SIZE	QTY./ BOX	PRICE PER BOX	
				1	3+
S-17924	Coverall			\$105	\$95
S-17925	Elastic Coverall	M, L, XL, 2XL, 3XL	25	120	110
S-17926	Coverall w/ Hood			125	115
S-17927	Deluxe Coverall			130	120
S-17928	18" Sleeve			One Size Fits All	100 pr.



## DELUXE LAB COAT

Maximum protection for non-hazardous wet and dry environments.

- Recommended for automotive spray painting and refinishing.
- Protects against aerosols, liquids and dust. Splash resistant.
- Snap front, fold-down collar and elastic wrists. No pockets.

## FLAME RETARDANT COVERALL

Wear over your everyday flame-resistant clothing to keep it clean.

- Recommended for welding, utilities and mining operations.
- Protects against dirt, grease and light liquid splash.
- Self-extinguishing after flame source is removed.



MODEL NO.	DESCRIPTION	SIZE	QTY./ BOX	PRICE PER BOX	
				1	3+
S-24015	Lab Coat, No Pockets	M, L, XL, 2XL, 3XL	25	\$95	\$85

MODEL NO.	DESCRIPTION	SIZE	QTY./ BOX	PRICE PER BOX	
				1	3+
S-23371	Coverall w/ Hood	L, XL, 2XL, 3XL	25	\$220	\$210

# ULINE INDUSTRIAL PROTECTIVE CLOTHING

Breathable, cloth-like fabric for all-day comfort.

- Recommended for agriculture, fiberglass processing and equipment maintenance.
- Protects against dirt, grease and light liquid splash.
- SMS 3-layer polypropylene material for extended wear. Resists tearing and abrasion.

MODEL NO.	DESCRIPTION	SIZE	QTY./ BOX	PRICE PER BOX	
				1	3+
S-23370	Lab Coat, No Pockets			\$68	\$65
S-22211	Elastic Coverall	M, L, XL, 2XL, 3XL	25	79	76
S-22212	Coverall w/ Hood			83	80
S-22213	Deluxe Coverall			88	84

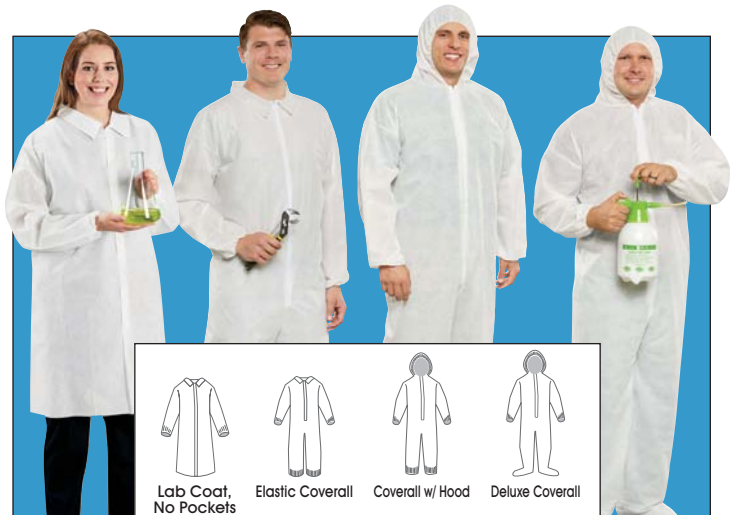

# ULINE ECONOMY PROTECTIVE CLOTHING



## Disposable and economical.

- Recommended for parts assembly, general maintenance and light manufacturing.
- Breathable polypropylene material provides a lightweight protective barrier.
- Protects against dust and grime. • Dark blue hides dirt and stains. • Non-allergenic, resists mildew.



### LAB COATS

\* Only available in White

MODEL NO.	DESCRIPTION	SIZE	QTY./BOX	PRICE PER BOX	
				1	5+
S-15374	No Pockets, Snap Front	M, L, XL, 2XL, 3XL, 4XL	25	\$37	\$34
S-10483*	1 Pocket, Snap Front			39	36
S-23358*	No Pockets, Hook-and-Loop			43	40
S-7872	Apron	One Size	100	1/\$44	3+/\$41

### COVERALLS

SPECIFY COLOR:  White  Navy

MODEL NO.	DESCRIPTION	SIZE	QTY./BOX	PRICE PER BOX	
				1	5+
S-10484	Coverall, Zip Front	M, L, XL, 2XL, 3XL, 4XL	25	\$46	\$43
S-15375	Elastic, Zip Front			49	46
S-17930	Deluxe, Hooded, Zip Front			57	54
S-23359*	18" Sleeve	One Size	100 pr.	33	30

# ULINE SPECIALTY PROTECTIVE CLOTHING



Disposable polypropylene protects against dirt and grime.

- For hospitals, labs, clinics and testing facilities.

**Isolation Gown** – Protection from cross-contamination.

**Fluid-Resistant Gown** – Provides light splash protection.

**Knit Cuff Lab Coat** – Knit wrists and collar for added comfort and protection. 3 pockets, snap front.

SPECIFY COLOR:  Yellow  White  Blue

MODEL NO.	DESCRIPTION	SIZE	QTY./BOX	PRICE PER BOX	
				1	5+
S-24019	Isolation Gown	One Size	50	\$57	\$53
S-17099*	Fluid-Resistant Gown			62	58
S-24018▲	Knit Cuff Lab Coat	L, XL, 2XL, 3XL	25	50	47

\* Only available in White

▲ Available in White and Blue

## CLOTHING DESCRIPTIONS

**Lab Coat, 1 Pocket:** Snap front, fold-down collar, elastic wrists.

**Lab Coat, No Pockets:** Snap front, fold-down collar, elastic wrists.

**Coverall:** Zip front, fold-down collar, open wrists and ankles.

**Elastic Coverall:** Zip front, fold-down collar, elastic wrists and ankles.

**Coverall with Hood:** Zip front, elastic wrists and ankles.

**Deluxe Coverall:** Zip front, attached booties, elastic hood and wrists.

**Gown:** Elastic wrists, ties in back at neck and waist.

**Pants:** Elastic waist and open ankles.

**Sleeve:** Elastic wrist and arm.

**Apron:** Bib style, extra-long ties, bound neck.

**Hood:** Shoulder-length pullover. Elastic around face for snug fit.

**Shoe Cover:** Elastic ankles. 5" high. Serged seams.

**Boot Cover:** Elastic tops for tight grip. 18" high. Serged seams.

# PROSHIELD® BASIC PROTECTIVE CLOTHING



Breathable, soft, cloth-like fabric for all-day comfort.

- Protects against dirt, grime and non-hazardous dry dust.
- Recommended for janitorial, hospital workers and fiberglass processing.
- Resists tearing and abrasion.

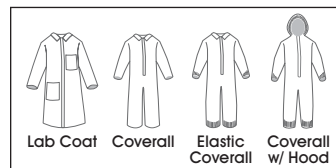

MODEL NO.	DESCRIPTION	SIZE	QTY./ BOX	PRICE PER BOX	
				1	3+
S-15417	Lab Coat	M, L, XL, 2XL	30	\$85	\$75
S-15418	Coverall	M, L, XL, 2XL, 3XL	25	85	75
S-15419	Elastic Coverall			90	80
S-15420	Coverall w/ Hood			100	90

## ULINE COOLFLOW CLOTHING



Protection and breathability for hot, humid conditions.

- Recommended for agriculture and environmental remediation.
- Protection against dust, aerosols and liquid splash.
- Microporous material with SMS back keeps you **30% cooler**.

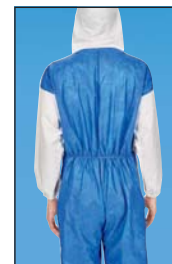

MODEL NO.	DESCRIPTION	SIZE	QTY./ BOX	PRICE PER BOX	
				1	3+
S-25042	Elastic Coverall	L, XL, 2XL, 3XL	25	\$95	\$90
S-24611	Coverall w/ Hood			100	95
S-25043	Deluxe Coverall			105	100

## ULINE PROTECTIVE CLOTHING



### POLYETHYLENE GOWN

Easy on and off. Perforated for quick tear-away removal.

- Recommended for labs, sanitation and food processing.
- Protects against liquids, grease and oils.
- Thumb loops keep sleeves from sliding up. Ties in back at waist.

SPECIFY COLOR:  Blue  White

MODEL NO.	DESCRIPTION	SIZE	QTY./ BOX	PRICE PER BOX	
				1	5+
S-24616	Polyethylene Gown	One Size	100	\$105	\$100

### DISPOSABLE SCRUBS

Versatile, protective scrubs for more than just medical use.

- Recommended for manufacturing, painting and pharmaceuticals.
- Protects against dirt and light liquid splash.
- Breathable, SMS polypropylene fabric resists tearing and abrasion.

SPECIFY COLOR:  Navy  White

MODEL NO.	DESCRIPTION	SIZE	QTY./ BOX	PRICE PER BOX	
				1	3+
S-24601	Shirt w/ Pockets	M, L, XL, 2XL	50	\$80	\$77
S-24602	Pants w/ Pocket			90	87





# TYVEK® PROTECTIVE CLOTHING



Industry leading. Best tear and puncture resistance.

- Recommended for agriculture, food processing and environmental cleanup.
- Excellent protection against hazardous dry dust and aerosols and non-hazardous liquid splash.

Accessories available for head to toe protection



MODEL NO.	DESCRIPTION	SIZE	QTY./ BOX	PRICE PER BOX	
				1	3+
S-9647	Lab Coat	S, M, L, XL,	30	\$180	\$170
S-15410	Lab Coat, No Pockets	2XL, 3XL, 4XL		190	180
S-9636	Coverall	M, L, XL, 2XL, 3XL, 4XL, 5XL	25	185	175
S-13894	Elastic Coverall			205	195
S-11495	Coverall w/ Hood			215	205
S-13895	Deluxe Coverall			220	210
S-22937	Shirt	M, L, XL, 2XL	50	280	270
S-13892	Pants			205	195

MODEL NO.	DESCRIPTION	SIZE	QTY./ BOX	PRICE PER BOX		
				1	3+	
S-13893	18" Sleeve	One Size Fits All	100 pr.	\$135	\$125	
S-15415	Apron			100	185	175
S-14615	Hood			100	150	140
S-14616	Shoe Cover			100 pr.	135	125
S-15494	Boot Cover			50 pr.	115	105

## TYCHEM® QC PROTECTIVE CLOTHING

The strength of Tyvek® with a splash resistant, light chemical barrier.

- Recommended for petroleum, chemical and pharmaceutical industries.
- Excellent protection in low risk wet or hazardous dry environments.
- Durable, lightweight polyethylene-coated Tyvek® fabric.

### COVERALLS

MODEL NO.	DESCRIPTION	SIZE	QTY./ BOX	PRICE EACH (MIN. 4)	PRICE PER BOX
S-19204	Elastic Coverall	M, L, XL, 2XL, 3XL, 4XL	12	\$13.75	\$145
S-19205	Deluxe Coverall			16.00	165

### SLEEVE

MODEL NO.	DESCRIPTION	SIZE	QTY./ BOX	PRICE/PAIR (MIN. 20 PR.)	PRICE PER BOX
S-19206	18" Sleeve	One Size Fits All	100 pr.	\$3.00	\$250



## CHEMICAL-RESISTANT SHOE COVERS

Protects against grease, oil and chemicals in refineries, agribusiness and laboratories.

- Thick and tough poly-coated polypropylene.
- Latex-free. Water resistant.

MODEL NO.	DESCRIPTION	COLOR	SIZE	PAIRS/ CARTON	PRICE PER CARTON	
					1	3+
S-23347	Chemical Resistant	Yellow	6-11	150	\$115	\$105
S-23348			12-15		120	110

# APRONS



## NEOPRENE

Protects against chemicals and oils.

- For refinery workers and industrial mechanics.
- Lightweight and tear resistant with hemmed edges.



## DENIM

Rugged. For use in warehouses, shop rooms, stockrooms.

- Grease and grime protection.
- 100% cotton denim with 2 large pockets.



ONE SIZE FITS ALL SPECIFY COLOR:  Black  Yellow

MODEL NO.	QTY./ CARTON	PRICE EACH (MIN. 3)	
		3	12+
S-18815	12	\$21	\$20

ONE SIZE FITS ALL

MODEL NO.	QTY./ CARTON	PRICE EACH (MIN. 3)	
		3	12+
S-9892	72	\$9	\$8

Apron resists liquids, grease and oils.

- Use in food handling and pharmaceuticals.
- Convenient dispenser box.

ONE SIZE FITS ALL SPECIFY COLOR:  White  Blue

MODEL NO.	QTY./ CARTON	PRICE PER CARTON	
		1	5+
S-10485	100	\$22	\$20



## PVC

Thick, 18 mil. Protects from oils, fats and chemicals.

- Used in food and chemical processing plants.
- Abrasion and puncture resistant. Sealed grommets.



## VINYL

Protection against grease and oils.

- For janitorial and food processing.
- 6 mil vinyl with reinforced grommets.



ONE SIZE FITS ALL

MODEL NO.	QTY./ CARTON	PRICE EACH (MIN. 3)	
		3	12+
S-19901	12	\$10	\$9

ONE SIZE FITS ALL

MODEL NO.	QTY./ PACKAGE	PRICE PER PACKAGE	
		1	3+
S-18820	12	\$29	\$27

Protection from dirt and grime.

- Recommended for use in labs, manufacturing and general cleaning.
- Coated poly for splash protection.

ONE SIZE FITS ALL SPECIFY COLOR:  White  Blue

MODEL NO.	QTY./ CARTON	PRICE PER CARTON	
		1	3+
S-7872	100	\$44	\$41

## CLOTH

Washable. For use in kitchens, labs and retail shops.

- Protects against dirt, spills and splashes.
- Poly/cotton blend with hemmed edges.



## LEATHER

Heavy duty. For welding, metal and machine shops.

- Protects against cuts, sparks and abrasions.
- Flame resistant Kevlar® stitching.



ONE SIZE FITS ALL SPECIFY COLOR:  White  Black

MODEL NO.	QTY./ CARTON	PRICE EACH (MIN. 3)	
		3	12+
S-21139	72	\$10	\$9

ONE SIZE FITS ALL

MODEL NO.	QTY./ CARTON	PRICE EACH	
		1	3+
S-21140	36	\$46	\$44

# HAIRNETS

LATEX FREE

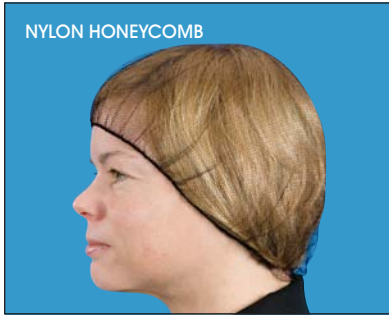

NYLON HONEYCOMB

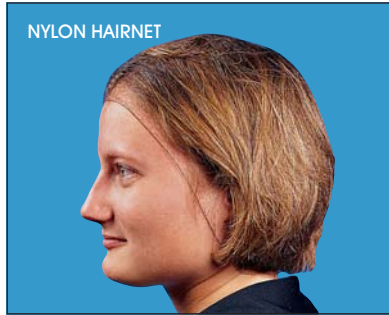

NYLON HAIRNET



POLYPROPYLENE BOUFFANT

**Nylon Honeycomb Hairnet** – Thicker mesh. Much easier to use.

- Recommended for fast food and commercial kitchens.

**Nylon Hairnet** – Invisible mesh keeps you cool and comfortable.

- Provides a better appearance when working with customers.

SPECIFY COLOR:  White  Blue  Red  Green  Yellow

MODEL NO.	DESCRIPTION	SIZE	QTY./PACK	PRICE PER PACK (MIN. 3)		
				3	10	20+
S-9891		18"		\$6.00	\$5.50	\$5.00
S-7024	Polypropylene Bouffant	21"	100	6.00	5.50	5.00
S-10480		24"		7.00	6.50	6.00
S-19897		28"		11.00	10.00	9.00

SPECIFY COLOR:  White  Black  Brown

S-15371*	Nylon Honeycomb Hairnet	20"	100	\$17	\$15	\$13
S-15372*	Nylon Hairnet	24"		20	18	16
S-7025	Nylon Hairnet	22"	144	20	18	16

\*Also available in Blue

**Polypropylene Bouffant** – Recommended for pharmaceutical and manufacturing.

- Provides full hair coverage. 4 sizes available.
- Lightweight and breathable.
- Comfortable, secure fit. Wear all day.

# BEARD NETS

LATEX FREE

## POLYPROPYLENE

Covers beard, mustache and sideburns.

- Recommended for pharmaceutical and manufacturing facilities.



## NYLON HONEYCOMB

Soft, thicker mesh provides all-day comfort.

- For restaurants and commercial kitchens.



## COMBO

Full-head coverage. Lightweight, breathable polypropylene.

- For food prep, labs and medical facilities.



SPECIFY COLOR: White or Blue

MODEL NO.	SIZE	QTY./PACK	PRICE/PACK (MIN. 3)		
			3	10	20+
S-9635	One Size	100	\$7.00	\$6.50	\$6.00

SPECIFY COLOR: White, Black or Brown

MODEL NO.	SIZE	QTY./PACK	PRICE/PACK (MIN. 3)		
			3	10	20+
S-17937	One Size	100	\$11	\$10	\$9

SPECIFY COLOR: White or Blue

MODEL NO.	SIZE	QTY./PACK	PRICE/PACK (MIN. 3)		
			3	10	20+
S-21130	One Size	100	\$17	\$15	\$13

# PLEATED BOUFFANT

Pre-folded, provides fast, easy dispensing.

- For industrial use and food processing.
- Latex-free polypropylene.



SPECIFY COLOR: White or Blue

MODEL NO.	SIZE	QTY./PACK	PRICE/PACK (MIN. 3)		
			3	10	20+
S-23356	24"	200	\$12	\$11	\$10

# POLYETHYLENE CAP

Waterproof shower cap. For janitorial, spa and salon use.

- Protects against liquid splashes and aerosols.
- Latex-free.



MODEL NO.	SIZE	QTY./PACK	PRICE/PACK (MIN. 3)		
			3	10	20+
S-23357	21"	100	\$9.00	\$8.50	\$8.00

# SPRAY SOCK

Protect your noggin when spray painting.

- Lightweight 100% cotton.
- Disposable.
- Use with goggles or respirators.



MODEL NO.	SIZE	QTY./PACK	PRICE/PACK (MIN. 2)	
			2	12+
S-19896	One Size	12	\$15	\$14



# HEAVY DUTY RAINWEAR

## CLASS 3 TINGLEY®

Stay dry and visible as the weather turns cooler.

- Weatherproof, breathable woven polyester allows heat to escape. Machine washable.
- 360° 2" wide hi-vis reflective tape.



**Jacket** – Features roll-away hood, mesh liner and 5 outer pockets.

**Overalls** – Quick-release suspenders. Take-up snaps on waist. Hook and loop ankles.



SPECIFY COLOR: Lime or Orange

MODEL NO.	DESCRIPTION	SPECIFY SIZE	PRICE EACH		
			1	3	6+
S-19979	Heavy Duty Jacket	L, XL, 2XL	\$99	\$94	\$89

Meets ANSI/ISEA 107-2015

SPECIFY COLOR: Lime or Orange

MODEL NO.	DESCRIPTION	SPECIFY SIZE	PRICE EACH		
			1	3	6+
S-19980	Heavy Duty Overalls	L, XL, 2XL	\$63	\$60	\$57

Meets ANSI/ISEA 107-2015

## FLEECE JACKET

### CLASS 2 TINGLEY®

Be safe, be comfortable. Warmth and visibility for 3 seasons.

- For landscaping crews, event staff and emergency responders.
- Can be zipped into S-19979 Heavy Duty Rain Jacket to add warmth.
- Zip front with storm flap, waist drawcord, 4 outside pockets.



MODEL NO.	DESCRIPTION	SPECIFY SIZE	PRICE EACH	
			1	3+
S-24343	Fleece Jacket	L, XL, 2XL	\$77	\$72

Meets ANSI/ISEA 107-2015

## FLEX-VIS RAINWEAR

### CLASS 3 REFLECTIVE

Flexible, high-stretch fabric won't restrict movement in demanding jobs.

- For utility, municipality and construction workers.

**Jacket** – Roll-away hood and 3 outer pockets. "X" back.

**Pants** – Elastic waist with drawcord. Zippered ankles.



MODEL NO.	DESCRIPTION	SPECIFY SIZE	PRICE EACH		
			1	3	6+
S-24603	Jacket	M, L, XL, 2XL	\$80	\$75	\$70
S-24604	Pants	M, L, XL, 2XL	60	57	54

Meets ANSI/ISEA 107-2015

## FROGG TOGGS® RAIN SUIT

Velvety soft. So smooth you have to feel it to believe it.

- For facilities, transportation and grounds crews.
- Polypropylene with waterproof welded seams.
- Zipper front, adjustable hood, elastic wrists and waist.



LIGHTWEIGHT SPECIFY COLOR: Green, Khaki or Blue

MODEL NO.	DESCRIPTION	SPECIFY SIZE	PRICE EACH		
			1	12	24+
S-24661	Rain Suit	M, L, XL, 2XL	\$35	\$33	\$31

## BREATHABLE RAINWEAR

Stay cool, dry and comfortable on warm, rainy days.

- For maintenance, landscaping and agriculture workers.

**Jacket** – Zipper closure, hood, 3 outer pockets.

**Pants** – Drawstring elastic waist, back pocket and cuff snaps.



RIPSTOP

MODEL NO.	DESCRIPTION	SPECIFY SIZE	PRICE EACH		
			1	5	10+
S-22980	Jacket	L, XL, 2XL	\$50	\$47	\$45
S-22981	Pants	L, XL, 2XL	40	37	35

# LIGHTWEIGHT RAINWEAR

## CLASS 3 REFLECTIVE

Breathable, hi-vis protection for summer days.

- 100% waterproof with stitched and taped seams.

**Jacket** – Zipper closure, roll-away hood and 5 outer pockets.

**Pants** – Elastic waist with adjustable drawcord. Hook and loop ankles. Reach-through pockets.



**Poncho** – Snap side closure. Hood with drawcord and wire brim, 1 outer pocket.

- One size fits all.



SPECIFY COLOR: Orange or Lime

MODEL NO.	DESCRIPTION	SPECIFY SIZE	PRICE EACH		
			1	3	6+
S-22970	Lightweight Jacket	M, L, XL, 2XL	\$52	\$49	\$47
S-22971	Lightweight Pants		42	39	37

Meets ANSI/ISEA 107-2015

MODEL NO.	DESCRIPTION	SIZE	PRICE EACH		
			1	3	6+
S-23346	Lightweight Poncho	55 x 80"	\$38	\$35	\$33

Meets ANSI/ISEA 107-2015

## ECONOMY RAIN SUIT

Work in the rain. 3-piece PVC suit.

- Includes overalls, jacket and hood.
- Snap front, wrists and ankles.

**Rain Boots** – Waterproof. Slip easily over shoes.



- Cleated sole for a sure grip.
- 17 inches high.



MODEL NO.	DESCRIPTION	SPECIFY SIZE	PRICE EACH		
			1	6	12+
S-10489	Rain Suit	L, XL, 2XL, 3XL	\$19	\$18	\$17
S-10486	Rain Boots	Men's: 11-14	43	41	39

## DELUXE PVC

Flame and chemical resistant. Used by refineries and utility workers.

- Withstands tears and punctures.

**Jacket** – Wrist and hood snaps.



**Pants** – Adjustable waist, ankle snaps.

**Coat** – Two pockets.



MODEL NO.	DESCRIPTION	SPECIFY SIZE	PRICE EACH		
			1	6	12+
S-18127	Jacket		\$22	\$21	\$20
S-18129	Pants	L, XL, 2XL, 3XL	20	19	18
S-18130	Long Coat		35	34	33

Meets ASTM D6413

## REUSABLE PONCHO

Keeps you dry and comfy.

- Individually packaged. Stick in your boat, deer stand or car.
- Heat-sealed seams. Side and neck snaps. Attached hood with drawstring.
- Breathable .33 mm polyurethane with knit lining. Buttery soft.
- One size fits all.



SPECIFY COLOR: ■ Red ■ Black

MODEL NO.	DESCRIPTION	SIZE	PRICE EACH		
			1	5	15+
S-24265	Reusable Poncho	53 x 80"	\$37	\$35	\$33

## DISPOSABLE PONCHO

Handy for outdoor events or job sites.

- Individually packaged. Easily stores in your car, toolbox or sports bag.
- Heat-sealed seams. Reach-through sleeves and attached hood.
- Transparent .02 mm polyethylene.
- One size fits all.



SPECIFY COLOR:  Clear ■ Blue ■ Yellow

MODEL NO.	DESCRIPTION	SIZE	QTY./PACK	PRICE PER PACK		
				1	10	24+
S-15898	Poncho	50 x 80"	12	\$19	\$17	\$15

# POLAR CLOTHING

## CLASS 3 REFLECTIVE

Stay visible and warm during polar vortex temperatures as low as -50°F.

- For highways, warehouses and cold storage facilities.
- Polyester shell with heavy-duty insulation.



**Parka** – Zip front with storm flap, detachable hood, 3 oversized outside pockets.

**Pants** – Elastic waist, zip ankles, 2 pockets. Nylon shell.

**Overalls** – Zip front and legs with storm flaps, adjustable suspenders, 2 pockets.

**Coveralls** – Full body protection. Storm flap on front zipper and legs, detachable hood, 3 outside pockets.



\* SPECIFY COLOR: ■ Lime ■ Orange

MODEL NO.	DESCRIPTION	SPECIFY SIZE	PRICE EACH	
			1	3+
S-24600	Pants	M, L, XL, 2XL, 3XL	\$70	\$65
S-23349*	Parka		120	110

Meets ANSI/ISEA 107-2015

MODEL NO.	DESCRIPTION	SPECIFY SIZE	PRICE EACH	
			1	3+
S-24599	Overalls	M, L, XL, 2XL, 3XL	\$100	\$90
S-24598	Coveralls		180	170

Meets ANSI/ISEA 107-2015

## HI-VIS T-SHIRTS

### CLASS 2 REFLECTIVE

Day/night visibility for highway workers.

- Reflective striping.
- Moisture-wicking polyester.
- Left chest pocket.

**Deluxe** – Black bottom front hides dirt.



BREATHABLE T-SHIRT



DELUXE T-SHIRT

Meets ANSI/ISEA 107-2015

\* SPECIFY COLOR: ■ Lime ■ Orange

MODEL NO.	DESCRIPTION	SPECIFY SIZE	COLOR	PRICE EACH		
				1	12	24+
S-22189*	Breathable	M, L, XL, 2XL, 3XL	Specify	\$13	\$12	\$11
S-23377	Deluxe		Lime	17	16	15

## DELUXE WINTER LINER

Windproof protection against the harshest Arctic blast.

- Versatile, hinged design. Wear as a balaclava, neck warmer, mask or hood.
- Soft thermal fleece with breathable mesh panel around mouth.



SPECIFY COLOR: ■ Lime ■ Black

MODEL NO.	SIZE	PRICE EACH		
		1	3	12+
S-23425	One Size	\$15	\$14	\$13

## POLAR SOFT SHELL JACKET New

### CLASS 3 REFLECTIVE

Flexible and comfortable. Keeps you warm in the dead of winter.

- For truck drivers, general contractors and road crews.
- Polyester shell with heavy-duty insulation and fleece lining.
- Zip front, attached hood, 5 outside pockets. Grip dot sleeves.



SPECIFY COLOR: ■ Lime ■ Black\*

MODEL NO.	DESCRIPTION	SPECIFY SIZE	PRICE EACH	
			1	3+
S-25074	Soft Shell	M, L, XL, 2XL, 3XL	\$115	\$105

\* Black does not meet ANSI standards

Meets ANSI/ISEA 107-2015

## INSULATED VEST New

### CLASS 2 REFLECTIVE

Fleece-lined to keep you warm when the temps drop.

- For delivery drivers and landscapers.
- Insulated polyester. Reverses to navy.
- 3 inside, 3 outside pockets and mic tabs.



MODEL NO.	SPECIFY SIZE	PRICE EACH		
		1	12	24+
S-25044	M, L, XL, 2XL	\$50	\$48	\$46

Meets ANSI/ISEA 107-2015



# HI-VIS CLOTHING



LONG SLEEVE T-SHIRT



SWEATSHIRTS



SOFT SHELL JACKET



BOMBER JACKET

## CLASS 3 REFLECTIVE – HIGH RISK ENVIRONMENTS

360° visibility for road crews, emergency responders.

**Long Sleeve T-Shirt** – Protect arms from the hot summer sun.

- Comfortable, breathable polyester mesh. Left chest pocket.
- Reflective striping for day/night visibility.

**Sweatshirts** – Warmth and visibility for chilly days.

- Soft, comfortable fleece with elastic wrists and waistband.

**Soft Shell Jacket** – Sporty, lightweight protection for cooler months.

- Polyester shell with fleece lining. Zip closure, 3 outside pockets.

**Bomber Jacket** – Insulated and waterproof for winter work.

- Polyester shell with quilted lining. Zip closure, roll-away hood, 4 outside pockets.

Meets ANSI/ISEA 107-2015

MODEL NO.	DESCRIPTION	SPECIFY SIZE	PRICE EACH	
			1	3+
S-21672	Long Sleeve T-Shirt	M, L, XL, 2XL, 3XL	\$17	\$16
S-21670	Crew Sweatshirt	M, L, XL, 2XL	36	33
S-21679	Pullover Hoodie	M, L, XL, 2XL	38	35

Meets ANSI/ISEA 107-2015

MODEL NO.	DESCRIPTION	SPECIFY SIZE	PRICE EACH	
			1	3+
S-21678	Full-Zip Hoodie	M, L, XL, 2XL	\$40	\$37
S-23375	Soft Shell Jacket	M, L, XL, 2XL, 3XL	54	51
S-21675	Bomber Jacket	M, L, XL, 2XL, 3XL	55	52



HOODIE



LONG SLEEVE T-SHIRT



SAFETY VEST



PANTS

## BLACK HI-VIS CLOTHING

Hide the dirt and grime and still be seen. Recommended for security staff and law enforcement.

MODEL NO.	DESCRIPTION	SPECIFY SIZE	PRICE EACH	
			1	3+
S-23050	Full-Zip Hoodie	M, L, XL, 2XL	\$75	\$70
S-23521	Long Sleeve T-Shirt		27	25

MODEL NO.	DESCRIPTION	SPECIFY SIZE	PRICE EACH		
			1	12	24+
S-22907	Safety Vest	S/M or L/XL	\$11	\$10	\$9
S-23051	Rain Pants	L, XL, 2XL	1/\$52	3+/\$49	

## INCIDENT COMMAND VEST



Know who's who at public events and in emergency situations.

- Recommended for concerts and sporting events.
- Solid polyester with hook and loop closure.
- Print your own job title inserts. 1 inside, 1 outside pocket.

SPECIFY COLOR: ■ Lime ■ Red ■ Blue ■ Black

MODEL NO.	DESCRIPTION	SIZE	PRICE EACH		
			1	12	24+
S-24614	Incident Command Vest	One Size	\$18	\$16	\$14

## COLORED SAFETY VEST

Identify visitors or workers by job function.

- Recommended for warehouses, event staff.
- Lightweight polyester mesh.
- 2 inside pockets, 5 outside pockets and mic tabs.



SPECIFY COLOR: ■ Black ■ Blue ■ Red ■ Pink ■ White ■ Green

MODEL NO.	DESCRIPTION	SPECIFY SIZE	PRICE EACH		
			1	12	24+
S-22908	Colored Safety Vest	S/M, L/XL, 2XL/3XL	\$22	\$20	\$18

# MANAGERS' VESTS

ULINE

CLASS 2 REFLECTIVE

DEWALT®



Fully loaded with features and pockets for your phone, tablet, blueprints, radio and badge.

- Recommended for surveyors, engineers and project managers.

**Uline** – Solid polyester front with cool mesh back. 5 inside, 7 outside pockets, cushion neck, mic tabs, grommets and D-ring opening.

**DeWalt®** – Polyester mesh with reinforced stitching. 2 inside, 6 outside pockets, mic tabs, grommets and D-ring opening.



Guys love these!

SPECIFY COLOR: ■ Lime ■ Orange

MODEL NO.	DESCRIPTION	SPECIFY SIZE	PRICE EACH		
			1	12	24+
S-25057	Uline Vest	M, L, XL, 2XL	\$40	\$38	\$36

Meets ANSI/ISEA 107-2015

MODEL NO.	DESCRIPTION	SPECIFY SIZE	PRICE EACH		
			1	12	24+
S-24709	DeWalt® Vest	M, L, XL, 2XL, 3XL	\$35	\$33	\$31

Meets ANSI/ISEA 107-2015



## FLAME-RESISTANT COVERALLS

New

Wear when working around hot, flammable or high voltage machines and equipment.

- Recommended for welding, vehicle manufacturing and mechanical repairs.
- Comfortable, 100% flame-resistant cotton.
- 2-way zipper. 6 outside, 2 reach-through pockets.
- Machine washable.

ARC FLASH CAT 2

MODEL NO.	DESCRIPTION	SPECIFY SIZE	ARC RATING	PRICE EACH	
				1	5+
S-25126	Coveralls	L, XL, 2XL	8.7 cal/cm <sup>2</sup>	\$95	\$85

Meets NFPA 70E/NFPA 2112



## FLAME-RESISTANT LINER New

Protect your head from sparks and arc flash.

- Recommended for electrical work and data centers.
- Soft blended fabric. Wear with hard hat or on its own.

ARC FLASH CAT 2

MODEL NO.	SIZE	ARC RATING	PRICE EACH		
			1	3	12+
S-25063	One Size	8.4 cal/cm <sup>2</sup>	\$35	\$34	\$33

Meets NFPA 70E/NFPA 2112

## ELECTRICAL GLOVES

ANSELL ACTIVARMR®

Protect yourself from shock and electrocution.



See [uline.com](http://uline.com)

## COLD STORAGE CLOTHING

REFRIGIWEAR®

Work comfortably in the coldest conditions. Keeps workers warm down to -50°F.

- Warm, quilted liners with durable, water-repellant outer shells. Knit wrists.

**Jacket** – Zip front with storm flap, 2 side pockets.

**Parka** – Zip front with storm flap, 3 pockets, fleece neck.



Additional Refrigiwear®, see [uline.com](http://uline.com)

MODEL NO.	DESCRIPTION	SPECIFY SIZE	PRICE EACH	
			1	3+
S-21699	Jacket	L, XL, 2XL	\$72	\$67

MODEL NO.	DESCRIPTION	SPECIFY SIZE	PRICE EACH	
			1	3+
S-21700	Parka	L, XL, 2XL	\$151	\$141

## BREAKAWAY VEST



### CLASS 2 REFLECTIVE

Tears away easily if caught on machinery to prevent injuries.

- Breathable polyester mesh with hook-and-loop closure.



BREAKAWAY VEST

SPECIFY COLOR: ■ Lime ■ Orange

MODEL NO.	SPECIFY SIZE	PRICE EACH		
		1	12	24+
S-16171	L/XL or 2XL/3XL	\$13	\$12	\$11

Meets ANSI/ISEA 107-2015

## SAFETY VESTS



### CLASS 2 REFLECTIVE – MEETS GOVERNMENT REGULATIONS

Recommended for highways, utility and emergency work.

**Standard Vest** – Breathable polyester mesh. Hook-and-loop closure.

**Standard Vest with Pockets** – 1 inside pocket, 3 outside pockets.

**Black Bottom Vest with Pockets** – 3 outside, 2 inside pockets. Bottom hides dirt.

Meets ANSI/ISEA 107-2015

SPECIFY COLOR: ■ Lime ■ Orange

MODEL NO.	DESCRIPTION	SPECIFY SIZE	PRICE EACH		
			1	12	24+
S-12517	Standard Vest		<b>\$8 each any quantity</b>		
S-21682	Standard Vest w/ Pockets	S/M, L/XL, 2XL/3XL or 4XL/5XL	\$11	\$10	\$9
S-21681	Black Bottom Vest w/ Pockets		12	11	10

## X-BACK VEST

### CLASS 2 REFLECTIVE

Enhanced visibility.

- Breathable polyester mesh.
- Zipper closure.
- Machine washable.
- 1 inside pocket.



SPECIFY COLOR: ■ Lime ■ Orange

MODEL NO.	SPECIFY SIZE	PRICE EACH		
		1	12	24+
S-24029	S/M, L/XL, 2XL/3XL or 4XL/5XL	\$20	\$18	\$16

Meets ANSI/ISEA 107-2015

## DELUXE VESTS

Contrasting reflective striping for day/night visibility. Zipper closure.

**Deluxe Vest** – Comfortable polyester mesh. 1 inside pocket.

**Deluxe Vest with Pockets** – Durable fabric front with cool mesh back.

2 inside, 5 outside pockets. Black bottom hides dirt.

### CLASS 2 REFLECTIVE



Meets ANSI/ISEA 107-2015

SPECIFY COLOR: ■ Lime ■ Orange

MODEL NO.	DESCRIPTION	SPECIFY SIZE	PRICE EACH		
			1	12	24+
S-14711	Deluxe Vest	S/M, L/XL, 2XL/3XL or 4XL/5XL	\$19	\$17	\$15
S-21676	Deluxe Vest w/ Pockets		21	19	17

## SOLID VEST

### CLASS 2 REFLECTIVE

Tough and durable for landscaping and agriculture.

- Solid polyester.
- Hook-and-loop closure.
- Machine washable.



1 INSIDE POCKET

SPECIFY COLOR: ■ Lime ■ Orange

MODEL NO.	SPECIFY SIZE	PRICE EACH		
		1	12	24+
S-23373	S/M, L/XL, 2XL/3XL or 4XL/5XL	\$10	\$9	\$8

Meets ANSI/ISEA 107-2015

## GENERAL PURPOSE VESTS

Safety vests for warehouse staff and traffic coordinators.

- Breathable polyester mesh. Hook-and-loop closure. Washable.

**Hi-Vis Safety Vest** – Provides instant visibility in high-traffic areas.

**Hi-Vis Reflective Vest** – Striping gives extra visibility in dark or low light areas.



\* SPECIFY COLOR: ■ Lime ■ Orange ■ Blue ■ Red

MODEL NO.	DESCRIPTION	SPECIFY SIZE	COLOR	PRICE EACH (MIN. 2)		
				2	25	50+
S-9912*	Hi-Vis Safety Vest	S/XL or 2XL/3XL	Specify	\$3.75	\$3.50	\$3.00
S-9913	Hi-Vis Reflective Vest		Lime or Orange	6.50	6.00	5.25



# COOLING ACCESSORIES

## TOWELS

Minimize heat stress and fight fatigue.

- Soak 2-5 minutes in cool water for up to 4 hours of relief.
- Special PVA material provides comfortable fit.

SPECIFY COLOR:  Blue  Gray  Lime

MODEL NO.	DESC.	PRICE EACH (MIN. 2)		
		2	6	12+
S-17088	Towel	\$12	\$11	\$10

## BANDANAS

Cool off while working outdoors or in hot environments.

- Soak for 2-5 minutes in cool water.
- Cooling crystals provide up to 4 hours of relief.



SPECIFY COLOR:



MODEL NO.	DESC.	PRICE EACH (MIN. 6)		
		6	12	24+
S-13925	Bandana	\$3.00	\$2.80	\$2.50

# COOLING VESTS

## EVAPORATIVE

1-2 HOURS

Lightweight, durable and washable.

- Soak 5 minutes in cold water.
- Cools by exposure to open air.
- Hi-vis lime for added visibility.

Zipper front

MODEL NO.	SIZE	WT. (LBS.)	PRICE EACH	
			1	3+
S-17096	M, L, XL, 2XL, 3XL	1	\$46	\$44

## PHASE CHANGE

3 HOURS

Stays cool with 4 gel inserts.

- Put gel inserts in freezer for 45 minutes.
- Includes insulated carrying bag.

Zipper front with hook and loop Includes 4 inserts

MODEL NO.	SIZE	WT. (LBS.)	QTY./PACK	PRICE/PACK	
				1	2+
S-19274	L/XL, 2XL	6	1	\$170	\$165
S-19275	Addl. Inserts	4	4	135	130



## DELUXE

10 HOURS

Use 4 frozen inserts or soak in water.

- Soak vest in water 2-3 minutes to activate cooling technology.
- Elite dual cooling design.

Zipper front

MODEL NO.	SIZE	WT. (LBS.)	QTY./PACK	PRICE/PACK	
				1	2+
S-22256	L, XL	6	1	\$190	\$180
S-22257	Addl. Inserts	5	4	140	130

## DRY EVAPORATIVE

72 HOURS

Stay cool and dry. No soaking or inserts required.

- Fill with 13-20 oz. of cold water.
- Mesh side panels for ventilation.

Zipper front

MODEL NO.	SIZE	WT. FILLED (LBS.)	PRICE EACH	
			1	2+
S-24068	L, XL, 2XL	6	\$200	\$190



## MULTI-BAND



Use as a face mask or cooling headwear.

- Soak 1 minute in cold water for up to 3 hours of relief.

- Moisture-wicking and odor-free with UPF 50+ protection.
- Machine washable.

SPECIFY COLOR:  Lime  Black  Blue

MODEL NO.	DESC.	PRICE EACH (MIN. 2)		
		2	6	12+
S-23924	Multi-Band	\$15	\$14	\$13

## RANGER HAT

Sun protection combined with high visibility.

- Soak 1 minute in cold water for up to 4 hours of relief.
- 100% polyester lined with PVA cooling material.
- ANSI compliant reflective tape.



MODEL NO.	SIZE	PRICE EACH (MIN. 2)	
		2	6+
S-22065	L/XL	\$17	\$16

## ARM SLEEVES

Protect your arms from the blazing summer sun.

- Soak 1 minute in cold water for up to 3 hours of relief.
- Moisture-wicking. Provides UPF 50+ sun protection.
- Machine washable.



SPECIFY COLOR:  Lime  Black  Blue

MODEL NO.	SIZE	PRICE/PAIR (MIN. 2)		
		2	6	12+
S-24710	M, L, XL, 2XL	\$20	\$19	\$18

## SHOWER/EYEWASH



Quickly wash contaminants from eyes or body.

- Twin spray heads.
- Flip-top dust covers.
- Plumbing required.
- Combination drench shower and eyewash bowl in one.
- Recommended for factories and warehouses.

**Guardian** – Galvanized steel piping with protective plastic sleeve.

**Uline** – Powder-coated steel. Safety yellow for easy visibility.

Includes: Emergency sign and inspection tag.



GUARDIAN		Meets ANSI Z358.1-2014		
MODEL NO.	DESCRIPTION	WT. (LBS.)	PRICE EACH	
			1	2+
H-5101	Shower with Eyewash	39	\$785	\$760

ULINE		Meets ANSI Z358.1-2014		
MODEL NO.	DESCRIPTION	WT. (LBS.)	PRICE EACH	
			1	2+
H-6697	Shower with Eyewash	42	\$590	\$565



## FAUCET MOUNT

Turn any faucet into an emergency eyewash station.

- Single faucet with easy pull-knob.
- Flip-top dust covers.
- No plumbing required.
- Recommended for schools and laboratories.

MODEL NO.	DESCRIPTION	HEAD DIAMETER	PRICE EACH	
			1	2+
H-5100	Faucet Mount	1"	\$100	\$98

## WALL MOUNT

Flush eyes quickly and gently with this permanent station.

- Twin spray heads with flip-top dust covers. Built-in filters for clean water.
- Plumbing required.
- Recommended for machine shops, labs and janitorial closets.



Includes: Eyewash station, emergency sign and inspection tag.

Meets ANSI Z358.1-2014				
MODEL NO.	DESCRIPTION	BOWL DIAMETER	PRICE EACH	
			1	2+
H-5457	Wall Mount	11 1/2"	\$230	\$220



## PORTABLE

Be prepared on job sites without proper water supply.

- Pressurized stainless steel tank delivers constant 15-minute flow.
- Twin spray heads. • Flip-top dust covers.
- Wash contaminants from eyes, face or body.
- **Water Preservative** – Add to prevent bacteria and algae for 6 months.

Includes: Eyewash unit, 6' PVC drench hose, inspection tag and water preservative.

Keg Hand Truck sold separately, see [uline.com](http://uline.com) Meets ANSI Z358.1-2014

MODEL NO.	DESCRIPTION	CAPACITY	PRICE EACH	
			1	2+
H-5458	Eyewash Station	15 Gal.	\$1,315	\$1,295
S-21107	Water Preservative	8 oz.	16	15

## SIGNS

Clearly mark eyewash locations.

More information, page 654

MODEL NO.	DESCRIPTION	SIZE	PRICE EACH		
			1	3	5+
S-17343V	Vinyl	7 x 10"	\$10	\$9	\$8
S-17343P	Plastic	7 x 10"	17	16	15
S-17343A	Aluminum	12 x 18"	32	30	28



## INSPECTION TAGS

Attach, record and track inspections.

- Heavy-duty, 15 mil vinyl with 3/8" metal eyelet. Cable ties included.

MODEL NO.	DESCRIPTION	SIZE	QTY./	PRICE/PACK
			PACK	1 3+
S-21108	Vinyl	5 1/4 x 3 1/2"	25	\$44 \$40

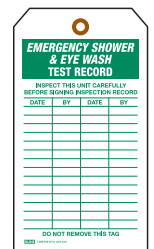

# MOBILE EYEWASH STATION

PRIMARY

Mobility is the king. Excellent choice for smaller warehouses and contractors' job sites.

- Hinged, pull-down tray activates a constant 15-minute flow.
- Self-contained. No plumbing needed.

**Optional Waste Cart** – Built-in collection tank rolls easily on swivel casters: 2 locking, 2 rigid.

**Water Preservative** – Add to prevent bacteria and algae for 6 months.

Includes: Eyewash station, emergency sign, stainless steel wall bracket and inspection tag.

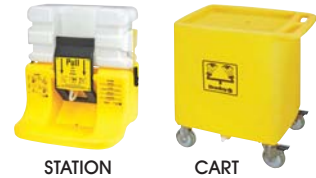

Meets ANSI Z358.1-2014

MODEL NO.	DESCRIPTION	SIZE H x W x D	CAPACITY	WT. (LBS.)	PRICE EACH	
					1	2+
H-6224	Eyewash Station	25 x 22 x 19"	7 Gal.	19	\$345	\$335
H-6170	Waste Cart	33 x 30 x 22"	56 Gal.	40	385	375
S-21107	Water Preservative		8 oz.	1	16	15

■ SHIPS VIA MOTOR FREIGHT



BRADLEY®

# FENDALL FLASH FLOOD® SECONDARY

Provides immediate hands-free eye flushing when a primary station isn't close by.

- Easily mounts to wall with included bracket.
- Pull strap to activate. Delivers constant 3-minute flow.
- 6-month saline life.
- No plumbing needed.

Includes: Secondary eyewash station, 1-gallon saline cartridge and mounting hardware.



MODEL NO.	DESCRIPTION	SIZE H x W x D	TOTAL CAP.	PRICE EACH	
				1	2+
H-7917	Flash Flood® Station	20 x 11 x 14"	1 Gal.	\$225	\$220
S-23004	1 Gal. Saline Refill Cartridge			59	57

# DRENCH HOSES

PRIMARY

Use as an eyewash or pull drench hose to rinse your body.

- Twin spray heads with flip-top dust covers. Built-in filters for clean water.
- 8' PVC hose. Squeeze-handle with locking clip for hands-free use.
- Recommended for labs and warehouses.
- Plumbing required.

Includes: Eyewash drench hose and emergency sign.



Meets ANSI Z358.1-2014

MODEL NO.	DESCRIPTION	HEAD DIAMETER	PRICE EACH	
			1	2+
H-9459	Deck Mount	1 1/2"	\$390	\$380
H-9460	Wall Mount			

# WALL STATIONS

Provides immediate emergency eye flushing when a larger eyewash station is not close by.

Stations Include: Starter bottle(s) of saline solution, wall-mount station and hardware.



H-1174



H-2387

MODEL NO.	DESCRIPTION	SIZE H x W x D	TOTAL CAP.	PRICE EACH	
				1	2+
H-2387	16 oz. Single-Bottle Station	12 x 12 x 4"	16 oz.	\$44	\$42
H-2388	32 oz. Single-Bottle Station	12 x 12 x 4"	32 oz.	46	44
H-6115	16 oz. Two-Bottle Station	12 x 15 x 4"	32 oz.	64	61
H-1174	32 oz. Two-Bottle Station	12 x 15 x 4"	64 oz.	71	68
S-15348	16 oz. Saline Refill Bottle	N/A	16 oz.	13	12
S-10492	32 oz. Saline Refill Bottle	N/A	32 oz.	18	17

SECONDARY

# SINGLE USE

SECONDARY



S-21109

S-18097

S-18096

Single-dose unit for immediate use.

- Delivers drops or constant stream.

MODEL NO.	CAP.	QTY./CASE	PRICE EACH (MIN. 12)		
			12	24	48+
S-18096	1 oz.	24	\$4.25	\$4.00	\$3.75
S-18097	4 oz.		6.25	6.00	5.75
S-21109	8 oz.	12	8.50	8.00	7.50





**PORTA STREAM® II**

Simply pull handle to activate – Leaves hands free to hold eyes open.

- Constant 15-minute flow.
- Economical, 6-month saline life.
- No plumbing needed.



Includes: Eyewash station, saline concentrate, emergency sign, hanging bracket and inspection tag.



**PURE FLOW 1000®**

Self-contained unit collects used eyewash solution for easy cleanup.

- Constant 15-minute flow at 0.4 gpm to thoroughly flush eyes and face.
- 24-month cartridge life – 4 times longer than Porta Stream® II.
- Cover/handle keeps dirt and debris from clogging basin and nozzles.
- No plumbing needed.

Includes: Eyewash station, emergency sign, hanging bracket and inspection tag. Saline cartridges sold separately.



Easy flip-down shelf.

**FENDALL 2000™**

Slim, self-contained unit adapts well to tight spaces.

- Alarm system signals completion of 15-minute flushing requirement.
- Constant 15-minute flow.
- 24-month cartridge life.
- No plumbing needed.

Includes: Eyewash station, emergency sign, installation DVD, mounting bracket and tamper seal. Saline cartridges sold separately.

**PORTA STREAM® II** Meets ANSI Z358.1-2014

MODEL NO.	SIZE H x W x D	CAP.	PRICE EACH	
			1	2+
H-1142	26 x 20 x 20"	16 Gal.	\$460	\$450
S-9876	180 oz. Saline Concentrate Refill		95	90

**PURE FLOW 1000®** Meets ANSI Z358.1-2014

MODEL NO.	SIZE H x W x D	CAP.	PRICE EACH	
			1	2+
H-1297	30 x 29 x 23"	7 Gal.	\$650	\$640
S-11507	Set of two 3½ Gal. Saline Cartridges		250	245

**FENDALL 2000™** Meets ANSI Z358.1-2014

MODEL NO.	SIZE H x W x D	CAP.	PRICE EACH	
			1	2+
H-3838	32 x 17 x 14"	7 Gal.	\$540	\$525
S-19328	7 Gallon Saline Cartridge		357	347

## SLIM FLOW

PRIMARY

Compact design saves space without sacrificing safety.

- Pull-down tray activates a constant 15-minute flow.
- No plumbing needed.



**Water Preservative** – Prevents bacteria and algae for 6 months, see page 720 (S-21107).

Meets ANSI Z358.1-2014

MODEL NO.	SIZE H x W x D	CAP.	PRICE EACH	
			1	2+
H-9832	20 x 16 x 10"	9 Gal.	\$250	\$240

## TRAVEL PACK

SECONDARY



Take emergency eyewash solution wherever you go.

- Delivers drops or constant stream.

Includes: Compact vinyl bag, six 1-oz. and six 4-oz. single-use eyewash bottles.

MODEL NO.	DESCRIPTION	SIZE H x W x D	PRICE EACH	
			1	2+
S-24657	Travel Pack	13 x 9 x 4"	\$93	\$90

## EYEWASH CART

When there are no walls in sight and safety is required.

- Sturdy, powder-coated steel tubing.
- Eyewash station sold separately.



For use with Porta Stream® II, Pure Flow 1000®, Fendall 2000™ and Slim Flow Stations.

Hardware included

MODEL NO.	DESCRIPTION	WT. (LBS.)	PRICE EACH	
			1	2+
H-9839	Cart	40	\$295	\$285



**SERVES UP TO 25 PEOPLE**

**SERVES UP TO 50 PEOPLE**

**SERVES UP TO 100 PEOPLE**

**Class A** – For everyday injuries. Includes assorted bandages, antiseptic wipes, burn cream, CPR protector and eye pads.

**Class B** – For serious accidents. Includes Class A contents, plus tourniquet, splint, triangular bandages and nitrile gloves.

**Class B+** – Comprehensive kit for serious injuries. Includes Class B contents, plus bloodborne pathogen kit and extra medicinals.



For complete list of contents, see [uline.com](http://uline.com)

Meets ANSI Z308.1-2021

MODEL NO.	DESC.	RECOMMENDED FOR	PEOPLE SERVED	ITEMS PER KIT	PRICE PER KIT		
					1	3	5+
H-6469	Class A	Everyday Injuries	25	81	\$65	\$63	\$61
H-6470	Class B	Serious Accidents	50	223	155	150	145
H-8757	Class B+	Serious Injuries	100	623	295	280	270
H-9997			250	903	385	375	365



Replacement supplies, see [uline.com](http://uline.com)



## FINGER TAPE

Works like a second skin.

- Handle small parts, metal, glass and plastic safely.
- Protect fingers and wrists.
- Self-adhesive – Won't stick to skin or hair.



SPECIFY COLOR: Green Blue Tan Black

MODEL NO.	DESCRIPTION	SIZE	ROLLS/CASE	PRICE PER CASE	
				1	4+
S-12528	Finger Tape	3/4" x 30 yds.	16	\$26	\$25

## SUNSCREEN

Protection from harmful UVA/UVB rays.

- Water and sweat resistant.
- Non-greasy 30+ SPF protection.

**Individual Packets** – Convenient wall-mount dispenser.

**Gallon Pump** – Bulk size.



S-20257



MODEL NO.	DESCRIPTION	SIZE	QTY./CTN.	PRICE PER CARTON		
				1	5	10+
S-20257	Sunscreen Packets	1/4 oz.	100	\$70	\$65	\$60
S-22215	Gallon w/ Pump	1 gal.	1	155	150	145



## INSTANT ICE PACKS

Immediate, colder-than-ice treatment for sprains and other minor injuries.

- No refrigeration required.
- Squeeze and shake to activate.
- 20 minutes of cool, relaxing comfort.

MODEL NO.	DESCRIPTION	SIZE	QTY./BOX	PRICE PER BOX	
				1	4+
S-11477	Ice Packs	4 x 5"	24	\$23	\$22
S-20720		5 x 9"		29	28

## BLEED CONTROL KIT

Stop life-threatening blood loss before professional help arrives.

- Wall mountable plastic kit includes mylar blanket, tourniquet, trauma dressing, trauma pads, nitrile gloves, bandage shears and more.



MODEL NO.	DESCRIPTION	PEOPLE SERVED	ITEMS PER KIT	PRICE PER KIT		
				1	3	5+
S-25331	Bleed Control Kit	1	11	\$90	\$88	\$86

# ULINE FIRST AID KITS



**SERVES UP TO 25 PEOPLE**

Plastic kit includes assorted bandages, antiseptic wipes, eyewash, gauze pads, adhesive tape, CPR protector, instant ice pack and much more.

**SERVES UP TO 50 PEOPLE**

Plastic kit includes assorted bandages, antiseptic wipes, eyewash, gauze pads, CPR protector, aspirin, adhesive tape and much more.

**SERVES UP TO 100 PEOPLE**

Metal cabinet includes assorted bandages, antiseptic wipes, eyewash, CPR protector, aspirin, adhesive tape, trauma dressings and much more.



**SERVES UP TO 10 PEOPLE**

Plastic kit includes assorted bandages, antiseptic wipes, burn cream, gauze pads, adhesive tape, gloves, scissors and much more.

## KITS

MODEL NO.	PEOPLE SERVED	ITEMS PER KIT	PRICE PER KIT		
			1	3	5+
H-1292	10	65	\$28	\$26	\$24
H-1293	25	109	40	38	36
H-1294	50	212	76	74	72
H-3319	100	525	199	194	189
H-3795	250	1,076	247	240	234

Replacement supplies, see [uline.com](http://uline.com)



**SERVES UP TO 250 PEOPLE**

For complete list of contents, see [uline.com](http://uline.com)

## BLOODBORNE PATHOGEN KITS



19 PIECE KIT



100 PIECE CABINET

Emergency cleanup kit for blood or bodily fluids in warehouses, offices or schools.

**Single-Use Kit** – Portable. Includes eye shield, mask, gloves, gown with cap, CPR barrier, towelettes, absorbent powder, scraper, scoop bag, biohazard bag and plastic carrying case with handle.

**Wall-Mount Cabinet** – Refillable metal cabinet for larger facilities. See [uline.com](http://uline.com) for complete list of contents.

MODEL NO.	DESCRIPTION	OSHA COMPLIANT PRICE EACH		
		1	3	5+
S-16500	19 Piece Single-Use Kit	\$36	\$33	\$31
H-5434	100 Piece Wall-Mount Cabinet	138	132	127
S-21103	100 Piece Wall-Mount Cabinet Refill	98	95	90

## TRAUMA KIT



Provide life-saving care during critical emergencies.

- Nylon bag includes hemostatic pads, chest seal, mylar blanket, tourniquet, compression bandage, wound seal, burn dressing, EMT scissors and much more.

For complete list of contents, see [uline.com](http://uline.com) Meets ANSI Z308.1-2015 Class B

MODEL NO.	DESCRIPTION	PEOPLE SERVED	ITEMS PER KIT	PRICE PER KIT		
				1	3	5+
H-9954	Trauma Kit	50	234	\$300	\$290	\$280

## EMERGENCY BLANKET

Retains up to 90% of body heat when a blanket is not available.

- Used for marathons and emergency response.
- Individually wrapped. Waterproof.



MODEL NO.	DESCRIPTION	SIZE L x W	QTY./PACK	PRICE PER PACK	
				1	10+
S-23360	Emergency Blanket	84 x 52"	25	\$32	\$30



# SHARPS CONTAINERS



Safe, disposable container for needles, syringes, lancets, razors and sharp objects.

- Recommended for medical facilities, warehouses, schools and rest areas.

**Containers** – Choose from 3 popular sizes. Rigid plastic construction. Puncture resistant.

**Basket** – Secure S-15308 5-qt. container in sturdy, lockable metal wire basket.

**Cabinets** – Lockable cabinets fit S-15308 5-qt. container. S-24610 – Heavy-duty stainless steel for maximum security and a polished look. Corrosion resistant.



Sharps Mailback Kits available, see [uline.com](http://uline.com)

MODEL NO.	SIZE	DESCRIPTION	QTY./ CTN.	PRICE PER CARTON	
				1	2+
S-15307	1-Quart	Container	10	\$42	\$39
S-15308	5-Quart		5	46	43
S-22218	2-Gallon		10	140	135

MODEL NO.	SIZE	DESCRIPTION	QTY./ CTN.	PRICE PER CARTON	
				1	2+
S-16089	5-Quart	Wire Basket	1	\$40	\$37
S-15309		Plastic Cabinet	1	55	52
S-24610		Stainless Steel Cabinet	1	190	180

# COTTON TIPPED APPLICATORS



All-purpose swabs for first aid or cleaning.

- 100% cotton. 3/16" tip with wood shaft.

**Industrial** – Non-sterile. For precision cleaning of parts and equipment.

**Medical** – For treating wounds and specimen collection. 2 per sealed pouch.

MODEL NO.	DESCRIPTION	SIZE	QTY./ BOX	PRICE PER BOX		
				1	5	10+
S-21101	Industrial	3"	1,000	\$19	\$18	\$17
S-18991		6"	1,000			
S-24715	Dual Tipped	6"	500			
S-21102	Medical	6"	200	14	13	12

# TONGUE DEPRESSORS

Versatile tool for medical use, crafts or painting.

- High quality white birch.
- Non-sterile.
- Single use.
- Smooth rounded edges.



MODEL NO.	QTY./ BOX	PRICE PER BOX		
		1	5	10+
S-19178	500	\$18	\$17	\$16

# MEDICATION



S-7660

S-5682

S-23084

S-21095

MODEL NO.	DESCRIPTION	QTY./ BOX	PRICE PER BOX	
			1	4+
S-7660	Advil®	50 2-packs	\$26	\$24
S-5682	Tylenol®		25	23
S-23084	Benadryl®	30 2-packs	27	25
S-21095	Aleve®	50 1-packs	31	29

# ULINE MEDICATION



S-18593

S-18594

S-18592

S-24781

MODEL NO.	DESCRIPTION	QTY./ BOX	PRICE PER BOX	
			2	4+
S-18593	Acetaminophen	50 2-packs	\$11	\$10
S-18594	Sinus & Congestion		13	12
S-18592	Aspirin	50 2-packs	7	6
S-24781	Ibuprofen		13	12

# BAND-AID® BANDAGES



Treat minor cuts and scrapes.

- Choose from durable fabric, everyday plastic or waterproof.
- Waterproof repels sweat. Runners love them.



S-18569

## ULINE

MODEL NO.	DESCRIPTION	QTY./ BOX	PRICE PER BOX (MIN. 2)		
			2	6	12+
S-18569	Fabric 1 x 3"	100	\$9	\$8	\$7
S-18570	Fabric Fingertip	50	9	8	7
S-18571	Fabric Knuckle	50	9	8	7
S-21717	Assorted Pack	280	17	16	15

## BAND-AID®

MODEL NO.	DESCRIPTION	QTY.	PRICE PER BOX		
			1	3	5+
S-7036	Fabric 1 x 3"	100	\$15	\$14	\$13
S-19746	Plastic 3/4 x 3"	60	7	6	5
S-18325	Waterproof 1 x 3 1/4"	20	9	8	7
S-18326	Assorted Pack	280	21	20	19

# NEOSPORIN®



Anytime, anywhere infection protection for minor scrapes, cuts and wounds.

- Triple antibiotic kills infectious bacteria.
- Sanitary single dose packets.

MODEL NO.	QTY./ BOX	PRICE PER BOX		
		1	3	5+
S-15330	144	\$60	\$58	\$56

# VASELINE® *New*



The original healing jelly. Trusted for generations.

- For use in food processing and manufacturing.
- Heals dry skin.
- Soothes minor cuts and burns.

MODEL NO.	SIZE	QTY./ CTN.	PRICE PER JAR (MIN. 6)	
			6	24+
S-25332	13 oz.	6	\$10	\$9

# COTTON BALLS

Apply topical ointments or alcohol to cuts and wounds.

- For everyday use in hospitals and doctors' offices.
- Non-sterile.
- Soft, absorbent 1" cotton balls.



MODEL NO.	QTY./ BAG	PRICE PER BAG (MIN. 5)	
		5	10+
S-16227	200	\$6	\$5

# DISINFECTANT SPRAY

Spray on wounds and abrasions.

- For use in fitness centers and restaurants.
- Prevents infection.
- 70% isopropyl alcohol.



MODEL NO.	SIZE	QTY./ CTN.	PRICE PER CARTON		
			1	2	4+
S-25329	10 oz.	6	\$30	\$28	\$26

# DISINFECTANTS

## 70% ISOPROPYL ALCOHOL

MODEL NO.	SIZE	QTY./ CTN.	PRICE PER CARTON		
			1	2	4+
S-15966	16 oz.	12	\$40	\$37	\$32
S-17474	1 Gal.	4	101	92	82
S-23079	5 Gal.	1	145	130	120
■ S-23080	55 Gal.	1	850	830	805

■ SHIPS VIA MOTOR FREIGHT

## 99% ISOPROPYL ALCOHOL

MODEL NO.	SIZE	QTY./ CTN.	PRICE PER CARTON		
			1	2	4+
S-16419	16 oz.	12	\$54	\$51	\$47
S-17475	1 Gal.	4	140	130	120
S-20735	5 Gal.	1	175	165	150
■ S-21084	55 Gal.	1	995	965	935

■ SHIPS VIA MOTOR FREIGHT

## 70% ISOPROPYL PREP PADS

MODEL NO.	SIZE	QTY./ BOX	PRICE PER BOX (MIN. 4)	
			4	10+
S-16183	1 1/4 x 2 1/2"	200	\$4.00	\$3.50



S-15966



S-16419



S-17475



S-20735



S-21084

## 70% ISOPROPYL ALCOHOL

- Cleans minor cuts and abrasions. Helps prevent the risk of infection.

## 99% ISOPROPYL ALCOHOL

- Disinfects surfaces. Use in labs, schools or clinics.

## 70% ISOPROPYL PREP PADS

- Convenient and sterile. Individually packaged. 2-ply wipes.



S-16183

# COMPLIANCE CENTERS



DELUXE



STANDARD

Keep Safety Data Sheets readily available for quick, easy access.

- Meets OSHA Right-to-Know requirements.

**Standard** – Includes 2" SDS binder, 36" binder security chain and mounting hardware.

**Deluxe** – Includes 2" SDS binder, blue board and bin, and 10 training booklets.

## WALL-MOUNT CENTERS

Bilingual available, see [uline.com](http://uline.com)

MODEL NO.	DESCRIPTION	SIZE H x W x D	PRICE EACH	
			1	3+
S-15383	Standard	20 x 14 x 4"	\$75	\$70
S-18186	Deluxe	30 x 24 x 4"	145	135

## REPLACEMENT BINDERS

MODEL NO.	SHEET CAPACITY	SIZE H x W x D	PRICE EACH	
			1	3+
S-19559	300	11½ x 10½ x 2"	\$16	\$15
S-19560	600	11½ x 12 x 3½"	24	23
S-20974	Wire Basket	9 x 14 x 5"	26	25

# CIRCUIT BREAKER LOCKOUTS

Securely locks out electrical circuit breakers.

- Snaps on. No tools needed.
- Powder-coated steel with reinforced polymer.

MODEL NO.	DESCRIPTION	FITS TOGGLES	PRICE EACH		
			1	6	12+
H-3440	Standard	Single & Double	\$12	\$11	\$10
H-3439	Oversized	Tall & Wide	15	14	13
H-3423	Cable Padlock	All types	14	13	12

- Lockout Padlocks and Tags sold separately.

**Cable Padlock** – Locks up to 3 standard size circuit breaker switches.



# ALUMINUM LOCKOUT PADLOCKS



Lock equipment in harsh outdoor environments to prevent accidents.

- Superior corrosion resistance.



**Keyed Different** – Each lock has its own specific key.

**Keyed Alike** – Each set of 6 locks shares 1 master key.

SPECIFY COLOR: Black, Red, Green, Orange, Yellow or Blue

MODEL NO.	DESCRIPTION	SHACKLE SIZE	PRICE EACH		
			2	6	12+
H-5068	Keyed Different	1½"	\$20	\$19	\$18
H-6698	Keyed Alike	1½"	N/A	22	21

# DIELECTRIC LOCKOUT PADLOCKS

Prevent shock and arc flashing in electrical areas.

- Non-sparking plastic shackle. Zenex™ thermoplastic body.

**Keyed Different** – Each lock has its own specific key.



SPECIFY COLOR: Black, Blue, Green, Orange, Yellow or Red

MODEL NO.	DESCRIPTION	SHACKLE SIZE	PRICE EACH (MIN. 2)		
			2	6	12+
H-6652	Keyed Different	1½"	\$18	\$17	\$16



H-3427

H-3428

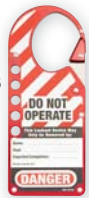

# LOCKOUT HASPS

Allow workers to lock out the same piece of equipment.

- Steel jaw with vinyl-coated handle – H-3426 and H-3427.

- Snap-on aluminum and stainless steel – H-3428.

MODEL NO.	DESCRIPTION	DIAMETER	PRICE EACH (MIN. 2)		
			2	6	12+
H-3426	Small Steel	1"	\$8.00	\$7.50	\$7.00
H-3427	Medium Steel	1½"	9.00	8.50	8.00
H-3428	Aluminum	1¾ x 2½"	20.00	19.00	18.00

# LOCKOUT CABINET

The permanent solution for your lockout supplies.

- Wall-mountable. 3 adjustable shelves.
- Steel construction with clear plastic window. Lockable.
- Keep padlocks, tags and hasps organized. Sold separately.



MODEL NO.	DESCRIPTION	SIZE H x W x D	WT. (LBS.)	PRICE EACH	
				1	3+
H-9511	Cabinet	30 x 15 x 9"	28	\$195	\$190



# LOCKOUT/TAGOUT



## ELECTRICAL KIT

Protect workers from serious injury.

- Lock out circuit breakers and wall switches.
- Large deep carrying case with reinforced latch.

### Includes:

- 3 Keyed-Alike Padlocks
- 1 Circuit Breaker Padlock
- 1 Hasp
- 1 Snap-On Hasp
- 5 Circuit Breaker Lockouts
- 1 Wall Switch Lockout
- 12 Tags

- Refills sold separately.
- Additional tags sold below.

MODEL NO.	ITEMS PER KIT	PRICE EACH	
		1	3+
H-3402	24	\$200	\$195



## TAGS

Alert workers of equipment maintenance.

- Durable polyester laminate resists water and grease.

Cable ties included

MODEL NO.	SIZE W x H	QTY./PACK	PRICE PER PACK		
			1	6	12+
S-18245	3 7/8 x 5 3/4"	12	\$23	\$22	\$21



## LOCKOUT STATIONS

Keep lockout devices organized, easy to find and use.

- Wall mountable for high visibility and convenient access.
- Cover protects contents. Lockable.

### 4-Lock Station Includes:

- 4 Keyed-Different Padlocks
- 2 Hasps • 12 Tags

### 10-Lock Station Includes:

- 10 Keyed-Different Padlocks
- 2 Hasps • 24 Tags

### Electrical Station Includes:

- 6 Keyed-Different Padlocks
- 1 Compact Plug Prong Lockout
- 1 Plug Cover
- 1 Hasp
- 1 Snap-On Hasp
- 6 Circuit Breaker Lockouts
- 2 Wall Switch Covers • 24 Tags

MODEL NO.	DESCRIPTION	ITEMS PER KIT	PRICE EACH	
			1	3+
H-3403	4-Lock Station	18	\$205	\$200
H-3809	10-Lock Station	36	390	380
H-3450	Electrical Station	42	455	435

## LOCKOUT PADLOCKS

MASTER LOCK®



Lock equipment to prevent accidents.

- Corrosion-resistant. Zenex™ body.



Keyed Different – Each lock has its own specific key.

Keyed Alike – Each set of 6 locks shares 1 master key.

SPECIFY COLOR: Black, Blue, Green, Orange, Yellow or Red

MODEL NO.	DESCRIPTION	SHACKLE SIZE	PRICE EACH		
			2	6	12+
H-3422	Keyed Different	1 1/2"	\$17	\$16	\$15
H-5389	Keyed Alike		N/A	19	18

## LOCKOUT PADLOCKS

ULINE

Protect workers. Lock equipment during service and repair.

- 6-pin locking system. Corrosion-resistant plastic body.

Keyed Different – Each lock has its own specific key.

Keyed Alike – Each set of 6 locks shares 1 master key.



SPECIFY COLOR: Red, Black, Blue, Green, Orange or Yellow

MODEL NO.	DESCRIPTION	SHACKLE SIZE	PRICE EACH		
			2	6	12+
H-8621	Keyed Different	1 1/2"	\$12	\$11	\$10
H-8622	Keyed Alike		N/A	14	13

## GROUP LOCK BOX



Store lockout keys for equipment in one group box.

- Lockout keys are only accessible when the last worker removes his assigned padlock.
- Durable stainless steel construction.
- Lockout Padlocks sold separately.

MODEL NO.	DESCRIPTION	SIZE H x L x W	PRICE EACH	
			1	3+
H-5069	12-Lock Box	6 x 9 x 4"	\$88	\$85

## ELECTRICAL PLUG LOCKOUTS

Prevent accidental plug-in of faulty equipment.

- Use during service and repair.
- Rotating design for easy installation in confined spaces.
- Corrosion-resistant Zenex™ shell.



MODEL NO.	DESCRIPTION	FITS PLUG SIZE	PRICE EACH (MIN. 2)		
			2	6	12+
H-3435	Small Plug Cover	2 1/4 x 3 1/4"	\$18	\$17	\$16
H-3436	Large Plug Cover	3 x 6"	23	22	21

# PARKING LOT REPAIR COMPOUNDS

New

## PERMA-PATCH



Make quick, permanent repairs to driveways, parking lots, sidewalks and walls.

- Ready to use formula. No mixing required. Quick dry time.

**Perma-Patch** – Apply in any weather, rain or shine. Immediately ready to drive on. Works in temperatures 0° to 100°F.

**Quikrete** – Natural color and texture blends in seamlessly with concrete surfaces. Sets in 4-6 hours. Works in temperatures 50° to 90°F.

## QUIKRETE



### PERMA-PATCH

MODEL NO.	APPLICATION	SIZE	COVERAGE	PRICE EACH		
				1	6	12+
S-25194	Asphalt	30 lbs.	3 sq. ft. at 1" deep	\$39	\$37	\$35

### QUIKRETE

MODEL NO.	APPLICATION	SIZE	COVERAGE	PRICE EACH (MIN. 2)		
				2	6	12+
S-25195	Concrete	4 lbs.	3 sq. ft. at 1/8" deep	\$16	\$15	\$14

# PARKING LOT STENCILS

REUSABLE

Safely guide cars and delivery trucks without cluttering your parking lot.

- Reuse multiple times in warehouse and office building lots.
- Easy cleanup.

## VISITORS NO PARKING FIRE LANE

MODEL NO.	DESCRIPTION	LETTER SIZE H x W	OVERALL SIZE H x W	PRICE EACH	
				1	3+
S-21110	Visitors		18 x 72"		
S-21111	No Parking	12 x 9"	18 x 97"	\$90	\$85
S-21112	Fire Lane		18 x 86"		
S-21113	Handicap Symbol	39"	48 x 40"	95	90

- Heavy-duty 1/8" plastic for professional results.
- Flexible. Conforms to uneven surfaces.
- For use with spray or brush-on paint.



Additional messages, see [uline.com](http://uline.com)

# GALVANIZING SPRAY

New



Improves rusty metal sign posts, fences and railings.

- Prevents rust and corrosion.
- Cold – For a subtle matte finish.
- Brite – For a polished glossy finish.

MODEL NO.	DESCRIPTION	COLOR	ZINC	SIZE	QTY./CTN.	PRICE PER CAN	
						2	6+
S-25169	Cold	Gray	93%	13 oz.	12	\$16	\$14
S-25170	Brite		65%			18	16

Min. 2

# CHICKEN WIRE

New

Protect trees, flowers and gardens from curious critters and pesky rodents.

- Easily cuts to size with tin snips.
- 1/4" – Protects against rabbits and squirrels.
- 1/2" – For containment fencing and rebar.



### CORROSION RESISTANT

MODEL NO.	DESCRIPTION	SIZE H x L	WT. (LBS.)	PRICE EACH	
				1	3+
S-25196	1/4" Chicken Wire	3 x 50'	23	\$120	\$115
S-25197	1/2" Chicken Wire		26	110	105

# HEAVY-DUTY BASES



30 LB. BASE



60 LB. BASE



60 LB. W/ WHEELS

Wind, sleet or snow won't knock these over.

- Use with PVC or U-Channel Sign Posts.

**H-9495** – Tip and roll. Durable 5" wheels roll over uneven terrain.

Signs, see page 731



MODEL NO.	SIZE L x W x H	DESCRIPTION	PRICE EACH		
			1	3	5+
H-4588	18 x 18 x 3"	30 lb. Base	\$85	\$83	\$81
H-4589	18 x 18 x 6"	60 lb. Base	150	147	145
H-9495	20 x 21 x 6"	60 lb. Base w/ Wheels	180	175	170

# HARD HATS

## STANDARD



LIME



YELLOW



WHITE



Pink



Red



Orange



Gray



Blue



Green



Black

Heavy-duty hard hats to wear on the job.

- Adjustable suspension for a custom fit.
- Includes washable sweatband.

Meets ANSI Z89.1-2014

SPECIFY COLOR

Sold in Packs of 12

MODEL NO.	DESCRIPTION	ADJUSTMENT STYLE	PRICE EACH
S-10512	Standard	Ratchet	\$10

MODEL NO.	DESCRIPTION	PRICE EACH
S-15378	Replacement Sweatband	\$16

## VENTED



Beat the outdoor heat all day long.

- 8 cooling vents increase airflow for your comfort.
- 4-point ratchet suspension.



Meets ANSI Z89.1-2014 SPECIFY COLOR: White Blue Yellow

MODEL NO.	DESCRIPTION	ADJUSTMENT STYLE	PRICE EACH
S-23045	Vented	Ratchet	\$15

## FULL BRIM



Extra 360° protection from sun, rain and debris.

- Easy adjust for custom fit.
- For construction, road crews and maintenance.



Meets ANSI Z89.1-2014 SPECIFY COLOR: White Yellow

MODEL NO.	DESCRIPTION	ADJUSTMENT STYLE	PRICE EACH
S-14344	Full Brim	Ratchet	\$15

## DELUXE

The Ferrari of hard hats.

- 6-point suspension provides superior safety.
- Recommended for utility workers and tree trimmers.



Meets ANSI Z89.1-2014 SPECIFY COLOR: White Graphite Black

MODEL NO.	DESCRIPTION	ADJUSTMENT STYLE	PRICE EACH
S-24125	Deluxe	Ratchet	\$90

# PVC WORK BOOTS



Rugged outdoor wear for forestry, landscaping and farming.

- Tough PVC outer shell.
- Self-cleaning sole offers secure traction.
- 100% waterproof.

KNEE HIGH – 15" tall

\* Meets ASTM F2413-11

MODEL NO.	DESCRIPTION	MEN'S SIZES	PAIRS/BOX	PRICE PER PAIR	
				1	6+
S-22288	Plain Toe	9-12	6	\$46	\$43
S-23052*	Steel Toe			50	47

# HEADLAMP

Work in the dark. For mechanics, plumbers and electricians.

- Hands-free, 90° swivel, LED lighting.
- Includes head strap and 3 AAA batteries.
- 3 settings: area, flood and spot.



Hard Hat not included

MODEL NO.	DESCRIPTION	RUN TIME	PRICE EACH	
			1	4+
S-21093	Standard	35 hours	\$29	\$27

# QUICK FIT TOE CAPS



Quick, convenient toe protection for visitors and inspectors.

- Steel toe attached to rubbers.
- Rubber strap stretches to fit shoes and heels.

SPECIFY SIZE: S (White), M (Yellow) or L (Red)

MODEL NO.	DESC.	MEN'S SIZES	PRICE PER PAIR	
			1	3+
S-22258	Toe Caps	S (4-7), M (8-10), L (11-14)	\$30	\$28

# SAFETY TOE COVERS

Foot protection for temporary workers and guests on plant tours.

- Steel toe attached to rubbers.
- Complete sole coverage with slip-resistant tread.



SPECIFY SIZE: XS (Gray), S (White), M (Yellow), L (Red), XL (Blue) or 2XL (Green)

MODEL NO.	DESC.	MEN'S SIZES	PRICE PER PAIR	
			1	3+
S-14306	Toe Covers	XS (4-5), S (6-7), M (8-9), L (10-11), XL (12-13), 2XL (13-15)	\$31	\$29



## HIGH-INTENSITY STOP SIGNS



Stop traffic on the long and winding road.

- Two times brighter. Visible from 1,000 feet.
- Corrosion-resistant aluminum with 3M high-intensity prismatic sheeting.

Meets MUTCD and FHWA Standards

MODEL NO.	SIZE W x H	THICKNESS	PRICE EACH		
			1	3	5+
H-5749	24 x 24"	1/12"	\$99	\$94	\$89
H-5750	30 x 30"		124	119	114

## BULLHORNS



H-4744

Command attention! Be loud and clear for outdoor events or crowd control.

- 3 settings: talk, siren, whistle. Adjustable volume control.
- Tough, lightweight, weatherproof ABS plastic.
- Pistol grip talk switch, easy-loading battery cartridge.

Batteries sold separately, see page 636

MODEL NO.	MAXIMUM RANGE	POWER (WATTS)	BATTERIES REQUIRED	WT. (LBS.)	PRICE EACH	
					1	2+
H-4743	1/2 Mile	20	6 C	2	\$205	\$200
H-4744	1 Mile	25	8 C		245	240

## AIR HORN



Alert employees up to 1/2 mile away.

- Blast over machinery and industrial noise.
- Portable signaling system strength is 120 dB at 10 feet.

MODEL NO.	DESCRIPTION	MAXIMUM RANGE	QTY./CASE	NET OZ.	PRICE PER CAN	
					1	12+
S-13530	Can and Horn	1/2 Mile	6	8	\$18	\$16
S-13531	Refill		12		15	13

## FLEET SAFETY KIT

Accidents happen. Keep drivers safe during emergencies.



- Meets CFR49 requirements.
- Sturdy metal case stows behind cab.
- Includes: (3) 20-minute flares, (3) warning triangles, (1) 2½ lb. fire extinguisher and (1) hold-down strap.

\* Meets FMVSS-125 Standards

MODEL NO.	DESCRIPTION	PRICE EACH	
		1	3+
H-6137	8-Piece Fleet Safety Kit	\$205	\$195
H-2589*	3 Warning Triangles	37	35

## BIG BOY SIGN BASE

Sturdy base stands up to gale-force wind, sleet and snow.

- HDPE plastic won't rust or crack.
- Fill with water or sand.
- Post included. 7 pre-drilled holes. Includes mounting hardware.
- Recessed wheels roll easily.



6' Post

SPECIFY COLOR: Yellow or Black

MODEL NO.	SIZE H x W	SHPG. WT.	PRICE EACH	
			1	5+
H-9309	6' x 24"	17 lbs.	\$205	\$195

Signs sold separately

## WATER-WALL™



PRIVACY SCREEN

## FENCE PANEL/PRIVACY SCREEN

Provide additional security and privacy in work zones.

- Durable 11-gauge steel chain link fence panel.
- Easy to install. Pins slide into Water-Wall™ Barrier's interlocking joints. Increases overall height to 84".

Privacy Screen – Cover fences for privacy and wind protection. Easily attaches with included cable ties.



FENCE PANEL

MODEL NO.	DESCRIPTION	SIZE L x H	WT. (LBS.)	PRICE EACH	
				1	4+
H-9290	Fence Panel	72 x 48"	27	\$385	\$360
S-24104	Privacy Screen	64 x 48"	2	40	35

Water-Wall™ Barrier sold separately, page 734

■ SHIPS VIA MOTOR FREIGHT

# PARKING AND TRAFFIC SIGNS



Clearly designate parking areas and safely control traffic.

- Reflective engineer-grade finish for day/night visibility.
- Corrosion-resistant aluminum lasts for 5 to 7 years.
- Pre-drilled for fast, easy mounting. Hardware included.

Meets MUTCD Standards

MODEL NO.	SIZE W x H	DESCRIPTION	THICKNESS	PRICE EACH		
				1	3	5+
H-1658		No Parking				
H-2531		No Parking – Fire Lane				
H-1659	12 x 18"	Reserved Parking	1/12"	\$30	\$28	\$26
H-1660		Visitor Parking Only				
H-1661		Handicapped Parking				
H-2380	18 x 18"			42	39	36
H-2381	24 x 24"	Stop	1/12"	74	69	64
H-5514	30 x 30"			99	94	89

# SQUARE SIGN POSTS

Eliminate the need for multiple posts.

- Signs attach to all four sides.
- Rust-resistant galvanized steel.

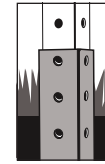
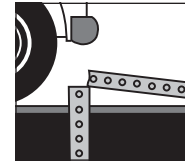

### Optional Anchor Base

- Installs in ground.
- If struck, inside sign post breaks away.
- Simply slide new post into base for quick, easy replacement.



### POSTS

Meets MUTCD Standards

MODEL NO.	SIZE	DESCRIPTION	PRICE EACH		
			1	3	5+
■ H-5515	8 ft.	Square Post	\$70	\$67	\$64
■ H-5516	10 ft.	Square Post	88	84	80
H-5517	3 ft.	Square Anchor Base	45	43	41

### SIGNS

H-3544		Speed Limit 5			
H-3545	12 x 18"	Speed Limit 10	\$30	\$28	\$26
H-5518		Speed Limit 15			
H-5519	24 x 24"	Yield	55	52	49

■ SHIPS VIA MOTOR FREIGHT

# U-CHANNEL POSTS

Heavy-duty steel. Galvanized or green baked enamel finish resists corrosion.

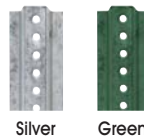

Silver Green

Meets MUTCD Standards

SPECIFY: Galvanized Steel

MODEL NO.	LENGTH	DESCRIPTION	PRICE EACH		
			1	3	5+
H-4585	6 ft.		\$35	\$33	\$31
■ H-1662	8 ft.	U-Channel Post	42	40	38
■ H-4586	10 ft.		55	52	49

■ SHIPS VIA MOTOR FREIGHT

# POST ANCHORS New

Surface mount U-Channel and Square Posts to concrete or asphalt.

- Corrosion-resistant galvanized steel.
- Sign post slips easily into mounted base.

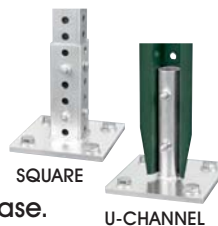

SQUARE

U-CHANNEL

Mounting hardware included

MODEL NO.	SIZE L x W x H	DESCRIPTION	PRICE EACH		
			1	3	5+
H-10494	6 x 6 x 6"	Square Post Anchor	\$85	\$83	\$80
H-10496	6 x 6 x 7"	U-Channel Post Anchor			

# PORTABLE SIGN BASE



Grip, tip and roll. Quickly and easily move signs wherever needed.

- Recessed wheels roll easily over most surfaces.
- Heavy-duty plastic won't rust, dent or crack in cold weather.

4' post with 7 pre-drilled holes. Includes mounting hardware.

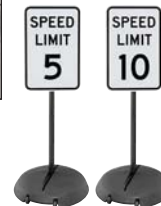

SIGNS SOLD SEPARATELY

MODEL NO.	SIZE H x W	DESCRIPTION	SHPG. WT.	PRICE EACH		
				1	3	5+
H-4592	4' x 24" Diam.	Portable Base	12 lbs.	\$150	\$145	\$140
H-2914	24 x 24"	Do Not Enter Sign	5 lbs.	74	69	64

# FLEXIBLE DELINEATOR POSTS

Rugged plastic post springs back upright after impact.

- Adhere to pavement with 8" butyl pad, sold separately.

**Round** – 3" reflective bands. 360° visibility for high-traffic work zones or walkways.

**Flat Face** – 12" reflective strips on both sides. Increased visibility for 2-way traffic in parking garages or receiving docks.

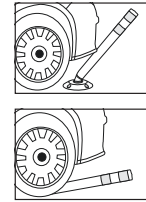

\* SPECIFY COLOR: Orange, White or Yellow

MODEL NO.	HEIGHT	DESCRIPTION	PRICE EACH	
			1	3+
H-4465*	36"	Round Post w/ Base	\$43	\$41
H-4466*	48"		47	45
H-9869*	36"	Flat Face Post w/ Base	47	45
H-9870*	48"		50	48
H-4467	8" Diam.	Butyl Adhesive Pad (.25 lb.)	9	8

Meets NCHRP-350 and MUTCD Standards

**BULK BUY – SAVE UP TO 25%**

Min. 10

MODEL NO.	HEIGHT	DESCRIPTION	PRICE EACH	
			10	40+
H-7959*	36"	Round Post w/ Base	\$33	\$31
H-7960*	48"		36	34
H-9871*	36"	Flat Face Post w/ Base	37	35
H-9872*	48"		40	38

# POP-UP LIGHTED CONES

Pull up for temporary or emergency traffic rerouting.

- Long-lasting LEDs. Up to 100,000 flashes or 36 hours of steady burn.
- Collapses flat for easy storage.

# COLORED CONES

Subtle but seen. Mark driveways to deter unwanted traffic.

- Durable PVC won't fade, dent or crack.
- Stackable. For indoor and outdoor use.



Includes carrying case and 2 batteries

Meets MUTCD Standards

MODEL NO.	DESCRIPTION	HEIGHT	QTY./PACK	PRICE EACH (MIN. 2)		
				2	6	12+
S-21159	Lighted	18"	1	\$27	\$25	\$23
S-15586		28"		40	38	36

SPECIFY COLOR: █ Black █ Red █ Blue █ Yellow

MODEL NO.	DESCRIPTION	HEIGHT	WT. (LBS.)	PRICE EACH (MIN. 2)			
				2	10	25	50+
S-24656	Standard	28"	7	\$27	\$26	\$25	\$23

# LED ROAD FLARES

Mighty powerful. Recommended for truckers, tow truck vehicles and law enforcement.

- Visible up to 1 mile away for up to 60 hours. Crushproof, waterproof.
- 360° viewing angle with 7 flash patterns.



MODEL NO.	DESCRIPTION	LED COLOR	QTY./PACK	PRICE EACH	
				1	2+
H-7931	Magnetic LED Flare Kit	Red	4	\$175	\$165

Meets MUTCD, NFPA and D.O.T. Standards

# PORTABLE SPEED BUMP

Slow traffic to 5-10 mph for special events.

- High-impact polypropylene with rubber backing.
- Rolls up for storage.
- Carrying bag included.



MODEL NO.	DESCRIPTION	DIMENSIONS L x W x H	COLOR	WT. (LBS.)	PRICE EACH	
					1	2+
H-5939	10' Plastic	120 x 9 x 2"	Yellow	23	\$435	\$415

# TRAFFIC SAFETY BATON

Safely direct traffic at special events, in highway construction zones or at airports.

- High-visibility LED lights. Up to 480 hours of run time.
- 3 settings: on, flash, quick flash.



Requires 2 C batteries, not included

MODEL NO.	DESCRIPTION	OVERALL LENGTH	LIGHT LENGTH	PRICE EACH	
				1	3+
H-5190	LED Safety Baton	21"	13"	\$20	\$18



# DELINEATOR POSTS

Weighted post diverts traffic in parking lots.

- Detachable rubber base.
- Molded-in handle for portability.
- **Black** – Preferred by hotels and valet services.
- H-3759 – LED light flashes 60 times per minute for extra safety. Light lasts up to 420 hours. Requires 4 D batteries, not included.



\* SPECIFY COLOR: Orange, Lime, Yellow, White, Black or Blue

MODEL NO.	HEIGHT	DESCRIPTION	PRICE EACH	
			1	3+
H-2391*	45"	Standard Post w/ 10 lb. Base	\$35	\$33
H-3759		LED Post w/ 10 lb. Base	99	95

Meets NCHRP-350 and MUTCD Standards

**BULK BUY – SAVE UP TO 25%**

Min. 6

MODEL NO.	HEIGHT	DESCRIPTION	PRICE EACH	
			6	24+
H-3425*	45"	Standard Post w/o Base	\$15	\$14
H-3424	N/A	10 lb. Hexagonal Base	12	11
H-5491	N/A	16 lb. Hexagonal Base	20	19



# CHANNELIZER CONES

Stackable. Use less space than barricades for road construction.

- Large, loop-top carry handle.
- Impact resistant, low-density polyethylene.
- Detachable rubber base. Reflective – 6" high-intensity bands for visibility.

Meets NCHRP-350, MUTCD and MASH Standards

MODEL NO.	HEIGHT	DESCRIPTION	PRICE EACH	
			1	3+
H-2845	42"	Standard Cone w/ 10 lb. Base	\$41	\$39
H-2846		Reflective Cone w/ 10 lb. Base	63	61

**BULK BUY – SAVE UP TO 40%**

Min. 6

MODEL NO.	HEIGHT	DESCRIPTION	PRICE EACH	
			6	24+
H-3417	42"	Standard Cone w/o Base	\$18	\$17
H-3418		Reflective Cone w/o Base	29	27
H-3416	N/A	10 lb. Hexagonal Base	12	11
H-5492	N/A	16 lb. Hexagonal Base	20	19



# VERTICAL BARRICADES

Keep pedestrians and workers out of harm's way in crosswalks and parking lots.

- Stackable for space-saving storage.
- Rubber Base sold separately.

Meets MUTCD Standards

MODEL NO.	HEIGHT	DESCRIPTION	WT. (LBS.)	PRICE EACH	
				1	3+
H-5176	44"	Traffic Panel	4	\$46	\$43
H-9887		Valet Parking Panel		55	50
H-5177		Crosswalk Panel		135	125
H-5178	N/A	Rubber Base	20	29	27

**Traffic** – High intensity for work zones and construction sites.

**Valet** – Let hotel and restaurant guests know you'll take care of their car.

**Crosswalk** – 3M Diamond Grade® material for maximum visibility.



# TRAFFIC PADDLES

Must-have for crossing guards, road crews and parking attendants.

- Double-sided – Stop and Slow.
- Engineer-grade reflective sheeting with 9" poly-grip handle. 6" lettering height.

Meets MUTCD Standards

MODEL NO.	DESCRIPTION	SIGN SIZE W x H	WT. (LBS.)	PRICE EACH	
				1	3+
H-4587	Handheld	18 x 18"	2	\$52	\$49

Pole-Mounted Traffic Paddles available, see [uline.com](http://uline.com)



# SAFETY BARRICADES



## TRAFFIC BARRIERS

Protect construction areas and direct traffic flow.

- High-density polyethylene with UV protection.
- Reflective safety strips help drivers in low light conditions.
- Interlocking joints allow user to form a continuous barricade.
- Fill with sand or water for added stability.

MODEL NO.	DESCRIPTION	SIZE L x W x H	WT. EMPTY (LBS.)	WT. FILLED (LBS.)	PRICE EACH	
					1	4+
H-4583	Traffic Barriers	60 x 16 x 24"	36	594	\$255	\$240
H-4584		72 x 16 x 35"	58	875	419	399

SHIPS VIA MOTOR FREIGHT

## WATER-WALL™ BARRIER

1,100 lbs. of water-filled strength for roads and highways.

- Forkliftable in two places for fast, easy setup and removal.
- Rugged polyethylene. Fill with sand or water.
- Interlocking hinge pivots 30° for continuous, curved barrier.

SPECIFY COLOR: Orange or White

MODEL NO.	DESCRIPTION	SIZE L x W x H	WT. EMPTY (LBS.)	WT. FILLED (LBS.)	PRICE EACH	
					1	4+
H-6717	Water-Wall™	72 x 18 x 32"	80	1,100	\$480	\$460

Meets MASH Standards

SHIPS VIA MOTOR FREIGHT

## CROWD CONTROL BARRIERS



Pedestrian barrier for concerts, sporting events and parades.

- Tamper-resistant, interlocking connections stay secure.
- Easy setup. Weighted feet fold in for flat storage. Portable.
- Adjusts to curbs and uneven surfaces. Lightweight polyethylene.

SPECIFY COLOR: Orange or White

MODEL NO.	DESCRIPTION	SIZE L x H	WT. (LBS.)	PRICE EACH		
				1	4+	8+
H-5500	Crowd Control Barrier	79 x 40"	32	\$140	\$130	

SHIPS VIA MOTOR FREIGHT

## TRAFFIC DRUM



Bright orange barrel warns drivers of work zones.

- Lightweight and stackable. Large handle.
- Impact resistant, high-density polyethylene.
- 6" engineer-grade reflective bands for visibility.
- Optional Rubber Base adds stability.

Meets NCHRP-350 and MUTCD Standards

MODEL NO.	DESCRIPTION	HT.	DIAM.	WT. (LBS.)	PRICE EACH		
					1	4	8+
H-4463	Reflective	42"	18"	10	\$64	\$61	\$58
H-4464	Rubber Base			25	37	35	33

SHIPS VIA MOTOR FREIGHT

## A-FRAME BARRICADE



Lightweight crowd control for parking garages or school lots.

- Won't crack or splinter. Rugged polyethylene.
- Build a single or double style barricade.
- Reflective on both sides.

Easy to assemble – ships and stores flat

Meets MUTCD Standards

MODEL NO.	DESCRIPTION	DIMENSIONS H x W	WT. (LBS.)	PRICE EACH		
				1-2	4	8+
H-6131*	A-Frame Leg	40 x 29"	6	\$35	\$33	\$31
H-6132	6' I-Beam	8 x 72"	5	49	47	45
H-6133	8' I-Beam	8 x 96"	7	63	61	59

\*Min. 2

SHIPS VIA MOTOR FREIGHT



H-2881

## BARRICADE

Direct traffic around temporary hazards and work zones.

- Easily folds to 2½" thick to minimize storage space.
- Highly reflective striping on top panel.
- Built-in bracket supports adding a barricade light.

Meets MUTCD Standards

MODEL NO.	DESCRIPTION	HT.	WT. (LBS.)	PRICE EACH	
				1	3+
H-2882	Type 1 Barricade	44"	14	\$71	\$69
H-2881	LED Barricade Light	N/A	2	37	34

# TRAFFIC CONES

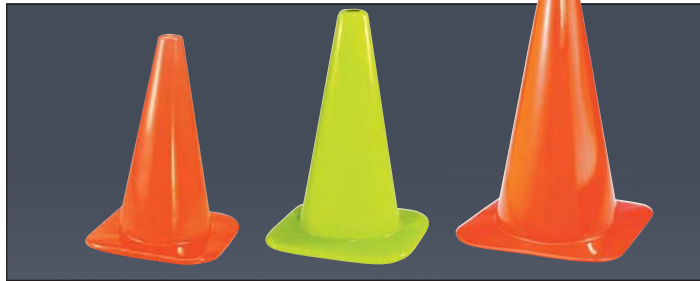

## STANDARD

Reroute traffic as needed. Use indoors or outdoors.

- Durable PVC. Superior stability.
- Stackable.

SPECIFY COLOR: Lime or Orange

MODEL NO.	HEIGHT	WT. (LBS.)	PRICE EACH (MIN. 2)			
			2	10	25	50+
S-19289	6"	1	\$10	\$9	\$8	\$7
S-13529	12"	2	12	11	10	9
S-7877	18"	3	14	\$11 each any quantity		
S-7879	28"	7	23	22	21	20
S-14708	36"	10	32	31	29	27



## REFLECTIVE

3M reflective collars alert drivers in low light conditions.

- Meets MUTCD nighttime requirements.

SPECIFY COLOR: Lime or Orange

MODEL NO.	HEIGHT	WT. (LBS.)	PRICE EACH (MIN. 2)			
			2	10	25	50+
S-14709	18"	3	\$21	\$20	\$19	\$18
S-12188	28"	7	31	\$27 each any quantity		
S-14710	36"	10	39	38	36	34

## HEAVY DUTY

From Alaska to the Great Plains, stays put in the windiest weather.

- 3M reflective collars won't peel off.

SPECIFY COLOR: Lime or Orange

Meets MUTCD Nighttime Requirements

MODEL NO.	HEIGHT	WT. (LBS.)	PRICE EACH (MIN. 2)			
			2	10	25	50+
S-21633	18"	3	\$24	\$23	\$22	\$21
S-21634	28"	10	35	34	32	30
S-21635	36"	12	42	\$37 each any quantity		



## ACCESSORIES

### BAR

MODEL NO.	DESCRIPTION	EXPANDABLE RANGE	PRICE EACH	
			1	4+
S-20274	PVC Traffic Cone Bar	5 - 8'	\$39	\$36

CART – Easily transport cones on 10" wheels

MODEL NO.	DESCRIPTION	SIZE H x W x D	WT. (LBS.)	PRICE EACH	
				1	3+
H-5507	Steel Cone Cart	45 x 16 x 17"	32	\$215	\$200

Bar – Instant barricade for worksites, parking lots and walkways.

- Reflective – 4" high-intensity bands.
- 4 1/4" loops fit over any size Traffic Cone.



## CONE TOPPER BARRIER



Create a quick barricade around manholes, broken concrete and spills.

- 2" retractable nylon belt connects to other Cone Toppers.
- Hook up to 3 additional barriers.
- Easily slides on top of 36" Traffic Cones, sold separately.

\* SPECIFY COLOR: Lime or Orange

MODEL NO.	DESCRIPTION	EXPANDABLE RANGE	PRICE EACH (MIN. 2)	
			2	4+
S-21636	Traffic Cone Belt	10 ft.	\$47	\$45
S-21635*	36" Heavy Duty Reflective Traffic Cone		2/\$42	10+/\$37

## TRAFFIC CONE SIGNS

Turn any cone into a temporary, portable sign.

- Used in parking lots, construction and for special events.
- Easily attaches to standard PVC cones, sold separately.
- Made of UV-resistant plastic.



MODEL NO. / DESCRIPTION		SIZE H x W	PRICE EACH	
			1	3+
H-5508	Lot Full	11 x 13"	\$21	\$19
H-5509	Do Not Enter			
H-5510	Reversible Arrow			
H-5511	No Parking			



# ROLL-UP TRAFFIC SIGNS



Super-sized 48 x 48" "Big Suckers" alert drivers of work areas and hazards.

- Set up in minutes. Roll up for easy storage.

Signs – Super bright Reflexite™ vinyl material is visible day or night.

Stand – Heavy-duty 21 lb. stand holds sign 12" off ground even in very windy conditions.



Meets NCHRP-350 and MUTCD Standards

MODEL NO.	DESCRIPTION	MODEL NO.	DESCRIPTION	PRICE EACH		
				1	3	5+
H-5493	Road Work Ahead	H-5495	Flagger Symbol	\$185	\$175	\$165
H-5494	Men Working Symbol	H-5496	Work Area Ahead			
H-5497	Roll-up Sign Stand	1 / \$245	3 / \$230	5+ / \$215		

# STACKABLE TRAFFIC BARRIER



Temporarily restrict access in parking lots and maintenance areas.

- Nestable to save storage space and transport easily.
- Interlocking joints allow user to form a continuous barrier.
- Built-in handle for quick, one-person setup and takedown.
- UV treated, high-density polyethylene. Fill with sand or water.



MODEL NO.	DESCRIPTION	SIZE L x W x H	WT. EMPTY (LBS.)	WT. FILLED (LBS.)	PRICE EACH	
					1	4+
H-7972	Stackable	78 x 18 x 36"	37	85	\$330	\$320

SHIPS VIA MOTOR FREIGHT

# 90° SWIVEL BARRIER New



Divert traffic around street corners, building restorations and construction zones.

- Twice the weight. Stays put in windy weather and busy roadways.
- Interlocking pin allows barriers to connect and rotate up to 90°.
- Forkliftable in two places for easy setup and removal.
- Rugged, UV resistant polyethylene. Fill with sand or water.

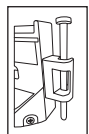

SPECIFY COLOR: Orange or White

MODEL NO.	DESCRIPTION	SIZE L x W x H	WT. EMPTY (LBS.)	WT. FILLED (LBS.)	PRICE EACH	
					1	4+
H-10714	90° Swivel Barrier	72 x 24 x 36"	70	790	\$465	\$445

Meets MASH Standards

SHIPS VIA MOTOR FREIGHT

# STRIPING PAINT AND MACHINE

Parking lots need fresh striping every year. Long lasting solvent paint.

- Dries incredibly fast, traffic-ready in 30 minutes.

Striping Machine – Accurate, clean lines in one coat.

- Line widths adjust 2-4".
- Steel frame with heavy-duty 7" rubber wheels.
- Storage tray holds 12 cans.



SOLD IN CARTON QUANTITIES SPECIFY COLOR: Blue, Yellow, White, Red or Black

MODEL NO.	DESCRIPTION	SIZE	QTY./CTN.	PRICE PER CAN		
				6	12	24+
S-21133	Inverted Striping Paint	18 oz.	6	\$9.50	\$9.00	\$8.50
S-22066	Striping Paint	1 Gal.	2	2/\$47 ea.	6+/\$43 ea.	
H-5640	Striping Paint Machine			\$170 ea. 2+/\$160 ea.		



## SAFETY FENCES

Control pedestrian and vehicle traffic around temporary hazards.

- Recommended for construction sites, parking lots or warehouses.
- Easy to install and remove. Rolls up for easy transport.

**Heavy Duty** – 50% stronger for windy, snowy winter conditions.



**Fence Posts** – Sturdy painted steel for in-ground use. Heavy duty to withstand strong winds.

MODEL NO.	DESCRIPTION	SIZE	FOR USE WITH	PRICE EACH (MIN. 3)		
				3	12	24+
H-9484	Fence Post	6'	4' Tall Fence	\$14	\$13	\$12
H-9310		8'	6' Tall Fence	18	17	16

FENCE		SPECIFY COLOR: Orange Green Black Yellow				
MODEL NO.	DESCRIPTION	SIZE H x L	THICKNESS (MIL)	PRICE EACH		
				1	3	12+
S-14713	Standard	4 x 100'	10	\$42	\$41	\$40
S-22226	Heavy Duty		20	50	49	48
S-24123	Standard	6 x 100'	10	140	138	135
S-24124	Heavy Duty		20	155	153	150



## PRIVACY SCREENS

Use for job sites and tennis courts.

- Recommended for use as shade cloth, mesh tarp or wind screen.
- UV-resistant HDPE material. Lightweight and durable.
- Easily attaches to chain link fence.
- Grommets 24" apart. Cable ties included.

## STAKE FLAGS

Use for landscaping, sewers, underground utilities and surveying.

- Tough, tear-resistant PVC marking flags.
- Wire stake pushes easily into the ground.
- Withstands high wind and harsh weather.



SPECIFY COLOR: Green or Black

MODEL NO.	DESCRIPTION	SIZE H x L	WT. (LBS.)	PRICE EACH		
				1	3	5+
S-24103	Fence Privacy Screen	44" x 50'	6	\$69	\$64	\$59
S-24629		56" x 50'	7	77	71	66
S-23380		68" x 50'	9	85	80	75
S-24630		92" x 50'	10	100	95	89

SPECIFY COLOR: Fl. Orange, Fl. Pink, Fl. Lime, Red, Yellow, Blue, White, Orange, Green or Purple

MODEL NO.	STAKE HEIGHT	FLAG DIM. L x W	FLAG THICKNESS	QTY./ BNDL.	PRICE PER BUNDLE	
					2	10+
S-16061	21"	2½ x 3½"	4 mil	100	\$12	\$11
S-21660		4 x 5"			13	12



## WINDSOCK

Essential safety item for airports, manufacturers and chemical plants.

- Weatherproof, PVC-coated nylon. Double-stitched seams.
- Kit includes windsock, aluminum frame and 10 cable ties.
- OSHA compliant.
- Withstands winds up to 70 mph.

MODEL NO.	DESCRIPTION	SIZE DIAM. x L	PRICE EACH	
			1	3+
H-5985	Windsock Kit	18 x 48"	\$90	\$85
S-21384	Replacement Windsock		47	45

Frame mounts to 1½" pipe, not included



## MARKING PAINT AND WAND

Bright, easy-to-see lines for surveying, utilities, construction and landscaping.

- Use on concrete, grass, brick and asphalt.
- Temporary, water-based paint. Dries in less than 5 minutes.

**Marking Wand** – Spray paint without bending over.

- Lightweight metal frame with 3" plastic wheel.

\*SPECIFY COLOR: White Orange Red Yellow Blue Green Pink

MODEL NO.	DESCRIPTION	SIZE	QTY./ CTN.	PRICE PER CAN	
				12	24+
S-21641*	Rust-Oleum® Marking Paint	17 oz.	12	\$8.50	\$8.00
H-6158	Marking Wand			\$57 ea.	2+/\$55 ea.



# PARKING STOPS



H-2309

End concrete crumbling and chipping forever.

- Made of recycled material.
- Maintenance free. No painting.
- Weather resistant. Impervious to sunlight and road salt.

Plastic – 75% lighter than concrete. Blue for handicapped parking.

Rubber – Conforms to uneven surfaces. Reflective stripes.

PLASTIC		SPECIFY COLOR:  Blue  Yellow  White  Gray				INSTALLATION KITS				
MODEL NO.	DESCRIPTION	DIMENSIONS L x W x H	QTY./SKID	WT. (LBS.)	PRICE EACH		SKID LOT	MODEL NO.	DESCRIPTION	PRICE EACH
					1	5+				
H-2309	6' Plastic	72 x 6 x 3"	30	20	\$75	\$70	\$58	H-2311 H-2310	Concrete Asphalt	\$15
RUBBER		SPECIFY COLOR: Black/Yellow, Black/White or Blue/White				INSTALLATION KITS				
H-4608	6' Rubber	72 x 6 x 4"	49	34	\$70	\$65	\$52	H-2397 H-2396	Concrete Asphalt	\$15



H-4608

# SPEED BUMPS



H-4609

Keep that parking lot safe. Reduce speeds to 5-10 mph.

- Recommended for parking lots, business entrances and warehouse dock areas.
- Can be removed for snow removal.

Plastic – Semi-flexible and lightweight. Safety yellow.

Rubber – Flexible and shock absorbing. Highly reflective for night visibility.

Deluxe Rubber – Taller than standard bumps. Brings traffic to an abrupt halt.

PLASTIC						INSTALLATION KITS			
MODEL NO.	DESCRIPTION	DIMENSIONS L x W x H	COLOR	WT. (LBS.)	PRICE EACH		MODEL NO.	DESCRIPTION	PRICE EACH
					1	5+			
H-4609	6' Plastic	72 x 10 x 2"	Yellow	23	\$130	\$120	H-4611 H-4612	Concrete Asphalt	\$29
RUBBER						INSTALLATION KITS			
MODEL NO.	DESCRIPTION	DIMENSIONS L x W x H	COLOR	WT. (LBS.)	PRICE EACH		MODEL NO.	DESCRIPTION	PRICE EACH
					1	5+			
H-6423	4' Rubber	48 x 12 x 2"	Yellow/Blk	32	\$120	\$110	H-2397 H-2396	Concrete Asphalt	\$15
H-2394	6' Rubber	72 x 12 x 2"	Yellow/Blk	51	180	170			
H-2395	End Cap	9 x 12 x 2"	Black	6	37	31			
DELUXE RUBBER						INSTALLATION KITS			
MODEL NO.	DESCRIPTION	DIMENSIONS L x W x H	COLOR	WT. (LBS.)	PRICE EACH		MODEL NO.	DESCRIPTION	PRICE EACH
					1	5+			
H-5512	6' Deluxe	72 x 12 x 3"	Yellow/Blk	76	\$215	\$205	H-2397 H-2396	Concrete Asphalt	\$15
H-7932	End Cap	9 x 12 x 3"	Black	8	40	35			



H-2394



H-5512

# PEDESTRIAN CABLE PROTECTORS

**DROP OVER**



Shield cables and cords at trade shows, festivals and concerts.

- Industrial polyurethane resists oil and abrasions. Textured surface for maximum traction.
- Single channel protection. Open bottom.
- Interlocking connectors.

SPECIFY COLOR: Orange or Black

MODEL NO.	CHANNEL SIZE W x H	SIZE L x W x H	WT. CAP. (LBS.)	PRICE EACH	
				1	3+
H-8490	1½ x 1/2"	36 x 5 x 1"	2,100	\$55	\$50
H-8491	4 x 1"	36 x 11 x 2"		110	105



# CABLE PROTECTORS

INDOOR AND OUTDOOR USE

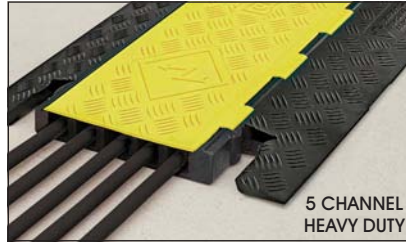
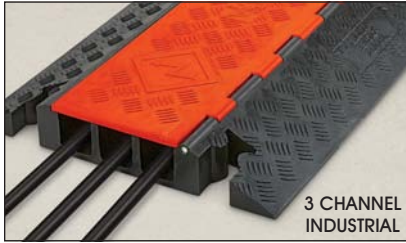

## 3 CHANNEL

MODEL NO.	DESCRIPTION	CHANNEL DIAMETER	SIZE L x W x H	WT. CAP. (LBS.)	PRICE EACH	
					1	3+
H-6954	Industrial	2 1/4"	36 x 20 x 3"	28,420	\$380	\$365
H-6955	Heavy Duty	2 5/8"	36 x 18 x 3"		425	405

## 5 CHANNEL

H-4618	Industrial	1 1/3"	36 x 20 x 2"	21,000	\$280	\$270
H-5501	Heavy Duty				320	305

## DROP OVER

SPECIFY COLOR: Orange or Black

H-4616	Drop Over	1 1/4"	36 x 12 x 2"	23,400	\$230	\$220
H-4617		2 1/4"	36 x 14 x 3"	17,000	300	290

Protect cables from foot traffic and vehicles at golf, charity and sporting events.

- Industrial all-weather polyurethane resists oil and abrasions.

- Textured surface. Interlocking connectors.

3 and 5 Channel – Full top and bottom protection. Hinged lid.



Drop Over – Heavy duty, single channel protection. Open bottom.



# SPEED HUMPS

These are 3 times wider than a standard speed bump.

- Recommended for schools, hospitals, parks and parking lots.
- Interlocking rubber sections won't chip, break or crack.
- Molded-in reflective tape for maximum visibility.

End Caps – Add smooth, finished look.

Installation hardware included

MODEL NO.	DESCRIPTION	DIMENSIONS L x W x H	COLOR	WT. (LBS.)	PRICE EACH	
					1	5+
H-4613	36" Center Section	20 x 36 x 2"	Yellow/Blk	33	\$125	\$115
H-4614	Female End Cap		Black	32	115	105
H-4615	Male End Cap					



Slows traffic to 10-15 mph

# MINI PARKING STOP

Provide space efficient and organized parking areas.

- Recommended for warehouses, garages and carports.
- Conforms to uneven surfaces. Indoor or outdoor.
- Just set in place. No installation required.

MODEL NO.	DESCRIPTION	DIMENSIONS L x W x H	QTY./SKID	WT. (LBS.)	PRICE EACH		SKID LOT
					1	5+	
H-5639	22" Rubber	22 x 6 x 4"	120	9	\$33	\$31	\$26

Parking Stops, see page 738



# CLEARANCE BAR

Alert drivers to low clearance in parking garages and drive-thru lanes.

- High-density polyethylene resists strong impacts and fading.
- Customize for any height with adhesive vinyl graphics kit. Includes "CLEARANCE," two sets of numbers and two eyehooks.

MODEL NO.	DIAMETER	LENGTH	WT. (LBS.)	PRICE EACH	
				1	2+
H-6959	4 1/2"	80"	13	\$170	\$160

- Reflective tape bands increase visibility.



Kit includes numbers to customize height

# ANTI-STATIC ULINE AIR

## CUSHION AND PROTECT STATIC SENSITIVE PRODUCTS

**ULINE AIR** – Economical Uline bubble is ideal for short ship cycles. S-5902: Large 1/2" bubble for extra cushioning.

**ULINE AIR PLUS** – Heavy-duty nylon barrier bubble for long ship or storage cycles.



S-5270



S-396

### ULINE AIR MEETS FED. SPEC. CID-A-A-549E

MODEL NO.	BUBBLE SIZE	ROLL SIZE	LBS./CTN.	PRICE PER CARTON			
				1	3	6	10+
S-5270	3/16"	12" x 175'	5	\$35	\$34	\$32	\$30
S-5271	5/16"	12" x 170'	6	48	46	44	41
S-5902	1/2"	24" x 75'	7	44	41	39	37

### ULINE AIR PLUS MEETS FED. SPEC. PPP-C-795D CLASS 2

MODEL NO.	BUBBLE SIZE	ROLL SIZE	LBS./CTN.	PRICE PER CARTON			
				1	3	6	10+
S-396	3/16"	12" x 175'	5	\$49	\$46	\$43	\$39
S-3953	3/16"	24" x 175'	10	98	91	84	76
S-2314	5/16"	12" x 170'	7	61	57	50	46



# ANTI-STATIC BUBBLE BAGS

**SELF-SEAL**

Provides maximum protection against static discharge for circuit boards, relays, switches, resistors, controls and other sensitive electronic components – Apply your own labels.

- 3/16" industrial bubble coated with a nylon barrier provides outstanding cushioning.
- 1" pressure-sensitive lip covered with release paper allows for easy closing.

### MEETS FED. SPEC. CID-A-A-549E

MODEL NO.	INSIDE W x L	QTY./CTN.	LBS./CTN.	PRICE PER CARTON			
				1	5	10	20+
S-12665	4 x 3½"	1,000	5	\$114	\$109	\$104	\$100
S-500	4 x 5½"	1,000	6	129	124	118	113
S-905	4 x 7½"	500	5	72	69	66	64
S-12666	4 x 10½"	500	7	80	76	72	70
S-14044	6 x 6½"	500	6	105	101	96	92
<b>S-524</b>	<b>6 x 8½"</b>	<b>250</b>	<b>4</b>	<b>\$48 per carton any quantity</b>			
S-2870	7 x 8½"	250	4	81	78	74	71
S-2871	7 x 11½"	500	12	203	194	185	177
<b>S-531</b>	<b>8 x 11½"</b>	<b>450</b>	<b>11</b>	<b>\$120 per carton any quantity</b>			
S-907	8 x 15½"	350	12	145	138	131	126

MODEL NO.	INSIDE W x L	QTY./CTN.	LBS./CTN.	PRICE PER CARTON			
				1	5	10	20+
S-2872	8 x 17½"	250	13	\$160	\$153	\$147	\$141
S-532	10 x 15½"	250	12	132	127	122	117
S-5281	10 x 20"	200	13	105	101	96	92
S-2873	12 x 11½"	250	11	160	153	147	141
S-533	12 x 15½"	200	12	120	114	109	105
S-908	12 x 23½"	150	11	112	107	102	97
S-534	15 x 17½"	150	11	114	109	104	100
S-594	18 x 23½"	100	12	110	105	100	95
S-5282	20 x 20"	100	11	105	101	96	92
S-18399	24 x 24"	75	15	118	112	107	103

# ANTI-STATIC UPSABLE ROLLS

Single rolls are recommended for medium-volume users.

- Provides cushioning and static protection when shipping.
- Industrial-duty bubble has nylon barrier for better air retention.



Perforated every 12 inches

MODEL NO.	BUBBLE SIZE	ROLL SIZE	LBS./ROLL	PRICE PER ROLL			
				1	3	6	10+
S-13053	3/16"	12" x 300'	5	\$47	\$45	\$44	\$43
S-13054		24" x 300'	8	87	83	80	75
S-13055	1/2"	12" x 125'	4	36	34	32	30
S-13056		24" x 100'	7	56	50	47	44

# ANTI-STATIC AIR BUBBLE ROLLS

ORDERS SHIP TODAY

## ULINE INDUSTRIAL

- Light to medium-duty nylon barrier provides dependable, economical protection.
- Ideal for lightweight products with shorter ship cycles.

## BUBBLE WRAP® STRONG

- Heavy-duty nylon barrier for maximum air retention and protection.
- For fragile or valuable products with long ship cycles.

Call Customer Service for information on custom widths and perforations.



### ULINE INDUSTRIAL – FOR LIGHT/MEDIUM DUTY, SHORT SHIP CYCLES

MODEL NO.	BUBBLE SIZE	BUBBLE USE	ROLL SIZE	ROLLS/ BNDL.	LBS./ BNDL.	PRICE PER ROLL (SOLD IN BUNDLE QTYS.)			
						1 BNDL.	2 BNDLS.	3 BNDLS.	4+ BNDLS.
S-1266	3/16"	Electronic Components Spare Parts	12" x 750'	4	28	\$100	\$93	\$87	\$83
<b>S-1266P*</b>			12" x 750'	4		<b>\$83 per roll any bundle quantity</b>			
S-1267			24" x 750'	2		194	183	170	161
<b>S-1267P*</b>			24" x 750'	2		<b>\$161 per roll any bundle quantity</b>			
S-3237			48" x 750'	1		387	364	339	322
<b>S-3237P*</b>	48" x 750'	1	387	364	339	322			
S-2253	5/16"	Semi-Rugged Products	12" x 375'	4	21	62	56	48	45
<b>S-2253P*</b>			12" x 375'	4		62	56	48	45
S-2254			24" x 375'	2		122	107	98	88
<b>S-2254P*</b>			24" x 375'	2		122	107	98	88
S-1268	1/2"	Electronic Instruments Void Fill	12" x 250'	4	19	44	39	37	35
<b>S-1268P*</b>			12" x 250'	4		44	39	37	35
S-2156P*			16" x 250'	3		59	51	47	45
S-1269			24" x 250'	2		87	78	72	68
<b>S-1269P*</b>			24" x 250'	2		<b>\$68 per roll any bundle quantity</b>			
S-3238			48" x 250'	1		173	155	146	135
<b>S-3238P*</b>	48" x 250'	1	173	155	146	135			

\* PERFORATED EVERY 12"

SHIPS VIA MOTOR FREIGHT

### BUBBLE WRAP® STRONG – FOR HEAVY DUTY, LONG SHIP CYCLES

MEETS FED. SPEC. PPP-C-795D CLASS 2

S-397	3/16"	Electronic Components Spare Parts	12" x 750'	4	37	\$113	\$108	\$104	\$97
<b>S-397P*</b>			12" x 750'	4		113	108	104	97
S-398			24" x 750'	2		227	217	206	194
<b>S-398P*</b>			24" x 750'	2		227	217	206	194
S-2602			48" x 750'	1		453	434	411	387
<b>S-2602P*</b>	48" x 750'	1	453	434	411	387			
S-2874	5/16"	Semi-Rugged Products	12" x 375'	4	27	74	69	64	60
<b>S-2874P*</b>			12" x 375'	4		74	69	64	60
S-2875			24" x 375'	2		146	135	126	118
<b>S-2875P*</b>			24" x 375'	2		146	135	126	118
S-5903			48" x 375'	1		290	271	252	234
<b>S-5903P*</b>	48" x 375'	1	290	271	252	234			
S-1913	1/2"	Electronic Instruments Void Fill	12" x 250'	4	21	62	59	56	49
<b>S-1913P*</b>			12" x 250'	4		62	59	56	49
S-1914			24" x 250'	2		122	113	106	98
<b>S-1914P*</b>			24" x 250'	2		122	113	106	98
S-2603			48" x 250'	1		240	225	208	193
<b>S-2603P*</b>			48" x 250'	1		240	225	208	193

\* PERFORATED EVERY 12"

SHIPS VIA MOTOR FREIGHT



## ANTI-STATIC FOAM ROLLS

Nonabrasive, static-free polyethylene foam rolls in economical lengths.

- Custom widths available. **Uline slits and ships within 24 hours.**
- Recommended for use with static-sensitive equipment.

MEETS CID A-A-59135-CLASS 1, GRADE B

SOLD IN BUNDLE QUANTITIES

MODEL NO.	THICKNESS	ROLL SIZE	ROLLS/BNDL.	PRICE PER ROLL (SOLD IN BUNDLES)			WT./BNDL.
				1 BNDL.	2 BNDLS.	3+ BNDLS.	
S-795 S-795P*	1/8"	12" x 550'	6	\$62 62	\$59 59	\$56 56	52 lbs.
S-796 S-796P*		24" x 550'	3	119 119	112 112	106 106	
S-2869 S-2869P*		36" x 550'	2	179 179	169 169	159 159	
S-6697 S-6697P*	1/4"	12" x 250'	6	68 68	65 65	63 63	62 lbs.
S-6680 S-6680P*		24" x 250'	3	131 131	127 127	123 123	

\*PERFORATED EVERY 12"

SHIPS VIA MOTOR FREIGHT

## ANTI-STATIC FOAM

Lightweight, nonabrasive polyethylene foam provides excellent protection from static discharge in shipping.

- Great for circuit boards, resistors and other electronic components.

MEETS CID A-A-59135-CLASS 1, GRADE B

CROSS PERFORATED EVERY 12"

MODEL NO.	THICKNESS	ROLL SIZE	PRICE PER CARTON			WT./ROLL
			1	2	3+	
S-789 S-790	1/8"	12" x 175'	\$40	\$38	\$36	7 lbs.
		24" x 175'	74	69	65	9 lbs.

## ANTI-STATIC FOAM POUCHES

Cushion and protect your static-sensitive products.

- Easy to use. Just insert your circuit board or electronic component.
- Nonabrasive, static-free 1/8" polyethylene foam.

MODEL NO.	THICKNESS	SIZE W x L	QTY./CARTON	PRICE PER CARTON			WT./CARTON
				1	2	5+	
S-15905	1/8"	3 x 4"	500	\$66	\$63	\$60	2 lbs.
S-12581		4 x 6"	500	68	65	62	3 lbs.
S-12583		9 x 12"	150	59	56	50	4 lbs.

## STAINLESS STEEL CABINETS

Lock up expensive lab equipment and corrosive chemicals. Lasts a lifetime.

- Welded, heavy-duty construction stands up to harsh environments.
- Recessed paddle lock handle. Full-height hinges for smooth closure.

SHIPS ASSEMBLED VIA MOTOR FREIGHT

MODEL NO.	DIMENSIONS W x D x H	WT./ (LBS.)	PRICE EACH	
			1	2+
H-5588	36 x 24 x 73"	260	\$3,140	\$3,015
H-5589	48 x 24 x 73"	310	3,505	3,380

## STATIC SHIELDING ROLLS

Make your own static-shielding bags.

- **Economical** rolls provide the same "Faraday cage" as ready-made bags.
- 4-layer protection.



WITHOUT PRINTING

MODEL NO.	ROLL SIZE W x L	MIL	LBS./ROLL	PRICE PER ROLL		
				1	5	10+
S-12669	24" x 200 yds.		24	\$151	\$142	\$134
S-6272	36" x 200 yds.	2.9	36	224	212	200
S-12670	48" x 200 yds.		48	299	282	266

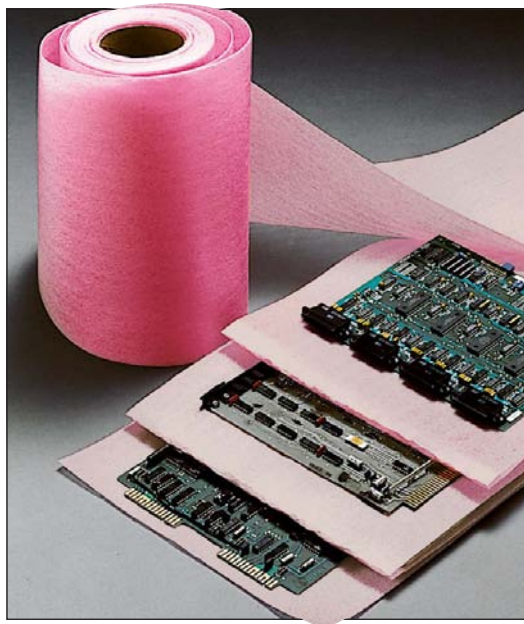

# STATIC SHIELDING BAGS

## RECLOSABLE

Secure static-sensitive items quickly with double-track zipper closure. Ideal for intercompany transfers.

- Same "Faraday cage" protection as open-end bags.
- 3 mil transparent metallic film.
- 4-layer protection guards against charges inside and out.
- MEETS THE REQUIREMENTS OF MIL-STD-3010 4046, EIA 541, EIA 625 AND ANSI/ESD S20.20.

Reclosable and open end static shielding bags have 4-layer protection.

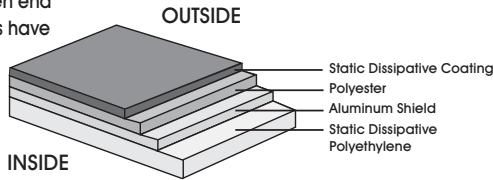

MODEL NO.	INSIDE W x L	PRICE PER CARTON OF 100				LBS./CTN.
		1	5	10	20+	
S-5083	2 x 3"	\$15	\$14	\$13	\$12	1
S-7651	2 x 6"	19	18	17	16	1
S-5084	3 x 3"	16	15	14	13	1
<b>S-2506</b>	<b>3 x 5"</b>	<b>\$14 per carton any quantity</b>				<b>1</b>
S-5085	4 x 4"	18	17	16	15	2
S-7623	4 x 5"	20	19	18	17	2
<b>S-2261</b>	<b>4 x 6"</b>	<b>\$18 per carton any quantity</b>				<b>2</b>
S-5304	4 x 7"	24	23	22	21	2
S-5086	4 x 8"	26	25	24	23	2
S-5087	4 x 24"	54	51	48	46	4
S-6373	5 x 5"	23	22	21	20	2
S-5306	5 x 7"	26	25	24	23	2
S-3447	5 x 8"	27	26	25	24	2
S-5088	5 x 10"	35	32	30	29	3
S-7624	6 x 6"	28	26	25	24	2
<b>S-2262</b>	<b>6 x 8"</b>	<b>\$26 per carton any quantity</b>				<b>2</b>
S-2507	6 x 10"	36	33	31	30	3
S-5090	6 x 30"	81	77	71	69	6

MODEL NO.	INSIDE W x L	PRICE PER CARTON OF 100				LBS./CTN.
		1	5	10	20+	
S-7652	7 x 10"	\$42	\$40	\$38	\$36	3
S-5091	7 x 15"	47	44	41	39	4
S-5092	8 x 8"	40	37	35	33	3
<b>S-2263</b>	<b>8 x 10"</b>	<b>\$37 per carton any quantity</b>				<b>3</b>
S-2508	8 x 12"	47	44	41	39	4
S-5307	8 x 16"	58	55	53	51	5
S-3753	9 x 12"	57	54	52	50	4
S-6374	10 x 10"	56	53	51	49	4
S-2264	10 x 12"	58	55	53	51	4
S-5309	10 x 13"	63	59	57	55	5
S-2265	10 x 14"	64	61	58	56	5
S-3754	10 x 24"	101	98	94	91	8
S-5094	11 x 15"	70	66	64	62	6
S-5095	12 x 12"	72	68	65	63	6
S-5310	12 x 15"	80	76	70	67	7
S-2509	12 x 16"	80	76	70	68	7
S-2266	12 x 18"	91	87	81	79	8
S-2267	14 x 18"	95	91	87	85	8
S-2268	15 x 18"	106	102	98	95	9
S-12667	15 x 20"	114	111	105	102	9
S-7653	16 x 18"	113	110	104	101	9
S-5096	16 x 24"	140	132	127	123	14
S-3448	18 x 18"	119	114	110	106	11
S-3755	18 x 24"	173	166	159	153	15
S-12668	20 x 20"	175	168	161	155	14
S-16083	20 x 24"	190	183	176	168	14
S-16084	24 x 24"	208	200	192	184	16
S-7654	24 x 30"	240	233	226	219	20

### BULK PACKS – Recommended for high volume users.

MODEL NO.	INSIDE W x L	DESCRIPTION	PRICE/CTN. OF 1,000		LBS./CTN.
			1	5+	
S-5083B	2 x 3"	<b>BULK PACKS</b> <b>Save up to 55%</b>	\$69	\$65	6
S-5084B	3 x 3"		76	72	7
S-2506B	3 x 5"		85	80	7
S-2261B	4 x 6"		99	94	9
S-5306B	5 x 7"		130	124	13
S-2262B	6 x 8"		148	140	16
S-2263B	8 x 10"		231	220	19

NO PRINT



- Recommended for electronics – Apply your own labels.
- **For retail and graphics:** sparkling pouch for your merchandise. • 3 mil.

Self-Seal Glamour Mailers, see page 103.

## STATIC SHIELDING BAGS

MEETS THE REQUIREMENTS OF MIL-STD-3010 4046, EIA 541, EIA 625 AND ANSI/ESD S20.20

MODEL NO.	INSIDE W x L	PRICE PER CARTON OF 100				LBS./ CTN.
		1	3	6	10+	
S-13003	3 x 5"	\$14	\$13	\$12	\$11	1
S-6504	4 x 6"	16	15	14	13	1
S-21822	5 x 8"	19	18	17	16	2
<b>S-6505</b>	<b>6 x 8"</b>	<b>\$18 per carton any quantity</b>				<b>2</b>
S-13004	8 x 10"	39	37	34	32	2
S-6506	8 x 12"	42	39	36	34	3
S-6507	9 x 12"	49	46	43	41	4
S-6508	10 x 10"	47	44	41	39	4
S-13005	12 x 18"	80	78	75	72	6

### RECLOSABLE

<b>S-6509</b>	<b>2 x 3"</b>	<b>\$13 per carton any quantity</b>				<b>1</b>
S-13006	3 x 5"	\$19	\$18	\$17	\$16	1
S-6510	4 x 6"	21	19	18	17	2
S-14182	5 x 8"	31	29	28	26	2
S-6511	6 x 8"	32	30	29	27	2
S-12623	8 x 10"	53	51	48	44	3
S-6512	9 x 12"	61	58	55	51	4
S-7613	10 x 12"	63	60	57	53	4
S-7614	11 x 15"	76	72	68	64	6
S-6514	12 x 12"	77	73	69	65	6
S-21823	12 x 18"	98	93	88	83	6

## MOISTURE BARRIER BAGS



Protect your expensive electronics from moisture and static damage.

- Ideal for packaging surface-mount devices in tray packs, shipping tubes and tape reels.
- Puncture resistant. • MVTR of .035. • 3.6 mil.

Desiccants and Humidity Indicators, see pages 794-795, 798.

## DRI-SHIELD®

MEETS THE REQUIREMENTS OF MIL-STD-3010 4046, EIA 541, EIA 625 AND ANSI/ESD S20.20

MODEL NO.	INSIDE W x L	PRICE PER CARTON OF 100				LBS./ CTN.
		1	3	6	10+	
S-12624	3 x 5"	\$25	\$22	\$20	\$18	2
S-7615	4 x 6"	30	27	25	23	2
S-12625	6 x 8"	40	37	34	31	3
S-25234	6 x 10"	54	51	48	45	2
S-12626	6 x 30"	99	93	88	82	5
S-6497	8 x 10"	62	56	53	49	4
S-6498	10 x 12"	82	73	69	64	5
S-6499	10 x 20"	118	106	99	92	8
S-6500	10 x 30"	154	140	130	121	11
S-14184	12 x 18"	132	120	113	106	8
S-6501	15 x 18"	144	130	122	113	9
S-6502	16 x 18"	149	135	126	117	10
S-6503	17 x 19"	157	143	133	124	11
S-25235	18 x 24"	265	250	240	230	12

## 5-LAYER POUCH



Complete protection from static discharge and rough handling.

- Aluminum "Faraday cage" layer shields product from electrostatic fields inside and outside the bag.
- 3/16" anti-static bubble absorbs shock, dampens vibrations and provides ESD protection.

## STATIC SHIELDING BUBBLE BAGS

### SELF-SEAL

MEETS REQUIREMENT OF EIA 541

MODEL NO.	INSIDE W x L	QTY./ CTN.	PRICE PER CARTON				LBS./ CTN.
			1	3	5	10+	
S-6660	4 x 5"	125	\$109	\$107	\$105	\$101	3
S-7616	6 x 8"	100	142	139	136	132	4
S-6661	8 x 11"	50	99	96	95	93	4
S-7617	9 x 12"	50	149	146	144	139	4
S-6662	12 x 17"	25	94	92	89	86	4
S-6663	15 x 17"	25	117	114	112	108	4
S-6664	18 x 22"	25	179	175	170	165	6



# STATIC SHIELDING BAGS

## OPEN END

Prevent incoming static charges from damaging ESD-sensitive products.

- 3 mil transparent metallic bags for easy content identification.
- Metal "Faraday cage" layer shields products from electric energy inside and prevents static buildup.
- 4-layer protection guards against charges inside and out.

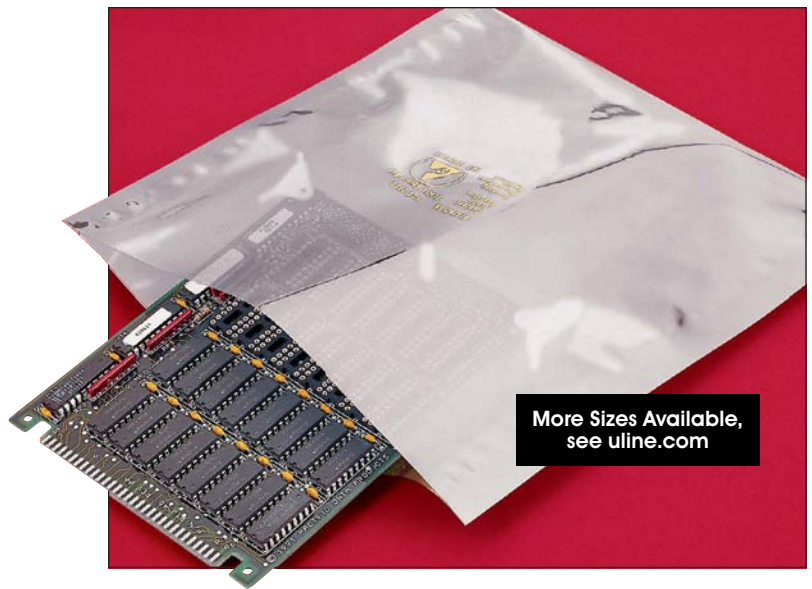

More Sizes Available,  
see uline.com

MEETS THE REQUIREMENTS OF MIL-STD-3010 4046, EIA 541, EIA 625 AND ANSI/ESD S20.20

MODEL NO.	INSIDE W x L	PRICE PER CARTON OF 100				LBS./CTN.
		1	3	5	10+	
S-3725	2 x 3"	\$9	\$8	\$7	\$6	1
S-3726	2 x 4"	10	9	8	7	1
S-6375	2 x 7"	12	11	10	9	1
S-5297	3 x 3"	10	9	8	7	1
S-5886	3 x 4"	11	10	9	8	1
S-1495	3 x 5"	12	11	10	9	1
S-6376	3 x 7"	14	13	12	11	1
S-5298	3 x 10"	18	17	16	14	1
<b>S-1313</b>	<b>4 x 6"</b>	<b>\$10 per carton any quantity</b>				<b>1</b>
S-3444	4 x 8"	16	15	14	13	2
S-3275	4 x 24"	37	34	32	31	4
S-3729	4 x 30"	45	42	40	38	5
S-5077	5 x 6"	16	15	14	13	2
S-3420	5 x 7"	17	16	15	14	2
S-2659	5 x 8"	18	17	16	15	2
S-3421	5 x 10"	20	19	18	16	2
S-5300	6 x 6"	17	16	15	14	2
<b>S-1314</b>	<b>6 x 8"</b>	<b>\$15 per carton any quantity</b>				<b>2</b>
S-3422	6 x 9"	21	20	19	17	2
S-1497	6 x 10"	23	22	21	19	2
S-3276	6 x 12"	27	25	24	23	3
S-3730	6 x 14"	31	29	27	25	3
S-3423	6 x 16"	35	33	32	30	4
S-3733	6 x 30"	63	59	57	54	5
S-3425	7 x 8"	24	23	22	21	2
S-3736	7 x 10"	26	25	24	23	3
S-3427	7 x 15"	37	34	33	32	3
S-3277	8 x 8"	25	23	22	21	3
<b>S-1315</b>	<b>8 x 10"</b>	<b>\$21 per carton any quantity</b>				<b>3</b>
S-2148	8 x 12"	35	32	31	30	3
S-16081	8 x 14"	39	37	36	34	3

### BULK PACKS – Recommended for high volume users.

MODEL NO.	INSIDE W x L	DESCRIPTION	PRICE/CTN. OF 1,000		LBS./CTN.
			1	5+	
S-1495B	3 x 5"	<b>BULK PACKS</b> Save up to 45%	\$49	\$46	7
S-1313B	4 x 6"		66	62	9
S-1314B	6 x 8"		94	89	15
S-1315B	8 x 10"		155	145	23
S-1316B	10 x 12"		220	209	33

MODEL NO.	INSIDE W x L	PRICE PER CARTON OF 100				LBS./CTN.
		1	3	5	10+	
S-3278	8 x 16"	\$42	\$41	\$38	\$36	4
S-3428	8 x 18"	47	44	41	40	5
S-3429	8 x 24"	58	56	53	51	6
S-2660	9 x 12"	39	36	34	33	4
<b>S-1316</b>	<b>10 x 12"</b>	<b>\$33 per carton any quantity</b>				<b>4</b>
S-1498	10 x 14"	46	43	41	39	5
S-3279	10 x 16"	49	47	43	41	5
S-3739	10 x 18"	56	52	49	48	6
S-2945	10 x 24"	71	67	62	58	8
S-3740	10 x 30"	85	83	78	75	9
S-3430	11 x 14"	48	45	42	41	5
S-3445	11 x 15"	49	47	43	42	5
S-3431	12 x 12"	47	44	41	40	5
S-3741	12 x 14"	51	49	47	44	5
S-1317	12 x 15"	54	51	49	47	6
S-2149	12 x 16"	57	53	50	49	6
S-1499	12 x 18"	63	59	57	54	6
S-13002	12 x 20"	70	66	63	59	7
S-3432	12 x 24"	80	76	71	67	8
S-3743	12 x 30"	103	100	95	91	11
S-5885	14 x 16"	66	62	58	54	7
S-2150	14 x 18"	69	66	60	58	7
S-3744	14 x 20"	77	75	68	66	8
S-3745	14 x 30"	120	117	112	108	13
S-1500	15 x 18"	73	69	64	60	8
S-3746	16 x 18"	83	79	74	70	8
S-3747	16 x 20"	96	92	89	84	10
S-3748	16 x 24"	104	100	96	92	11
S-2661	18 x 18"	98	93	90	85	9
S-5079	18 x 20"	108	103	100	94	10
S-2662	18 x 24"	124	118	115	109	12
S-5080	18 x 30"	148	141	136	129	16
S-3446	20 x 20"	115	110	107	102	13
S-5081	20 x 24"	135	127	123	117	14
S-5082	22 x 24"	144	137	131	125	16
S-3749	24 x 24"	150	143	137	130	17
S-3750	24 x 30"	172	166	159	151	18
S-16082	24 x 36"	195	185	176	167	20
S-3751	30 x 24"	172	166	159	151	20
S-25201	36 x 36"	285	275	265	250	30

## ANTI-STATIC RECLOSABLE BAGS

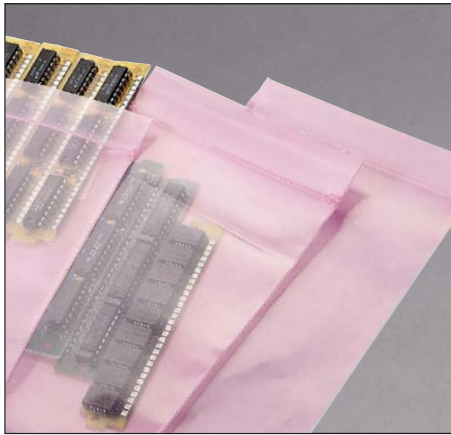

Keep electronic parts free of dust and moisture.

- Heavy duty double-track zipper.
- Polyethylene bags are reusable. Ideal for shipping or storage.

## ANTI-STATIC POLY TUBING



Make your own anti-static bags.

- Excellent resistance to static discharge.
- Static dissipative, noncorrosive pink polyethylene is heat sealable.
- Seal with Poly Tubing Sealers, see pages 154-155.

### 2 MIL

MODEL NO.	INSIDE W x L	LBS./ CTN.	QTY./ CTN.	PRICE PER CARTON		
				1	5	10+
S-13008	2 x 3"	2	1,000	\$22	\$20	\$18
S-12576	3 x 5"	3	1,000	41	37	34
S-12577	4 x 6"	5	1,000	45	42	38
S-18393	4 x 8"	6	1,000	55	51	47
S-12578	6 x 8"	9	1,000	63	60	54
S-14108	6 x 9"	10	1,000	69	65	59
S-13009	8 x 10"	15	1,000	86	80	73
S-12579	9 x 12"	18	1,000	106	96	90
S-14109	12 x 18"	18	500	107	97	91

### 4 MIL

S-3700	2 x 3"	3	1,000	\$51	\$46	\$42
S-1322	2½ x 3"	4	1,000	63	57	52
S-3701	3 x 4"	5	1,000	69	63	57
S-1323	3 x 5"	6	1,000	73	66	60
S-1324	4 x 6"	9	1,000	88	81	73
S-1457	4 x 8"	11	1,000	97	89	80
S-8316	5 x 8"	14	1,000	113	105	96
S-3702	6 x 6"	13	1,000	110	103	93
S-1325	6 x 8"	16	1,000	119	112	101
S-3703	6 x 9"	18	1,000	125	117	107
S-3704	8 x 8"	21	1,000	136	127	117
S-1458	8 x 10"	27	1,000	164	149	136
S-1326	9 x 12"	35	1,000	200	182	167
S-7625	10 x 12"	40	1,000	205	187	171
S-1327	12 x 12"	24	500	127	114	104
S-12580	12 x 15"	29	500	158	145	131
S-8317	12 x 18"	36	500	167	154	140
S-1459	12 x 24"	20	250	128	115	105
S-1460	13 x 18"	36	500	218	199	182
S-3705	15 x 18"	40	500	253	232	210
S-8318	18 x 20"	24	250	167	153	142
S-1461	18 x 24"	30	250	182	170	155
S-3949	20 x 20"	58	500	318	302	270

### 4 MIL

MODEL NO.	ROLL SIZE	LBS./ ROLL	PRICE PER ROLL		
			1	3	6+
S-15328	2" x 500'	4	\$30	\$28	\$26
S-6607	3" x 500'	5	33	31	29
S-1535	4" x 500'	6	38	36	32
S-1536	6" x 500'	10	52	47	43
S-1537	8" x 500'	13	77	71	62
S-3036	10" x 500'	16	93	85	75
S-1538	12" x 500'	19	100	92	82
S-3037	14" x 500'	23	125	113	99
S-3950	16" x 500'	25	155	140	117
S-6608	18" x 500'	27	175	159	139
S-6609	24" x 500'	35	232	208	183
S-6610	32" x 500'	47	299	275	239

### 6 MIL

S-1539	4" x 500'	10	\$57	\$53	\$46
S-1540	6" x 500'	14	78	71	61
S-1541	8" x 500'	19	101	92	79
S-3038	10" x 500'	24	131	118	103
S-1542	12" x 500'	29	148	135	115
S-3039	14" x 500'	34	175	159	137
S-3951	16" x 500'	36	197	178	154
S-6611	18" x 500'	39	223	202	176
S-6612	24" x 500'	52	296	267	230
S-6613	32" x 500'	70	388	348	301

## ANTI-STATIC POLY SHEETING



Create custom packaging for static-sensitive items.

- Heat seal or tape shut.
- Line boxes to protect your entire shipment.

SHIPS VIA UPS

MODEL NO.	ROLL SIZE	MIL	LBS./ ROLL	PRICE PER ROLL		
				1	5	10+
S-14110	24" x 3,000'	1	29	\$115	\$110	\$105
S-9734	48" x 3,000'	1	57	200	195	185
S-13010	48" x 500'	4	35	150	145	140

# ULINE ANTI-STATIC POLY BAGS

Safeguard electronic components from static buildup.

- Anti-static, noncorrosive virgin polyethylene film.
- Heat sealable with Impulse Sealers, pages 154-155.

## 2 MIL

MODEL NO.	INSIDE W x L	LBS./ CTN.	QTY./ CTN.	PRICE PER CARTON		
				1	3	6+
S-7646	2 x 4"	1	1,000	\$22	\$21	\$20
S-6583	3 x 5"	2	1,000	31	29	26
S-5889	4 x 6"	4	1,000	29	26	23
S-6584	5 x 7"	5	1,000	30	28	24
S-21807	5 x 8"	5	1,000	33	31	28
S-5890	6 x 8"	7	1,000	37	33	30
S-6585	6 x 10"	8	1,000	45	40	37
S-5891	8 x 10"	13	1,000	57	53	46
S-6586	9 x 12"	14	1,000	77	69	63
S-13018	10 x 12"	15	1,000	82	72	67
S-7647	10 x 14"	19	1,000	91	85	78
S-12555	10 x 16"	20	1,000	106	99	89
S-6587	12 x 15"	25	1,000	113	103	92
S-6588	12 x 18"	28	1,000	135	123	109
S-7648	18 x 24"	29	500	126	115	102
S-13019	24 x 30"	22	250	103	94	83
S-12556	24 x 36"	29	250	123	112	97

## 4 MIL

MODEL NO.	INSIDE W x L	LBS./ CTN.	QTY./ CTN.	PRICE PER CARTON		
				1	3	6+
S-5251	2 x 3"	2	1,000	\$33	\$31	\$29
S-3713	3 x 5"	4	1,000	61	56	52
S-3714	4 x 6"	7	1,000	45	41	38
S-7649	4 x 8"	9	1,000	75	69	63
S-5252	5 x 7"	9	1,000	62	59	53
S-6592	5 x 8"	10	1,000	64	60	55
S-3715	6 x 8"	13	1,000	78	70	64
S-6593	6 x 9"	14	1,000	99	91	85
S-3716	6 x 10"	16	1,000	91	83	76
S-6594	6 x 12"	18	1,000	118	108	100
S-3717	8 x 10"	22	1,000	112	102	91
S-5254	8 x 12"	26	1,000	135	123	109
S-6595	8 x 16"	33	1,000	173	155	140
S-3718	9 x 12"	29	1,000	144	130	118
S-3719	10 x 12"	32	1,000	158	143	130
S-6596	10 x 14"	36	1,000	185	167	150
S-7650	10 x 16"	22	500	103	93	84



57  
STOCK SIZES

## 4 MIL

MODEL NO.	INSIDE W x L	LBS./ CTN.	QTY./ CTN.	PRICE PER CARTON		
				1	3	6+
S-6597	12 x 12"	37	1,000	\$189	\$171	\$154
S-3720	12 x 15"	24	500	115	106	94
S-3721	12 x 18"	29	500	137	124	112
S-6598	12 x 22"	34	500	167	152	136
S-6599	12 x 24"	37	500	185	168	151
S-6600	14 x 18"	32	500	159	144	130
S-5892	15 x 18"	35	500	176	159	147
S-5255	16 x 20"	42	500	199	183	164
S-5893	18 x 20"	23	250	115	105	93
S-3722	18 x 24"	29	250	140	128	114
S-6601	20 x 24"	31	250	156	143	128
S-21808	24 x 24"	38	250	182	164	147
S-6602	24 x 30"	46	250	231	209	189
S-5256	24 x 36"	23	100	103	93	86
S-6603	26 x 36"	24	100	110	101	90
S-6604	30 x 36"	28	100	126	114	103
S-6605	36 x 36"	33	100	153	137	124
S-12557	36 x 48"	31	75	126	114	103
S-21809	36 x 60"	29	50	128	115	101

## 6 MIL

MODEL NO.	INSIDE W x L	LBS./ CTN.	QTY./ CTN.	PRICE PER CARTON		
				1	3	6+
S-1484	12 x 18"	45	500	\$190	\$174	\$158
S-2944	18 x 24"	42	250	171	162	148
S-3712	24 x 30"	29	100	124	114	105
S-3438	24 x 36"	35	100	144	132	124

## GUSSETED BAGS



Protect computers, monitors or printers.

- Sides expand to fit large, bulky items.
- Use as liners for cartons or bins.
- Virgin polyethylene film.

## 2 MIL

MODEL NO.	SIZE W x D x H	LBS./ CTN.	QTY./ CTN.	PRICE PER CARTON		
				1	3	6+
S-18406	15 x 9 x 24"	38	500	\$160	\$150	\$140
S-18407	24 x 10 x 36"	33	200	130	125	115
S-18408	24 x 20 x 48"	28	100	110	105	95

Heat Sealable

## PALLET COVERS



Protect transformers and servers during shipping.

- Keep moisture and debris off product.
- Large gusseted bags work well as Gaylord liners.

## 2 MIL

MODEL NO.	FITS PALLET L x W x H	COVER SIZE W x D x H	LBS./ ROLL	BAGS/ ROLL	PRICE PER ROLL		
					1	3	6+
S-24184	48 x 40 x 27"	48 x 42 x 48"	49	75	\$175	\$160	\$145
S-24185	48 x 40 x 49"	48 x 46 x 72"	46	50	195	180	165
S-24186	48 x 48 x 48"	51 x 49 x 73"	47	50	210	190	175

Perforated on a roll for easy dispensing



## ESD PROTECTIVE SHIPPERS

Provides total "Faraday cage" protection to ship or store circuit boards.

- Static dissipative, 200 lb. test corrugated with graphite coating.

MEETS REQUIREMENT OF EIA 541

SOLD IN CASE QUANTITIES

MODEL NO.	INSIDE DIMENSIONS	BOXES/CASE	LBS./CASE	PRICE PER SHIPPER		
				6-24	36-48	72+
S-7677	7 x 5 x 1½"	36	8	N/A	\$3.70	\$3.50
S-12738	7 x 5 x 2½"	24	8	\$4.90	4.70	4.40
S-7678	9 x 7 x 2½"	24	13	7.00	6.80	6.40
S-12739	10½ x 8½ x 2½"	24	16	8.00	7.70	7.20
S-7679	12½ x 10½ x 2½"	24	21	10.50	10.10	9.50
S-14113	15¼ x 7½ x 2½"	18	15	11.50	11.00	10.40
S-7680	15½ x 12½ x 2½"	12	15	14.50	14.00	13.10
S-12740	20½ x 15½ x 2½"	6	11	25.50	24.30	23.00

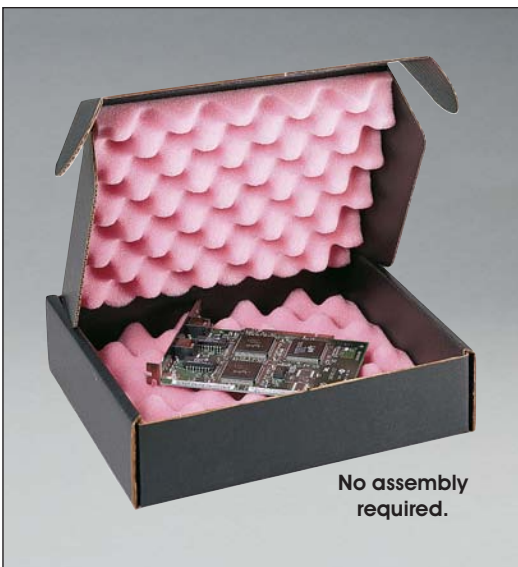

No assembly required.

## MINI ESD COMPONENT SHIPPERS

MEETS REQUIREMENT OF EIA 541

SOLD IN CASE QUANTITIES

MODEL NO.	INSIDE DIMENSIONS	BOXES/CASE	LBS./CASE	PRICE PER SHIPPER		
				1 CASE	3 CASES	5+ CASES
S-25304	2¾ x 2¼ x 1"	100	6	\$2.80	\$2.70	\$2.60
S-25305	3¾ x 3¾ x 1"	100	9	4.10	3.90	3.70
S-25306	7 x 3½ x 1"	50	7	4.70	4.50	4.30



MINI  
7 x 3½"



TINY  
2¾ x 2¼"

Protect your smallest, most fragile components.

- Foam base holds delicate pins in place.

## 3M ANTI-STATIC TAPE

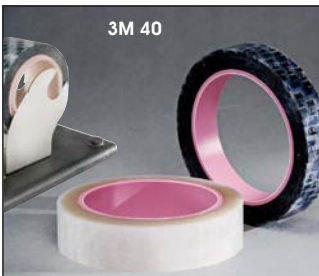

3M 40

Seal static-sensitive bags and packages.

- Prevents damage to sensitive electronics.
- Clear tape with or without printed ESD symbols.

MODEL NO.		SIZE W x L	MIL	ROLLS/CASE	PRICE PER ROLL	
WITH PRINT	NO PRINT				1	9+
S-12747	S-12748	1/2" x 72 yds.	2.2	18	\$31	\$30
S-12749	S-12750	3/4" x 72 yds.		12	46	45
S-12751	S-7164	1" x 72 yds.		9	61	59
S-13037	S-13038	2" x 72 yds.		5	131	126

## ESD TAPE



Mask printed circuit boards during soldering.

- Eliminates static discharge during unwinding and removal.
- Polyimide film with silicone adhesive.

- Maximum temperature 500°F. • 3" core.

MODEL NO.	SIZE W x L	MIL	ROLLS/CASE	PRICE PER ROLL		
				1	4	6+
S-15318	1/4" x 36 yds.	2.6	144	\$14	\$13	\$12
S-15319	1/2" x 36 yds.		72	22	20	19
S-15320	3/4" x 36 yds.		48	31	29	27



## ESD WIRE CART New

Prevent static shock of valuable electronic parts while on the move.

- Recommended for labs, manufacturing and repair shops.
- Conductive casters and 15" drag chain provide constant grounding.
- Adjustable shelf height. • Easy to clean. Won't collect dirt.
- 5" locking swivel casters.



MODEL NO.	OVERALL DIMENSIONS L x W x H	SHELF QTY.	CAP. (LBS.)	WT. (LBS.)	PRICE EACH	
					1	3+
H-10766	48 x 24 x 41"	2	1,000	50	\$340	\$325

SHIPS UNASSEMBLED VIA UPS

# ANTI-STATIC FOAM SHIPPERS

**REUSABLE**

BOX MEETS FED. SPEC. PPP-B-636

SOLD IN CASE QUANTITIES

MODEL NO.	INSIDE DIMENSIONS	BOXES/CASE	LBS./CASE	PRICE PER SHIPPER			
				9-24	48	72	96+
S-5480	5 x 5 x 3"	24	10	\$3.90	\$3.60	\$3.40	\$3.20
S-1406	8 x 8 x 2 3/4"	24	14	8.20	7.30	7.10	6.80
S-5481	9 x 6 x 3"	24	13	6.80	6.40	6.00	5.60
S-2510	10 x 6 x 2"	24	16	6.50	6.00	5.60	5.30
S-3723	10 x 10 x 4"	24	22	11.60	10.70	10.20	9.60
S-1407	12 x 8 x 2 3/4"	24	18	9.60	8.60	8.30	8.00
S-5938	12 x 10 x 2 3/4"	24	20	10.60	9.40	9.00	8.60
S-2511	12 x 12 x 2 3/4"	24	21	11.10	10.40	9.90	9.30
S-3724	12 x 12 x 4"	24	28	13.70	12.50	12.00	11.30
S-1490	14 x 8 x 2 3/4"	24	23	10.20	9.20	8.80	8.40
S-5939*	14 x 12 x 4"	12	14	14.10	12.70	12.30	11.70
S-1491	14 x 14 x 2 3/4"	24	25	12.40	11.40	10.90	10.40
S-1408	16 x 10 x 2 3/4"	24	25	11.60	10.90	10.30	9.80
S-1409	16 x 16 x 2 3/4"	12	17	14.90	13.90	12.90	12.40
S-15327	16 x 16 x 4"	9	14	17.50	16.40	15.50	14.70
S-1492	18 x 12 x 2 3/4"	24	29	13.60	12.40	11.70	11.40
S-2512	18 x 18 x 2 3/4"	12	23	17.50	16.20	15.40	14.80
S-5482	18 x 18 x 4"	9	25	20.60	19.50	18.80	17.50
S-1410	22 x 18 x 2 3/4"	12	27	21.70	20.40	19.80	18.20
S-24191	24 x 10 x 4"	9	19	19.95	18.90	17.90	16.90
S-1494	24 x 24 x 2 3/4"	9	25	26.60	25.10	24.10	22.30
■ S-5483	26 x 18 x 4"	9	30	32.90	31.10	29.80	28.30

■ SHIPS VIA MOTOR FREIGHT

\* S-5939 recommended for laptops



For static-sensitive, fragile shipments.

- Convoluted foam and 200 lb. test corrugated keep products firmly in place.
- Comes assembled with glued foam top and loose bottom.

## CUSTOM SHIPPERS AND FOAM SHEETS

- Shippers – 3 week lead time. One-time die charge.
- Foam sheets – Other colors and thicknesses available. 2 week lead time.



# CONVOLUTED FOAM SETS

SOLD IN CARTON QUANTITIES

MODEL NO.	SHEET SIZE	TYPE OF FOAM	SETS/CTN.	LBS./CTN.	PRICE PER SET	
					1 CTN.	3+ CTNS.
S-18409	10 x 10 x 2"	Anti-Static	24	6	\$3.80	\$3.50
S-5484	12 x 12 x 2"		24	8	5.20	4.80
S-5485	16 x 16 x 2"		12	7	8.10	7.50
S-14163	24 x 24 x 2"		6	8	17.70	16.90
S-1819	24 x 78 x 2"		1	5	58.00	56.00
S-12789	6 x 6 x 2"	Charcoal	64	6	1.25	1.15
S-6435	8 x 6 x 2"		48	5	2.10	1.90
S-11751	10 x 10 x 2"		24	6	2.95	2.75
S-8394	12 x 12 x 2"		24	8	4.10	3.80
S-6436	16 x 16 x 2"		12	7	6.20	5.65
S-6437	24 x 24 x 2"		6	8	12.40	11.65
S-6438	24 x 36 x 2"		9	16	15.65	14.70
S-14641	48 x 96 x 2"		1	11	102.00	95.00



- Cut thick convoluted polyurethane to the size you need.
- Total set height is 2"; base, 3/4".
- Sets are 2 sheets of interlocking foam.

# PLASTIC CONDUCTIVE STACKABLE BINS



Store electronic components, parts and circuit boards.

- Stackable one-piece construction.
- Anti-slide tab prevents shifting when stacked.

SOLD IN CARTON QUANTITIES

MEETS MIL SPEC. MIL-B-81075

MODEL NO.	OUTSIDE DIMENSIONS L x W x H	QTY./ CTN.	LBS./ CTN.	PRICE PER BIN	
				1 CTN.	3+ CTNS.
S-18537	5½ x 4½ x 3"	24	6	\$3.90	\$3.80
S-18538	7½ x 4½ x 3"	24	7	4.60	4.40
S-18539	11 x 5½ x 5"	12	12	14.50	14.20
S-21918	11 x 11 x 5"	6	10	29.00	28.30
S-18540	14¼ x 8¼ x 7"	12	25	24.20	23.50
S-21919	14¼ x 16½ x 7"	6	21	49.00	47.00
S-24190	16 x 11 x 8"	4	12	57.00	55.00
S-7612	18 x 16½ x 11"	3	20	76.00	74.00

# PLASTIC CONDUCTIVE SHELF BINS



Organize and protect small static-sensitive parts on shelves.

- Nestable when empty to save storage space.
- Molded label holder to identify contents.
- Corrugated Conductive Bins, see [uline.com](http://uline.com)

SOLD IN CARTON QUANTITIES

MEETS MIL SPEC. MIL-B-81075

MODEL NO.	OUTSIDE DIMENSIONS W x L x H	QTY./ CTN.	LBS./ CTN.	PRICE PER BIN	
				1 CTN.	3+ CTNS.
S-22364	4 x 18 x 4"	24	17	\$6.30	\$6.00
S-22365	7 x 18 x 4"	20	16	7.10	6.80
S-22366	4 x 24 x 4"	12	10	8.80	8.40
S-22367	7 x 24 x 4"	10	11	10.90	10.50

# SOLDER WIRE New



Flux Core Leaves No Residue

Assemble and repair circuit boards, wiring and small electrical motors.

- Melt with soldering iron to form permanent bonds.

**Leaded** – Low melting point for sensitive items. Easy to work with.

**Lead-Free** – Nontoxic, RoHS compliant for export products.



Solder Station, see [uline.com](http://uline.com)

## LEADED

MODEL NO.	COMPOSITION %	MELTING TEMP.	DIAM.	PRICE PER SPOOL		
				1	3	5+
S-25294	60/40 Tin/Lead	362°F	0.032"	\$60	\$55	\$50
S-25295	63/37 Tin/Lead					

## LEAD-FREE

MODEL NO.	COMPOSITION %	MELTING TEMP.	DIAM.	PRICE PER SPOOL		
				1	3	5+
S-25296	99.3/0.7 Tin/Copper	440°F	0.032"	\$80	\$75	\$70
S-25297	96.5/3/0.5 Tin/Silver/Copper	422°F		115	105	95

# ESD SAFE TWEEZER SET New



Handle tiny, sensitive components in electronics repair and assembly.

- Strong, anti-magnetic stainless steel with ESD-safe coating.
- Slim tips bend, separate or remove pieces.



MODEL NO.	DESCRIPTION	COMPONENTS	PRICE PER SET (MIN. 3)	
			3	8+
S-25214	3 Piece Tweezer Set	4½" Bent Tip 4½" Straight Tip 5½" Straight Tip	\$20	\$17

# ESD RESTOCKING CART New

Safely move static-sensitive parts to stock up workstations.

- 5" conductive casters and drag chain keep cart grounded.
- ESD-safe divider boxes slide in and out for easy access.



Optional Dividers, see page 751

MODEL NO.	CART DIM. L x W x H	BIN SIZE L x W x H	BINS/ CART	WT. (LBS.)	PRICE EACH	
					1	3+
H-10768	24 x 21 x 40"	20 x 15 x 6"	4	60	\$550	\$525

SHIPS UNASSEMBLED VIA UPS



# ESD SAFE DIVIDER BOXES

Customizable plastic storage for electronic parts and circuit boards.

- Strong carbon-infused walls protect contents from static damage. Stackable.
- Fully customizable for maximum flexibility.
- Lids – Snap on to protect contents from debris.

Dividers – Make compartments as small as 1¼" square. Sold separately.



## SOLD IN CARTON QUANTITIES

MODEL NO.	INSIDE DIM. L x W x H	BINS/CTN.	LBS./CTN.	PRICE EACH		SHORT DIVIDERS			LONG DIVIDERS			LIDS	
				1	3+	QTY./CTN.*	PRICE EACH		QTY./CTN.*	PRICE EACH		PRICE EACH	
							1	3+		1	3+	1	8+
S-25310	9 x 6 x 3½"	16	11	\$13	\$12	7	\$2.00	\$1.75	5	\$2.50	\$2.00	\$8	\$6
S-25311	9 x 6 x 5"	16	14	14	13	7	3.00	2.50	5	2.75	2.25	8	6
S-24188	15 x 9 x 3½"	8	10	16	15	11	2.25	2.00	7	3.50	3.20	12	10
S-21922	15 x 9 x 6"	8	13	19	18	11	3.50	3.20	7	4.10	3.80	12	10
S-25312	15 x 9 x 7"	6	11	21	20	11	4.00	3.70	7	5.00	4.50	12	10
S-21923	15 x 9 x 8"	6	12	23	22	11	3.90	3.50	7	5.00	4.60	12	10
S-25313	20 x 15 x 5"	4	11	35	33	15	4.50	4.00	11	5.50	5.00	18	16
S-22539	20 x 15 x 6"	4	12	37	35	15	4.40	4.00	11	5.20	4.80	18	16
S-21924	20 x 15 x 8"	4	16	45	43	15	4.90	4.50	11	6.00	5.40	18	16
S-22540	20 x 15 x 12"	3	18	63	60	15	9.50	8.80	11	10.50	9.80	18	16

\*Maximum number of dividers used per box

# CONDUCTIVE PCB RACKS New

Clean, dry and store sensitive circuit boards during manufacturing and repairs.

- Durable, carbon-infused plastic resists acids and temperatures up to 185°F.

MODEL NO.	OVERALL DIM. W x L	NO. OF SLOTS	LBS./CTN.	QTY./CTN.	PRICE PER RACK	
					10	20+
					S-25321	6 x 18"
S-25322	7 x 20"	20	20		50	49

MEETS MIL SPEC. MIL-B-81075-B

- Easy-to-load angled slots handle boards of any size.
- Open carrying handles and drainage holes.

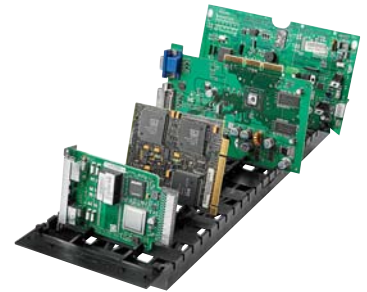

# CONDUCTIVE KITTING TRAYS New

Organize your assembly station. Protect small parts and components from static damage.

- Durable, carbon-infused plastic dissipates static and resists moisture.
- Individual compartments for microchips and LEDs.
- Stackable and nestable.



MODEL NO.	OVERALL DIM. L x W x H	NO. OF CELLS	CELL DIM. L x W	LBS./CTN.	QTY./CTN.	PRICE PER TRAY	
						10	20+
						S-25315	10 x 8 x 1"
S-25316	10 x 9 x 1"	12	2 x 2"			30	28

# ESD TRAYS

Minimize handling of sensitive electronics during assembly and transport.

- Fiberglass reinforced. Will never lose ability to eliminate static.
- Resists solvents and chemicals.
- Withstands temps from -60° to 250°F.



MODEL NO.	OVERALL DIMENSIONS L x W x H	WT. (LBS.)	PRICE PER TRAY	
			1	10+
S-19537	18 x 12 x 1"	1	\$24	\$22
S-19538	18 x 14 x 1"	1	27	25
S-19539	26 x 18 x 1"	3	30	28

# ANTI-STATIC TABLE MATS

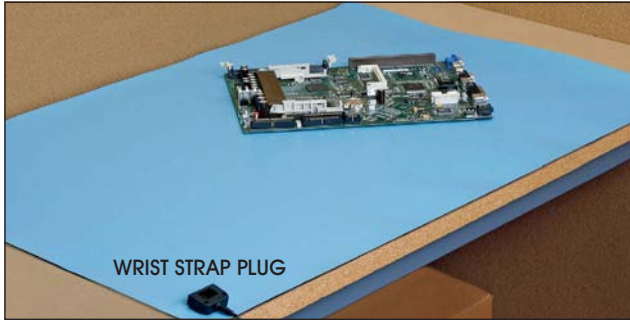

Protect your electronic devices. Transfer static charges from work surface to ground.

- Mats include two snap fasteners and grounding cord for wrist straps\*.

Vinyl – 3-layer construction. General packaging and assembly use.  
 Rubber – Heavy duty. For soldering, repair and chemical usage.

MEETS ESD STANDARD 4.1, ESD STANDARD 20.20, EIA625 AND MIL-STD-1686

MODEL NO.	DESCRIPTION	SIZE	THICKNESS	RESISTIVITY	PRICE EACH		
					1	3+	
S-12743	3 Layer Vinyl	2 x 3'	1/8"	10 <sup>7</sup> Ohms	\$80	\$75	
S-12744		2 x 4'			95	90	
S-14117		2 x 50'			650	625	
S-21920		3 x 50'			940	915	
S-12741	2 Layer Rubber	2 x 3'	1/16"	10 <sup>6</sup> Ohms	100	95	
S-12742		2 x 4'			115	110	
S-14118		2 x 50'			815	790	
S-21921		3 x 50'			1,000	975	
S-12745	15' Replacement Grounding Cord – \$17 each						

\*Wrist Strap Grounder sold below



STANDARD

## PERSONAL GROUNDERS

Stop static buildup at your workstation.

**Cup-Style Heel Grounders** – Elastic Velcro® strap for secure fit.

- Hi-Vis** – Elastic strap easily seen for compliance checks.

**Wrist Straps** – Soft fabric band for long-term use. Includes 6' cord.

- Deluxe** – Ultra soft and flexible for superior comfort.



HI-VIS



ECONOMY



DELUXE – ULTRA SOFT

MEETS ESD STANDARD 1.1/SP9.2, EIA625, MIL-STD-1686 AND MIL-HDBK-263

MODEL NO.	DESCRIPTION	STYLE	PRICE EACH	
			2	10+
H-936 H-6573	Cup-Style Heel Grounder	Standard	\$10	\$9
		Hi-Vis		
H-6574 H-935	6' Fabric Wrist Strap	Economy	N/A	7
		Deluxe	18	16

## ESD NYLON GLOVES

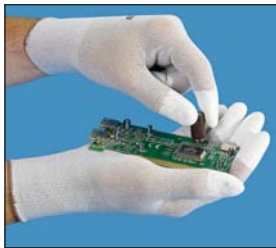

Protect sensitive electronics during assembly and inspection.

- Seamless nylon and conductive carbon knit.
- Protection up to 10<sup>8</sup> ohms.
- Reusable. Machine washable.

MODEL NO.	DESCRIPTION	SIZE	QTY./PACK	PRICE PER PACK	
				1	3+
S-15356	Uncoated	S, M, L, XL	12 Pair	\$33	\$31
S-15357	Fingertip Coated			40	36
S-15358	Palm Coated			42	39

## ESD CUT RESISTANT GLOVES

New

Extra protection while handling sharp circuit boards.

- Ultra-light Dyneema® Diamond and conductive carbon knit.
- Protection up to 10<sup>7</sup> ohms.
- Reusable. Machine washable.

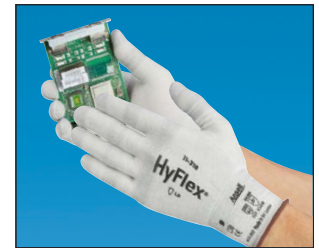

MODEL NO.	DESCRIPTION	ANSI CUT LEVEL	SIZE	PRICE/PAIR (MIN. 3)	
				3	12+
S-25233	HyFlex® 11-318	A2	S, M, L, XL	\$15	\$14



## ESD LAB JACKET

Protects against static transfer in laboratories and manufacturing.

- Comfortable carbon-suffused polyester.
- Chest pocket, 2 side pockets, snap front and wrists.
- Protection up to 10<sup>9</sup> ohms even after 50 washings.

MODEL NO.	DESCRIPTION	SIZE	COLOR	PRICE EACH	
				1	5+
S-20207	ESD Jacket	S, M, L, XL, 2XL	Blue	\$53	\$50

MEETS ANSI/ESD S20.20 AND STM2.1-2013

# LED MAGNIFIERS



SINGLE LENS

Bright, long-lasting white light.

- Use for precision assembly and parts repair.
- 36½" adjustable arm with table clamp and glass lens.
- 18-watt LED light. 50,000 hour life.
- Attached dust cover keeps lens clean.

Includes one lens: Standard 175%.

Swap in the lens you need.

- Use for circuit board assembly or joint inspection.
- 34" adjustable arm with table clamp and two glass lenses.
- 12-watt LED light. 50,000 hour life.
- Attached dust cover keeps lenses clean.

Includes two lenses: Standard 175% and your choice of 225% or 300%.

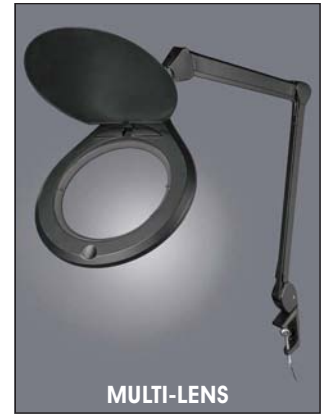

MULTI-LENS

UL/C-UL Listed

MODEL NO.	DESCRIPTION	SIZE L x W x H	ARM SIZE	MAGNIFICATION	PRICE EACH
H-6546	7 x 5" Magnifier	15 x 10 x 36"	36"	175%	\$229

MODEL NO.	DESCRIPTION	SIZE L x W x H	ARM SIZE	MAGNIFICATION	PRICE EACH
H-8788 H-8789	6" Magnifier	12 x 9 x 34"	34"	175% and 225% 175% and 300%	\$190 195



FABRIC

## ESD WORK STOOLS

Static control seating won't shock you.

- Brass drag chain acts as ground.
- Adjustable seat, backrest and footring.

Fabric – High density foam cushioning. Protection up to 10<sup>9</sup> ohms.

Polyurethane – Cleanroom Class 10 rated. Protection up to 10<sup>8</sup> ohms.



ESD GLIDES

EASY ASSEMBLY. SHIPS VIA UPS.

MODEL NO.	DESCRIPTION	SEAT DIM. W x D	CAP. (LBS.)	ADJUSTABLE HEIGHT	WT. (LBS.)	PRICE EACH	
						1	3+
H-3972	Fabric	18 x 17"	300	22-32"	30	\$435	\$420
H-3971	Polyurethane			20-30"	33	465	450
H-3973	Set of 5 ESD Casters – Optional				4	80	75



POLYURETHANE

## ESD TOP PACKING TABLES



Safe work surface for static-sensitive products.

- 1⅝" thick ESD top with rounded edges. Holds up to 500 lbs.
- Adjustable steel legs: 28 to 35" in 1½" increments.

Optional top shelf, drawers and table casters available, see page 518.

SHIPS UNASSEMBLED VIA MOTOR FREIGHT

MODEL NO.	DIMENSIONS L x W	ADJUSTABLE HEIGHT	WT. (LBS.)	PRICE EACH	
				1	2+
H-1135	60 x 30"	28-35"	146	\$535	\$510
H-1137	72 x 30"		160	585	555
H-1138	72 x 36"		194	640	615
H-1222	96 x 36"		258	865	840

## ANTI-STATIC WORKBENCH

Protect components from ESD damage during assembly and inspection.

- Adjustable anti-static laminate top protects from static electricity.
- Range of protection: 10<sup>6</sup> to 10<sup>9</sup> ohms.
- Grounding system provides two convenient wrist strap plugs.



Includes: Overhead fluorescent light fixture, bin rail, laminate shelf, locking drawer, ground kit and 12 electrical outlets.

EASY ASSEMBLY. SHIPS VIA MOTOR FREIGHT.

MODEL NO.	DIMENSIONS L x W	ADJUSTABLE HEIGHT	NO. OF DRAWERS	WT. (LBS.)	PRICE EACH
H-2043	60 x 30"	30-36"	1	235	\$1,999



# CLEANROOM WIPES



CLASS 100



PRESATURATED



CLASS 1000

Clean delicate equipment and wipe up spills in labs and cleanrooms.

**Class 100** – Soft 100% polyester. Nonabrasive and absorbent. Extremely low lint. For ISO class 5 or higher.

**Berkshire** – 100% knit polyester with knife-cut edge. Gently cleans your most critical equipment. For ISO class 5 or higher.

**Presaturated** – Polyester wipes saturated with 70% isopropyl alcohol and 30% deionized water. For ISO class 5 or higher.

**Class 1000** – Non-woven cellulose/polyester blend. Strong and highly absorbent. For ISO class 6 or higher.

MODEL NO.	DESCRIPTION	SHEET SIZE	SHEETS/PACK	PRICE PER PACK		
				1	5	10+
S-18512	Class 100	9 x 9"	150	\$40	\$39	\$38
S-21942*	Berkshire Class 100			94	92	90

MODEL NO.	DESCRIPTION	SHEET SIZE	SHEETS/PACK	PRICE PER PACK		
				1	5	10+
S-20209	Presaturated Class 100	9 x 9"	30	\$25	\$24	\$23
S-21888	Class 1000			26	25	24

\* Pictured on uLINE.com

## MICROFIBER CLEANROOM WIPES



CLASS 10

Polish screens and lenses without scratching.

- 4x the filaments of ordinary microfiber wipes.
- Ultra-soft knit polyester/nylon blend with sealed edge.
- For ISO class 4 or higher.

MODEL NO.	DESCRIPTION	SHEET SIZE	SHEETS/PACK	PRICE PER PACK		
				1	5	10+
S-24158	Microfiber Class 10	9 x 9"	100	\$70	\$68	\$65

## CLEANROOM SWABS

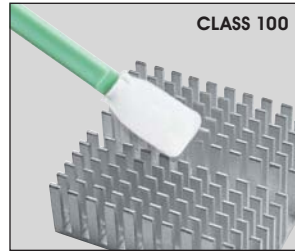

CLASS 100

Recommended for precision cleaning in small spaces.

- Rigid polypropylene handles provide control.
- Lint-free, polyurethane foam tips. Nonabrasive.

MODEL NO.	TIP SHAPE	HEAD LENGTH	OVERALL LENGTH	QTY./BAG	PRICE PER BAG	
					1	5+
S-25211	Round	.5"	3"	500	\$65	\$60
S-25212	Pointed	.5"	3"	500	75	70
S-25213	Rectangular	1"	5"	100	40	35

## ULINE CLEANROOM MOP



CLASS 100

Disinfect cleanroom floors.

- Low profile swivel head fits under equipment.
- Stainless steel and aluminum construction.

**Wipers** – Highly absorbent, polyester material. Low lint.

Starter Kit includes: Mop head, telescopic handle and ten wipers.

MODEL NO.	DESCRIPTION	SIZE	QTY./PACK	PRICE EACH	
				1	5+
H-7250	Starter Kit	4 x 24"	1	\$145	\$140
S-22472	Replacement Wipers	8 x 25"	10	\$22/pk.	10+/\$18 pk.

## CLEANROOM STICKY ROLLER



Trap small particles and prevent contamination.

- Chubby, tacky roll conforms to uneven walls and tables.
- Adhesive film perforated every 16".

Starter Kit includes: 18" roll and 12" long stainless steel handle with plastic grip.

MODEL NO.	DESCRIPTION	PRICE EACH	
		1	5+
H-7251	Starter Kit	\$209	\$199
H-7252	Adjustable 3-6' Handle Extension	38	35

MODEL NO.	DESCRIPTION	SHEETS/ROLL	ROLLS/PK.	PRICE PER PACK
S-22473	18" Roller Refills	20	4	1/\$199 5+/\$189

# CLEAN MATS

SPECIFY COLOR: ■ Blue ■ White ■ Gray

MODEL NO.	SIZE	SHEETS/CTN.	DESCRIPTION	PRICE PER CARTON			
				1	5	10+	
H-1566	18 x 36"	60	Clean Mat Sheets w/ Frame	\$69	\$67	\$65	
H-3463	18 x 45"	60		84	80	77	
H-933	24 x 30"	60		75	72	69	
H-1567	24 x 36"	60		90	86	83	
H-3464	24 x 45"	60		108	103	99	
H-2036	36 x 36"	60		119	114	109	
H-1238	36 x 45"	60		134	128	122	
■H-1568	36 x 60"	30		189	181	174	
H-1569	18 x 36"	60		Replacement Pads	49	47	45
H-3465	18 x 45"	60			60	58	56
H-934	24 x 30"	60	59		57	55	
H-1570	24 x 36"	60	62		59	57	
H-3466	24 x 45"	60	74		71	68	
H-2037	36 x 36"	60	79		76	73	
H-1239	36 x 45"	60	89		85	82	
■H-1571	36 x 60"	30	96		92	89	



Stop dirt contamination in your workplace.

- Recommended uses: White – Microelectronics and aerospace; Blue – Pharmaceutical use; Gray – Renovation projects.
- Use each sheet many times before peeling off.

■ SHIPS VIA MOTOR FREIGHT

## ANTI-STATIC MATS



Eliminate electrical shock damage.

- Foam vinyl mat reduces muscle strain.
- 10' grounding cord included.

Meets Mil-HDBK & Mil-STD-1686. RTG=10<sup>9-10</sup> Ohms. EOS/ESD 7.1-1991.

MODEL NO.	SIZE	THICKNESS	PRICE EACH		
			1	3	6+
H-894	2 x 3'	3/8"	\$50	\$48	\$46
H-896	3 x 4'		91	88	85
H-895	3 x 5'		96	92	88
H-897	3 x 10'		199	193	187
H-4563	3 x 12'		239	232	224
H-1300	4 x 6'		160	155	149
H-898	10' Replacement Grounding Cord – \$19 each				

**ROLLS** Includes 6 grounding cords, one every 10 feet

H-1301	3 x 60'	3/8"	\$755	\$725	\$695
H-2038	4 x 60'		1,065	1,030	995

SHIPS VIA MOTOR FREIGHT

## ANTI-FATIGUE CONDUCTIVE MATS



Dual-purpose mat.

**Anti-Fatigue** – Cushy nitricell sponge with slip-resistant diamond plate surface.

**Anti-Static** – Dissipates surface static up to 10<sup>6</sup> ohms.

- Recommended for areas with cash registers, computers and electronic equipment.
- 15' grounding cord included.

MODEL NO.	SIZE	THICKNESS	PRICE EACH		
			1	3	6+
H-2039	2 x 3'	9/16"	\$117	\$113	\$107
H-2040	3 x 4'		212	205	193
H-2041	3 x 5'		247	239	225
H-2042	15' Replacement Grounding Cord – \$19 each				

## CLEAN STRIDE MATS

Combine the dirt-scraping power of a Waterhog™ mat with the dust pickup of a clean mat.

MODEL NO.	SIZE	SHEETS/MAT	DESCRIPTION	PRICE EACH	
				1	5+
H-3467	26 x 63"	60	Waterhog™ Mat w/ Clean Mat Pad	\$125	\$115
H-3468	36 x 92"		215	195	
H-934W	24 x 30"	60	Replacement Pads	59	57
H-3471	34 x 44"			99	89



# NITRILE CLEANROOM GLOVES

CLASS 100



S-13046



S-20204



S-21940

Prevent contamination in electronic and pharmaceutical environments.

- Powder-free, latex-free. Puncture resistant.
- 12" long with beaded cuff. Textured fingertips for secure grip.

**Non-Sterile** – Clean processed. For optics and electronics manufacturing.

**Sterile** – Bacteria-free. For medical and pharmaceutical applications.

## NITRILE GLOVES

MODEL NO.	DESCRIPTION	MIL	SIZE	GLOVES/BAG	PRICE/BAG (MIN. 2)	
					2	10+
S-13046	Non-Sterile	5	S, M, L, XL	100	\$33	\$32
S-20204	Sterile				105	100

## ANSSELL TOUCH N TUFF® NITRILE GLOVES

MODEL NO.	DESCRIPTION	MIL	SIZE	GLOVES/BAG	PRICE/BAG (MIN. 2)	
					2	10+
S-21940	Non-Sterile	5	S, M, L, XL	100	\$43	\$41
S-21941	Sterile				119	113



CLASS 100

# CLEANROOM LATEX GLOVES

Superior dexterity in cleanroom environments. • Silicone and powder-free.

- Textured fingertips. Excellent tactile sensitivity.
- 12" long. Beaded cuff.

MODEL NO.	DESCRIPTION	MIL	SIZE	GLOVES/BAG	PRICE/BAG (MIN. 2)	
					2	10+
S-18509	Powder-Free	5	S, M, L, XL	100	\$33	\$32

# CLEANROOM TAPE



TEMPERATURE RANGE  
-20° TO 200°F

Seal bags and packages or mark floors and surfaces in biotech and medical labs.

- For Class 1 (ISO 3) cleanrooms.
- High-tack adhesive sticks firmly, removes cleanly.
- Polyethylene backing with rubber adhesive.

SPECIFY COLOR: Clear, Blue or White

MODEL NO.	SIZE W x L	MIL	ROLLS/CASE	PRICE PER ROLL (MIN. 6)		
				6	24	48+
S-20217	1" x 36 yds.	7	48	\$19	\$18	\$17
S-20218	2" x 36 yds.		24	33	31	29

# CLEANROOM POLY TUBING

Cut to size to create custom fit cleanroom bags.

- Package sensitive electronics and medical devices.
- Plastic core prevents contamination.
- Class 100 (ISO Class 5) rated.



MODEL NO.	ROLL SIZE	MIL	LBS./ROLL	PRICE PER ROLL		
				1	3	6+
S-19541	8" x 500'	4	14	\$160	\$150	\$140
S-19542	12" x 500'		22	210	195	185
S-19543	24" x 500'		43	340	320	300



CLASS 10

# CLEANROOM LABELS New

THERMAL TRANSFER

Label beakers, bags and samples with no risk of contamination.

- Matte polypropylene labels with acrylic adhesive. Plastic core won't shed particles.
- Works with Zebra, Sato and other desktop thermal transfer printers.
- Cleaned, double-bagged for ISO Class 4 and higher.

SOLD IN CASE QUANTITIES

MODEL NO.	SIZE W x H	LABELS/ROLL	ROLLS/CASE	PRICE PER ROLL (MIN. 4)	
				4	8+
S-25228	3 x 1"	1,000	4	\$130	\$120
S-25229	4 x 2"			170	160

Ribbons required



# CLEANROOM PROTECTIVE CLOTHING

Comfortable and contaminant-free! Extremely low lint for cleanroom environments.

- Recommended for pharmaceutical, aerospace and semiconductor manufacturers.
- Breathable, SMS polypropylene fabric protects against light liquid splash. Bound seams.
- Cleaned and bagged for class 100 (ISO class 5) or higher cleanrooms.

**Coverall** – Zip front, round neck, elastic wrists and ankles.  
**Hood** – Shoulder length pullover. Elastic, full-face opening.  
**Bouffant** – Provides full hair coverage. Elastic fit.  
**Lab Coat** – Snap front, fold-down collar and elastic wrists.  
**Boot Cover** – Ankle ties and gripper soles.



MODEL NO.	DESCRIPTION	SIZE	QTY./CTN.	PRICE PER CARTON	
				1	3+
S-25203	Elastic Coverall	M, L, XL, 2XL	25	\$375	\$350
S-25202	Hood	One Size Fits All	100	390	370
S-22470	Bouffant		250	350	330
S-25215	Lab Coat	M, L, XL	25	190	180
S-25210	Boot Cover		50 pr.	425	400



## GOWNING BENCHES *New*

Suit up without a snag. Smooth, rolled edges won't tear your expensive coveralls.

- Type 304 stainless steel resists rust and corrosion. Easy to wash down.
- For class 1000 (ISO class 6) or higher cleanrooms.
- Bolt to floor for stability.

MODEL NO.	DESC.	SIZE L x W x H	CAP. (LBS.)	WT. (LBS.)	PRICE EACH	
					1	2+
H-10751	Bench	36 x 12 x 18"	750	26	\$1,300	\$1,200
H-10752		48 x 12 x 18"			1,500	1,400

SHIPS UNASSEMBLED VIA UPS

## LOCK AND PRESS ENVELOPES

Reclosable bags with adhesive back.

- Open and close without ruining envelope.

MODEL NO.	INSIDE DIMENSIONS	MIL	QTY./CTN.	PRICE PER CARTON			LBS./CTN.
				1	2	5+	
S-128	4 x 6"	2	1,000	\$96	\$91	\$85	11
S-3826	5 x 10"		1,000	182	164	158	19
S-129	6 x 6"		1,000	134	125	117	15
S-130	6 x 9"		1,000	163	157	146	20
S-1479	8 x 10"	2	500	112	103	96	15
S-131	9 x 12"		500	147	140	131	20
S-11190	10 x 13"		250	105	99	94	12



Recommended for frequently checked documents.

## CLEAR PACKING LIST ENVELOPES

Shipping address, documents and instructions shine through with these transparent front and back envelopes.

MODEL NO.	OUTSIDE DIMENSIONS	MIL	QTY./CTN.	PRICE PER CARTON			LBS./CTN.
				1	3	5+	
S-11188	4½ x 5½"	2	1,000	\$32	\$31	\$29	7
S-11189	5½ x 7½"		1,000	61	58	55	10
S-15359	6½ x 10"		1,000	105	102	97	16
S-12997	9½ x 12"		500	89	83	78	14



Pressure-sensitive backing sticks to wood, metal and plastic.

# PACKING LIST ENVELOPES

- Pressure-sensitive backing attaches securely to almost anything – paper, wood, plastic or metal.
- Outside dimensions listed.
- Side loading unless otherwise shown.
- Tamperproof 2 mil poly protects documents inside.

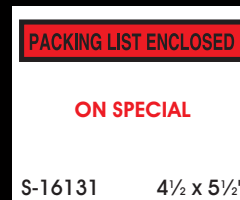

Thicker 2.5 mil poly for extra protection.

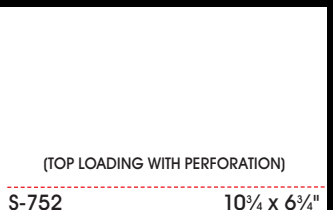
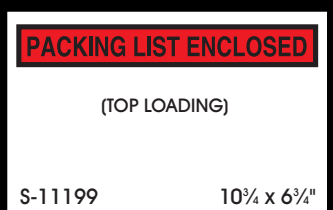
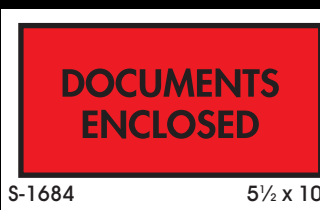
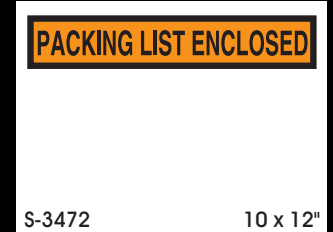
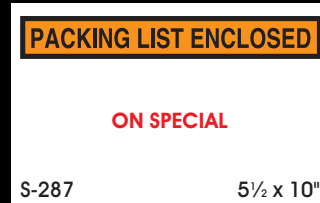

MODEL NO.	OUTSIDE DIMENSIONS	QTY./CTN.	PRICE PER CARTON				LBS./CTN.
			1	3	5	10+	
S-206	4 1/2 x 5 1/2"	1,000	\$43	\$42	\$40	\$34	9
S-207	4 1/2 x 5 1/2"	1,000	\$29 per carton any quantity				9
S-286	7 1/2 x 5 1/2"	1,000	\$55 per carton any quantity				15
S-287	5 1/2 x 10"	1,000	\$75 per carton any quantity				20
S-560	7 x 5 1/2"	1,000	73	70	67	59	15
S-619	4 1/2 x 6"	1,000	\$34 per carton any quantity				10
S-752	10 3/4 x 6 3/4"	1,000	117	113	109	101	21
S-1684	5 1/2 x 10"	1,000	95	89	84	77	20
S-2109	7 x 6"	1,000	77	74	71	65	16

MODEL NO.	OUTSIDE DIMENSIONS	QTY./CTN.	PRICE PER CARTON				LBS./CTN.
			1	3	5	10+	
S-2326	4 1/2 x 6"	1,000	\$44	\$43	\$41	\$35	10
S-2589	7 1/2 x 5 1/2"	1,000	72	69	66	58	15
S-2985	4 1/2 x 5 1/2"	1,000	43	42	40	34	9
S-3472	10 x 12"	500	128	124	119	109	20
S-3584	5 1/2 x 10"	1,000	95	89	84	77	20
S-5017	5 1/2 x 10"	1,000	95	89	84	77	20
S-5966	10 x 12"	500	128	124	119	109	20
S-11199	10 3/4 x 6 3/4"	1,000	117	113	109	101	23
S-16131	4 1/2 x 5 1/2"	1,000	\$25 per carton any quantity				9

# PACKING LIST ENVELOPES

## SUPER STICK®

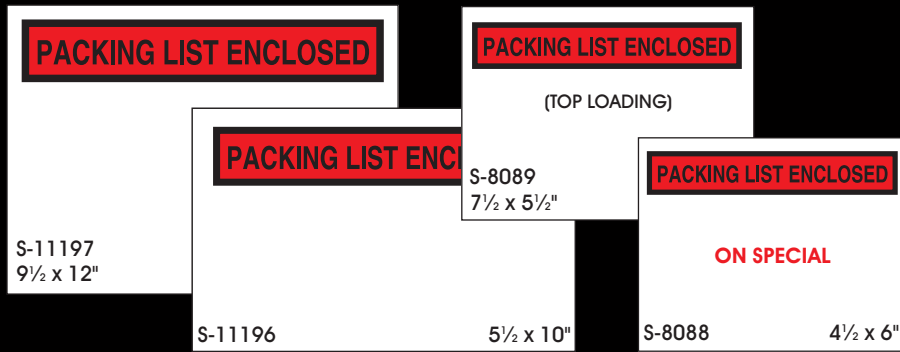

## AMERICAN FLAG



Uline Exclusive – Super strong adhesive recommended for boxes with high recycled content.

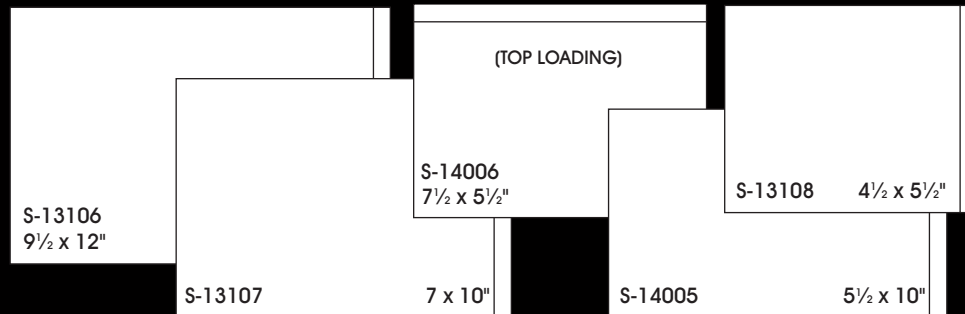

MODEL NO.	OUTSIDE DIMENSIONS	QTY./ CTN.	PRICE PER CARTON				LBS./ CTN.
			1	3	5	10+	
S-7815	4 1/2 x 5 1/2"	1,000	\$27 per carton any quantity				9
S-8085	7 1/2 x 5 1/2"	1,000	\$73	\$70	\$67	\$59	15
S-8088	4 1/2 x 6"	1,000	\$36 per carton any quantity				10
S-8089	7 1/2 x 5 1/2"	1,000	73	70	67	59	15
S-11196	5 1/2 x 10"	1,000	96	90	85	78	20
S-11197	9 1/2 x 12"	500	114	109	105	98	17

MODEL NO.	OUTSIDE DIMENSIONS	QTY./ CTN.	PRICE PER CARTON				LBS./ CTN.
			1	3	5	10+	
S-11198	5 1/2 x 10"	1,000	\$96	\$90	\$85	\$78	20
S-13106	9 1/2 x 12"	500	114	109	105	98	17
S-13107	7 x 10"	1,000	122	114	110	104	21
S-13108	4 1/2 x 5 1/2"	1,000	44	43	41	35	8
S-14005	5 1/2 x 10"	1,000	96	90	85	78	16
S-14006	7 1/2 x 5 1/2"	1,000	73	70	67	59	12

## SPECIAL USE

More Special Use Packing List Envelopes, page 762.



MODEL NO.	OUTSIDE DIMENSIONS	QTY./ CTN.	PRICE PER CARTON				LBS./ CTN.
			1	3	5	10+	
S-15064	5 1/2 x 7 1/2"	1,000	\$72	\$69	\$66	\$58	15
S-15065	7 1/2 x 5 1/2"	1,000	\$72	\$69	\$66	\$58	15

## ENVIRONMENTALLY FRIENDLY

Quick strong hold. Hot melt adhesive backing.

- 100% recycled polyethylene.
- Kraft paper backing.
- Side loading.



MODEL NO.	OUTSIDE DIMENSIONS	QTY./ CTN.	PRICE PER CARTON				LBS./ CTN.
			1	3	5	10+	
S-15066	4 1/2 x 5 1/2"	1,000	\$52	\$51	\$49	\$43	9



# PACKING LIST ENVELOPES

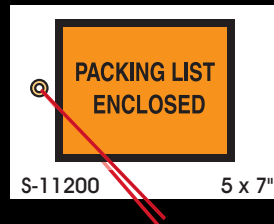
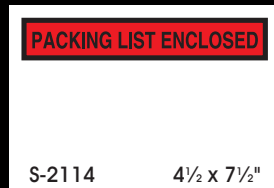
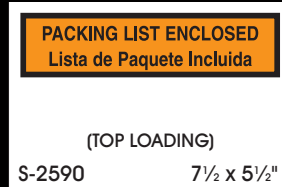
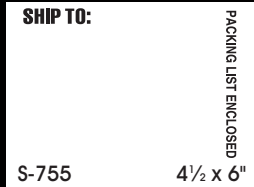
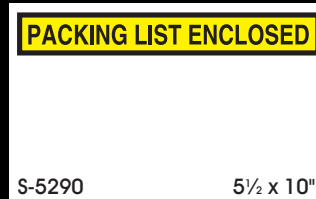
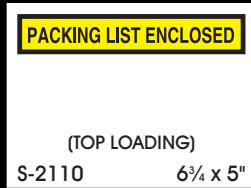
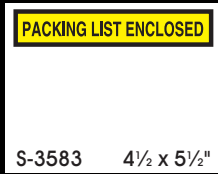

## HANGING STYLE

Hangs on machinery or odd-size products.

- Reclosable, reusable.
- Clear, non-adhesive.

# INVOICE ENCLOSED ENVELOPES

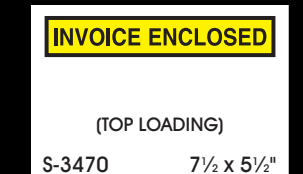
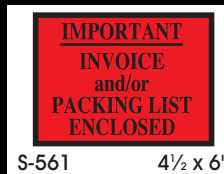
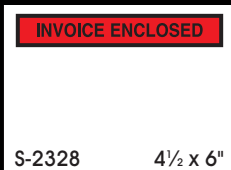
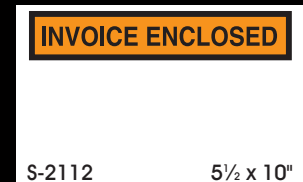
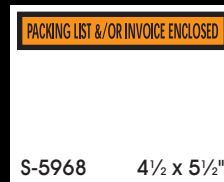
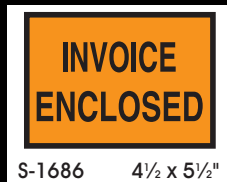
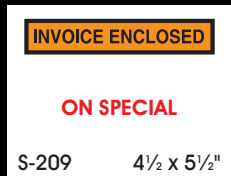

MODEL NO.	OUTSIDE DIMENSIONS	QTY./ CTN.	PRICE PER CARTON				LBS./ CTN.
			1	3	5	10+	
S-209	4 1/2 x 5 1/2"	1,000	\$27 per carton any quantity				9
S-561	4 1/2 x 6"	1,000	\$44	\$43	\$41	\$35	10
S-755	4 1/2 x 6"	1,000	44	43	41	35	10
S-1686	4 1/2 x 5 1/2"	1,000	43	42	40	34	9
S-1687	4 1/2 x 6"	1,000	44	43	41	35	10
S-2110	6 3/4 x 5"	1,000	77	74	71	63	13
S-2112	5 1/2 x 10"	1,000	95	89	84	77	20
S-2114	4 1/2 x 7 1/2"	1,000	66	62	59	53	12
S-2327	4 1/2 x 6"	1,000	44	43	41	35	10

MODEL NO.	OUTSIDE DIMENSIONS	QTY./ CTN.	PRICE PER CARTON				LBS./ CTN.
			1	3	5	10+	
S-2328	4 1/2 x 6"	1,000	\$44	\$43	\$41	\$35	10
S-2590	7 1/2 x 5 1/2"	1,000	72	69	66	58	15
S-3470	7 1/2 x 5 1/2"	1,000	72	69	66	58	15
S-3583	4 1/2 x 5 1/2"	1,000	43	42	40	34	9
S-5289	10 x 12"	500	128	124	119	109	20
S-5290	5 1/2 x 10"	1,000	95	89	84	77	20
S-5968	4 1/2 x 5 1/2"	1,000	43	42	40	34	9
S-6219	4 1/2 x 6"	1,000	\$34 per carton any quantity				10
S-11200	5 x 7"	1,000	196	187	179	162	15
S-12945	4 1/2 x 5 1/2"	1,000	43	42	40	34	9

# PACKING LIST ENVELOPES

- Pressure-sensitive backing attaches securely to almost anything – paper, wood, plastic or metal.
- Tamperproof 2 mil poly protects documents inside.
- Outside dimensions listed. • All envelopes on this page have CLEAR outer face.

**\$75 PER CARTON  
ANY QUANTITY  
ON SPECIAL**

S-751

5½ x 10"

## SIDE LOADING

S-5940 3 x 4½"	S-2978 3½ x 5"	<b>ON SPECIAL</b> S-205 4½ x 5½"	S-298 4½ x 6"	S-2979 4½ x 7½"
S-2591 5½ x 8"	S-3473 6 x 9"	S-1689 6½ x 10"	S-2723 6 x 12"	
S-754 7 x 10"	<b>ON SPECIAL</b> S-753 9½ x 12"	S-5942 9 x 14"		

## TOP LOADING

 S-2593 4 x 3"	S-6222 5½ x 4½"	S-5291 6½ x 5½"	S-2980 7 x 6"
<b>ON SPECIAL</b> S-750 7½ x 5½"	S-5941 9½ x 6"	S-2592 10¼ x 7"	S-2982 12 x 15"

MODEL NO.	OUTSIDE DIMENSIONS	QTY./ CTN.	PRICE PER CARTON				LBS./ CTN.	MODEL NO.	OUTSIDE DIMENSIONS	QTY./ CTN.	PRICE PER CARTON				LBS./ CTN.
			1	3	5	10+					1	3	5	10+	
S-205	4½ x 5½"	1,000	<b>\$27 per carton any quantity</b>				8	S-2978	3½ x 5"	1,000	\$52	\$49	\$47	\$41	6
S-298	4½ x 6"	1,000	\$44	\$43	\$41	\$35	8	S-2979	4½ x 7½"	1,000	66	62	59	53	10
S-750	7½ x 5½"	1,000	<b>\$55 per carton any quantity</b>				12	S-2980	7 x 6"	1,000	77	74	71	65	12
S-751	5½ x 10"	1,000	<b>\$75 per carton any quantity</b>				16	S-2982	12 x 15"	500	182	176	168	151	27
S-753	9½ x 12"	500	<b>\$69 per carton any quantity</b>				16	S-3473	6 x 9"	1,000	108	102	97	92	19
S-754	7 x 10"	1,000	119	113	109	102	20	S-5291	6½ x 5½"	1,000	74	71	68	61	10
S-1689	6½ x 10"	1,000	115	110	105	98	16	S-5940	3 x 4½"	1,000	34	33	31	28	4
S-2591	5½ x 8"	1,000	80	76	73	68	11	S-5941	9½ x 6"	1,000	115	110	105	98	15
S-2592	10¼ x 7"	1,000	132	127	122	113	21	S-5942	9 x 14"	500	109	104	99	90	16
S-2593	4 x 3"	1,000	34	33	31	28	4	S-6222	5½ x 4½"	1,000	43	42	40	34	8
S-2723	6 x 12"	1,000	132	127	123	114	22								

# PACKING LIST ENVELOPES

## SPECIAL USE ENVELOPES

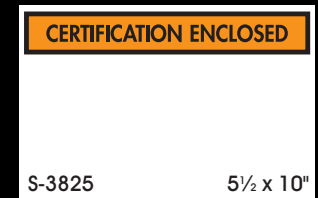
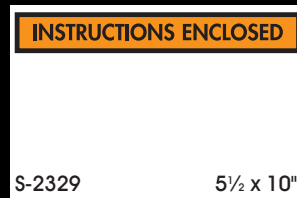
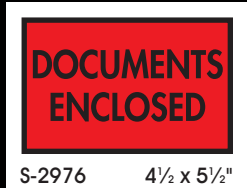
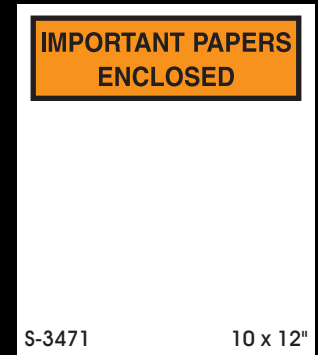
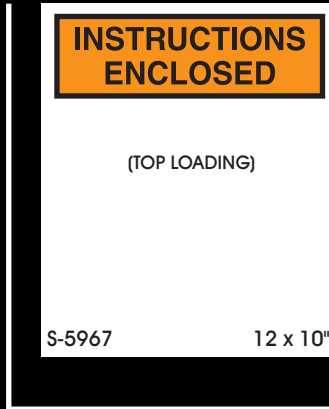
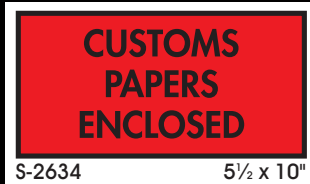
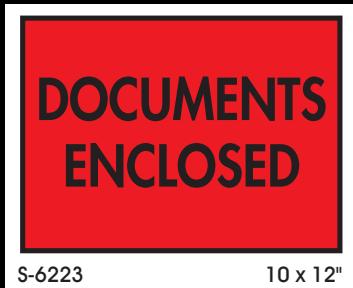

## TRANSPORTATION ENVELOPES

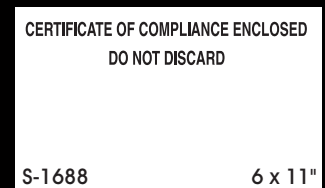
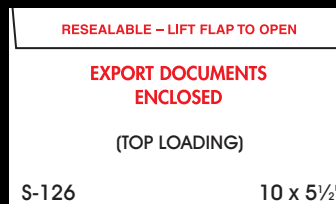
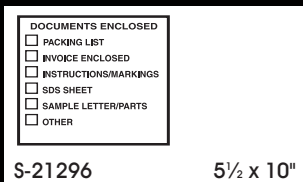

## SDS ENVELOPES

New SDS Packing List Envelopes replace previous MSDS product.

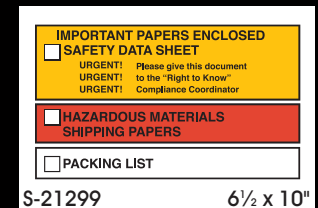
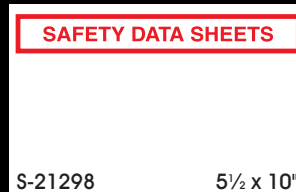

## MILITARY ENVELOPES

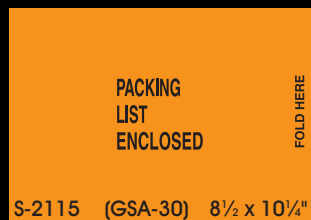

S-2115 and S-2116 meet Gov't Spec. A-A-1659A.

## OPEN END IBM STYLE



MODEL NO.	OUTSIDE DIMENSIONS	QTY./CTN.	PRICE PER CARTON				LBS./CTN.
			1	3	5	10+	
S-126	10 x 5 1/2"	1,000	\$132	\$127	\$124	\$114	20
S-210	4 x 8"	1,000	58	56	54	48	10
S-284	4 3/8 x 9"	1,000	67	63	60	56	12
S-1683	5 1/2 x 10"	1,000	95	89	84	77	20
S-1688	6 x 11"	1,000	130	125	121	112	22
S-2113	5 1/2 x 10"	1,000	95	89	84	77	20
S-2115	8 1/2 x 10 1/4"	1,000	225	215	206	191	30
S-2116	5 1/4 x 8"	1,000	111	106	101	94	15
S-2329	5 1/2 x 10"	1,000	95	89	84	77	20
S-2634	5 1/2 x 10"	1,000	95	89	84	77	20

MODEL NO.	OUTSIDE DIMENSIONS	QTY./CTN.	PRICE PER CARTON				LBS./CTN.
			1	3	5	10+	
S-2976	4 1/2 x 5 1/2"	1,000	\$43	\$42	\$40	\$34	9
S-3471	10 x 12"	500	128	124	119	109	20
S-3825	5 1/2 x 10"	1,000	95	89	84	77	20
S-5967	12 x 10"	500	128	124	119	109	20
S-6223	10 x 12"	500	128	124	119	109	20
S-8067	5 1/2 x 10"	1,000	95	89	84	77	20
S-21296	5 1/2 x 10"	1,000	95	89	84	77	20
S-21297	6 1/2 x 5"	1,000	75	72	69	61	12
S-21298	5 1/2 x 10"	1,000	95	89	84	77	20
S-21299	6 1/2 x 10"	1,000	115	110	106	98	17



# ULINE BUBBLE MASK®

STICKS TO PRODUCT

Adhesive bubble sticks to your product. Applies easily to odd-shaped surfaces.

- Eliminates clumsy application of tape. (Not usable on finished wood surfaces.)
- Clean – Leaves no residue. • Easy to remove. Reusable.
- Heavy-duty Bubble Wrap® Strong bubble protects corners from scratches.



## DISPENSER BOX

MEETS FED. SPEC. PPP-C-795D-Class 1

MODEL NO.	BUBBLE SIZE	ROLL SIZE	LBS./CTN.	PRICE PER CARTON				
				1	3	6	10	20+
S-5448*	3/16"	12" x 175'	7	\$49	\$47	\$45	\$43	\$41

## ROLLS

MODEL NO.	BUBBLE SIZE	ROLL SIZE	LBS./ROLL	PRICE PER ROLL			
				1	2	4	8+
S-3236 S-3236P*	3/16"	6" x 300'	4	\$38	\$37	\$36	\$32
S-814P*		12" x 300'	8	\$56 per roll any quantity			
S-815P* ■S-12617P*	3/16"	24" x 300'	15	116	111	107	103
		48" x 300'	30	230	222	213	204
S-10587P* ■S-10588P*	1/2"	12" x 125'	6	37	36	34	30
		24" x 125'	11	71	70	66	62

\* Perforated every 12"

■ SHIPS VIA MOTOR FREIGHT

# ULINE COLD SEAL® BUBBLE

MAKE YOUR OWN BAGS

Wraps tightly and neatly around odd-sized, large or small objects. Sticks to itself, not to the product.

- Leaves no residue on wrapped item. • Perforated every 12".
- Bubble Wrap® Strong bubble ideal for warehouses, mailrooms or retail stores.



S-2195P



MEETS FED. SPEC. PPP-C-795D-Class 1

ROLLS SOLD IN FULL BUNDLES

MODEL NO.	BUBBLE SIZE	ROLL SIZE	ROLLS/BUNDLE	PRICE PER ROLL			
				1-2	4	8	12+
S-818*	3/16"	12" x 175'	N/A	\$46 per box any quantity			
S-14582P	3/16"	6" x 300'	8	N/A	N/A	\$36	\$34
S-2194P		12" x 300'	4	N/A	\$67	63	61
S-2195P		24" x 300'	2	\$119	114	108	106
■S-13632P		48" x 300'	1	230	222	212	203

\* Dispenser Box

■ SHIPS VIA MOTOR FREIGHT

# BUBBLE CORNER GUARDS

Protect frames, mirrors and panels from corner damage during shipping.



- Heavy-duty 3rd web bubble for maximum protection.
- Perforated roll for easy dispensing.

MODEL NO.	SIZE	DIMENSIONS L x W	QTY./CTN.	PRICE PER CARTON		
				1	3	5+
S-12896	Small	5½ x 5½"	375	\$52	\$49	\$46
S-12897	Medium	8 x 8"	250	57	54	51
S-12898	Large	11 x 11"	188	66	63	60

# FOAM TUBING

MAKE YOUR OWN PACKAGING

Recommended for protecting and packing long and odd-shaped products.



- 1/8" thick foam protects steel tubing, glass and other scratch-sensitive items.
- Seal ends with Heat Sealers, pages 154-155.

MODEL NO.	INSIDE W x L	LBS./ROLL	PRICE PER ROLL		
			1	3	6+
S-19335	3" x 100'	1	\$60	\$56	\$52
S-11824	4" x 100'	1	66	62	58
S-11825	6" x 100'	2	71	67	63



### ULINE AIR

Save up to 50% with Uline's Air Bubble.

- Perforated every 12 inches.
- Recommended protection for products with **short ship cycles**.

### ULINE AIR PLUS

Guaranteed long-term protection for shipment or storage.

- Bubble Wrap® Strong – Nylon barrier to prevent air loss.
- Ideal for **heavier weight and fragile** shipments.

### ULINE AIR

MODEL NO.	BUBBLE SIZE	BUBBLE USE	ROLL SIZE	LBS./CTN.	PRICE PER CARTON				
					1	3	6	10	20+
S-1012	3/16"	Layering	12" x 175'	4	<b>\$20 per carton any quantity</b>				
S-1013			24" x 150'	7					
S-1014▲	5/16"	Semi-Rugged Products	12" x 120'	5	28	27	25	24	22
S-1015			24" x 90'	7	41	39	37	34	30
S-5120	1/2"	Dunnage, Void Fill	12" x 75'	5	24	23	22	20	19
S-5121			24" x 75'	7	40	37	35	32	29

Perforated every 12". ▲Two 60' rolls per carton.

### ULINE AIR PLUS – BUBBLE WRAP® STRONG

MEETS FED. SPEC. PPP-C-795D-Class 1

MODEL NO.	BUBBLE SIZE	BUBBLE USE	ROLL SIZE	LBS./CTN.	PRICE PER CARTON				
					1	3	6	10	20+
S-214	3/16"	Layering	12" x 175'	5	\$41	\$39	\$37	\$35	\$32
S-626			24" x 175'	10	80	75	70	66	62
S-215▲	5/16"	Void Fill, Large Heavy Items	12" x 170'	7	54	50	47	45	42
S-627			24" x 85'						

Perforated every 12". ▲Two 85' rolls per carton.



## ULINE UPSABLE ROLLS

### SINGLE ROLLS

#### INDUSTRIAL DUTY – For short ship cycles.

\* Perforated every 12 inches

MODEL NO.	BUBBLE SIZE	ROLL SIZE	LBS./ROLL	PRICE PER ROLL			
				1	3	6	10+
S-2501	3/16"	12" x 300'	4	\$37	\$35	\$32	\$29
S-2501P*		12" x 300'	4	<b>\$29 per roll any quantity</b>			
S-2502		24" x 300'	7	69	65	62	58
S-2502P*		24" x 300'	7	69	65	62	58
S-14584P*		48" x 190'	11	87	81	76	71
S-2503	5/16"	12" x 188'	4	29	27	26	24
S-2503P*		12" x 188'	4	29	27	26	24
S-2504		24" x 150'	4	42	40	38	35
S-2504P*		24" x 150'	4	42	40	38	35
S-3223	1/2"	12" x 125'	3	27	25	24	23
S-3223P*		12" x 125'	3	27	25	24	23
S-3224		24" x 100'	6	41	39	37	34
S-3224P*		24" x 100'	6	41	39	37	34

Single rolls are recommended for medium volume users.

- Industrial Duty bubble has a light nylon barrier. For lightweight and semi-rugged items.
- Bubble Wrap® Strong has a **heavy-duty nylon barrier**. Use for fragile, valuable items.

#### BUBBLE WRAP® STRONG – Heavy duty for longer ship cycles.

\* Perforated every 12 inches

MODEL NO.	BUBBLE SIZE	ROLL SIZE	LBS./ROLL	PRICE PER ROLL			
				1	3	6	10+
S-5995P*	3/16"	12" x 300'	5	\$48	\$46	\$44	\$41
S-5996P*		24" x 300'	8	97	92	87	82
S-6686P*	5/16"	12" x 188'	5	47	44	42	40
S-6687P*		24" x 150'	8	75	70	67	63
S-5997P*	1/2"	12" x 125'	4	44	42	39	37
S-5998P*		24" x 100'	7	69	66	62	59

# ULINE ECONOMY AIR BUBBLE

FOR LIGHT DUTY, SHORT SHIP CYCLES

PERFORATED ROLLS – Cross-perforated every 12" for easy tear-off. **SOLD IN FULL BUNDLES**

MODEL NO.	BUBBLE SIZE	BUBBLE USE	ROLL SIZE	LBS./BNDL.	ROLLS/BNDL.	PRICE PER ROLL			
						1 BNDL.	2 BNDLS.	3 BNDLS.	4+ BNDLS.
S-3927P	3/16"	Lightweight Products	12" x 750'	24	4	\$49 per roll any bundle quantity			
S-8277P			16" x 750'		3	\$88	\$83	\$78	\$72
S-3928P			24" x 750'		2	130	122	114	106
S-3929P			48" x 750'		1	260	243	229	212
S-6683P	5/16"	Semi-Rugged Products	12" x 375'	18	4	39	37	34	30
S-8278P			16" x 375'		3	51	48	45	42
S-6684P			24" x 375'		2	78	72	66	62
S-6685P			48" x 375'		1	154	146	132	124
S-3930P	1/2"	Dunnage, Void Fill	12" x 250'	15	4	\$24 per roll any bundle quantity			
S-8279P			16" x 250'		3	41	39	37	32
S-3931P			24" x 250'		2	\$48 per roll any bundle quantity			
S-3932P			48" x 250'		1	119	110	106	97



Uline's best value for barrier bubble.

- Excellent void fill for one-way packages, quick shipping cycles.
- Available in 3/16", 5/16" and 1/2" bubble.
- Custom sizes – Order online at [uline.com](http://uline.com)

NON-PERFORATED ROLLS **SOLD IN FULL BUNDLES**

MODEL NO.	BUBBLE SIZE	BUBBLE USE	ROLL SIZE	LBS./BNDL.	ROLLS/BNDL.	PRICE PER ROLL			
						1 BNDL.	2 BNDLS.	3 BNDLS.	4+ BNDLS.
S-3927	3/16"	Lightweight Products	12" x 750'	24	4	\$65	\$61	\$58	\$53
S-3928			24" x 750'		2	130	122	114	106
S-3929			48" x 750'		1	260	243	229	212
S-6683	5/16"	Semi-Rugged Products	12" x 375'	18	4	39	37	34	30
S-6684			24" x 375'		2	78	72	66	62
S-6685			48" x 375'		1	154	146	132	124
S-3930	1/2"	Dunnage, Void Fill	12" x 250'	15	4	29	27	26	24
S-3931			24" x 250'		2	60	56	53	48
S-3932			48" x 250'		1	119	110	106	97

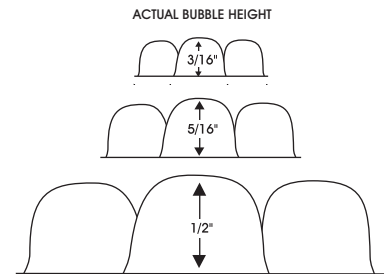

SHIPS VIA MOTOR FREIGHT

# ULINE HEAVY DUTY BUBBLE

The strongest bubble available. **3 times stronger** than our Bubble Wrap® Strong.

- 1/2" heavy-duty bubble gives maximum protection for extreme shipping conditions.
- Recommended for shipping motors, compressors, valves and your heavier items.

PERFORATED ROLLS – Cross-perforated every 12 inches.

MODEL NO.	BUBBLE SIZE	ROLL SIZE	LBS./BUNDLE	ROLLS/BUNDLE	PRICE PER ROLL (SOLD IN FULL BUNDLES)			
					1 BNDL.	2 BNDLS.	3 BNDLS.	4+ BNDLS.
S-7541P	1/2"	12" x 250'	48	4	\$75	\$70	\$66	\$63
S-7542P		24" x 250'		2	150	141	132	126
S-8035P		48" x 250'		1	300	282	265	251

SHIPS VIA MOTOR FREIGHT

NON-PERFORATED ROLLS MEETS FED. SPEC. PPP-C-795D-Class 1

MODEL NO.	BUBBLE SIZE	ROLL SIZE	LBS./BUNDLE	ROLLS/BUNDLE	PRICE PER ROLL (SOLD IN FULL BUNDLES)			
					1 BNDL.	2 BNDLS.	3 BNDLS.	4+ BNDLS.
S-7541	1/2"	12" x 250'	48	4	\$75	\$70	\$66	\$63
S-7542		24" x 250'		2	150	141	132	126
S-8035		48" x 250'		1	300	282	265	251

SHIPS VIA MOTOR FREIGHT







## FOR HEAVY DUTY, LONG SHIP CYCLES

- Superior protection for fragile, valuable items with long ship cycles.
- Long lasting, heavy-duty nylon barrier layer.
- Ships via motor freight.
- Price per roll, sold in full bundle quantities.
- MEETS FED. SPEC. PPP-C-795D-Class 1

### CALL FOR VOLUME QUOTES

ACTUAL BUBBLE HEIGHT

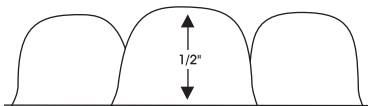
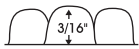

## LARGE VOLUME OR SPECIAL QUOTES? SAME DAY SERVICE!

- Special orders.
- Large volume orders.
- Custom widths.
- Items not in our current catalog.

### PERFORATED ROLLS – Cross-perforated every 12" for easy tear-off. **SOLD IN FULL BUNDLES**

MODEL NO.	BUBBLE SIZE	BUBBLE USE	ROLL SIZE	LBS./BNDL.	ROLLS/BNDL.	PRICE PER ROLL			
						1 BNDL.	2 BNDLS.	3 BNDLS.	4+ BNDLS.
S-305P	3/16"	Electronic Components	12" x 750'	43	4	\$100	\$95	\$90	\$86
S-2863P			16" x 750'		3	132	126	120	113
S-306P		Spare Parts	24" x 750'		2	198	190	181	172
S-2596P			48" x 750'		1	397	379	361	344
S-344P	5/16"	Semi-Rugged Products	12" x 375'	25	4	66	62	58	53
S-2864P			16" x 375'		3	89	84	78	71
S-2086P		24" x 375'	2		132	124	114	106	
S-2597P		48" x 375'	1		265	247	229	212	
S-307P	1/2"	Glassware, Instruments	12" x 250'	21	4	57	53	49	45
S-2089P			16" x 250'		3	75	70	66	61
S-308P		Excellent Void Fill	24" x 250'		2	\$90 per roll any bundle quantity			
S-2598P			48" x 250'		1	225	212	198	181

### NON-PERFORATED ROLLS

**SOLD IN FULL BUNDLES**

MODEL NO.	BUBBLE SIZE	BUBBLE USE	ROLL SIZE	LBS./BNDL.	ROLLS/BNDL.	PRICE PER ROLL			
						1 BNDL.	2 BNDLS.	3 BNDLS.	4+ BNDLS.
S-305	3/16"	Electronic Components	12" x 750'	43	4	\$100	\$95	\$90	\$86
S-306			24" x 750'		2	198	190	181	172
S-2596		Spare Parts	48" x 750'		1	397	379	361	344
S-344	5/16"	Semi-Rugged Products	12" x 375'	25	4	66	62	58	53
S-2086			24" x 375'		2	132	124	114	106
S-2597		48" x 375'	1		265	247	229	212	
S-307	1/2"	Glassware, Instruments	12" x 250'	21	4	57	53	49	45
S-308			24" x 250'		2	112	106	100	90
S-2598		Excellent Void Fill	48" x 250'		1	225	212	198	181



**PERFORATED ROLLS** – Cross-perforated every 12" for easy tear-off. **SOLD IN FULL BUNDLES**

MODEL NO.	BUBBLE SIZE	BUBBLE USE	ROLL SIZE	LBS./BNDL.	ROLLS/BNDL.	PRICE PER ROLL			
						1 BNDL.	2 BNDLS.	3 BNDLS.	4+ BNDLS.
S-309P	3/16"	Lightweight Products	12" x 750'	28	4	\$83	\$77	\$73	\$68
S-2088P			16" x 750'		3	111	102	98	92
S-310P		Interleaving	24" x 750'		2	165	155	145	136
S-1236P			48" x 750'		1	330	310	292	272
S-365P	5/16"	Semi-Rugged Products	12" x 375'	24	4	50	47	44	41
S-2251P			16" x 375'		3	67	64	59	53
S-1869P			24" x 375'		2	99	95	88	79
S-2252P			48" x 375'		1	199	189	175	161
S-311P	1/2"	Dunnage, Void Fill	12" x 250'	19	4	39	35	32	30
S-2090P			16" x 250'		3	51	48	45	43
S-312P			24" x 250'		2	\$62 per roll any bundle quantity			
S-1237P			48" x 250'		1	151	141	131	121

**FOR MEDIUM DUTY, SHORT SHIP CYCLES**

- Economical nylon barrier layer.
- All sizes in stock, ready for immediate shipment.
- Ships via motor freight.
- Price per roll, sold in full bundle quantities.
- See page 741 for Anti-Static Bubble.

**NON-PERFORATED ROLLS**

**SOLD IN FULL BUNDLES**

MODEL NO.	BUBBLE SIZE	BUBBLE USE	ROLL SIZE	LBS./BNDL.	ROLLS/BNDL.	PRICE PER ROLL			
						1 BNDL.	2 BNDLS.	3 BNDLS.	4+ BNDLS.
S-309	3/16"	Lightweight Products	12" x 750'	28	4	\$83	\$77	\$73	\$68
S-2088			16" x 750'		3	111	102	98	92
S-310		Interleaving	24" x 750'		2	165	155	145	136
S-1236			48" x 750'		1	330	310	292	272
S-365	5/16"	Semi-Rugged Products	12" x 375'	24	4	50	47	44	41
S-2251			16" x 375'		3	67	64	59	53
S-1869			24" x 375'		2	99	95	88	79
S-2252			48" x 375'		1	199	189	175	161
S-311	1/2"	Dunnage, Void Fill	12" x 250'	19	4	39	35	32	30
S-2090			16" x 250'		3	51	48	45	43
S-312			24" x 250'		2	75	70	66	62
S-1237			48" x 250'		1	151	141	131	121

**NEED A CUSTOM WIDTH?**

Uline will slit and ship the same day.

Special perforations, allow 1 week for delivery.

48" wide rolls can be slit into any combination of widths totaling 48".

Rolls shipped from location nearest you. Save on shipping charges.

Special quotes or large volume orders, call Customer Service.





# SUPER DUTY BUBBLE BAGS



SELF-SEAL



**3RD WEB BUBBLE –**  
Bubble sandwiched between smooth poly. Lets product slide in easily.

Maximum protection for heavy or fragile items.

- Large 5/16" bubble for extra cushioning.
- Convenient peel-and-seal closure. No taping.
- Heavy duty – 2 polyethylene layers protect and allow product to slide in easily.

MODEL NO.	INSIDE W x L	BUBBLE SIZE	QTY./ CTN.	LBS./ CTN.	PRICE PER CARTON			
					1	5	10	20+
S-15664	6 x 8"	5/16"	250	9	\$112	\$107	\$103	\$97
S-15665	8 x 11"		250	13	173	166	159	151
S-15666	12 x 15"		125	12	153	146	140	133
S-15667	18 x 23"		50	12	110	105	101	95

# HEAVY DUTY BUBBLE BAGS ON A ROLL



SELF-SEAL

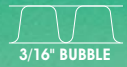

Quick and easy-to-use bags on a roll for sturdy to fragile items.

- Products slide easily over smooth inside surface.
- 1 1/4" lip with peel-and-seal closure. No need for tape.

MODEL NO.	INSIDE W x L	BAGS/ CTN.	ROLLS/ CTN.	PRICE PER CARTON			
				1	2	3	4+
S-10593	4 x 5"	1,125	3	\$154	\$146	\$143	\$138
S-12616	4 x 7"	1,125	3	190	184	180	172
S-10594	5 x 6"	900	3	156	151	144	140
S-10595	6 x 8"	500	2	124	121	118	114
S-10596	8 x 11"	376	2	149	142	138	133
S-14609	9 x 12"	316	2	160	153	149	144
S-10597	12 x 15"	125	1	140	132	129	123

# RECLOSABLE BUBBLE BAGS



Protect delicate items from dust and moisture with **reusable** bubble bags.

- Heavy-duty 3/16" bubble in between two layers of 4 mil poly.
- Double-track zipper for extra secure seals.

MODEL NO.	INSIDE W x L	BUBBLE SIZE	LBS./ CTN.	PRICE PER CTN. OF 50			
				1	5	10	20+
S-5097	4 x 6"	3/16"	3	\$80	\$77	\$72	\$68
S-5098	6 x 8"		3	91	86	83	79
S-5099	8 x 10"		5	115	109	104	98
S-5100	8 x 12"		6	122	116	110	104
S-5101	10 x 12"		7	130	122	116	110
S-5102	12 x 12"		8	138	131	125	118
S-14610	12 x 15"		9	145	138	131	124

SHIPS VIA UPS

# SLIDE-RITE® BUBBLE BAGS

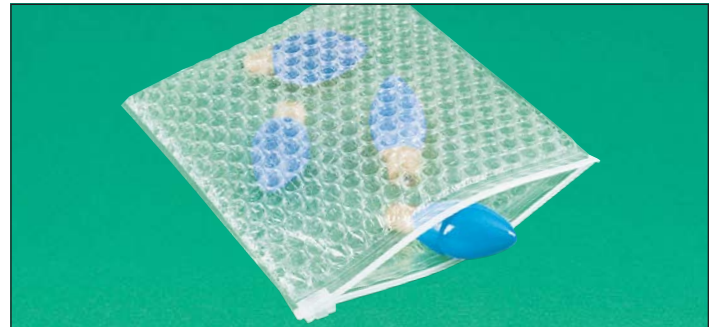

Easy-to-use Slide-Rite® closure for extra secure, safe seals.

- Heavy-duty 3/16" bubble in between two layers of 3 mil poly.
- Protect delicate items from dust and moisture with reusable bubble bags.

MODEL NO.	OUTSIDE W x L	BUBBLE SIZE	LBS./ CTN.	PRICE PER CTN. OF 50			
				1	5	10	20+
S-7579	7 x 8"	3/16"	2	\$62	\$60	\$56	\$53
S-7580	11 x 8"		3	82	78	74	70
S-7581	11 x 12"		4	94	89	83	77
S-7582	16 x 12"		6	103	97	91	85

SHIPS VIA UPS



# ULINE OPEN END BUBBLE BAGS



## ECONOMICAL

A Uline exclusive.

- Recommended for protecting irregularly-shaped items.

MODEL NO.	OUTSIDE W x L	QTY./ CTN.	LBS./ CTN.	PRICE PER CARTON			
				1	5	10	20+
S-13681	2 x 2"	1,000	3	\$109	\$105	\$101	\$96
S-10548	3 x 3"	1,000	5	86	83	80	76
S-7574	3 x 5"	1,000	7	87	84	81	78
S-10549	4 x 5"	1,000	10	89	85	82	79
S-5459	4 x 6"	1,000	12	90	86	83	80
S-12846	4 x 8"	1,000	14	96	92	88	85
S-13682	4 x 10"	500	10	65	63	60	58
S-14756	5 x 6"	1,000	9	104	100	96	91
S-12847	6 x 6"	650	9	72	69	67	64
S-5990	6 x 8"	650	13	111	107	103	98
S-10550	6 x 9"	650	15	113	109	105	101
S-8286	6 x 15"	400	13	100	95	91	87
S-8287	7 x 9"	500	14	112	108	104	100
S-10551	8 x 10"	500	13	114	110	106	102
S-7575	8 x 11"	350	14	84	81	78	74
S-5460	9 x 12"	350	15	104	100	96	91
S-7576	10 x 10"	350	13	103	98	95	90
S-8288	10 x 15"	250	14	82	79	75	71
S-12848	12 x 12"	200	11	67	65	62	60
S-7577	12 x 15"	200	14	93	90	86	83
S-5461	12 x 18"	200	15	96	92	88	85
S-8289	15 x 15"	200	17	106	103	98	93
S-5991	15 x 18"	150	16	95	91	87	84
S-8290	18 x 24"	100	16	86	83	80	76
S-6151	24 x 24"	75	15	98	93	90	86
S-14757	24 x 30"	50	9	70	67	65	62
S-10552	30 x 30"	50	16	93	90	86	83
S-8291	36 x 24"	50	15	90	86	83	80
S-10553	36 x 36"	30	15	57	54	51	49
S-13683	36 x 48"	10	7	39	38	36	35

# ULINE SELF-SEAL BUBBLE BAGS



Cushion and protect fragile items without tape.

- 1/2" peel-and-seal tape for hassle-free closing.

MODEL NO.	INSIDE W x L	QTY./ CTN.	LBS./ CTN.	PRICE PER CARTON			
				1	5	10	20+
S-10546	3 x 3½"	1,000	5	\$106	\$100	\$97	\$94
S-14758	3 x 5"	1,000	5	112	107	101	97
S-13679	3 x 10"	500	7	95	91	88	84
S-14759	4 x 4"	1,000	5	113	108	102	99
S-680	4 x 5½"	1,000	8	113	108	102	99
S-681	4 x 7½"	500	6	69	67	65	63
S-14760	4 x 12"	400	6	118	113	110	105
S-5140	5 x 6"	450	7	78	76	73	70
S-14761	5 x 8"	450	6	99	96	92	89
S-5456	5 x 10½"	250	5	72	68	66	64
S-15689	6 x 6½"	500	6	101	98	95	91
S-682	6 x 8½"	250	6	54	52	51	48
S-10547	6 x 11½"	250	8	84	79	77	74
S-5141	6 x 15½"	250	9	106	100	97	94
S-13680	6 x 20"	250	11	118	113	110	105
S-2865	7 x 8½"	250	4	74	72	68	66
S-2866	7 x 11½"	250	9	97	94	90	87
S-683	8 x 11½"	450	11	138	131	125	120
S-695	8 x 15½"	350	12	144	140	134	125
S-2867	8 x 17½"	250	13	138	131	125	120
S-6152	9 x 13½"	350	13	139	132	128	121
S-5457	10 x 10½"	250	13	98	95	91	88
S-684	10 x 15½"	250	11	130	124	120	116
S-2868	12 x 11½"	250	11	138	131	125	120
S-1210	12 x 15½"	200	12	118	113	110	105
S-14762	12 x 18"	200	11	125	121	117	112
S-1211	12 x 23½"	150	13	111	106	100	96
S-5458	15 x 15½"	150	13	111	106	100	96
S-696	15 x 17½"	150	11	112	107	101	97
S-2369	18 x 23½"	100	12	111	106	100	96



## BUBBLE TUBING

Protects odd-shaped or long items.

- Recommended for metal tubing, wood moulding or blinds.
- Use Heat Sealers to custom-make bubble bags, pages 154-155.

MODEL NO.	BUBBLE SIZE	INSIDE W x L	LBS./ROLL	PRICE PER ROLL		
				1	3	6+
S-23553	3/16"	3" x 100'	1	\$64	\$61	\$58
S-10589		4" x 100'	2	67	64	61
S-10590		6" x 100'	3	74	69	66
S-12618		8" x 100'	4	81	76	71
S-14583		10" x 100'	4	86	82	78
S-10591		12" x 100'	5	89	85	81
S-12619		16" x 100'	8	107	102	96
S-10592		24" x 100'	10	128	122	114

## PORTABLE ROLL STANDS



Move, cut and store your foam or bubble easily.

- Heavy-duty steel frame with cutting surface and 3" locking casters.
- Tensioner prevents unraveling.
- Easy 4-screw assembly.

MODEL NO.	MAXIMUM WIDTH	MAXIMUM DIAMETER	PRICE EACH	
			1	2+
H-1187	24"	40"	\$159	\$149
H-1034	48"		200	190

## PACKING RACKS

Dispense rolls of bubble, foam or wadding.

- Sets up in minutes.
- Steel construction.
- Holds rolls up to 48" in diameter.



MODEL NO.	ARM WIDTH	CAPACITY	PRICE EACH	
			1	2+
H-251	12"	Two 12" rolls	\$81	\$76
H-252	24"	Two 24" rolls	90	85

## FOAM PROTECTION

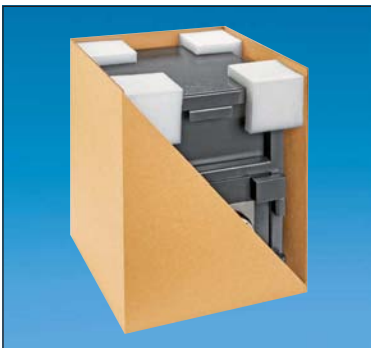

**Corner Guards** – Prevent corner damage from shock and vibrations. Water resistant.

- Low-density closed cell plank foam resists tearing and crumbling.

**Starch Foam Sheets** – Flexible. Wrap around corners and curves of fragile items. Static-free.

- Biodegradable foam decomposes in water leaving no waste.



### CORNER GUARDS

MODEL NO.	INSIDE DIM. L x W x H	DENSITY/ CUBIC FT.	THICK-NESS	QTY./ CTN.	PRICE PER CARTON	
					1	5+
S-23844	2 x 2 x 2"	1.7 lbs.	1"	64	\$115	\$110
S-23845	4 x 4 x 4"				185	175

### STARCH FOAM SHEETS

MODEL NO.	SHEET SIZE L x W x H	DENSITY/ CUBIC FT.	TEMP. RANGE	SHEETS/ CTN.	PRICE PER CARTON		
					1	3	5+
S-23846	12 x 12 x 1"	1.8 lbs.	-10° to +215°F	40	\$65	\$62	\$60
S-23847	12 x 12 x 2"			20			
S-23848	24 x 24 x 1"	1.8 lbs.	-10° to +215°F	10	65	62	60
S-23849	24 x 24 x 2"			5			

# MINI PAK'R™ AIR CUSHION MACHINE



**MAKES 25 FEET PER MINUTE!**

Simple, efficient and easy to use. Recommended for businesses shipping up to 150 packages per day.

- Automatically selects film setting for void fill, wrapping, cushioning.
- Fast. Makes 25 feet of void fill per minute.
- Perforated for easy tear-off.
- Space saving, compact. Well worth the initial one-time cost.

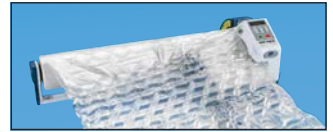

Shown with H-3933 Support Arm

**S-19536 – 2x wider than standard large bubble quilt.**

**MACHINE – UL Listed**

**1 YEAR WARRANTY**

MODEL NO.	DESCRIPTION	DIMENSIONS L x W x H	SHPG. WT.	PRICE EACH
H-1604	Mini Pak'r™	14 x 13 x 12"	15 lbs.	\$1,500
H-3933	Wide Roll Support Arm Kit for S-19536 24" Film Roll	33 x 5 x 7"	8 lbs.	199



Air Pillows



Small Bubble Quilt



Large Bubble Quilt



Double Cushion



Supertube



Ideal for wrapping, interleaving.

## AIR CUSHIONING FILM – LOW DENSITY

MODEL NO.	DESCRIPTION	SUGGESTED USE	CUSHION SIZE	MIL	ROLL SIZE W x L	ROLLS/ CTN.	PRICE PER ROLL		
							1	2	6+
S-12881* S-12882*	Air Pillows	Blocking, Bracing and Void Fill	8 x 4" 8 x 8"	1.2	8" x 1,066'	2	N/A	\$98	\$96
S-12883 S-12884	Small Bubble Quilt Large Bubble Quilt	Wrapping, Cushioning and Interleaving	1/2 x 6 x 12" 1 1/4 x 6 x 12"	1.8	16" x 656'	1	\$128	126	123
S-19536•	Large Bubble Quilt		1 1/4 x 6 x 24"	1.2	29" x 640'		119	117	113
S-12885 S-15959	Double Cushion Pillow Supertube	Heavy Duty Void Fill and Bracing	Two – 6 x 7" Four – 2 1/2 x 7"	1.8	16" x 656'	1	128	126	123

\* Sold in carton quantities • Requires Support Arm Kit

## ULINE AIR PILLOW MACHINE

Produce a high volume of air pillows on demand. For shipping up to 300 packages per day.

- Super fast. Makes 50 feet of pillows per minute.
- Easily adjustable to control air fill and bag count.
- LED panel display.



**MAKES 50 FEET PER MINUTE!**

**MACHINE**

**1 YEAR WARRANTY**

MODEL NO.	DESCRIPTION	DIMENSIONS L x W x H	SHPG. WT.	PRICE EACH
H-3518	Uline Air Pillow Machine	14 x 12 x 11"	24 lbs.	\$2,490

## AIR PILLOW FILM – HIGH DENSITY

MODEL NO.	DESCRIPTION	SUGGESTED USE	CUSHION SIZE	MIL	ROLL SIZE W x L	ROLLS/ CTN.	PRICE PER ROLL		
							1	2	6+
S-18597 S-18598	Eco-friendly Green Air Pillows	Blocking, Bracing and Void Fill	8 x 4" 8 x 8"	1.0	8" x 1,640'	1	\$73	\$71	\$69
S-18722	Green Long Tubes	Wrapping, Cushioning and Interleaving	16 x 2"		16" x 1,066'		93	91	89
S-18723 S-18724	Clear Air Pillows	Blocking, Bracing and Void Fill	8 x 4" 8 x 8"	1.0	8" x 1,640'	1	73	71	69





## SUPER DUTY BUBBLE

Heavy duty, three-layer construction for shipping heavy or sharp items.

- Recommended for protecting tools, auto parts and metal cabinets.
- Highest tear and puncture resistance of all bubble.
- Extra layer keeps bubble from going flat.
- Smooth on both sides for easy labeling.

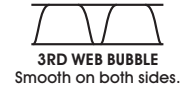

### NON-PERFORATED ROLLS

MODEL NO.	BUBBLE SIZE	ROLL SIZE	LBS./ROLL	PRICE PER ROLL			
				1	3	6	10+
S-20052	3/16"	12" x 300'	8	\$54	\$50	\$47	\$44
S-20053		24" x 300'	15	104	97	91	85
S-20054	1/2"	12" x 125'	4	41	39	37	35
S-20055		24" x 125'	8	74	70	65	61

### PERFORATED ROLLS – Cross perforated every 12 inches.

MODEL NO.	BUBBLE SIZE	ROLL SIZE	LBS./ROLL	PRICE PER ROLL			
				1	3	6	10+
S-20052P	3/16"	12" x 300'	8	\$54	\$50	\$47	\$44
S-20053P		24" x 300'	15	104	97	91	85
S-20054P	1/2"	12" x 125'	4	41	39	37	35
S-20055P		24" x 125'	8	74	70	65	61

## UPSABLE ECO-FRIENDLY BUBBLE



Green alternative to traditional bubble with the same protection.

- Up to 40% recycled content with up to 20% from post-consumer sources.
- Transparent color allows wrapped items to be seen.

### PERFORATED ROLLS – Cross perforated every 12 inches.

MODEL NO.	BUBBLE SIZE	ROLL SIZE	LBS./ROLL	PRICE PER ROLL			
				1	3	6	10+
S-19331P	3/16"	12" x 300'	4	\$36	\$34	\$30	\$28
S-19332P		24" x 300'	7	67	63	60	56
S-19333P	1/2"	12" x 125'	3	26	24	23	22
S-19334P		24" x 125'	6	48	46	43	40

## UPSABLE BLACK BUBBLE



Stylish and eco-friendly. Cushioning your customers will notice.

- Contains up to 40% recycled content.
- Same quality and protection as traditional bubble.
- Dark color conceals item until unwrapped.

### PERFORATED ROLLS – Cross perforated every 12 inches.

MODEL NO.	BUBBLE SIZE	ROLL SIZE	LBS./ROLL	PRICE PER ROLL			
				1	3	6	10+
S-20056P	3/16"	12" x 300'	4	\$39	\$37	\$35	\$32
S-20057P		24" x 300'	7	72	68	65	61
S-20058P	1/2"	12" x 125'	3	29	27	26	25
S-20059P		24" x 125'	6	54	51	48	45

## PICK AND PACK FOAM

Create custom foam cushioning without cutting.

- Easily pull out perforated foam squares to match product's shape.
- Charcoal soft urethane foam conforms to fragile and valuable items in all directions.

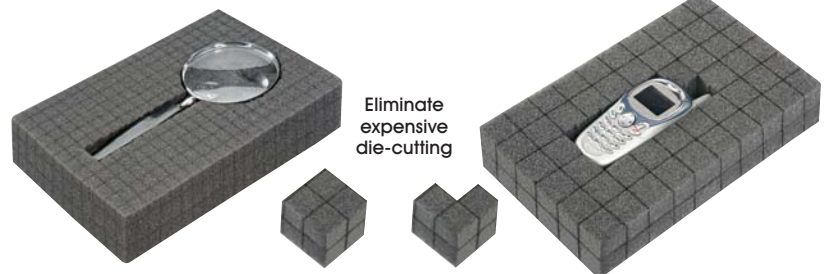

Eliminate expensive die-cutting

### 1/2 x 1/2" PERFORATED SQUARES

MODEL NO.	SHEET SIZE L x W x H	SHEETS/CTN.	SOLD IN CARTON QUANTITIES		
			PRICE PER SHEET		
			1 CTN.	3 CTNS.	6+ CTNS.
S-15695	24 x 24 x 1/2"	24	\$8.00	\$7.75	\$7.50
S-14642	24 x 24 x 1"	12	14.00	13.50	13.00
S-14643	24 x 24 x 2"	6	25.00	24.00	23.00
S-22368	24 x 24 x 3"	4	37.00	36.00	35.00
S-23019	24 x 24 x 4"	3	49.00	48.00	47.00

### 1 x 1" PERFORATED SQUARES

MODEL NO.	SHEET SIZE L x W x H	SHEETS/CTN.	SOLD IN CARTON QUANTITIES		
			PRICE PER SHEET		
			1 CTN.	3 CTNS.	6+ CTNS.
S-15696	24 x 24 x 1/2"	24	\$7.25	\$7.00	\$6.75
S-13718	24 x 24 x 1"	12	12.00	11.75	11.25
S-13719	24 x 24 x 2"	6	23.00	22.00	21.00
S-22369	24 x 24 x 3"	4	35.00	34.00	33.00
S-23020	24 x 24 x 4"	3	48.00	47.00	46.00

# SOFT FOAM

## ROLLS

MODEL NO.	ROLL SIZE W x L	THICKNESS	WEIGHT/ROLL	PRICE PER ROLL		
				1	3	6+
S-8350	24" x 72 ft.	1/2"	12 lbs.	\$130	\$124	\$120
S-8349	12" x 36 ft.		7 lbs.	67	64	61
S-7546	24" x 36 ft.	1"	11 lbs.	130	124	114
■S-7549	36" x 36 ft.		16 lbs.	172	161	150
S-11747	12" x 18 ft.		7 lbs.	66	63	60
S-10017	24" x 18 ft.	2"	12 lbs.	118	111	102
S-11748	24" x 12 ft.	3"	12 lbs.	151	145	135

■ SHIPS VIA MOTOR FREIGHT



Quickly cushions odd-shaped or delicate products for shipping.

- Foam is incredibly soft and cushy.
- Easily molds around products. • Reusable.
- Recommended for use as a protective wrap or void fill.

## WHITE SHEETS

## SOLD IN CARTON QUANTITIES

MODEL NO.	SIZE W x L	THICKNESS	SHEETS/CARTON	PRICE PER SHEET		
				1 CARTON	3 CARTONS	6+ CARTONS
S-19919	8 x 8"	1/2"	216	\$.75	\$.70	\$.65
S-12835	12 x 12"		96	1.05	1.00	.95
S-13713	6 x 6"	1"	96	.80	.75	.70
S-11749	12 x 12"		48	2.20	2.10	2.00
S-11750	24 x 24"		12	8.15	7.65	7.20
■S-12836	48 x 96"		3	56.00	50.00	47.00
S-12837	12 x 12"	2"	24	4.15	3.90	3.55
S-12838	24 x 24"		6	16.00	15.00	14.00
S-13714	48 x 96"		1	95.00	91.00	87.00
S-13715	12 x 12"		16	6.50	6.15	5.80

■ SHIPS VIA MOTOR FREIGHT

## CHARCOAL SHEETS

## SOLD IN CARTON QUANTITIES

MODEL NO.	SIZE W x L	THICKNESS	SHEETS/CARTON	PRICE PER SHEET		
				1 CARTON	3 CARTONS	6+ CARTONS
S-15661	12 x 12"	1/2"	96	\$1.15	\$1.05	\$1.00
S-12839	12 x 12"	1"	48	2.30	2.20	2.10
S-12840	24 x 24"		12	8.35	7.80	7.35
S-13716	12 x 12"	2"	24	4.30	4.05	3.75
S-13717	24 x 24"		6	13.20	12.50	11.45
S-15662	48 x 96"		1	96.00	91.00	86.00

# CONVOLUTED FOAM SETS

## SOLD IN CARTON QUANTITIES

MODEL NO.	SHEET SIZE L x W x H	TYPE OF FOAM	SETS/CARTON	PRICE PER SET		LBS./CTN.
				1 CARTON	3+ CARTONS	
S-12789	6 x 6 x 2"	Charcoal	64	\$1.25	\$1.15	6
S-6435	8 x 6 x 2"		48	2.10	1.90	5
S-11751	10 x 10 x 2"		24	2.95	2.75	6
S-8394	12 x 12 x 2"		24	4.10	3.80	8
S-6436	16 x 16 x 2"		12	6.20	5.65	7
S-6437	24 x 24 x 2"		6	12.40	11.65	8
S-6438	24 x 36 x 2"		9	15.65	14.70	16
S-15663*	24 x 36 x 4"		4	32.00	30.00	14
S-14641	48 x 96 x 2"		1	102.00	95.00	11

\* Total set height is 4"; base, 1 1/2"

Cut thick convoluted polyurethane to the size you need.

- Total set height is 2"; base, 3/4".
- Sets are 2 sheets of interlocking foam.
- Anti-static Convoluted Foam, see page 749.



# CHARCOAL FOAM SHIPPERS

## SOLD IN CASE QUANTITIES

MODEL NO.	SIZE L x W x H	TYPE OF FOAM	BOXES/CASE	PRICE PER SHIPPER		
				9-24	48	96+
S-6439	8 x 8 x 2 3/4"	Charcoal	24	\$6.90	\$6.30	\$5.85
S-6440	12 x 12 x 4"		24	11.55	10.65	9.80
S-6441	16 x 16 x 2 3/4"		12	13.30	12.40	11.35
S-8510	24 x 24 x 2 3/4"		9	23.05	21.25	19.40

Holds fragile items in place and prevents slipping.

- Ideal for picture frames, glassware and collectibles.
- Locking tabs for added security.



# ULINE FOAM ROLLS



## FOAM ROLLS

SOLD IN FULL BUNDLES

MODEL NO.	ROLL THICKNESS	ROLL SIZE	ROLLS/BNDL.	SUGGESTED USES	WT./BNDL.	PRICE PER ROLL		
						1 BNDL.	2 BNDLS.	3+ BNDLS.
S-2599	1/32"	6" x 2,000'	12	Injection-molded parts for autos, appliances, computer housings	54 lbs.	\$30	\$28	\$27
S-1094		12" x 2,000'	6			61	59	56
S-3232		18" x 2,000'	4			92	88	84
S-1095		24" x 2,000'	3			122	117	110
S-1096		36" x 2,000'	2			183	175	167
S-1980		48" x 2,000'	1			243	232	221
S-1097		72" x 2,000'	1			365	348	331
S-2479	1/16"	6" x 1,250'	12	Finished surfaces, china, glass	54 lbs.	29	28	27
S-785		12" x 1,250'	6			61	58	56
S-2480		18" x 1,250'	4			91	87	83
S-787		24" x 1,250'	3			120	116	109
S-1098		36" x 1,250'	2			182	173	166
S-1981		48" x 1,250'	1			239	228	217
S-1099		72" x 1,250'	1			360	343	326
S-2600	3/32"	6" x 750'	12	Plaques, pictures, metal parts	43 lbs.	26	25	24
S-1571		12" x 750'	6			53	50	48
S-3233		18" x 750'	4			80	76	70
S-1572		24" x 750'	3			105	98	93
S-1573		36" x 750'	2			155	148	141
S-1982		48" x 750'	1			204	195	184
S-1574		72" x 750'	1			309	293	279
S-2481	1/8"	6" x 550'	12	Furniture, optical lenses, aircraft parts, food products, pharmaceuticals	40 lbs.	23	22	21
S-3952		8" x 550'	9			29	28	27
S-786		12" x 550'	6			46	44	41
S-2482		18" x 550'	4			67	64	61
S-788		24" x 550'	3			91	87	83
S-1100		36" x 550'	2			134	128	122
S-1983		48" x 550'	1			182	173	164
S-1101	72" x 550'	1	269	256	243			
S-2601	1/4"	6" x 250'	12	Interleaving between heavy products	40 lbs.	23	22	21
S-1852		12" x 250'	6			47	45	42
S-3234		18" x 250'	4			68	65	62
S-1853		24" x 250'	3	93		89	85	
S-1854		36" x 250'	2	137		130	124	
S-1956		48" x 250'	1	184		176	168	
S-1855		72" x 250'	1	273		260	247	
S-11776	1/2"	12" x 125'	4	Heavy pumps, light fixtures, sharp edged products	39 lbs.	83	79	75
S-11777		24" x 125'	2			164	154	148
S-11778		48" x 125'	1			323	308	292

Protect delicate items for shipment and storage with low cost, shock-absorbing polyethylene foam.

- Clean, non-abrasive, lightweight and waterproof.
- Meets Fed. Spec. PPP-C-1752D and A-A-59135.
- 1/2" size – Thick foam provides cushioning, surface protection and void fill.

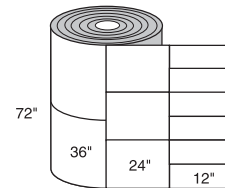

## NEED A CUSTOM WIDTH?

- Uline will slit and ship within 24 hours.
- Let us know the width you need. Add 5% to the 72" bundle price.



SHIPS VIA MOTOR FREIGHT. OTHER WIDTHS AVAILABLE UPON REQUEST.



# ULINE PERFORATED FOAM ROLLS

SOLD IN FULL BUNDLES

MODEL NO.	ROLL THICKNESS	ROLL SIZE	ROLLS/BNDL.	SUGGESTED USES	WT./BNDL.	PRICE PER ROLL				
						1 BNDL.	2 BNDLS.	3+ BNDLS.		
S-2599P	1/32"	6" x 2,000'	12	Injection-molded parts for autos, appliances, computer housings	54 lbs.	\$30	\$28	\$27		
S-1094P		12" x 2,000'	6			61	59	56		
S-3232P		18" x 2,000'	4			92	88	84		
S-1095P		24" x 2,000'	3			122	117	110		
S-1096P		36" x 2,000'	2			183	175	167		
S-1980P		48" x 2,000'	1			243	232	221		
S-1097P		72" x 2,000'	1			365	348	331		
S-2479P	1/16"	6" x 1,250'	12	Finished surfaces, china, glass	54 lbs.	29	28	27		
S-785P		12" x 1,250'	6			\$56 per roll any bndl. qty.				
S-2480P		18" x 1,250'	4			91	87	83		
S-787P		24" x 1,250'	3			\$109 per roll any bndl. qty.				
S-1098P		36" x 1,250'	2			182	173	166		
S-1981P		48" x 1,250'	1			239	228	217		
S-1099P		72" x 1,250'	1			360	343	326		
S-2600P	3/32"	6" x 750'	12	Plaques, pictures, metal parts	43 lbs.	26	25	24		
S-1571P		12" x 750'	6			53	50	48		
S-3233P		18" x 750'	4			80	76	70		
S-1572P		24" x 750'	3			105	98	93		
S-1573P		36" x 750'	2			155	148	141		
S-1982P		48" x 750'	1			204	195	184		
S-1574P		72" x 750'	1			309	293	279		
S-19360P	1/8"	4" x 550'	18	Furniture, optical lenses, aircraft parts, food products, pharmaceuticals	40 lbs.	20	19	18		
S-2481P		6" x 550'	12			23	22	21		
S-3952P		8" x 550'	9			29	28	27		
S-786P		12" x 550'	6			\$41 per roll any bndl. qty.				
S-2482P		18" x 550'	4			67	64	61		
S-788P		24" x 550'	3			\$83 per roll any bndl. qty.				
S-1100P		36" x 550'	2			135	128	122		
S-1983P	48" x 550'	1	\$164 per roll any bndl. qty.							
S-1101P	72" x 550'	1	269	256	243					
S-19361P	1/4"	4" x 250'	18	Interleaving between heavy products	40 lbs.	20	19	18		
S-2601P		6" x 250'	12			23	22	21		
S-1852P		12" x 250'	6			47	45	42		
S-3234P		18" x 250'	4	68		65	62			
S-1853P		24" x 250'	3	93		89	85			
S-1854P		36" x 250'	2	137		130	124			
S-1956P		48" x 250'	1	184		176	168			
S-1855P		72" x 250'	1	273		260	247			
						Electronic and video equipment				

SHIPS VIA MOTOR FREIGHT. OTHER WIDTHS AVAILABLE UPON REQUEST.



- Cross-perforated every 12".
- **Special Perforated Sizes:** Add 10% to the cost per roll. Please allow 1 week for delivery.
- Customize your rolls: order custom widths and perforations online at [uline.com](http://uline.com)

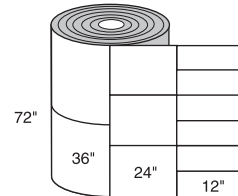

## FOAM SHEETS

Pre-cut foam is quick and easy to use for layering between fragile items.

- Non-abrasive 1/8" thick foam sheets provide excellent protection.
- Custom sizes available: Lead time 3 weeks.

MODEL NO.	SHEET THICKNESS	SIZE W x L	QTY./CTN.	LBS./CTN.	PRICE PER CARTON		
					1	3	5+
S-12622	1/8"	4 x 4"	3,200	8	\$149	\$138	\$131
S-6699		6 x 6"	3,200	15	112	104	100
S-6768		8 x 8"	1,800	15	104	98	91
S-6769		10 x 10"	800	12	72	67	63
S-6705		12 x 12"	800	13	90	83	79
S-19362		12 x 24"	400	13	85	79	74
S-19363		18 x 18"	300	9	82	75	69
S-11761		24 x 24"	200	13	89	82	78



# PLANK FOAM



Provides superior long-term cushioning and support for fragile or heavy items.

- Flexible low-density polyethylene foam is highly resilient, shatterproof and tear resistant.
- Water, fungi and mold-resistant closed cell foam.
- Perfed sheets are cut into 4 x 4" squares with peel-and-stick adhesive on one side.
- FDA compliant for indirect food contact.

Charcoal – Masks dirt and smudges.



NO ADHESIVE

## PERFED WITH ADHESIVE – WHITE

MODEL NO.	SHEET SIZE L x W x H	DENSITY/ CUBIC FT.	TEMP. RANGE	SHEETS/ CTN.	PRICE PER CARTON		
					1	3	5+
S-19390	16 x 16 x 1/2"	1.7 lbs.	-110° to +215°F	20	\$109	\$102	\$95
S-8347	16 x 16 x 1"			10	86	80	74
S-8348	16 x 16 x 2"			5	74	68	63
S-12852	16 x 16 x 3"			4	80	74	68
S-11820	24 x 24 x 1"			10	156	147	138
S-11821	24 x 24 x 2"			5	114	108	101
S-12854	24 x 24 x 3"	4	122	113	107		

## NON-PERFED, NO ADHESIVE – WHITE

S-13772	12 x 12 x 2"	1.7 lbs.	-110° to +215°F	20	\$126	\$118	\$109
S-11819	16 x 16 x 1"			10	72	67	62
S-13773	16 x 16 x 2"			5	68	64	59
S-15690	24 x 24 x 1"			10	134	125	116
S-13774	24 x 24 x 2"			5	128	119	110
S-13775	24 x 48 x 2"			5	214	201	185
■S-19391	48 x 96 x 1/2"	4	138	129	122		
■S-12855	48 x 96 x 1"	2	117	110	103		
■S-12856	48 x 96 x 2"	2	182	172	163		
■S-14586	48 x 96 x 3"	1	158	148	141		

## NON-PERFED, NO ADHESIVE – CHARCOAL

S-20810	24 x 24 x 1"	1.7 lbs.	-110° to +215°F	10	\$134	\$125	\$116
■S-20811	48 x 96 x 1"			2	117	110	103

■ SHIPS VIA MOTOR FREIGHT

# POLYSTYRENE SHEETS



Economical sheets for short-term blocking and bracing.

- Water-resistant, high-density foam is rigid yet lightweight.
- Line boxes for added protection on fragile and temperature sensitive shipments.

## FOAM HOT KNIFE



Cuts styrofoam and plank foam.

- Adjustable temperature control.

110 VOLT [More info, uline.com](http://www.uline.com)

MODEL NO.	BLADE SIZE	PRICE EACH	
		1	2+
H-1079	4"	\$290	\$270

## SOLD IN CARTON QUANTITIES

MODEL NO.	SHEET SIZE L x W x H	DENSITY/ CUBIC FT.	TEMP. RANGE	SHEETS/ CTN.	PRICE PER SHEET		
					1 CTN.	3 CTNS.	6+ CTNS.
S-19392	10 x 10 x 1/2"	1.0 lbs.	-150° to +167°F	272	\$.36	\$.34	\$.33
S-19393	10 x 10 x 1"			136	.70	.68	.67
S-19394	12 x 12 x 1/4"			416	.23	.22	.21
S-15691	12 x 12 x 1/2"			208	.39	.36	.35
S-6718	12 x 12 x 1"			104	.75	.73	.72
S-14587	12 x 12 x 2"			52	1.50	1.45	1.40
S-23554	18 x 18 x 1"			38	1.85	1.80	1.75
S-14588	24 x 24 x 1"			26	2.80	2.75	2.65
S-15692	24 x 48 x 1/2"			20	2.80	2.75	2.65
S-13776	24 x 48 x 1"			10	5.50	5.25	5.00
S-14589	24 x 48 x 2"			5	11.00	10.25	9.75
■S-23555	48 x 48 x 1"			40	11.50	10.75	10.00
■S-15693	48 x 96 x 1/2"			80	11.50	10.75	10.00
■S-13777	48 x 96 x 1"			40	23.00	21.00	20.00
■S-23556	48 x 96 x 1 1/2"			27	34.00	31.00	28.00
■S-15694	48 x 96 x 2"			20	44.00	40.00	38.00
■S-23557	48 x 96 x 3"	13	68.00	63.00	58.00		
■S-23558	48 x 96 x 4"	10	84.00	79.00	74.00		

■ SHIPS VIA MOTOR FREIGHT

# ULINE FOAM

SHIPS UPS

Portable, moves around the warehouse. • Reusable.

- Dust free, nonabrasive, shock resistant and moisture proof.

MODEL NO.	THICKNESS	ROLL SIZE	LBS./CTN.	PRICE PER CARTON			
				1	3	6	10+
S-1090	1/16"	12" x 350'	6	\$37	\$36	\$35	\$32
S-1091		24" x 350'	10	72	69	66	63
S-775	1/8"	12" x 175'	5	\$30 per carton any quantity			
S-744		24" x 175'	10	68	65	63	60
S-1092	1/4"	12" x 85'	5	38	37	36	34
S-1093		24" x 85'	8	74	70	67	64



# ULINE UPSABLE INDUSTRIAL ROLLS

\* Perforated every 12 inches

MODEL NO.	THICKNESS	ROLL SIZE	LBS./ROLL	PRICE PER ROLL		
				1	2	3+
S-12574P*	1/32"	12" x 1,200'	8	\$51	\$48	\$45
S-12575P*		24" x 1,200'	10	104	97	90
S-2963	1/16"	12" x 900'	5	61	57	53
S-2963P*		12" x 900'	6	61	57	53
S-2964		24" x 900'	11	122	112	106
S-2964P*		24" x 900'	12	122	112	106
S-2961	1/8"	12" x 350'	4	46	43	39
S-2961P*		12" x 350'	4	46	43	39
S-2962		24" x 350'	9	92	86	78
S-2962P*		24" x 350'	9	92	86	78
S-13653P*	1/4"	12" x 150'	4	42	39	37
S-13654P*		24" x 150'	8	84	78	72



Uline now offers single rolls available in the largest UPSable size.

- Ideal for lower volume users.

# ULINE FOAM POUCHES

Unbeatable protection in a convenient, lightweight bag.

- Nonabrasive 1/8" polyethylene foam.
- Custom-Size Pouches available. Approximate lead time 2-3 weeks.
- Anti-Static Foam Pouches, see [uline.com](http://uline.com)

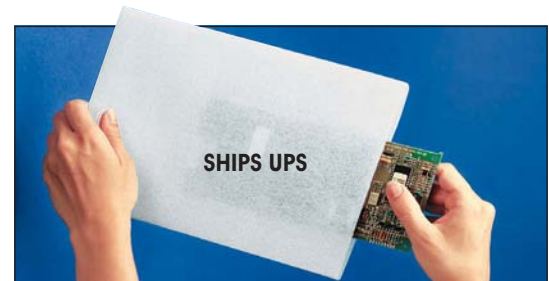

MODEL NO.	SIZE W x L	QTY./CTN.	PRICE PER CARTON		
			1	2	5+
S-12620	2 x 2"	1,000	\$59	\$54	\$50
S-8351	2 x 3"	1,000	61	57	53
S-22424	2 x 5"	500	38	35	32
S-13646	3 x 3"	1,000	74	69	64
S-3954	3 x 4"	500	50	47	44
S-12621	3 x 5"	500	53	49	46
S-14700	3 x 10"	500	68	64	60
S-3955	4 x 5"	500	57	52	49
S-11756	4 x 6"	500	57	53	49
S-5321	4 x 7"	500	60	56	51
S-14701	4 x 8"	500	68	64	60
S-8352	5 x 5"	500	67	63	59
S-1558	5 x 6"	500	68	64	60
S-5323	5 x 8"	400	61	58	53

MODEL NO.	SIZE W x L	QTY./CTN.	PRICE PER CARTON		
			1	2	5+
S-8353	6 x 7"	400	\$62	\$59	\$54
S-1559	6 x 9"	275	53	49	46
S-3956	8 x 10"	275	69	65	61
S-5327	8 x 12"	150	44	42	39
S-1560	9 x 12"	150	\$43 per carton any quantity		
S-11757	10 x 10"	150	43	41	38
S-11758	10 x 13"	150	58	54	50
S-11759	12 x 12"	150	70	66	62
S-1561	12 x 15"	150	84	79	74
S-3957	15 x 18"	75	62	58	54
S-3958	18 x 24"	75	76	70	66
S-8354	24 x 24"	50	62	58	54
S-11760	24 x 36"	50	84	79	74
S-14702	36 x 36"	30	79	72	68



# INSTANT BUBBLE ROLL MACHINE



Super fast! Pump out 600 packages a day using bubble cushioning you make yourself. One film roll equals up to 5 bundles of bubble.

- Simple, easy-to-use operation. Small footprint. Fits on tabletop.
- Makes 90 feet per minute of heavy duty nylon barrier bubble.
- Perforated every 12 inches.
- Accessories, see [uline.com](http://uline.com)



MAKES BUBBLE ROLLS

## INSTANT BUBBLE FILM

■ SHIPS VIA MOTOR FREIGHT

MODEL NO.	DESCRIPTION	SUGGESTED USE	BUBBLE SIZE	INFLATED ROLL W x L	MIL	LBS./ROLL	PRICE PER ROLL
S-19738	Medium Bubble	Wrapping, Cushioning and Interleaving	1/2"	12" x 2,050'	1	32	\$450
S-19739				24" x 2,050'		64	900
S-19740	Large Bubble		3/4"	12" x 1,250'	1.6	32	450
S-19741				24" x 1,250'		64	900
S-19742	Extra Large Bubble		1"	12" x 1,167'	1.7	32	450
S-19743						24" x 1,167'	64
■H-7259	NewAir I.B.® Flex Machine – 26 x 23 x 16" (LWH)					81 lbs.	\$4,275 each

## ANTI-SCRATCH POUCHES



Guard your Gucci, defend your Fendi.

- Protect your finest leather goods and handbags from scratches and scuffs.
- Breathable, spunbound polypropylene prevents trapped moisture.

- Strong and tear resistant with a soft, cloth-like feel.

MODEL NO.	SIZE W x L	QTY./CTN.	PRICE PER CARTON		
			1	2	5+
S-23608	5 x 8"	800	\$70	\$67	\$62
S-23609	9 x 12"	300	50	47	44
S-23610	10 x 14"	300	59	56	53

## PICK AND PACK FOAM SHIPPERS

Create custom packaging for fragile items.

- 2" thick pre-cut squares pull apart with ease to match product's shape.
- Includes 1" thick top and bottom solid foam sheets for extra cushioning.



- 200 lb. test box with locking tabs.

1 x 1" PERFORATED SQUARES

MODEL NO.	INSIDE DIM. W x L x H	QTY./CTN.	LBS./CTN.	PRICE PER SHIPPER		
				1 CTN.	2 CTNS.	5+ CTNS.
S-23611	12 x 12 x 4"	12	11	\$19	\$18	\$17
S-23612	16 x 16 x 4"	6	8	28	27	25
S-23613	26 x 18 x 4"	4	10	42	40	38

## RAPID FILL®



AIR FILLED CUSHIONING SYSTEM

Inflatable bags provide excellent void fill for your product.

- Quick: Inflate bags in just 8 seconds with no mess.
- Bags ship flat – Saves space, inflates on demand.
- Portable inflator plugs into standard 110 volt outlet.



MODEL NO.	BAG SIZE	VOLUME CAPACITY	BAGS/CTN.	PRICE PER CARTON		
				1	5	10+
S-13698	5 x 8"	0.1 cu. ft.	250	\$101	\$96	\$91
S-5234	9 x 11"	0.2 cu. ft.	250	107	100	93
S-5235	11 x 15"	0.3 cu. ft.	250	127	120	112
S-5236	14 x 18"	0.7 cu. ft.	250	186	172	158
S-5237	16 x 21"	1.1 cu. ft.	250	271	256	240
S-5238	18 x 23"	1.5 cu. ft.	250	299	289	277
S-5239	18 x 36"	2.0 cu. ft.	125	373	362	353
H-10157	Portable Inflator			\$195 each		

# INSTAPAK QUICK® ROOM TEMPERATURE

Ready to use anytime, anywhere.

- The ultimate protection for fragile shipments.
- Activate chemicals in the bag with a touch of your hands.
- Protects products of almost any size, shape and weight.
- Works best in 65° to 90°F temperatures.

**Quick Start® Kit** includes 2 of each bag size along with a user's guide, instructional CD and safety glasses.

**Heavy Duty** – Recommended for shipments 40 to 80 lbs.



1. Press firmly to open the inside seal. Pat back and forth to mix.



2. Place expanding bag inside box and nestle product onto cushion.



## QUICK START® KIT

MODEL NO.	DESCRIPTION	BAGS/CTN.	PRICE PER CARTON	
			1 CTN.	2+ CTNS.
S-19417	Room Temp Starter Kit	18	\$157	\$147

## BAGS OF EXPANDED FOAM

MODEL NO.	BAG SIZE	BAG NO.	RECOMMENDED BOX SIZE	BAGS/CTN.	PRICE/BAG (SOLD IN CARTONS)	
					1 CTN.	2+ CTNS.
S-11815	15 x 18"	#10	8 x 8 x 8"	36	\$4.50	\$3.95
S-11816	18 x 18"	#20	10 x 10 x 10"	36	5.60	4.95
S-11817	18 x 24"	#40	12 x 12 x 12"	30	7.05	6.15
S-11937*	18 x 24"	#60	14 x 14 x 14"	30	7.70	6.70
S-11818	22 x 27"	#80	18 x 12 x 12"	24	8.80	7.50
S-15672	25 x 27"	#100	16 x 16 x 16"	24	9.45	8.25

\* Contains 25% more foam for extra cushioning

## BULK PACKS

Most cost-effective way to protect your product.

- Recommended for high-volume users.



## BULK PACKS

MODEL NO.	BAG SIZE	BAG NO.	RECOMMENDED BOX SIZE	BAGS/CTN.	PRICE/BAG (SOLD IN CARTONS)	
					1 CTN.	2+ CTNS.
S-11815B	15 x 18"	#10	8 x 8 x 8"	180	\$3.20	\$3.10
S-11816B	18 x 18"	#20	10 x 10 x 10"	128	3.95	3.75
S-11817B	18 x 24"	#40	12 x 12 x 12"	112	5.15	4.85
S-11937B*	18 x 24"	#60	14 x 14 x 14"	104	5.70	5.40
S-11818B	22 x 27"	#80	18 x 12 x 12"	72	6.60	6.15
S-15672B	25 x 27"	#100	16 x 16 x 16"	72	7.35	6.80

\* Contains 25% more foam for extra cushioning

## HEAVY DUTY

MODEL NO.	BAG SIZE	BAG NO.	RECOMMENDED BOX SIZE	BAGS/CTN.	PRICE/BAG (SOLD IN CARTONS)	
					1 CTN.	2+ CTNS.
S-14594	18 x 16"	#25	10 x 10 x 10"	30	\$7.05	\$6.15
S-14595	18 x 20"	#45	12 x 12 x 12"	30	7.80	6.95
S-14596	22 x 20"	#65	14 x 14 x 14"	24	10.00	8.80

## HEAVY DUTY BULK PACKS

MODEL NO.	BAG SIZE	BAG NO.	RECOMMENDED BOX SIZE	BAGS/CTN.	PRICE/BAG (SOLD IN CARTONS)	
					1 CTN.	2+ CTNS.
S-14594B	18 x 16"	#25	10 x 10 x 10"	150	\$4.60	\$4.30
S-14595B	18 x 20"	#45	12 x 12 x 12"	120	5.40	4.85
S-14596B	22 x 20"	#65	14 x 14 x 14"	96	6.95	6.50

## COHESIVE FOAM

Protect large or small, odd-shaped items with 1/16" thick foam.

MODEL NO.	ROLL SIZE	LBS./ROLL	PRICE PER ROLL		
			1	3	6+
S-19304	6" x 250'	2	\$48	\$46	\$42
S-11822	12" x 250'	5	95	89	83
S-11823	24" x 250'	10	173	162	150

## MAKE YOUR OWN PACKAGING

- Cohesive foam sticks to itself, not the product. Leaves no residue.
- Superior puncture strength and scratch protection.
- Perforated every 6" for easy tear-off.



# VERMICULITE

Recommended for shipping liquids and chemicals.

**Grade 1** – For industrial spill cleanup and horticulture use. Most absorbent.

**Grade 2** – For packing hazardous liquids. Meets ICAA and IATA hazardous material requirements. Meets GSA CID A-A-52450.

**Grade 3** – Protects bottled liquids from damage and leakage.

**Grade 4** – Excellent absorbent and cushioning for 55-gallon overpack drums.

**Bulk Bag** – Four corner loops for hanging. Spout bottom for easy dispensing.



S-19597



GRADE 2 Hazardous Liquids



GRADE 4 Bottled Liquids

MODEL NO.	GRADE	BAG SIZE	QTY./ SKID	PRICE EACH (MIN. 2)			SKID LOTS
				2	5	10+	
S-15280	1 – Super Fine	4 cu. ft.	15	\$39	\$38	\$37	\$32
S-11569	2 – Fine			43	42	41	37
S-15281	3 – Medium			47	46	45	39
S-3393	4 – Coarse			48	47	46	41

## BULK BAG

MODEL NO.	GRADE	BAG SIZE	QTY./ SKID	PRICE EACH
S-19597	4 – Coarse	60 cu. ft.	1	\$634

# ROLL CRADLES



Secure rolls of stretch film, paper and textiles on pallets. Prevent damage and flat spots.

- 100% recycled molded pulp is firm yet pliable.
- Fold pair to use between layers. Pull apart for use on top and bottom.

Stretch Film complete line, see pages 287-297

MODEL NO.	FITS ROLL DIAMETER	SIZE L x W	CRADLE CAPACITY	QTY./ CTN.	LBS./ CTN.	PRICE PER CARTON		
						1	6	12+
S-20214	8"	46 x 12"	5 rolls	18 pairs	33	\$63	\$60	\$57
S-20215	10"	42 x 12"	4 rolls	12 pairs	18	43	41	39
S-20216	14"	44 x 14"	3 rolls	15 pairs	31	80	76	71

# KRAFT PAPER



## DISPENSER BOX

Easy to use. Just pull and tear.

- Fits easily on pack table, mobile cart or in mailroom.
- Pre-crumples kraft paper. Won't shred or unravel.

## 30 LB. BASIS WEIGHT

MODEL NO.	ROLL SIZE W x L	LBS./ CTN.	PRICE PER CARTON		
			1	3	6+
S-20213	12" x 1,500'	15	\$33	\$32	\$31

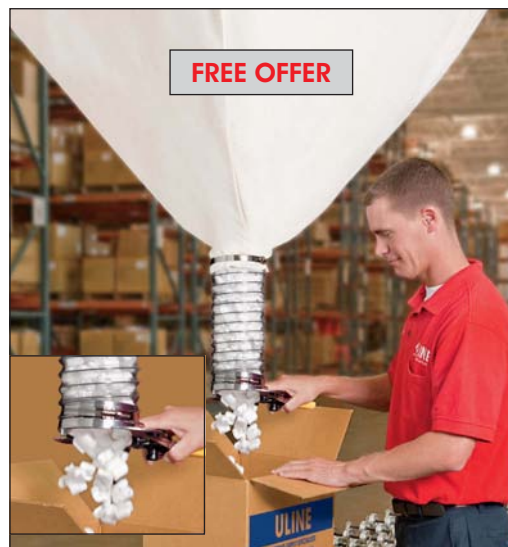

# PEANUT DISPENSERS

Release the right amount of peanuts every time you fill a carton.

- Squeeze the spring-loaded scissor valve to control flow of peanuts.
- Mounts to warehouse ceiling. Includes 13 ft. rope and 2 pulleys for height adjustment and refills.
- Heavy-duty, rot-proof canvas bag with reinforced flexible tubing.

MODEL NO.	BAG SIZE	BAG HEIGHT	WT. (LBS.)	PRICE EACH	
				1	2+
H-184	15 cu. ft.	3 ft.	10	\$201	\$195
H-185	20 cu. ft.	5 ft.	12	207	199
H-186	40 cu. ft.	7 ft.	13	233	225
H-196	60 cu. ft.	9 ft.	15	310	293
H-201	80 cu. ft.	11 ft.	25	365	347
H-202	Replacement 5" metal valve			\$130	

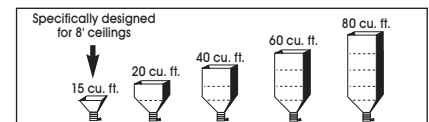

## FREE OFFER

Order our popular H-423 20 cu. ft. peanut dispenser. Receive 2 FREE bags of S-1128 UPSable peanuts.

MODEL NO.	DESCRIPTION	PRICE EACH
H-423	Dispenser and 2 free peanut bags	\$207



# BIODEGRADABLE PEANUTS

## STARCH

Uline's fastest growing peanut.

- Decomposes in water leaving no toxic waste. FDA compliant.
- Static-free organic starch.
- Dispenses and vacuums like traditional peanuts.



MODEL NO.	DESCRIPTION	BAG SIZE	PRICE EACH					
			1	3	6	12	20	40+
S-1564	Starch	12 cu. ft.	\$22 each any quantity					CALL FOR QUOTE
S-15245		20 cu. ft.	\$29 each any quantity					

SHIPS VIA MOTOR FREIGHT

# ULINE INDUSTRIAL PEANUTS

Uline's best-selling peanuts have the following advantages:

- **Void fill** – Surrounds entire product for total protection of your shipment.
- **Interlocking** – Peanuts interlock firmly and prevent "settling."
- **Lightweight** – Warehouse favorite for ease of use.
- **Low cost** – Ensures product and labor costs are kept to a minimum.



\* MEETS MIL SPEC. PPP-C-1683 \*\* MEETS MIL SPEC. MIL-B-81705E

MODEL NO.	DESCRIPTION	BAG SIZE	PRICE EACH					
			1	3	6	12	20	40+
S-258*	White Anti-Static	20 cu. ft.	\$33 each any quantity					CALL FOR QUOTE
S-525**	Pink Anti-Static		\$35 each any quantity					

SHIPS VIA MOTOR FREIGHT

# PAD LOC™ CUSHIONING PADS



Alternative to expensive custom packaging.

- Peanut-filled pads conform to the shape of your products.
- Reuse up to 20 times. No mess protection.
- Recommended for shipping scales, tape machines and large parts.

MODEL NO.	PAD SIZE	PADS/BAG	PRICE PER BAG		
			1	3	6+
S-17451	12 x 12 x 2"	200	\$144	\$136	\$131
S-17452	12 x 18 x 2"	90	96	92	87
S-17453	12 x 24 x 2"	60	84	81	77

SHIPS VIA MOTOR FREIGHT

# ULINE UPSABLE PEANUTS



S-1128 WHITE ANTI-STATIC



S-1129 PINK ANTI-STATIC



S-2322 STARCH

Perfect for low-volume packing or warehouses with limited storage space.

- Choose from 3 types of peanuts.



\* MEETS MIL SPEC. PPP-C-1683 \*\* MEETS MIL SPEC. MIL-B-81705E

MODEL NO.	DESCRIPTION	BAG SIZE	PRICE EACH				
			1	3	6	12	20+
S-1128*	White Anti-Static	7 cu. ft.	\$23	\$22	\$21	\$20	\$19
S-1129**	Pink Anti-Static		23	22	21	20	19
S-2322	Starch		\$19 each any quantity				

# KRAFT PAPER SHEETS

Use precut sheets for **uniform size items** or interleaving.

- 30, 40 and 50 lb. Kraft Paper Sheets are strong and durable, yet easy to handle. 100% recycled.

## 30 LB. BASIS WEIGHT

MODEL NO.	SIZE	SHEETS/BUNDLE	MODEL NO.	SIZE	SHEETS/BUNDLE	LBS./BUNDLE	PRICE PER BUNDLE		
							1	3	6+
S-19318	8½ x 11"	7,700	S-12830	24 x 36"	800	50	\$92	\$83	\$80
S-13732	18 x 18"	2,200	S-19319	36 x 36"	535				
S-12829	18 x 24"	1,600	S-14728	36 x 48"	400				

## 40 LB. BASIS WEIGHT

S-15800	18 x 24"	1,250	S-14729	24 x 36"	625	50	\$89	\$80	\$77
---------	----------	-------	---------	----------	-----	----	------	------	------

## 50 LB. BASIS WEIGHT

S-20062	8½ x 11"	4,600	S-6074	18 x 24"	1,000	50	\$86	\$79	\$75
S-19320	11 x 16"	2,450	S-1845	24 x 36"	500				
S-11421	12 x 12"	3,000	S-1846	30 x 40"	360				
S-11422	12 x 18"	2,000	S-3580	36 x 48"	230				
S-11423	15 x 20"	1,400	S-15801	40 x 48"	225				

■ SHIPS VIA MOTOR FREIGHT

# KRAFT PAPER SKID LOTS

SAVE UP TO 55%

Buy in full skids for significant savings.

- Low cost, all-purpose paper for cushioning and wrapping.
- 100% recycled.
- 8½" diameter roll.
- Ships via motor freight.

MODEL NO.	WIDTH	BASIS WEIGHT	LENGTH/ROLL	PRICE/ROLL	ROLLS/SKID	SKID LOTS
S-3575S	24"	30 lb.	1,200'	\$28	50	\$1,400
S-3579S	36"			41	25	1,025
S-2208S	24"	40 lb.	900'	24	50	1,200
S-2210S	36"			36	25	900



# PAPER CUTTERS



MULTI DECK  
H-413



HORIZONTAL  
H-3833



VERTICAL  
H-365

Cut industrial rolls of paper smoothly and cleanly.

- Versatile horizontal cutter can be used standing, mounted on walls or hanging under workspaces.
- H-3833, H-1244, H-1245 and H-1606 with serrated blade for cutting plastic film and foil.
- Made in the USA.

## HORIZONTAL

MODEL NO.	WIDTH	FOR USE WITH ROLL WIDTHS	WT. (LBS.)	PRICE EACH		
				1	3	6+
H-345	12"	12"	3	\$35	\$34	\$33
H-3832	15"	15"	3	39	37	35
H-193	18"	18"	4	42	40	37
H-194	24"	20, 24"	4	47	45	43
H-192	30"	30"	5	54	51	49
H-195	36"	36"	6	55	52	50
H-364	48"	40, 48"	10	104	101	97
H-1605	60"	60"	14	147	141	136

## HORIZONTAL WITH SERRATED BLADE

H-3833	18"	12, 15, 18"	4	\$58	\$56	\$54
H-1244	24"	20, 24"	4	73	70	66
H-1245	36"	30, 36"	6	86	82	80
H-1606	48"	40, 48"	10	112	109	106

## VERTICAL

MODEL NO.	WIDTH	FOR USE WITH ROLL WIDTHS	WT. (LBS.)	PRICE EACH		
				1	3	6+
H-365	27"	20, 24, 27"	11	\$207	\$201	\$195
H-248	36"	30, 36"	13	241	233	224
H-356	48"	40, 48"	15	284	276	268
H-249				Set of Casters for Vertical Cutters – \$69 per set		

## MULTI DECK

MODEL NO.	WIDTH	HOLDS	FOR USE WITH ROLL WIDTHS	WT. (LBS.)	PRICE EACH		
					1	3	6+
H-412	24"	2 Rolls	12, 18, 20, 24"	16	\$173	\$167	\$161
H-413	36"		30, 36"	21	190	183	177
H-2267	48"		40, 48"	27	270	259	247
H-1921	24"	3 Rolls	12, 18, 20, 24"	22	241	230	218
H-1922	36"		30, 36"	26	276	265	247
H-1923	24"	4 Rolls	12, 18, 20, 24"	23	339	328	311
H-1924	36"		30, 36"	28	368	351	328

# KRAFT PAPER ROLLS

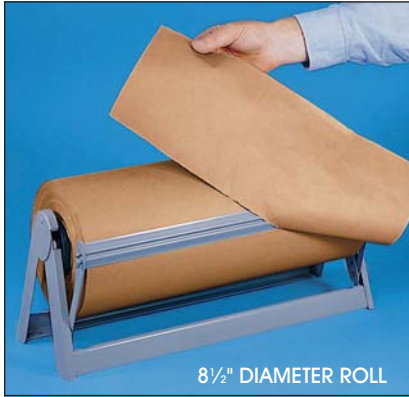

8 1/2" DIAMETER ROLL



## ROLLS

MODEL NO.	WIDTH	BASIS WEIGHT	LENGTH/ROLL	LBS./ROLL	PRICE PER ROLL					ROLLS/SKID	SKID LOTS		
					1	3	6	10	20+				
S-13805	6"	30 lb.	1,200'	6	\$16	\$15	\$14	\$13	\$12	125	\$875		
S-11416	9"			9	22	21	20	19	18	100	1,100		
S-8511	12"			12	27	26	25	24	22	75	1,050		
S-3574	18"			18	32	30	28	27	25	50	1,050		
S-3575	24"						\$34 per roll any quantity					50	1,400
S-3578	30"			30	49	46	45	44	42	25	875		
S-3579	36"						\$50 per roll any quantity					25	1,025
S-5156	40"			40	67	65	62	60	58	25	1,125		
S-5157	48"			48	80	77	72	70	67	25	1,375		
S-12821	60"			60	97	95	90	87	82	25	1,525		
S-2228	12"	40 lb.	900'	12	26	25	24	22	20	75	975		
S-11417	15"			15	27	26	25	24	21	50	800		
S-2207	18"			18	30	28	27	26	24	50	900		
S-2696	20"			20	34	33	32	28	26	50	1,050		
S-2208	24"						\$33 per roll any quantity					50	1,200
S-2209	30"			30	47	45	44	43	40	25	750		
S-2210	36"						\$50 per roll any quantity					25	900
S-2697	40"			40	65	62	60	58	56	25	1,025		
S-2211	48"			48	78	74	70	67	65	25	1,225		
S-11418	60"			60	95	92	87	85	79	25	1,525		
■ S-13806	72"	72	116	109	106	103	97	25	1,750				
S-2229	12"	50 lb.	720'	12	25	24	22	21	19	75	900		
S-1911	18"			18	28	27	26	25	22	50	850		
S-2698	20"			20	33	32	30	28	26	50	1,000		
S-1311	24"			24	37	36	35	34	32	50	1,150		
S-1912	30"			30	46	44	43	42	39	25	725		
S-1312	36"			36	57	55	50	47	45	25	850		
S-2699	40"			40	62	60	58	56	54	25	1,000		
S-1841	48"			48	75	71	67	65	62	25	1,200		
S-6073	60"			60	92	90	85	82	77	25	1,500		
S-8512	18"			60 lb.	600'	18	27	26	25	24	23	50	900
S-5328	24"	24	35			34	33	32	31	50	1,200		
S-8513	30"	30	45			43	42	40	39	25	750		
S-5329	36"	36	60			58	56	54	49	25	900		
S-5330	48"	48	72			70	67	65	62	25	1,200		
S-11419	60"	60	90			87	82	79	75	25	1,500		
S-7051	24"	75 lb.	475'			24	33	32	31	30	29	50	1,150
S-7052	36"			36	60	58	56	54	49	25	850		
S-7053	48"			48	72	70	67	65	62	25	1,125		
S-11420	60"			60	90	87	82	79	74	25	1,400		

■ SHIPS VIA MOTOR FREIGHT

A low cost, all-purpose packaging material.

**CUSHIONING:** Use as an economical void fill for shipping.

**WRAPPING:** Cover boxes, books and parts to protect against scratches.

100% recycled.

- Custom sizes and weights available. Call for quote.

### SKID LOT SPECIAL



**SAVE UP TO 55% ON SKID QUANTITIES**

### SHIPPING SAVINGS

Ships from Chicago, Atlanta, Dallas, Los Angeles, Miami, Minneapolis, NYC/Phila, Reno or Seattle.



## POLY COATED KRAFT PAPER



Extra protection from grease, oil and water.

- Recommended for protecting metal parts and tools.
- 50 lb. virgin kraft paper coated with 10 lb. gloss poly on one side.
- Poly coating provides added tear strength.

### ROLLS

MODEL NO.	WIDTH	LENGTH/ROLL	BASIS WEIGHT	LBS./ROLL	PRICE PER ROLL		
					1	3	6+
S-11455	12"	600'	50 lb.	13	\$37	\$35	\$33
S-5226	18"			19	55	52	50
S-6226	24"			25	70	68	66
S-5227	36"			37	107	103	98
S-5228	48"			48	140	133	127
S-14612	60"			62	170	163	155

### SHEETS

MODEL NO.	DIM. W x L	SHEETS/BUNDLE	BASIS WEIGHT	LBS./BUNDLE	PRICE PER BUNDLE		
					1	3	6+
S-11456	18 x 24"	820	50 lb.	53	\$145	\$138	\$130
S-11457	24 x 36"	410		51			

## WAXED PAPER



Protect products from water, grease and oil.

- Recommended for surface protection, interleaving, and preserving products.
- 30 lb. kraft paper waxed on both sides to 43 lbs.
- Lightweight, nonabrasive paper.

### ROLLS

MODEL NO.	WIDTH	LENGTH/ROLL	BASIS WEIGHT	LBS./ROLL	PRICE PER ROLL		
					1	3	6+
S-19573	12"	1,500'	30 lb.	24	\$73	\$70	\$66
S-7048	18"			35	109	104	98
S-7049	24"			47	143	136	130
■ S-7050	36"			72	215	205	196
■ S-11462	48"			96	289	275	261
■ S-12820	60"			120	358	339	322

■ SHIPS VIA MOTOR FREIGHT

### SHEETS

MODEL NO.	DIM. W x L	SHEETS/BUNDLE	BASIS WEIGHT	LBS./BUNDLE	PRICE PER BUNDLE		
					1	3	6+
S-11463	12 x 12"	3,400	30 lb.	52	\$204	\$195	\$185
S-11464	24 x 36"	560					



## REINFORCED KRAFT PAPER

Wrap and protect sharp, heavy tools or steel parts and components.

- Provides a protective barrier against moisture, grease and oil.
- White poly reinforced scrim exterior.
- Tear and puncture resistant.

MODEL NO.	WIDTH	LENGTH/ROLL	BASIS WEIGHT	LBS./ROLL	PRICE PER ROLL		
					1	3	6+
S-20031	36"	300'	50 lb.	20	\$90	\$84	\$78
S-20032	48"			27	125	117	109

## VIRGIN KRAFT PAPER



Virgin fiber provides a stiffer paper with superior tear resistance.

- Recommended for wrapping office equipment, rugs and industrial parts.

FDA COMPLIANT

MODEL NO.	WIDTH	LENGTH/ROLL	BASIS WEIGHT	LBS./ROLL	PRICE PER ROLL		
					1	3	6+
S-20804	24"	1,200'	30 lb.	24	\$38	\$36	\$35
S-20805	36"			36	57	55	53
S-20806	24"	900'	40 lb.	24	37	35	34
S-20807	36"			36	56	54	52

## FLAME RETARDANT PAPER



Temporary protection against sparks during welding and grinding.

- Heavy-duty paper will not ignite.
- OSHA compliant.

- Stands up to foot traffic and abuse.

MODEL NO.	WIDTH	LENGTH/ROLL	BASIS WEIGHT	LBS./ROLL	PRICE PER ROLL		
					1	3	6+
S-22458	36"	300'	80 lb.	24	\$99	\$93	\$87
S-22459	72"			48	187	175	163

# BUTCHER PAPER

Cover tables or wrap deli items.

- 40 lb. virgin paper. • FDA compliant.
- Low sulfur. Near neutral pH.

**White** – Use smooth white kraft paper for a cleaner presentation.

**Unbleached** – Natural kraft color for wrapping steaks and chops.



## WHITE SHEETS

MODEL NO.	DIM. W x L	SHEETS/BUNDLE	BASIS WEIGHT	PRICE PER BUNDLE		
				1	3	6+
S-15674	12 x 12"	3,750				
S-21316	18 x 18"	1,667				
S-15675	18 x 24"	1,250				
S-19326	24 x 30"	750	40 lb.	\$95	\$90	\$85
S-21317	30 x 30"	600				
S-21318	30 x 48"	375				
S-15676	36 x 36"	415				

## UNBLEACHED ROLLS

MODEL NO.	WIDTH	LENGTH/ROLL	BASIS WEIGHT	PRICE PER ROLL		
				1	3	6+
S-20818	18"			\$42	\$39	\$36
S-20819	24"	1,100'	40 lb.	55	51	47
S-20820	36"			81	75	69

## WHITE ROLLS

MODEL NO.	WIDTH	LENGTH/ROLL	BASIS WEIGHT	PRICE PER ROLL		
				1	3	6+
S-11458	12"			\$30	\$28	\$26
S-11459	15"			36	34	32
S-5231	18"			43	40	37
S-5232	24"			57	53	50
S-11460	30"	1,100'	40 lb.	70	66	62
S-5233	36"			85	78	73
S-6077	48"			111	103	96
S-11461	60"			136	127	118
S-19691	72"			165	154	143

# FREEZER PAPER

## WHITE ROLLS

MODEL NO.	WIDTH	LENGTH/ROLL	BASIS WEIGHT	PRICE PER ROLL		
				1	3	6+
S-7045	15"			\$57	\$54	\$51
S-7046	18"			69	65	60
S-7047	24"	1,100'	40 lb.	93	86	80
S-15677	30"			113	105	97
S-11465	36"			137	127	118
S-15678	48"			180	167	154

## WHITE SHEETS

MODEL NO.	DIM. W x L	SHEETS/BUNDLE	BASIS WEIGHT	PRICE PER BUNDLE		
				1	3	6+
S-11466	12 x 15"	2,600	40 lb.	\$178	\$166	\$157
S-11467	15 x 15"	2,100				

Protect food products for up to 1 year.

- 40 lb. virgin paper bleached white and coated with 5 lb. polyethylene on one side.
- Stays strong, even when wet.
- FDA compliant.



# STAINLESS STEEL PAPER CUTTERS

Use in exclusive butcher shops, delis and fancy restaurants.

- Cut freezer paper and foil smoothly and cleanly.
- Mount easily to wall or work surface.



MODEL NO.	WIDTH	FOR USE WITH ROLL WIDTHS	WT. (LBS.)	PRICE EACH		
				1	3	6+
H-7256	18"	12, 15, 18"	4	\$103	\$101	\$97
H-7257	24"	24"	5	123	118	114
H-7258	36"	30, 36"	6	163	158	152

# MARTOR® SAFETY KNIFE

The ultimate safety knife.

- German technology with smooth cam action.
- Easy-squeeze trigger activates blade.
- Aluminum body with rubber comfort grip.



Includes 1 blade

MODEL NO.	DESCRIPTION	PRICE EACH			H-7255B BLADES
		1	5	10+	
H-7255	Secupro 625™	\$45	\$43	\$41	\$9 10/pk.

# COLOR KRAFT PAPER



**BLACK** – Widely used for backing pictures and artwork. Smooth on both sides.

**COLORED** – Use for bulletin boards, banners, table coverings and craft projects. Smooth surface on one side, textured on the other.

- Use with paints, markers and chalk.

\* SPECIFY COLOR:  Red  Yellow  Blue

MODEL NO.	COLOR	WIDTH	LENGTH/ROLL	BASIS WEIGHT	PRICE PER ROLL		
					1	3	6+
S-23544		18"			\$61	\$58	\$55
S-11425	Black	24"	720'	50 lb.	81	78	75
S-11426		36"			120	115	110
S-13633		48"			160	155	150
S-11427*	Specify	36"	1,000'	50 lb.	160	155	150

# TYVEK® ROLLS



Protective lining for artwork, textiles and fragile valuables.

- Use for shipping or long-term storage.
- Resistant to mold, mildew, water and dust particles.
- Tear-resistant, nonabrasive spunbonded olefin.

MODEL NO.	DESC.	WIDTH	LENGTH/ROLL	MIL	PRICE PER ROLL		
					1	3	5+
S-10680	Tyvek®	24"	150'	7.5	\$129	\$124	\$114
S-10681		30"			157	149	137
S-19917		36"			191	181	168
S-13634		48"			256	242	225
S-15688		60"			313	298	272

# BOGUS PAPER



An economical choice for multipurpose void fill.

- Wrap books, plates or knickknacks.
- Thick, absorbent paper provides protection.

MODEL NO.	DESC.	WIDTH	LENGTH/ROLL	BASIS WEIGHT	PRICE PER ROLL		
					1	3	6+
S-15804	Bogus	24"	1,200'	30 lb.	\$40	\$37	\$36
S-15805		36"			59	56	53
S-12831	Bogus	12"	720'	50 lb.	19	18	17
S-11424		18"			27	26	25
<b>S-8514</b>		<b>24"</b>			<b>\$35 per roll any quantity</b>		
S-12832		30"			46	43	41
S-8515		36"			55	53	51
S-12833		48"			76	72	68



# ADHESIVE FOAM ROLLS

Provides total surface protection of odd-shaped objects.

- 1/16" adhesive foam sticks tight to product. Peels off cleanly.
- Saves time – no need for tape.
- Superior puncture strength.

**PERFORATED ROLLS** – Cross perforated every 12 inches.

MODEL NO.	THICKNESS	ROLL SIZE	LBS./ROLL	PRICE PER ROLL		
				1	3	6+
S-23545	1/16"	12" x 250'	5	\$85	\$80	\$75
S-23546		24" x 250'	10	150	140	130



# NEWSPRINT

30 LB. GRADE "A"

A clean **low-cost alternative for void fill**, wrapping lightweight items or using as interleaving.

**SHEETS** Newsprint sheets are securely packaged in boxes.

MODEL NO.	SHEET SIZE	BASIS WEIGHT	SHEETS/BUNDLE	LBS./BN DL.	PRICE PER BUNDLE		
					1	5	10+
S-14640	20 x 30"	30 lb.	600	25	\$41	\$40	\$38
S-13759	24 x 36"		400				
S-19325	11 x 17"		3,800	50			
S-15706	12 x 18"		3,300				
S-6070	15 x 20"		2,400				
S-2460	18 x 24"		1,666				
S-639	20 x 30"		1,200				
S-2461	24 x 30"		1,000				
S-638	24 x 36"		800				
S-3971	36 x 48"		415				
S-15707	24 x 36"	50 lb.	500	50	85	82	78

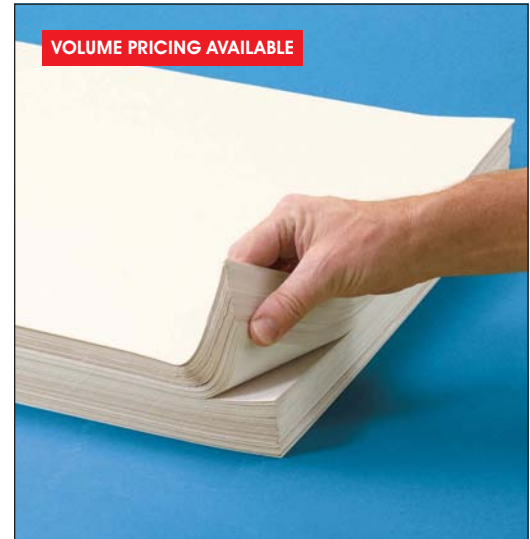

## SKID LOT SHEETS

MODEL NO.	SHEET SIZE	BASIS WEIGHT	SHEETS/BUNDLE	BN DL S./SKID	SKID PRICE PER BUNDLE
S-6070S	15 x 20"	30 lb.	2,400	30	<b>\$42</b> <b>REDUCED PRICING</b>
S-2460S	18 x 24"		1,666	32	
S-639S	20 x 30"		1,200	30	
S-2461S	24 x 30"		1,000	26	
S-638S	24 x 36"		800	30	
S-3971S	36 x 48"		415	28	



SAVE UP TO 25%



## NEWSPRINT ROLLS 9" diameter rolls.

MODEL NO.	WIDTH	BASIS WEIGHT	LENGTH/ROLL	LBS./ROLL	PRICE PER ROLL			
					1	3	5	10+
S-2462	12"	30 lb.	1,695'	16	\$28	\$27	\$26	\$25
S-12817	15"			20	34	32	31	29
S-2463	18"			24	39	37	35	32
S-3972	20"			26	42	40	38	36
S-1078	24"			32	<b>\$35 per roll any quantity</b>			
S-2464	30"			40	62	60	57	55
S-1079	36"			48	74	70	67	64
S-2943	48"			64	87	82	78	74



# TISSUE PAPER

Soft and manageable. Crumples easily for packing in cartons and mailers.

- Cushions breakables, glassware and china.
- Cost-effective wrap, void fill and interleave.

\* 14 assorted bright and pastel colors, including White.

Individual colors sold separately. See page 183.

MODEL NO.	DESC.	BASIS WEIGHT	COLOR	SHEET SIZE	SHEETS/CTN.	LBS./CTN.	PRICE/CTN.	
							1	3+
S-24889	Industrial	22 lb.	Ecru	15 x 20"	3,900	60	\$98	\$94
S-24890				20 x 30"	1,900			
S-24891				24 x 36"	1,300			
■ S-2227	Gift Grade	10 lb.	White	20 x 30"	4,800	75	185	175
S-6072*			Assorted	20 x 30"	480	8	49	47

■ SHIPS VIA MOTOR FREIGHT





## RAM BOARD®

Cover surfaces during home remodeling and commercial construction projects.

- Thick, durable paperboard protects floors from water, scratches and stains.
- Stands up to scaffolding and heavy equipment.
- Rolls out fast and flat.

**Pressure Sensitive Kraft Tape –**  
Tapes seams together.

### RAM BOARD®

MODEL NO.	WIDTH	LENGTH/ROLL	THICKNESS (MIL)	LBS./ROLL	PRICE PER ROLL		
					1	3	6+
S-21372	38"	100'	46	39	\$83	\$79	\$75
■S-22488	48"			49	118	112	107

■ SHIPS VIA MOTOR FREIGHT

### ULINE PRESSURE SENSITIVE KRAFT TAPE

MODEL NO.	SIZE	TENSILE STRENGTH	ROLLS/CASE	LBS./CASE	PRICE PER ROLL (MIN. 12)		
					12	24	96+
S-2492	3" x 60 yds.	42 lbs.	16	24	\$13.35	\$12.80	\$11.75



## RAM BOARD® PLUS

No need for tape. Peel-and-stick adhesive strip reduces installation time by 40%.

- Recommended for renovation, home improvement and new construction.
- Durable paperboard rolls out flat. Overlapping seams seal out water, paint and mud.

MODEL NO.	WIDTH	LENGTH/ROLL	THICKNESS (MIL)	LBS./ROLL	PRICE PER ROLL		
					1	3	6+
S-22940	38"	100'	46	48	\$97	\$93	\$89

## HARDBOARD SHEETS



Heavy duty. Protect your floors during construction or while moving with heavy equipment.

- Prevent scratches and impact damage on marble, tile, vinyl, carpet and wood floors.
- Resists water, warping and buckling. Formaldehyde free.
- Smooth finish on one side, textured on the other.
- Transport and store on Panel Trucks, see page 443.

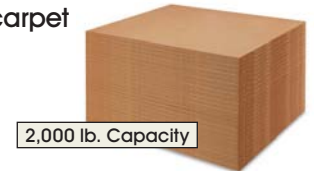

MODEL NO.	SIZE W x L	THICKNESS	LBS./BOARD	PRICE EACH (MIN. 10)			BOARDS/SKID	SKID LOT
				10	30	50+		
S-23686	48 x 48"	1/8"	11	\$11	\$10	\$8	200	\$1,300

SHIPS VIA MOTOR FREIGHT

## RED ROSIN PAPER

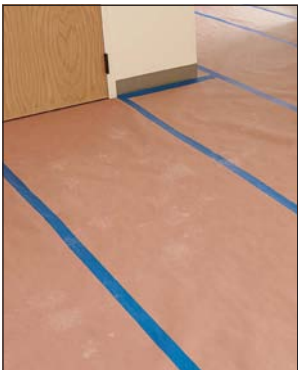

Temporary protection during painting, tilework and lightweight projects.

- Heavy, non-adhesive paper is tear and water resistant.
- Quick, easy cleanup.
- Use S-9759 Uline Painter's Tape for large areas.

MODEL NO.	WIDTH	LENGTH/ROLL	BASIS WEIGHT	LBS./ROLL	PRICE PER ROLL		
					1	3	6+
S-20035	36"	520'	70 lb.	36	\$49	\$47	\$45
S-9759	Uline Painter's Tape – 2" x 60 yds.				12/\$9.95 ea.	24+/\$7.95 ea.	

## PLEXIGLAS® SHEETS



Create signs, frame pictures or fabricate machine guards.

- Half the weight of glass with superior impact resistance.
- Weather and UV resistant. Excellent for outdoor use.
- Rigid, crystal clear sheets won't warp or yellow.
- Cut to size with saw or router.

SOLD IN CARTON QUANTITIES

MODEL NO.	SIZE W x L	THICKNESS	SHEETS/CTN.	LBS./CTN.	PRICE PER SHEET		
					5	10	20+
S-22486	24 x 48"	1/8"	5	30	\$47	\$45	\$43
■S-22487	48 x 48"				86	83	80

■ SHIPS VIA MOTOR FREIGHT

# INDENTED KRAFT PAPER

## ROLLS

MODEL NO.	WIDTH	LENGTH/ROLL	BASIS WEIGHT	LBS./ROLL	PRICE PER ROLL		
					1	3	6+
S-6227	18"	360'	60 lb.	11	\$23	\$22	\$21
S-3652	24"			15	29	28	27
S-3653	36"			26	44	43	41
S-3654	48"			38	58	56	53

## SHEETS

MODEL NO.	DIM. W x L	SHEETS/BUNDLE	BASIS WEIGHT	LBS./BUNDLE	PRICE PER BUNDLE		
					1	3	6+
S-7074	18 x 24"	400	60 lb.	25	\$65	\$61	\$59
S-7075	24 x 36"	200					

Heavy-duty, non-abrasive protection for fragile items or industrial parts.

- Crumples easily to fill any space.
- Indented texture creates a no-slide surface.
- 80% virgin material.



ROLLS



SHEETS

# PLOTTER PAPER

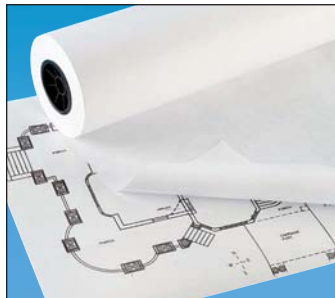

Print crisp, clear CAD drawings, blueprints and landscaping plans.

- 92 bright bond paper. Dust-free surface.
- 20 lb. bond basis weight.
- Acid free. Won't yellow or fade over time.
- Fits most wide-format inkjet printers and engineering copiers.

MODEL NO.	WIDTH	LENGTH/ROLL	CORE SIZE	ROLLS/CTN.	LBS./CTN.	PRICE PER CARTON		
						1	3	6+
S-19926	24"	150'	2"	4	20	\$58	\$55	\$51
S-19927		500'	3"	2	31	72	68	64
S-19928	36"	150'	2"	4	28	88	84	79
S-19929		500'	3"	2	46	101	97	92

# CUSHION WRAP

Cushioned protection for products with sharp edges.

- 5-layered indented kraft won't tear or puncture.
- Embossed kraft paper is soft and nonabrasive.
- Perforated every 15" for easy tearing.



MODEL NO.	ROLL SIZE	THICKNESS	LBS./ROLL	PRICE PER ROLL			
				1	4	6+	
S-1556	12" x 250'	1/4"	5 Ply	16	\$46	\$44	\$42
S-1557	24" x 250'			31	91	87	83

# SOUNDPROOFING FOAM

Shhh! Dampen sound in printing rooms, warehouses and noisy environments.

- Staple, glue or tack to walls and ceiling for optimum noise cancellation.
- Gray, convoluted foam absorbs 95% of high frequency sounds.

SOLD IN CARTON QUANTITIES

MODEL NO.	SHEET SIZE L x W x H	TYPE OF FOAM	SETS/CTN.	LBS./CTN.	PRICE PER SET	
					1 CTN.	3+ CTNS.
S-22484	27 x 54 x 3"	Sound-proof	5	27	\$102	\$98
S-22485	54 x 54 x 3"				53	175

SHIPS VIA MOTOR FREIGHT

- Meets UL94HF-1 flammability requirements.

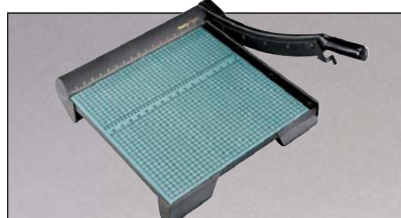

# PAPER TRIMMERS

Cuts paper, matboard and cardboard.

- Self-sharpening steel blade.
- Safety guard protects fingers.
- Cuts up to 15 sheets at a time.

MODEL NO.	CUTTING LENGTH	BOARD DIMENSIONS	PRICE EACH	
			1	3+
H-2247	12"	12 x 12"	\$125	\$115
H-2248	18"	18 x 18"	215	200
H-2516	24"	18 x 24"	290	275





**KRAFT**

## VERSA-PAK™ (FORMERLY KIMPAK®)

### KRAFT

"Super Crepe" easily conforms to any shape product.

- Perforated at 12" with **additional vertical 6" zip**.
- Oil and water absorbent.
- Soft, nonabrasive.
- UPSable bundles.
- 100% recycled and reusable.

### WHITE

Clean appearance is ideal for medical supplies, art objects and packaged foods.

- 100% recycled and reusable.
- Perforated every 12".

### EXPANDABLE

Unique expandable strips provide the same protection as traditional rolls.

- Crepe sections are compressed 80% – Ideal for limited workspaces.
- Expands up to five times the original size.
- Oil and water absorbent.



**WHITE**



**EXPANDABLE**

SHIPS VIA MOTOR FREIGHT

MODEL NO.	DESCRIPTION	THICKNESS	ROLL SIZE W x L	RLS./BNDL.	LBS./ROLL	PRICE PER ROLL (SOLD IN BUNDLES)			
						2	4	8	16+
S-2146	Kraft	1/4"	12" x 200'	4	9	N/A	\$42	\$41	\$40
S-2147			24" x 200'	2	18	\$87	85	82	80
S-3576	Kraft	1/2"	12" x 120'	4	13	N/A	46	44	43
S-3577			24" x 120'	2	26	96	94	89	87
S-2694	White	1/4"	12" x 200'	4	9	N/A	54	50	49
S-2695			24" x 200'	2	18	107	105	102	99

MEETS MIL. SPEC. A-A-1898B/C

MODEL NO.	DESCRIPTION	THICKNESS	TOTAL SQ. FT.	ROLL SIZE W x L	RLS./CASE	LBS./CASE	PRICE PER CASE		
							1	4	6+
S-6075	Expandable	3/4"	334	12" x 167'	2	19	\$148	\$144	\$140
S-6076				24" x 167'	1				

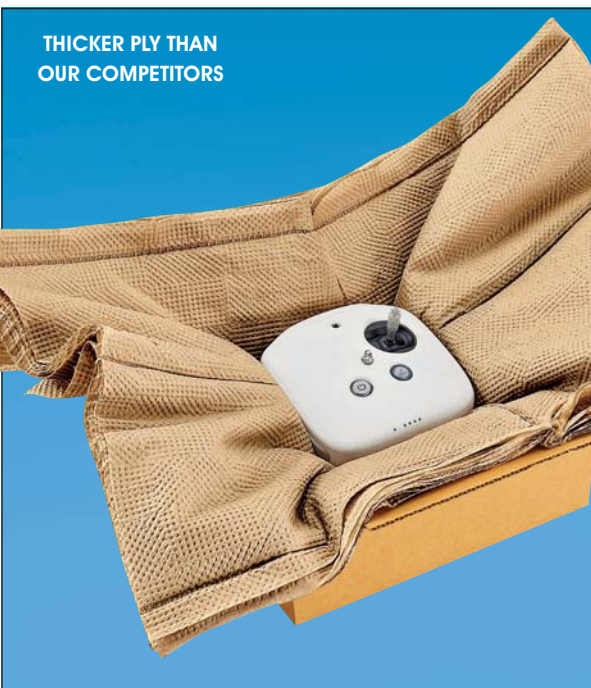

**THICKER PLY THAN OUR COMPETITORS**

## CUSTOM WRAP™

**100% recycled, recyclable, reusable.**

- Multilayer tissue provides excellent cushioning or void fill.
- Soft – Conforms to any shape.
- Nonabrasive surface protection.
- Absorbent – Easily absorbs oil and liquid spills during shipment.



Perforated every 15", middle zip for easy cross tearing.

SHIPS VIA MOTOR FREIGHT

MODEL NO.	THICKNESS	ROLL SIZE W x L	RLS./BNDL.	LBS./ROLL	PRICE PER ROLL (SOLD IN BUNDLES)				
					2	4	8	16+	
S-3969	1/8"	6 ply	12" x 200'	4	6	N/A	\$33	\$31	\$30
S-3970			24" x 200'	2	12	\$67	65	63	60
■S-666	1/4"	10 ply	12" x 200'	4	11	N/A	44	42	41
■S-667			24" x 200'	2	22	91	89	86	83
■S-610	1/2"	18 ply	20" x 100'	2	16	73	70	66	65

# CORRUGATED WRAP

## KRAFT – A Flute

MODEL NO.	ROLL SIZE W x L	LBS./ ROLL	PRICE PER ROLL			
			1	3	6	10+
S-11450	3" x 250'	4	N/A	N/A	\$8.40	\$7.80
S-13760	4" x 250'	5	N/A	N/A	10.00	9.10
S-1673	6" x 250'	7	N/A	N/A	12.70	11.60
S-2714	9" x 250'	11	N/A	\$18.00	17.00	16.00
S-413	12" x 250'	14	N/A	23.00	22.00	21.00
S-2715	15" x 250'	18	\$30.00	28.00	27.00	25.00
S-414	18" x 250'	22	35.00	34.00	33.00	31.00
S-415	24" x 250'	29	46.00	43.00	42.00	41.00
■S-2716	30" x 250'	36	55.00	52.00	51.00	50.00
■S-416	36" x 250'	43	\$60 per roll any quantity			
■S-1242	48" x 250'	58	\$86 per roll any quantity			
■S-1477	60" x 250'	72	115.00	110.00	105.00	100.00
■S-1478	72" x 250'	86	135.00	130.00	125.00	120.00

■ SHIPS VIA MOTOR FREIGHT

## KRAFT – B Flute

S-19397	24" x 250'	29	\$46.00	\$43.00	\$42.00	\$41.00
S-19398	36" x 250'	43	68.00	66.00	64.00	62.00
■S-19399	48" x 250'	58	94.00	90.00	88.00	86.00

■ SHIPS VIA MOTOR FREIGHT



### CORRUGATED WRAP DISPENSER

Store, move and dispense Corrugated Wrap easily, see [uline.com](http://uline.com)



Roll out the single-face corrugated and wrap up breakables.

- Protects glass products, metal parts, china, etc., from scratches, chips or breaks.
- Conforms to any shape. Flexible and shock absorbing.
- **A Flute** – Raised 1/4" fluting provides extra cushioning and strength.
- **B Flute** – Raised 1/8" fluting for easier wrapping and higher crush resistance.
- Min. order: 6 rolls of 3", 4" or 6"; 3 rolls of 9" or 12".

# COHESIVE CORRUGATED WRAP

Wrap and seal non-fragile items quickly.

- Single-face wrap is coated with cold seal adhesive, so corrugated sticks to itself, not to your product.

MODEL NO.	ROLL SIZE W x L	LBS./ ROLL	PRICE PER ROLL		
			1	3	6+
S-11453	12" x 250'	11	\$57	\$54	\$50
S-11454	18" x 250'	15	83	78	73
S-13761	24" x 250'	22	127	119	112
S-618	30" x 50'	9	37	35	34



Position product.



Wrap and press to seal.

# ULINE CELLULOSE WADDING

## SOFT CUSHIONING

Multilayer tissue provides excellent cushioning.

- Soft, nonabrasive and absorbent.
- Perforated every 15".

MODEL NO.	ROLL SIZE W x L	THICKNESS	LBS./ BOX	PRICE PER BOX			
				1	3	5+	
S-656	12" x 175'	1/4"	10 ply	11	\$50	\$48	\$46



# GATORFOAM® BOARD



The choice for mounting exhibits and signs where light weight, rigidity and warp resistance are a must.

- Dense polystyrene foam core has solid wood-fiber veneer for added strength.
- Paintable, direct digital print, direct screenprint surface.
- Strongest foamboard available.
- Cut to size with a knife, saw or router.

## WHITE

MODEL NO.	SIZE W x L	THICKNESS	SHEETS/CTN.	PRICE PER SHEET			LBS./CTN.
				1 CTN.	2 CTNS.	4+ CTNS.	
S-13738	32 x 40"	3/16"	5	\$28	\$27	\$26	11
■S-13739	48 x 96"		3	73	71	69	23
S-19924	32 x 40"	1/2"	3	43	42	39	8
■S-19305	48 x 96"		3	116	112	108	28
■S-19925	48 x 96"	1"	2	151	147	143	25

## SOLD IN CARTON QUANTITIES

## BLACK

S-13740	32 x 40"	3/16"	5	\$29	\$28	\$27	11
■S-13741	48 x 96"		3	77	73	71	23
■S-19306	48 x 96"	1/2"	3	119	116	112	28

■ SHIPS VIA MOTOR FREIGHT



## HIGH-TACK ADHESIVE FOAM CORE BOARD

Create permanent warehouse and retail signs without messy glues or sprays.

- High-tack, peel-'n-stick adhesive forms immediate bond for maximum hold.
- Easy to cut, mount and hang.
- Resists warping.

## SOLD IN CARTON QUANTITIES

MODEL NO.	SIZE W x L	THICKNESS	SHEETS/CTN.	PRICE PER SHEET			LBS./CTN.
				1 CTN.	2 CTNS.	4+ CTNS.	
S-22425	24 x 36"	3/16"	25	\$13	\$12	\$11	23
S-22426	32 x 40"		25	18	17	16	35



## GLASSINE PAPER

Protects documents, original drawings, photographs and negatives.

- Acid-free barrier. Can be creased, folded and written on.
- Resists grease and moisture.
- Archival Film, see uline.com

## ROLLS

MODEL NO.	WIDTH	LENGTH/ROLL	BASIS WEIGHT	PRICE PER ROLL		
				1	3	5+
S-14605	24"	300'	25 lb.	\$45	\$43	\$40
S-12941	36"			70	67	63
S-12942	48"			80	77	73
S-15687	60"			117	111	105

## SHEETS

MODEL NO.	SIZE W x L	SHEETS/BUNDLE	BASIS WEIGHT	PRICE PER BUNDLE		
				1	3	5+
S-19307	12 x 12"	500	25 lb.	\$25	\$24	\$23
S-19308	24 x 36"			142	135	128
S-19309	32 x 40"			210	200	190



## ACID-FREE TISSUE PAPER

Museum-quality protection. Wrap, cushion and preserve wedding dresses, leather gloves and valuable heirlooms.

- Unbuffered, pH neutral tissue is sulfur and lignin-free for long-term storage.
- Lightweight and easy to crumple.
- Soft finish eliminates scuffs and scratches.

MODEL NO.	SHEET SIZE	SHEETS/BUNDLE	BASIS WEIGHT	PRICE PER BUNDLE	
				1	3+
S-23029	15 x 20"	100	10 lb.	\$25	\$23
S-23030	20 x 30"			35	32
S-23031	24 x 36"			55	50



# ULINE FOAM CORE BOARD

## WHITE

SOLD IN CARTON QUANTITIES

MODEL NO.	SIZE W x L	THICKNESS	SHEETS/CTN.	PRICE PER SHEET			LBS./CTN.
				1 CTN.	2 CTNS.	4+ CTNS.	
S-14738	32 x 40"	1/8"	25	\$6.25	\$5.70	\$5.25	25
S-14739	8½ x 11"	3/16"	25	.90	.75	.70	3
S-19377	11 x 17"		25	1.55	1.40	1.25	5
S-13720	16 x 20"		25	2.55	2.45	2.15	9
S-19378	18 x 24"		25	2.80	2.70	2.45	11
S-12857	20 x 30"		25	3.00	2.80	2.55	16
S-11752	24 x 36"		25	4.20	3.80	3.50	23
S-14741	30 x 40"		25	5.85	5.35	4.85	33
S-17711	30 x 42"		25	6.25	5.70	5.25	34
S-11753	32 x 40"		25	6.25	5.70	5.25	35
■S-15813	36 x 48"		25	8.50	7.80	7.05	47
■S-11754	40 x 60"	25	11.70	10.80	9.85	65	
■S-23024	48 x 72"	25	17.80	16.10	14.30	89	
■S-11755	48 x 96"	25	18.95	17.40	15.80	125	
■S-13721	40 x 60"	1/2"	10	21.50	19.70	17.95	41
■S-13722	48 x 96"		10	40.60	37.30	33.85	84

## BLACK

S-19379	16 x 20"	3/16"	25	\$3.20	\$3.00	\$2.75	9	
S-13723	20 x 30"		25	3.80	3.55	3.20	16	
S-12858	24 x 36"		25	5.25	4.80	4.35	23	
S-19380	30 x 40"		25	7.30	6.65	6.15	33	
S-12859	32 x 40"		25	7.80	7.15	6.50	35	
■S-19381	36 x 48"		25	10.70	9.70	8.85	47	
■S-12860	40 x 60"		25	14.65	13.50	12.20	65	
■S-12861	48 x 96"		25	23.75	21.75	19.75	125	
■S-13724	48 x 96"		1/2"	10	55.35	50.70	46.10	84

## BLACK/WHITE

■S-19382	48 x 96"	3/16"	25	\$27.40	\$25.10	\$22.80	125
----------	----------	-------	----	---------	---------	---------	-----

## WHITE REPOSITIONABLE FOAM CORE

S-15814	8½ x 11"	3/16"	25	\$2.15	\$2.00	\$1.80	3
S-23025	11 x 17"		25	4.75	4.50	4.00	6
S-14742	16 x 20"		25	6.65	6.05	5.50	9
S-14743	20 x 30"		25	7.80	7.15	6.45	16
S-13725	24 x 36"		25	10.80	9.95	9.05	23
S-15815	30 x 40"		25	15.15	13.85	12.55	33
S-13726	32 x 40"		25	16.10	14.70	13.45	35
■S-15816	40 x 60"		25	30.05	27.60	25.15	65
■S-14744	48 x 96"		25	48.85	44.85	40.70	125

## BLACK REPOSITIONABLE FOAM CORE

S-14745	24 x 36"	3/16"	25	\$13.60	\$12.45	\$11.35	23
S-15817	32 x 40"		25	20.10	18.35	16.80	35

## HEAT ACTIVATED

S-19383	24 x 36"	3/16"	25	\$7.75	\$7.10	\$6.45	23
S-19384	32 x 40"		25	11.00	10.10	9.25	35

## WHITE ACID-FREE

S-15218	24 x 36"	3/16"	25	\$5.40	\$4.80	\$4.25	23
S-15219	32 x 40"		25	8.05	7.10	6.25	35

■ SHIPS VIA MOTOR FREIGHT



Mount pictures, posters or presentations.

- Stiff 1/8", 3/16" or 1/2" thick clay-coated foamboard.
- Lightweight, yet strong. Cuts easily.
- Smooth surface resists warping.

S-19382 – One side black, one side white.

## REPOSITIONABLE ADHESIVE FOAM CORE

Cold mount artwork with easy peel-'n-stick adhesive.

- Initially repositionable with low-tack adhesive.
- Resists warping.



## HEAT ACTIVATED

Create professionally mounted posters with vacuum press or laminator.

- Tack free until heat is applied.
- Reusable release liners included.

## WHITE ACID-FREE

Protects and preserves artwork, photographs, certificates, maps and documents.

- Core is laminated with two sheets of acid-free barrier paper.
- Will not become weak, brittle or yellow with age. pH neutral.

# DESICCANT BAGS



S-5168

**TYVEK® BAG**



S-14045



# CONTAINER DRI® II

Protects against condensation damage in long distance railroad or cargo shipments.

- Calcium chloride traps moisture.

Individual Bags – 32 bags recommended per 20 ft. container.

Continu-Strip – 6 adhesive-backed bags per strip for applying to container walls.

EZ Hang Pole – Long desiccant bag with wooden spine and hook for easy hanging inside containers. Extends your reach without stools or step ladders.

Cargo Bag – Large bags with clip-on hook to hang or suspend in containers, railcars and barges.

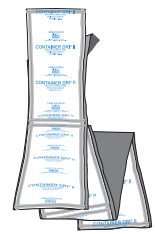

CONTINU-STRIP S-7933



EZ HANG POLE S-15068

MODEL NO.	DESCRIPTION	GRAM SIZE	BAGS TO FIT CONTAINER		BAG DIMENSIONS	BAGS/ CTN.	LBS./ CTN.	PRICE/CARTON	
			20 FT.	40 FT.				1	2+
S-5168	Individual Bags	125	32	64	10 x 5¾ x 1"	32	9	\$68	\$65
S-7933	Continu-Strip	750				72	24	153	145
S-15068	EZ Hang Pole	750	6	12	8 x 39 x 1½"	6	11	180	172
S-14045	Cargo Bag	1,500	3	6	18 x 22 x 1½"	6	25	\$209/carton	

# STRING SEWN

Hang inside crates or tie to large equipment during shipping or storage.

- Activated clay adsorbs moisture.
- Tough non-woven rayon/polyester bag.

MEETS MIL. SPEC. MIL-D-3464E TYPE I AND II

MODEL NO.	BAG DIMENSIONS	UNIT SIZE	PROTECTS CU. FT.	BAGS/ DRUM	LBS./ DRUM	PRICE PER DRUM		
						1	2	4+
S-11204	4¾ x 9½ x 1½"	16	13.33	150	188	\$413	\$398	\$385
S-2854	8¾ x 12½ x 2¼"	80	66.67	30	194	321	306	293

SHIPS VIA MOTOR FREIGHT

# DRI-CARD™ DESICCANTS



Small, flat shape fits in tight packages. Highly visible in powders.

- Widely used in food, pharmaceutical and diagnostic industries.
- Calcium chloride adsorbs moisture.
- Cards hold up to 50% of their weight in moisture.

FDA COMPLIANT

MODEL NO.	GRAM SIZE	CARD SIZE		PROTECTS CU. IN.	QTY./ CTN.	LBS./ CTN.	PRICE/CARTON		
		METRIC	INCHES				1	2	4+
S-19581	0.50	40 x 40 x 0.5 mm	1.57 x 1.57 x .02"	75	900	2	\$51	\$49	\$47
S-19582	1.21	60 x 60 x 0.5 mm	2.36 x 2.36 x .02"	170	1,200	5	130	125	120
S-19583	2.43	85 x 85 x 0.5 mm	3.35 x 3.35 x .02"	340	800	7	113	108	102

# DESI VIEW® DESICCANTS



Shows at a glance when desiccant needs replacing. Color changes from blue to pink.

- Protect electronics, aerospace and industrial products during transit or storage.
- Blue silica gel turns pink when moisture capacity has been reached.
- One side of bag is Tyvek®, other side is clear film.

5 GALLON PAILS

FDA COMPLIANT

MODEL NO.	UNIT SIZE	BAG DIMENSIONS	PROTECTS CU. FT.	BAGS/ CNTR.	LBS./ CNTR.	PRICE/CONTAINER		
						1	2	4+
S-20190	1/3	3 x 3½"	0.28	700	15	\$332	\$311	\$290
S-20191	2	5 x 4¾"	1.67	150	22	215	203	189



### KRAFT BAG – 5 GALLON PAILS

MODEL NO.	UNIT SIZE	BAG DIMENSIONS	PROTECTS CU. FT.	BAGS/ CNTR.	LBS./ CNTR.	PRICE PER CONTAINER		
						1	2	4+
S-1055	1/6	1 x 2½ x 1/4"	.14	1,200	24	\$140	\$133	\$127
S-1056	1/3	1 x 3½ x 1/4"	.28	700	25	110	104	100
S-1057	1/2	3 x 3 x 1/4"	.42	550	27	127	122	116
S-1058	1	3 x 4 x 1/4"	.83	300	27	96	92	86
S-1059	2	3 x 6 x 3/8"	1.67	150	27	72	70	66

### KRAFT BAG – 34 GALLON DRUMS

S-2855	1	3 x 4 x 1/4"	.83	1,300	114	\$342	\$325	\$306
S-2856	2	3 x 6 x 3/8"	1.67	800	136	286	272	258
S-1604	4	5 x 5½ x 1/2"	3.33	500	162	277	265	251

SHIPS VIA MOTOR FREIGHT

### TYVEK® BAG – 5 GALLON PAILS

S-5163	1/6	1 x 2½ x 1/4"	.14	1,200	24	\$131	\$124	\$116
S-5164	1/3	1 x 3½ x 1/4"	.28	700	25	119	110	103
S-5165	1/2	3 x 3 x 1/4"	.42	550	27	134	127	120
S-5166	1	3 x 4 x 1/4"	.83	300	27	107	101	95
S-5167	2	3 x 6 x 3/8"	1.67	150	27	90	84	79

### TYVEK® BAG – 34 GALLON DRUMS

S-8029	1	3 x 4 x 1/4"	.83	1,300	114	\$343	\$326	\$310
S-8030	2	3 x 6 x 3/8"	1.67	800	136	328	310	296
S-8031	4	5 x 5½ x 1/2"	3.33	500	162	304	288	275
S-1605	8	5 x 8 x 1 1/8"	6.67	300	193	296	283	270
S-1606	16	5¼ x 10 x 1½"	13.33	150	189	242	232	222

SHIPS VIA MOTOR FREIGHT

## CLAY

Protect shipments from moisture and corrosion.

- Activated clay desiccants control humidity and eliminate risk of mildew or rust damage in sealed containers.
- Noncorrosive, nontoxic. Adsorbs up to 20% of its weight in water vapor in 6 hours.
- Works best at temperatures below 120°F.

### KRAFT BAGS

- Designed for machine parts, document storage, chemicals and clothing.

### TYVEK® BAGS

- Recommended for shipping pharmaceuticals, electronic components and food.
- Meets FDA specifications for contact with food and drugs.
- Tyvek® provides a tear-proof, dust-free packet.

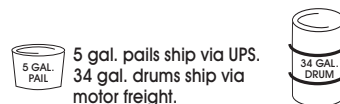

5 gal. pails ship via UPS.  
34 gal. drums ship via motor freight.

ALL BAGS MEET MIL. SPEC. MIL-D-3464E TYPE I AND II. QPL CERTIFIED.

### SILICA GEL PACKET – 5 GALLON PAILS

MODEL NO.	GRAM SIZE	BAG DIMENSIONS	PROTECTS CU. IN.	BAGS/ CNTR.	LBS./ CNTR.	PRICE PER CONTAINER		
						1	2	4+
S-8032	1/2	5/8 x 1 1/32"	24	6,000	12	\$229	\$214	\$196
S-3902	1	7/8 x 1 1/2"	47	5,000	18	219	203	186
S-3903	2	7/8 x 2 1/8"	94	3,000	18	200	186	170
S-3904	3	1 1/16 x 2 1/16"	141	2,000	19	175	169	152
S-3905	5	1 1/16 x 2 3/4"	235	1,250	20	156	145	131
S-3906	10	1 1/2 x 3 1/4"	470	600	18	206	195	175

## SILICA GEL

PACKET – Fast and extra adsorbent silica gel.

- Meets FDA specifications for food and drug products.
- Provides superior adsorption. Remains dry at maximum saturation.
- Silica gel can adsorb 15% of its weight in water vapor in 2 hours.





# VCI PAPER PRODUCTS



**ANTI-RUST PAPER**



**PRE-CUT SHEETS**



**WAXED**



**MIL SPEC**

## ULINE INDUSTRIAL

- Corrosion protection for ferrous metals.
- Ideal for domestic or international shipments.

## ULINE INDUSTRIAL PAPER SHEETS

- Time-saving pre-cut sheets for uniform size items or interleaving.

## ULINE HEAVY DUTY

- Protect steel, iron and other ferrous metals during long-term storage.

## WAXED

- Wax coating molds tightly around parts for storage.

## MIL SPEC

- pH neutral VCI paper meets Mil. Spec. MIL-PRF-3420.

## MULTI-METAL

- Protects ferrous, non-ferrous and combination metals including iron, steel, tin, zinc, aluminum and copper.

### INDUSTRIAL ROLLS

MODEL NO.	SIZE	DESCRIPTION	PRICE PER ROLL		
			1	3	6+
S-12819	12" x 200 yds.	Uline Industrial	\$37	\$36	\$34
S-14093	18" x 200 yds.		58	56	52
S-11202	24" x 200 yds.		66	64	60
S-7054	36" x 200 yds.		<b>\$90 per roll any qty.</b>		
S-11203	48" x 200 yds.		133	126	120

### INDUSTRIAL SHEETS

MODEL NO.	SIZE	SHEETS/BUNDLE	LBS./BUNDLE	PRICE PER BUNDLE		
				1	3	6+
S-14094	8 x 8"	1,000	7	\$45	\$42	\$40
S-16682	9 x 9"		9	49	46	43
S-13030	9 x 12"		11	65	61	58
S-13031	12 x 12"		15	81	76	73
S-23076	12 x 18"	500	11	65	61	58
S-14095	18 x 18"		16	87	84	81
S-16683	24 x 24"		31	163	155	146
S-20172	40 x 48"		200	41	228	217

### HEAVY DUTY ROLLS

MODEL NO.	SIZE	DESCRIPTION	PRICE PER ROLL		
			1	3	6+
S-6708	36" x 100 yds.	Uline Heavy Duty	\$80	\$71	\$65
S-6709	36" x 400 yds.		285	259	232

### WAXED ROLLS

MODEL NO.	SIZE	DESCRIPTION	PRICE PER ROLL		
			1	3	6+
S-16684	24" x 200 yds.	Waxed Rolls	\$108	\$103	\$96
S-16685	36" x 200 yds.		162	154	145

### MIL SPEC ROLLS

MODEL NO.	SIZE	DESCRIPTION	PRICE PER ROLL		
			1	3	6+
S-15432	36" x 200 yds.	Mil Spec	\$227	\$206	\$186

### MULTI-METAL ROLLS

MODEL NO.	SIZE	DESCRIPTION	PRICE PER ROLL		
			1	3	6+
S-16686	24" x 200 yds.	Multi-Metal Rolls	\$93	\$89	\$84
S-16687	36" x 200 yds.		141	134	126

## SILVER SAVER®



**ROLLS**



**BAGS**

Protect silver wire, jewelry and silver-plated parts during shipping and storage.

- Eliminate corrosion and tarnish. Protects up to 2 years.
- Chemically treated kraft paper removes sulfite vapors.

MODEL NO.	SIZE	QTY./CARTON	LBS./CARTON	PRICE PER CARTON		
				1	3	6+
S-14100	3 x 5"	250	1	\$64	\$56	\$50
S-16688	6 x 8"	Bags	4	106	97	89
S-23077	2" x 200 yds.	1 Roll	2	30	29	28
S-16689	18" x 200 yds.		15	150	145	140
S-14102	36" x 200 yds.		30	300	290	280

# VCI POLY PRODUCTS

Avoid using messy oil or grease when shipping metal parts.

- Corrosion inhibitor is embedded in durable polyethylene film.

## VCI POLY BAGS

Open-ended bags protect metal parts from rust.

- Heat sealable with Poly Bag Sealers, see pages 153-155.

## VCI RECLOSABLE POLY BAGS

Ship small to medium-sized metal gears and parts.

- Zip top seals tight. • Multi-metal protection.

## VCI POLY TUBING

Make your own custom-length VCI bags.

- Heavy-duty poly resists tearing.
- Heat sealable, odorless and nontoxic.

## VCI GUSSETED POLY BAGS

Protect bigger items or use as container liners.

- Perforated roll for easy dispensing.
- S-15448 and S-20169 work well as Gaylord liners.
- S-15449 makes a good pallet cover.



POLY BAGS



RECLOSABLE

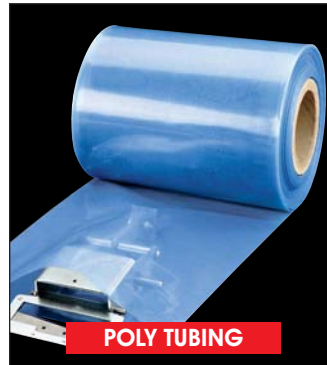

POLY TUBING



GUSSETED

### POLY BAGS – 4 MIL

MODEL NO.	SIZE	QTY./ CARTON	LBS./ CARTON	PRICE PER CARTON		
				1	3	6+
S-15305	3 x 5"	1,000	6	\$54	\$49	\$45
S-7055	4 x 6"		8	65	61	54
S-7056	6 x 8"		15	104	95	86
S-16730	8 x 10"		24	148	135	123
S-7057	9 x 12"		31	197	180	164
S-15306	10 x 12"	250	9	61	56	48
S-20162	12 x 12"		11	69	64	58
S-13032	12 x 18"		16	111	103	92
S-20163	12 x 20"		18	113	105	95
S-13033	18 x 24"		31	193	175	162
S-20164	20 x 20"	100	27	174	159	147
S-16731	24 x 36"		25	158	144	130

### POLY TUBING – 4 MIL

MODEL NO.	SIZE	LBS./ ROLL	PRICE PER ROLL		
			1	3	6+
S-19544	4" x 500'	7	\$68	\$64	\$60
S-19545	8" x 500'	15	119	111	104

### RECLOSABLE POLY BAGS – 4 MIL

MODEL NO.	SIZE	QTY./ CARTON	LBS./ CARTON	PRICE PER CARTON		
				1	3	6+
S-14096	3 x 5"	1,000	6	\$85	\$80	\$75
S-14097	4 x 6"		9	105	100	95
S-14098	6 x 8"		15	160	155	145
S-16732	8 x 10"		23	235	225	210
S-14099	9 x 12"		32	275	260	245
S-20165	10 x 12"	250	10	98	91	83
S-16733	12 x 18"		17	140	135	125

### GUSSETED POLY BAGS – 4 MIL

MODEL NO.	SIZE W x D x H	BAGS/ ROLL	LBS./ ROLL	PRICE PER ROLL		
				1	2	5+
S-20166	14 x 10 x 25"	250	39	\$267	\$256	\$247
S-20167	23 x 17 x 46"	100	51	302	293	282
S-20168	35 x 35 x 72"	40	60	323	313	303
S-15448	40 x 36 x 80"	25	49	282	272	261
S-20169	50 x 48 x 80"	20	47	298	288	277
S-15449	54 x 44 x 96"	20	50	343	334	324

# VCI POLY SHEETING

Create custom packaging for larger engine parts, bearings and other metal components.

### 4 MIL

MODEL NO.	SIZE	LBS./ ROLL	PRICE PER ROLL		
			1	3	6+
S-20170	20" x 500'	17	\$100	\$95	\$90
S-15446	36" x 500'	31	165	155	150
S-15447	48" x 500'	41	215	205	195

- Provide corrosion protection – Outdoors up to 6 months, indoors up to 12 months.



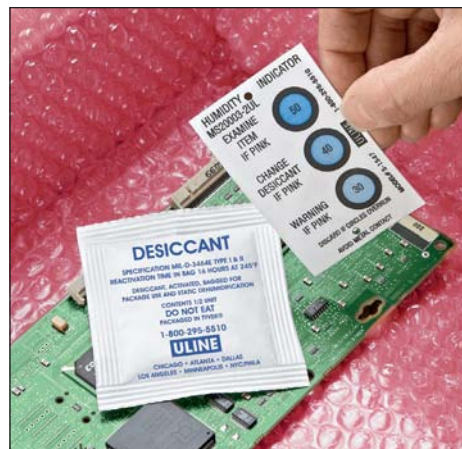

## HUMIDITY INDICATORS

Prevent costly damage to your sensitive shipments.

- Color changes from blue to pink as humidity level increases.
- Monitor expensive electronic equipment or optical instruments with the three-dot cards.

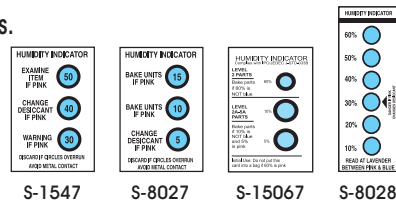

MODEL NO.	SIZE W x H	DOTS	HUMIDITY LEVELS	QTY./CAN	SUGGESTED USE	PRICE PER CAN (MIN. 2)		
						2	4	8+
S-1547	2 x 3"	3	30, 40, 50%	125	Sensitive Electronics	\$27	\$25	\$23
S-8027	2 x 3"	3	5, 10, 15%					
S-15067	2 x 3"	3	5, 10, 60%					
S-8028	1 1/8 x 4 3/4"	6	10,20,30,40,50,60%	200	All Purpose	37	34	31

## FREEZE INDICATOR



- Turns red when exposed to temperatures below 32°F/0°C.
- Non-resettable.

MODEL NO.	SIZE W x H	QTY./PKG.	PRICE PER PACKAGE		
			1	5	10+
S-3851	1.38 x .69"	10	\$73	\$69	\$65

## HEAT INDICATOR

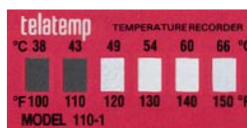

- Turns black as temp. rises. 100 to 150°F.
- 6 windows in 10°F increments.
- Non-resettable.

2-5 DAY LEAD TIME

MODEL NO.	SIZE W x H	QTY./PKG.	PRICE PER PACKAGE		
			1	5	10+
S-6710	1 1/4 x 3/4"	25	\$68	\$66	\$64

## VCI STRETCH WRAP



Secures and protects pallets of large metal parts for shipment or storage.

- Cast film prevents rust in ferrous and non-ferrous metals.
- Protects indoors up to two years.

S-16734 – Machine Length.

SOLD IN CASE QUANTITIES

MODEL NO.	SIZE	GA.	ROLLS/CASE	PRICE PER ROLL			
				1	4	8	16+
S-7058	18" x 1,500'	100	4	N/A	\$75	\$70	\$65
S-16734	20" x 4,500'		N/A	\$215	205	195	185

## OXYGEN-ABSORBING PACKETS



Preserve freshness and extend the shelf life of packaged foods.

- Prevents mold and bacteria growth.
- Removes over 99.9% of oxygen from sealed, airtight packages.

FDA COMPLIANT

MODEL NO.	SIZE	PACKET DIMENSIONS	PROTECTS CU. IN.	PACKETS/CTN.	LBS./CTN.	PRICE PER CARTON		
						1	2	4+
S-19584	30 cc	1 1/4 x 1 1/2"	9	6,000	23	\$205	\$195	\$185
S-19585	50 cc	1 1/2 x 1 3/4"	14	5,000	24	200	190	180
S-19586	100 cc	1 1/2 x 2 1/4"	28	2,500	22	145	140	135
S-23091	300 cc	2 x 2 3/8"	100	2,000	35	175	170	165

## VCI SHRINK FILM



One-piece coverage for metal equipment. Six times thicker than stretch wrap.

- Prevents rust. UV, water and puncture resistant.
- 6 month outdoor protection, 12 months indoors.
- Seal with Shrinkfast™ Heat Guns, page 232.

MODEL NO.	SIZE	MIL	ROLLS/CASE	PRICE PER ROLL		
				1	3	6+
S-20195	20' x 100'	6	1	\$350	\$330	\$320

## GREASE SPRAY



Prevent rust.

- Spray on metal parts or machinery.
- Safe on paints and plastics.
- Remove easily with alkaline cleaner.
- 1 year outdoor protection, 2 years indoors.

ZERUST®

MODEL NO.	NET OZ.	CANS/CASE	PRICE PER CAN (MIN. 2)		
			2	6	12+
S-23092	12	12	\$25	\$24	\$23



# SHIPPING INDICATORS

## DROP-N-TELL®

### NON-RESETTABLE

Indicates **shock damage** at a glance.

- **Best seller:** 25G range for most electronic equipment, glassware, etc.
- Attach self-stick detector to product or package exterior.
- Included warning labels affix to package and bill of lading.



### RESETTABLE

Indicator is easy to reset with the push of a pin.

- Perfect for packages frequently shipped back and forth.



### NON-RESETTABLE

MODEL NO.	RANGE	RECOMMENDED USE	PRICE PER CTN. OF 25		
			1	2	5+
S-2852	5G	Heavy Products	\$104	\$102	\$100
S-1471	10G	Sturdy Electronic Equipment			
S-2853	15G	Electronic Equipment			
S-867	25G	Fragile Items			
S-1472	50G	Sensitive/Fragile Items			
S-1473	100G	Very Sensitive			

### RESETTABLE

MODEL NO.	RANGE	RECOMMENDED USE	PRICE PER CTN. OF 25		
			1	2	5+
S-8021	5G	Heavy Products	\$112	\$109	\$105
S-8022	10G	Sturdy Electronic Equipment			
S-8023	15G	Electronic Equipment			
S-8024	25G	Fragile Items			
S-8025	50G	Sensitive/Fragile Items			
S-8026	100G	Very Sensitive			

## TIP-N-TELL®

Shows when packages tip in transit.

- Possible damage indicated when blue beads break through to top.
- Pull pin to activate.
- Receiver's warning label included.



MODEL NO.	QTY./CTN.	PRICE PER CARTON				
		1	2	3	5	10+
S-866	100	\$155	\$151	\$145 per carton		

## SHOCKWATCH®

### NON-RESETTABLE

Label indicates possible **damage during shipping**.

- Vial turns red to show impact. Activates automatically when dropped.
- Large 3¾ x 3¾" size alerts handlers and is a permanent record of rough handling.



MODEL NO.	DESC.	RANGE	QTY./BOX	RECOMMENDED USE	PRICE PER BOX		
					1	2	4+
S-6690	Yellow	25G	50	Heavy Products	\$170 any qty.		
S-8020	Purple	37G		Furniture			
S-5158	Red	50G		Electronic Equip.			
S-5159	Orange	75G		Sturdy Electronics			
S-5160	Green	100G		Sensitive Electronics			
S-6691	Companion Label		200/Roll			\$75	

■ SHIPS VIA MOTOR FREIGHT



### S-6691 COMPANION LABEL

Alerts handlers to proper procedures to receive damaged shipments. Shockwatch® 2, see [uline.com](http://uline.com)

## TILTWATCH® XTR

Monitor shipments that must remain upright.

- Activates at 80° tilt.
- Indicator turns from white to red if package has been tilted.
- Consecutively numbered.



**Companion Label** – Alerts handlers to proper procedures to receive damaged shipments.

MODEL NO.	DESCRIPTION	PRICE PER CARTON OF 100			
		1	2	5	10+
S-5571	TiltWatch® XTR	\$152	\$149	\$146	\$143
S-7932	Companion Label	200/Roll		\$75	

# 3M AEROSOLS



SUPER 77



HI-STRENGTH 90



FOAM FAST 74



RUBBER AND VINYL 80



ADHESIVE REMOVER



SILICONE LUBRICANT

MODEL NO.	DESCRIPTION	USE	NET OZ./CAN	PRICE PER CAN (MIN. 2)		
				2	12	24+
S-515	Super 77 Adhesive	Cartons/Foam	17	\$28	\$27	\$26
S-24722	Super 77 Low VOC Adhesive		14	23	\$19 per can	
S-24723	Hi-Strength 90 Adhesive	Wood/Plastic	14	29	28	27
S-22033	Hi-Strength 90 Low VOC Adhesive		19	30	29	28
S-12734	Foam Fast 74 Adhesive	Foam	17	35	34	33
S-15829	Rubber and Vinyl 80 Adhesive	Rubber/Vinyl	19	31	30	29
S-17291	Adhesive Remover	Dirt/Grease	18.5	41	40	39
S-22032	Adhesive Remover Low VOC		19			
S-522	Silicone Lubricant	Moving Parts	13	24	23	22
S-18768	Silicone Lubricant Low VOC		13	23	22	21

- SUPER 77: Fast, aggressive tack.
- HI-STRENGTH 90: Strong, contact-type adhesive for heavy-duty bonding.
- FOAM FAST 74: Glue foam to wood, metal and plastics.
- RUBBER AND VINYL 80: High-temperature contact adhesive.
- ADHESIVE REMOVER: Dissolves and flushes away most non-curing adhesive films.
- SILICONE LUBRICANT: Eliminates squeaks. Long-lasting lubrication.

## ULINE SILICONE LUBRICANTS



Lubricates moving parts and seals out moisture.

- Recommended for conveyors, hinges, gears and locks.
- Protects against rust/corrosion.
- Industrial strength at an economical price.

MODEL NO.	DESCRIPTION	NET OZ./CAN	PRICE PER CAN (MIN. 2)			
			2	12	24	48+
S-19036	Silicone Lubricant	10.5	\$11	\$10	\$9	\$8
S-24261	Silicone Lubricant Low VOC	13				

## WHITE LITHIUM LUBRICANT New

Outdoor lubrication that won't freeze, melt or wash off.

- Reduces friction for metal-to-metal contact like hitches, hinges and rails.
- Operates in sub-zero temps down to -40°F.



### LIQUID WRENCH®

MODEL NO.	DESCRIPTION	NET OZ./CAN	CANS/CASE	PRICE PER CAN (MIN. 2)		
				2	12	24+
S-25326	White Lithium Grease	10	12	\$12	\$11	\$10

## SPRAYWAY® CLEANERS



### BRAKE PARTS

Quickly remove brake fluid and oil from metal components.

- Dries instantly with no residue.
- Chlorinated** – Cleans 2x faster.  
**Ultra Low VOC** – 50-state compliant. Non-chlorinated.

MODEL NO.	DESCRIPTION	NET OZ./CAN	CANS/CASE	PRICE PER CAN (MIN. 2)		
				2	12	24+
S-25323	Chlorinated	19	12	\$10	\$9	\$8
S-25324	Ultra Low VOC	15				

### ELECTRICAL CONTACT

Deep clean electrical parts, batteries and switches.

- Quick dry. Leaves no residue.
- Safe to use on plastics.
- 50-state compliant.



MODEL NO.	DESCRIPTION	NET OZ./CAN	CANS/CASE	PRICE PER CAN (MIN. 2)		
				2	12	24+
S-25325	Electrical Contact	13.5	12	\$14	\$13	\$12



## ULINE AIR IN A CAN

Remove lint, dust and dirt from electronics, keyboards, computers.

- Extended nozzle cleans hard-to-reach places.
- Portable 12 oz. can recommended for warehouse and office use.

MODEL NO.	NET OZ./ CAN	CANS/ CASE	PRICE PER CAN (MIN. 2)				
			2	6	12	24	48+
S-6771	12	12	\$9.95	\$9.45	<b>\$7.45 per can</b>		



## ULINE MASKOUT PAINT

- Save on added costs for new cartons, crates or drums.
- Maskout quickly covers old markings. Makes old cartons look like new.
- Reusable snap-on spray gun keeps hands clean. Easy to spray.

**Free Offer:**

Free H-505 Spray Can Gun with 24+ can purchase.

MODEL NO.	COLOR	NET OZ./ CAN	CANS/ CASE	PRICE PER CAN (MIN. 2)				
				2	6	12	24	48+
S-249	Tan	13	12	\$8.30	\$8.10	\$7.70	\$7.30	\$6.90
S-290	White	12						
H-505	Spray Can Gun			\$2.50 ea.	\$2.30 ea.	\$2.10 ea.	\$2.00 ea.	\$1.80 ea.



## ULINE SPRAY ADHESIVES

- A pressure-sensitive adhesive for bonding shipping labels, forms, documents, corrugated, paper, wood, cloth, plastics, film, etc.
- Excellent for adhering polyurethane or rubber foams to other packing materials. Just spray and stick.

Heavy Duty S-15802 – High strength for wood, glass or plastic.

**Free Offer:**

Free H-505 Spray Can Gun with 24+ can purchase.

MODEL NO.	NET OZ./ CAN	CANS/ CASE	PRICE PER CAN (MIN. 2)				
			2	6	12	24	48+
S-313	11½	12	\$11.00	\$10.75	<b>\$8.75 per can</b>		
S-15802	12		12.00	11.75	<b>\$9.75 per can</b>		



S-6772

## WD-40®

Makes almost everything work better.

- Multipurpose lubrication helps prevent rust and frees stuck parts.

S-6772 – Smart straw for precise application.



S-12737

MODEL NO.	NET WT./ CAN	QTY./ CASE	PRICE PER CAN (MIN. 2)		
			2	4	12+
S-6772	11 oz.	12	\$13	\$12	\$11
S-12737	1 gal.	4	46	45	44

## GOOF OFF®

Remove tough stuff. Get the ugly bubble gum off your sidewalk.

- Removes grease, oil, tar, graffiti, dried paint and adhesive.
- Powerful formula penetrates deep into spots, stains and spills.



S-21466



S-19127

\* SOLD IN CASE QUANTITIES

MODEL NO.	NET WT./ CAN	QTY./ CASE	PRICE PER CAN		
			2-4	6-8	12+
S-19127	12 oz.	6	\$9.50	\$9.00	\$8.50
S-21466*	1 gal.	4	28.00	27.50	27.00



## DISPENSER BOX



## GLUE DOTS®

Attach samples, coupons and cards to products or mail pieces.  
Convenient dispenser box for easy removal. • Instantly bonds.

### LOW PROFILE

15 MIL

MODEL NO.	DOT DIAM.	STRENGTH (TACK)	RECOMMENDED FOR BONDING	QTY./ROLL	PRICE PER ROLL		
					1	8	16+
S-12911	1/4"	Medium	Removable – Cardstock/heavy paper	4,000	\$60	\$58	\$56
S-10676		High	Removable – Paper to product				
S-13603		Super High	Permanent – Product to product				
S-6647	1/2"	Low	Removable – Copy paper/thin paper	4,000	\$47 any quantity		
S-7586		Medium	Removable – Cardstock/heavy paper				
S-6648		High	Removable – Paper to product				
S-7587		Super High	Permanent – Product to product				

### MEDIUM PROFILE

55 MIL

S-11779	1/2"	Low	Removable – Copy paper/thin paper	2,000	\$38	\$36	\$34
S-11780		Medium	Removable – Cardstock/heavy paper				
S-10677		High	Removable – Paper to product				
S-11781		Super High	Permanent – Product to product				

### HIGH PROFILE

100 MIL

S-10678	1/2"	High	Removable – Paper to product	1,000	\$48	\$46	\$44
S-11783		Super High	Permanent – Product to product				



## GLUE DOT DISPENSER AND ROLLS

### LOW PROFILE

15 MIL

MODEL NO.	DOT DIAM.	STRENGTH (TACK)	RECOMMENDED FOR BONDING	QTY./ROLL	PRICE PER ROLL		
					1	8	16+
S-10364	1/2"	Low	Removable – Copy paper/thin paper	1,500	\$18 any quantity		
S-10365		Medium	Removable – Cardstock/heavy paper				
S-10366		High	Removable – Paper to product				
S-10367		Super High	Permanent – Product to product				

### MEDIUM PROFILE

55 MIL

MODEL NO.	DOT DIAM.	STRENGTH (TACK)	RECOMMENDED FOR BONDING	QTY./ROLL	PRICE PER ROLL		
					1	8	16+
S-11784	1/2"	Medium	Removable – Cardstock/heavy paper	600	\$20	\$19	\$18
S-11785		High	Removable – Paper to product				
S-11786		Super High	Permanent – Product to product				

### STITCH PATTERN

#### LOW PROFILE

15 MIL

MODEL NO.	DOT DIAM.	STRENGTH (TACK)	RECOMMENDED FOR BONDING	QTY./ROLL	PRICE PER ROLL		
					1	8	16+
S-10679	1/4"	High	Removable – Paper to product	3,000	\$22	\$21	\$20
S-17185	1/4"	Super High	Permanent – Product to product				

### DOT SHOT® PRO DISPENSER

MODEL NO.	DESCRIPTION	SHPG. WT.	PRICE EACH		
			1	2	4+
H-1163	Dot Shot® Pro Dispenser	2 lbs.	\$55	\$50	\$47

Apply glue dots quickly.

- Easy roll-on dispensing action.
- Bond tags and paper to unusually shaped products.
- Creates a tight seal on irregular surfaces such as cans and bottles.

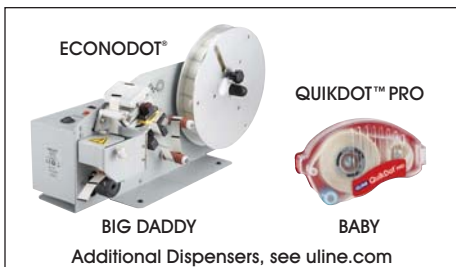

# ULINE DOUBLE-SIDED FILM TAPE

## ULINE GENERAL PURPOSE

3" CORE

MODEL NO.	SIZE	MIL	ROLLS/CASE	PRICE PER ROLL (MIN. 2 ROLLS)		
				2	16	36+
S-17123	1/4" x 60 yds.	3.5	188	\$5	\$4	\$3
S-7859	1/2" x 60 yds.		96	8	7	6
S-10524	3/4" x 60 yds.		64	9	8	7
S-7860	1" x 60 yds.		48	12	11	10
S-15718	2" x 60 yds.		24	24	22	20



**Uline General Purpose** – Wrap packages, prepare reports. Kraft paper liner.

## ULINE REMOVABLE

3" CORE

MODEL NO.	SIZE	MIL	ROLLS/CASE	PRICE PER ROLL (MIN. 2 ROLLS)		
				2	16	36+
S-15719	1/2" x 60 yds.	4.0	96	\$10	\$9	\$8
S-15720	1" x 60 yds.		48	20	18	16

**Uline Removable** – One side permanent, one side repositionable. No residue. For stickers, labels, signs.

## ULINE HIGH TACK

3" CORE

MODEL NO.	SIZE	MIL	ROLLS/CASE	PRICE PER ROLL (MIN. 2 ROLLS)		
				2	16	36+
S-15721	1/2" x 60 yds.	5.0	96	\$11	\$10	\$9
S-15722	1" x 60 yds.		48	22	20	18

**Uline High Tack** – High performance. For quick, high-shear bonding of plastic, papers.

## ULINE HEAVY DUTY

3" CORE

MODEL NO.	SIZE	MIL	ROLLS/CASE	PRICE PER ROLL (MIN. 2 ROLLS)		
				2	16	36+
S-23240	1/2" x 55 yds.	8.0	20	\$15	\$14	\$13
S-23756	1" x 55 yds.		10	30	28	26

**Uline Heavy Duty** – Strong solvent acrylic adhesive sticks to nearly any surface. Mount signs, hem banners.

# 3M DOUBLE-SIDED FILM TAPE

## 3M 9415PC REMOVABLE – The "Post-It" tape.

3" CORE

MODEL NO.	SIZE	MIL	ROLLS/CASE	PRICE PER ROLL (MIN. 2 ROLLS)		
				2	16	36+
S-10103	1/2" x 72 yds.	2.0	72	\$52	\$49	\$47
S-10104	3/4" x 72 yds.		48	71	65	62
S-10105	1" x 72 yds.		36	87	82	79



**Strong, double-sided adhesive works for many applications and surfaces, including metal, glass and plastic.**

## 3M 9425 REMOVABLE – For papers, plastics, films.

S-10099	1/2" x 72 yds.	5.8	18	\$68	\$64	\$62
S-10100	3/4" x 72 yds.		12	90	83	80
S-10101	1" x 72 yds.		9	112	106	101

## 3M 444 HI TACK – Easy release liner. For bonding plastics.

3" CORE

MODEL NO.	SIZE	MIL	ROLLS/CASE	PRICE PER ROLL (MIN. 2 ROLLS)		
				2	16-18	36+
S-7185	1/2" x 36 yds.	4.0	72	\$29	\$28	\$27
S-7186	1" x 36 yds.		36	45	41	40
S-10085	2" x 36 yds.		24	86	83	79

## 3M 9576 LIGHT DUTY – Paper splicing and attaching.

S-10092	3/4" x 60 yds.	4.0	48	\$21	\$20	\$19
S-10093	1" x 60 yds.		36	29	25	24
S-10094	2" x 60 yds.		24	54	51	49

## 3M GPT-020 DOUBLE-COATED – Bonds to stainless steel and wood.

3" CORE

MODEL NO.	SIZE	MIL	ROLLS/CASE	PRICE PER ROLL (MIN. 2 ROLLS)		
				2	10	20+
S-16638	3/4" x 60 yds.	6.7	48	\$49	\$47	\$44
S-16639	1" x 60 yds.		36	62	57	56

S-24954	1/2" x 55 yds.	7.9	20	\$12	\$11	\$10
S-24955	1" x 55 yds.		10	23	22	20

# 3M DOUBLE-SIDED EXTENDED LINER TAPE

Seal corrugated express boxes or expedited envelopes. Extra wide liner.

- Clear polypropylene film with high tack synthetic rubber adhesive and kraft paper liner.

## 3M 476XL

MODEL NO.	SIZE	MIL	ROLLS/CASE	PRICE PER ROLL (MIN. 2 ROLLS)		
				2	6	12+
S-10089	1/2" x 360 yds.	6.0	12	\$66	\$63	\$60
S-10090	3/4" x 540 yds.		8	144	140	130
S-10091	1" x 540 yds.		6	189	181	177

- Resists temperatures to 120°F.
- Stated widths include the dry edges of the liner.



## DOUBLE-SIDED MASKING TAPE

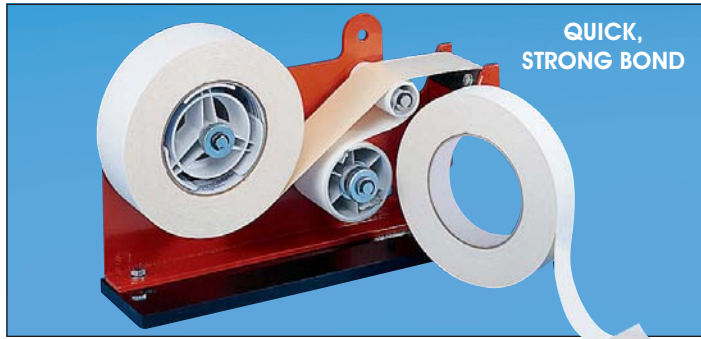

Thick tape with sticky natural rubber provides excellent adhesion.

**Uline Industrial** – Bonds everything from golf grips to picture frames.

**3M 410M** – Use for laminating and splicing or mounting printing plates.

Dispenser available, see [uline.com](http://uline.com)

### ULINE INDUSTRIAL

MODEL NO.	SIZE	MIL	ROLLS/CASE	PRICE/ROLL (MIN. 2)		CASE PRICE
				2	12+	
S-9793	1/2" x 36 yds.	7.0	72	\$8	\$7	\$432
S-10533	3/4" x 36 yds.		48	10	9	384
S-6758	1" x 36 yds.		36	<b>\$11 per roll</b>		396
S-6759	2" x 36 yds.		24	25	24	552
S-14486	3" x 36 yds.		12	34	33	396

### 3M 410M

MODEL NO.	SIZE	MIL	ROLLS/CASE	PRICE/ROLL (MIN. 2)		CASE PRICE
				2	12+	
S-11921	1/2" x 36 yds.	5.0	72	\$23	\$22	\$1,512
S-12907	3/4" x 36 yds.		48	30	29	1,344
S-6760	1" x 36 yds.		36	36	35	1,224
S-6761	2" x 36 yds.		24	72	70	1,632

## 3M SINGLE-SIDED FOAM TAPE



Seals out light, dust and moisture. Cushions vibration and deadens sound.

- Weatherproof windows; seal appliances and computers.
- Resists weather and UV rays.
- Handles temperatures to 150°F.
- Black vinyl foam with acrylic adhesive and paper liner.

### 3M 4504 HIGH DENSITY – 90 LB. TENSILE STRENGTH

MODEL NO.	SIZE	THICKNESS	ROLLS/CASE	LBS./CASE	PRICE PER ROLL		
					1	3	6+
S-10305	3/4" x 18 yds.	1/4"	12	21	\$117	\$115	\$110
S-10306	1" x 18 yds.		9	21	149	142	136
S-18873	2" x 18 yds.		6	31	300	286	273

### 3M 4516 HIGH DENSITY – 130 LB. TENSILE STRENGTH

MODEL NO.	SIZE	THICKNESS	ROLLS/CASE	LBS./CASE	PRICE PER ROLL		
					1	3	6+
S-17846	1/4" x 36 yds.	1/16"	36	14	\$54	\$52	\$50
S-15008	1/2" x 36 yds.		18	17	85	82	77
S-10303	3/4" x 36 yds.		12	14	110	105	101
S-10304	1" x 36 yds.		9	15	140	134	129
S-18636	2" x 36 yds.		6	18	279	266	257

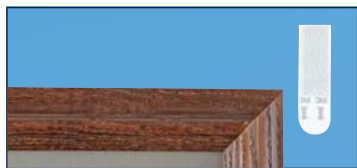

## 3M COMMAND™ PICTURE HANGING STRIPS

Decorate worry free. No nails, marks or residue.

- Recommended for framed pictures, artwork and clocks.
- Stick securely to most smooth surfaces. • Clean removal.



### 3M 17202 – SMALL STRIPS

MODEL NO.	PACK	DIMENSIONS	LOAD CAP.	PRICE/PACK (MIN. 9 PACKS)		
				9	18	27+
S-19700	4 sets	2½ x 5/8 x 1/10"	4 lbs.	\$4.50	\$4.25	\$4.05

### 3M 17206 – LARGE STRIPS

MODEL NO.	PACK	DIMENSIONS	LOAD CAP.	PRICE/PACK (MIN. 6 PACKS)		
				6	12	24+
S-19702	4 sets	3½ x 3/4 x 1/16"	16 lbs.	\$5.80	\$5.50	\$5.25



## 3M LINT ROLLERS

3M quality keeps clothes neat and surfaces spotless.

- High tack adhesive with greater grabbing ability.
- Perforated sheets tear quickly and cleanly.

**Standard** – Removes pet hair, dust and sweater fuzz.

**Large Surface** – Extra-wide sheets pull tough-to-remove debris from furniture, floors and auto interiors.



### STANDARD

MODEL NO.	DESCRIPTION	SHEET SIZE	SHEETS/ROLL	ROLLS/CASE	PRICE/ROLL (MIN. 12)	
					12	36+
S-19409	Roller	4"	60	6	\$4.90	\$4.30
S-19410	Refill				4.20	3.60

### LARGE SURFACE

MODEL NO.	DESCRIPTION	SHEET SIZE	SHEETS/ROLL	ROLLS/CASE	PRICE/ROLL (MIN. 4)	
					4	12+
S-24212	Roller	8"	60	4	\$11.75	\$11.25
S-24213	Refill				9.75	8.75



# DOUBLE-SIDED FOAM TAPE

**Uline Economy and 3M 4032** – Affordably priced for general-purpose applications.

**Uline Industrial and 3M 4016** – Securely bond signs and displays to a variety of surfaces.

**Uline Heavy Duty and 3M 4008** – Mount heavier material such as mirrors and acoustic panels.

**Uline Removable** – Temporarily hang POP displays, signage and artwork.

**3M 4004** – Strongest foam. Mount mirrors and plaques.

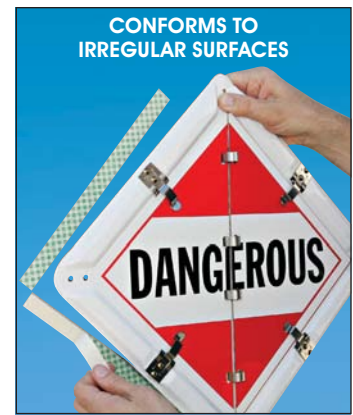

**ULINE** SPECIFY COLOR: White or Black

MODEL NO.	DESCRIPTION	SIZE	THICKNESS	ROLLS/CASE	PRICE PER ROLL (MIN. 2)		
					2	12	24+
S-9760		1/2" x 72 yds.		24	\$13	\$12	\$11
S-10529	Economy	3/4" x 72 yds.	1/32"	16	18	17	16
S-6755		1" x 72 yds.		12	21	20	19

S-3791		1/2" x 36 yds.		24	\$9	\$8	\$7
S-10530	Industrial	3/4" x 36 yds.	1/16"	16	12	11	10
S-3792		1" x 36 yds.		12	16	15	14
S-11694		2" x 36 yds.		6	31	29	26

S-7824		1/2" x 36 yds.		24	\$10	\$9	\$8
S-14690	Heavy Duty	3/4" x 36 yds.	1/8"	16	14	13	12
S-7825		1" x 36 yds.		12	19	18	16

S-16068*	Removable	1/2" x 36 yds.	1/16"	24	\$9	\$8	\$7
S-16069*		1" x 36 yds.		12	16	15	14

\*White only

**3M**

MODEL NO.	DESCRIPTION	SIZE	THICKNESS	ROLLS/CASE	PRICE PER ROLL (MIN. 2)		
					2	9	18+
S-10053		1/2" x 72 yds.		18	\$126	\$120	\$115
S-10054	3M 4032	3/4" x 72 yds.	1/32"	12	162	157	151
S-10055		1" x 72 yds.		9	199	194	185

S-6756		1/2" x 36 yds.		18	\$82	\$77	\$68
S-10063	3M 4016	3/4" x 36 yds.	1/16"	12	104	101	93
S-6757		1" x 36 yds.		9	121	116	111
S-10064		1 1/2" x 36 yds.		6	184	176	163

S-7826		1/2" x 36 yds.		18	\$112	\$105	\$99
S-10065	3M 4008	3/4" x 36 yds.	1/8"	12	146	139	129
S-7827		1" x 36 yds.		9	184	176	163
S-10066		2" x 36 yds.		6	361	342	327

S-10057	3M 4004	1/2" x 18 yds.	1/4"	18	\$105	\$102	\$98
S-10058		1" x 18 yds.		9	178	167	160

# PRE-CUT DOUBLE-SIDED FOAM SQUARES

**ULINE PRE-CUT DOUBLE-SIDED FOAM SQUARES**

MODEL NO.	SIZE	# SQUARES PER ROLL	THICKNESS	CORE SIZE	PRICE PER ROLL		
					1	12	24+
S-10531	1/2 x 1/2"	1,296					
S-11695	3/4 x 3/4"	864	1/32"	3"	\$19 per roll		
S-7852	1 x 1"	648					
S-13708	1/2 x 1/2"	1,296	1/16"	3"	\$19 per roll		
S-11696	1 x 1"	324					

**3M 4026 SQUARES**

MODEL NO.	SIZE	# SQUARES PER CASE	THICKNESS	PRICE PER CASE		
				1	2	4+
S-10062	1 x 1"	1,000	1/16"	\$193	\$182	\$178

**ULINE REMOVABLE DOUBLE-SIDED FOAM SQUARES**

MODEL NO.	SIZE	# SQUARES PER ROLL	THICKNESS	CORE SIZE	PRICE PER ROLL		
					1	12	24+
S-11697		648	1/32"		\$23	\$21	\$19
S-13709	1 x 1"	324	1/16"	3"	18	17	16



**Foam Squares** – Convenient for bonding small signs and placards.

**3M 4026 Squares** – Individual pre-cut squares fit in tool box or pocket.



**Removable Squares** – Specially designed adhesive for easy removal.

**Foam Strips** – Hang safety and information signs in offices and warehouses.

**ULINE PRE-CUT DOUBLE-SIDED FOAM STRIPS**

MODEL NO.	SIZE	# STRIPS PER ROLL	THICKNESS	CORE SIZE	PRICE PER ROLL		
					1	12	24+
S-10532		216	1/32"		\$23	\$21	\$19
S-13710	1 x 3"	324	1/16"	3"	29	27	25



### 3M 4932 and 4952

- Bonds slick or glossy surfaces such as polystyrene, polypropylene and powder-coated materials.
- White acrylic foam with rubber adhesive on kraft paper liner.

### 3M 5925, 5952 and 5962

- Molds to irregular and textured surfaces.
- Bonds well to painted and powder-coated metals.
- Dampens noise, shock and vibration.
- Black foam with acrylic adhesive; red polyethylene film liner.

### 3M 4905 and 4910

- 3M's clear VHB™ tape bonds transparent materials such as glass and acrylics.
- Mount signs on glass.
- Clear acrylic with acrylic adhesive.

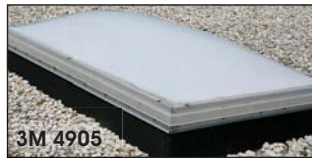

### 3M 4945

- Bonds vinyl trim and prepainted signs on trucks and trailers.
- Resists moisture, UV, solvents and plasticizers.
- White acrylic foam with acrylic adhesive; kraft paper liner.

### 3M F9460PC, F9469PC and F9473PC

- Adhesive transfer VHB™ provides high holding power and virtually invisible bonds.
- Bond smooth, flat metal surfaces.
- Attach office and warehouse signs or decorative metal trim.
- Clear acrylic adhesive on kraft paper liner.



MODEL NO.	DESC.	SIZE	TENSILE STRENGTH	MIL	ROLLS/CASE	PRICE PER ROLL			
						1	3	6+	
S-10141	3M 4932	1/2" x 72 yds.	100 lbs.	25	18	\$371	\$360	\$347	
S-10142		3/4" x 72 yds.				492	476	462	
S-10143		1" x 72 yds.				607	590	572	
S-16177	3M 4952	1/2" x 36 yds.	80 lbs.	45	18	196	190	187	
S-16178		3/4" x 36 yds.				261	254	248	
S-16179		1" x 36 yds.				332	326	314	
S-10151	3M 5925	1/2" x 72 yds.	75 lbs.	25	18	199	194	190	
S-10152		1" x 72 yds.				330	322	315	
S-23925	3M 5952	1/4" x 36 yds.	70 lbs.	45	36	65	63	60	
S-11931		1/2" x 36 yds.				18	105	102	99
S-11932		3/4" x 36 yds.				12	139	135	132
S-11933		1" x 36 yds.				9	178	173	165
S-23926		2" x 36 yds.				6	342	335	330
S-16408	3M 5962	1" x 36 yds.	70 lbs.	62	9	202	195	189	
S-10123	3M 4905	1/2" x 72 yds.	100 lbs.	20	18	170	167	162	
S-10124		3/4" x 72 yds.				12	228	222	217
S-10125		1" x 72 yds.				9	283	276	270
S-16209	3M 4910	1/4" x 36 yds.	100 lbs.	40	36	60	56	54	
S-10111		1/2" x 36 yds.				18	95	92	89
S-10112		3/4" x 36 yds.				12	125	121	119
S-10113		1" x 36 yds.				9	153	151	148
S-10129	3M 4945	1/2" x 36 yds.	140 lbs.	45	18	172	166	160	
S-10130		3/4" x 36 yds.				12	232	220	215
S-10131		1" x 36 yds.				9	289	281	270
S-18662	3M F9460PC	1/2" x 60 yds.	100 lbs.	2	72	40	38	37	
S-14906		1" x 60 yds.				36	68	66	65
S-18663	3M F9469PC	1/4" x 60 yds.	100 lbs.	5	144	33	32	30	
S-10106		1/2" x 60 yds.				72	50	49	48
S-16123		3/4" x 60 yds.				48	65	63	59
S-10107		1" x 60 yds.				36	82	78	75
S-16124		2" x 60 yds.				24	156	151	144
S-15917		4" x 60 yds.				8	331	319	307
S-10108	3M F9473PC	1/2" x 60 yds.	100 lbs.	10	18	88	85	83	
S-10109		3/4" x 60 yds.				12	119	115	111
S-10110		1" x 60 yds.				9	150	145	142
S-16127		2" x 60 yds.				6	306	294	285
S-14883		4" x 60 yds.				2	597	579	565

# 3M VHB™ TAPE

MODEL NO.	DESC.	SIZE	TENSILE STRENGTH	MIL	ROLLS/CASE	PRICE PER ROLL		
						1	3	6+
S-10120		1/2" x 72 yds.			18	\$240	\$232	\$226
S-10121	3M 4920	3/4" x 72 yds.	160 lbs.	15	12	317	309	302
S-10122		1" x 72 yds.			9	397	386	377
S-10138		1/2" x 72 yds.			18	257	250	244
S-10139	3M 4929	3/4" x 72 yds.	160 lbs.	25	12	343	334	326
S-10140		1" x 72 yds.			9	429	417	406
S-10126		1/2" x 72 yds.			18	243	236	231
S-10127	3M 4930	3/4" x 72 yds.	160 lbs.	25	12	325	316	309
S-10128		1" x 72 yds.			9	388	379	369
S-18639		1/4" x 36 yds.			36	92	90	87
S-10144	3M 4949	1/2" x 36 yds.	140 lbs.	45	18	150	144	140
S-10145		3/4" x 36 yds.			12	199	193	188
S-10146		1" x 36 yds.			9	246	239	233
S-10117		1/2" x 36 yds.			18	129	126	121
S-10118	3M 4950	3/4" x 36 yds.	140 lbs.	45	12	171	166	162
S-10119		1" x 36 yds.			9	213	207	202
S-14884		2" x 36 yds.			6	420	408	399
S-14945		1/2" x 36 yds.			18	171	165	158
S-14946	3M 4959	3/4" x 36 yds.	75 lbs.	120	12	230	220	212
S-14947		1" x 36 yds.			9	290	277	263
S-10147		1/2" x 72 yds.			18	229	221	212
S-18637	3M 4926	3/4" x 72 yds.	95 lbs.	15	12	306	295	285
S-11905		1" x 72 yds.			9	377	365	353
S-10132		1/2" x 72 yds.			18	241	235	226
S-10133	3M 4936	3/4" x 72 yds.	90 lbs.	25	12	324	314	303
S-10134		1" x 72 yds.			9	402	389	377
S-10114		1/2" x 36 yds.			18	121	118	115
S-10115	3M 4941	3/4" x 36 yds.	85 lbs.	45	12	160	157	153
S-10116		1" x 36 yds.			9	200	196	191
S-17643		2" x 36 yds.			6	395	387	379
S-10135		1/2" x 36 yds.			18	129	127	123
S-10136	3M 4956	3/4" x 36 yds.	80 lbs.	62	12	174	168	164
S-10137		1" x 36 yds.			9	215	210	204
S-16180	3M 4991	1/2" x 36 yds.	70 lbs.	90	18	143	139	134
S-16181		1" x 36 yds.			9	239	231	223
S-14942		1/2" x 36 yds.			18	76	71	69
S-14943	3M 4611	3/4" x 36 yds.	90 lbs.	45	12	97	93	90
S-14944		1" x 36 yds.			9	123	117	112

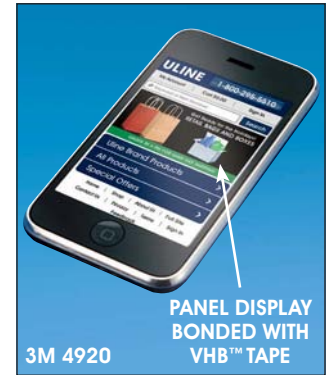

21st century tape. Replaces rivets, bolts, screws, welding and liquid adhesives.

- Incredible VHB™ strength guarantees a secure bond.
- Temperature range is -40° to 200°F.
- Water, solvent and UV resistant.

### 3M 4920, 4929, 4930, 4949, 4950 and 4959

- 3M's general purpose VHB™ tape.
- Recommended for bonding unpainted metals such as outdoor signs.
- 4920, 4930, 4950 and 4959 – White acrylic foam with acrylic adhesive.
- 4929 and 4949 – Black acrylic foam with acrylic adhesive.

### 3M 4926, 4936, 4941, 4956 and 4991

- Soft conformable foam molds to irregular surfaces.
- Bonds well to painted metals, plastic and glass such as mirrors.
- 4926, 4936, 4941, 4956 and 4991 – Dark gray foam with acrylic adhesive.

ULINE BONDING TAPE

Additional **BONDING** and **VHB™ TAPE**, see [uline.com](http://uline.com)



### 3M 4611

- Bonds bare metal surfaces. Use in painting, powder coating or high-temperature baking.
- Dark gray foam with acrylic adhesive.





# ULINE ADHESIVE TRANSFER TAPE

# 3M ADHESIVE TRANSFER TAPE

**ULINE**  
H-4730



Affix signs to pallets and warehouse shelves. 1" core rolls work with Uline and 3M dispensers.

**Economy** – Most economical way to attach lightweight items.

**Industrial** – Excellent adhesion to paper and plastic.

**Heavy Duty** – Recommended for uneven surfaces and signs.

**Uline Dispenser** – Fast loading, lightweight and easy to handle.

## ECONOMY

\* Fits H-1979 3M ATG-714 Dispenser

MODEL NO.	SIZE	MIL	ROLLS/ CASE	PRICE PER ROLL (MIN. 12 ROLLS)		
				12	1/2 CASE	1+ CASE
S-8408*	1/4" x 60 yds.	1.7	72	\$5.10	\$4.65	\$4.35
S-7822	1/2" x 36 yds.	1.7	72	<b>\$3.35 per roll</b>		
S-7823	3/4" x 36 yds.		48			

## INDUSTRIAL

▲ Works only with 3M ATG-700, see page 809

MODEL NO.	SIZE	MIL	ROLLS/ CASE	12	1/2 CASE	1+ CASE
S-17184	1/4" x 36 yds.	2.0	72	\$3.00	\$2.90	\$2.80
S-3055	1/2" x 36 yds.		72	5.45	5.20	4.95
S-17183▲	1/2" x 60 yds.	2.0	72	9.05	8.55	8.10
S-3056	3/4" x 36 yds.		48	7.60	6.90	6.70

## HEAVY DUTY

MODEL NO.	SIZE	MIL	ROLLS/ CASE	PRICE PER ROLL (MIN. 12 ROLLS)		
				12	1/2 CASE	1+ CASE
S-8409	1/2" x 18 yds.	5.0	144	\$6.30	\$5.90	\$5.60
S-8410	3/4" x 27 yds.		96	14.75	13.85	13.00

## DISPENSERS

• 1/4" adapter included

MODEL NO.	DESCRIPTION	MAX. CAPACITY	PRICE EACH	
			1	2+
H-4730•	Uline Dispenser	3/4" x 36 yds.	\$44	\$38
H-1979	3M ATG-714	1/4" x 60 yds.	82	77

## HAND DISPENSED



Attach signs, tags, placards to warehouse racks and skids.

**3M 920XL** – For smooth surfaces. Works well with coated papers and plastics.

**3M 465** – For light industrial use. Attach paper and plastic.

**3M 950** – Heavy duty bonding of metal, foam and vinyl.

**3M 9472LE** – Attach nameplates and labels on hard-to-stick surfaces.

## 3" CORE

MODEL NO.	DESCRIPTION	SIZE	MIL	ROLLS/ CASE	PRICE PER ROLL		
					1	3	12+
S-10030	3M 920XL	1/2" x 1,000 yds.	1.0	12	\$140	\$133	\$127
S-10031		3/4" x 1,000 yds.			9	204	195
					PRICE/ROLL (MIN. 6 ROLLS)		
					6	24	36+
S-18641		1/4" x 60 yds.		144	\$14	\$13	\$12
S-9785		1/2" x 60 yds.		72	18	17	16
S-9786	3M 465	3/4" x 60 yds.	2.0	48	26	24	22
S-9787		1" x 60 yds.		36	30	29	28
S-13992		2" x 60 yds.		24	59	57	55
S-9788	3M 950	1/2" x 60 yds.	5.0	72	35	34	33
S-9789		3/4" x 60 yds.		48	48	45	43
S-9790		1" x 60 yds.		36	59	58	57
S-14931		2" x 60 yds.		24	119	116	113
S-16125	3M 9472LE	1/2" x 60 yds.	5.2	18	37	35	34
S-10024		1" x 60 yds.		9	57	55	54
S-15939		2" x 60 yds.		6	119	115	112
S-15940		4" x 60 yds.		8	240	228	222

# 3M HIGH PERFORMANCE ADHESIVE TRANSFER TAPE



Attach nameplates, assemble point-of-purchase displays and splice metal coils. Hand dispensed.

**3M 467MP** – Attach paper, plastic and metal.

**3M 468MP** – Thicker, stronger adhesive. For rough, textured or uneven surfaces.

MAX. TEMPERATURE 400°F

MODEL NO.	DESCRIPTION	SIZE	MIL	ROLLS/ CASE	PRICE PER ROLL		
					1	2	4+
S-10042	3M 467MP	12" x 60 yds.	2.0	4	\$341	\$328	\$314
S-13993		24" x 60 yds.			1	683	659
S-13994	3M 468MP	12" x 60 yds.	5.0	4	456	438	420
S-13995		24" x 60 yds.			1	910	875

# 3M ADHESIVE TRANSFER TAPE



Attach signs, tags and placards to warehouse skids and racks. 1" core rolls work with 3M and Uline dispensers.

**987 Economy** – Attach signs, tags and placards to warehouse racks and skids.

**924 Industrial** – Excellent adhesion to paper and plastic.

**969 Heavy Duty** – Recommended for strong bonding.

**928 Repositionable** – Like a sticky note for temporary protective packaging.

**926 High Temperature** – Permanent bond for harsh environments.

**976 Smooth Surface** – Attach glossy coated paper, plastic and foam.

## 3M 987 ECONOMY

\* 1/4" adapter required

MODEL NO.	SIZE	MIL	ROLLS/ CASE	PRICE PER ROLL (MIN. 12 ROLLS)		
				12	1/2 CASE	1+ CASE
S-13822*	1/4" x 60 yds.	1.7	72	\$7.30	\$6.95	\$6.60
S-13823	1/2" x 36 yds.		72	5.25	5.10	4.90
S-14463	1/2" x 60 yds.		72	9.95	9.30	8.75
S-13824	3/4" x 36 yds.		48	8.40	8.05	7.70

## 3M 924 INDUSTRIAL

S-9794*	1/4" x 36 yds.	2.0	72	\$6.35	\$6.00	\$5.65
S-10048	1/2" x 11 yds.		72	4.60	4.35	4.25
S-5748	1/2" x 36 yds.		72	<b>\$7.65 per roll</b>		
S-9784	1/2" x 60 yds.		72	13.30	12.15	12.05
S-5749	3/4" x 36 yds.		48	11.60	10.65	10.40

## 3M 969 HEAVY DUTY

S-10051*	1/4" x 18 yds.	5.0	72	\$8.55	\$8.00	\$7.65
S-9795*	1/4" x 36 yds.		144	14.20	13.30	13.10
S-6753	1/2" x 18 yds.		72	11.75	11.00	10.55
S-10052	1/2" x 36 yds.		72	23.00	21.00	20.15
S-6754	3/4" x 18 yds.		48	15.65	14.35	14.00
S-11902	3/4" x 36 yds.		48	29.30	27.70	26.60

## 3M 928 REPOSITIONABLE

\* 1/4" adapter required

MODEL NO.	SIZE	MIL	ROLLS/ CASE	PRICE PER ROLL (MIN. 12 ROLLS)		
				12	1/2 CASE	1+ CASE
S-9762	1/2" x 18 yds.	2.0	72	\$9.50	\$9.00	\$8.55
S-10043	1/2" x 36 yds.		72	19.05	17.60	17.05
S-9763	3/4" x 18 yds.		48	12.95	12.35	11.85
S-10044	3/4" x 36 yds.		48	25.55	24.05	23.05

## 3M 926 HIGH TEMPERATURE

S-10045*	1/4" x 18 yds.	5.0	72	\$9.95	\$9.60	\$9.30
S-10046	1/2" x 18 yds.		72	12.70	12.30	11.75
S-15009	1/2" x 36 yds.		72	23.50	22.60	21.90
S-10047	3/4" x 18 yds.		48	16.85	16.35	15.70

## 3M 976 SMOOTH SURFACE

S-16122*	1/4" x 36 yds.	2.0	72	\$10.35	\$9.80	\$9.45
S-10049	1/2" x 36 yds.		72	14.90	14.40	13.85
S-10050	3/4" x 36 yds.		48	19.75	19.05	18.35

## DISPENSERS

Tape liner rewinds automatically inside.

**3M ATG-752C** – Straight, precise lines with easy-to-see extended roller. Handles 1/4" rolls with included adapter.

**3M ATG-700** – Rolls smooth, easy to load. Handles 1/4" rolls with adapter.

**3M ATG-714** – Handles 1/4" tape only. No adapter required.

MODEL NO.	DESCRIPTION	MAX. CAPACITY	PRICE EACH	
			1	2+
H-3620	3M ATG-752C	3/4" x 36 yds.	\$53	\$49
H-727	3M ATG-700	3/4" x 60 yds.	87	82
H-1979	3M ATG-714	1/4" x 60 yds.	82	77
H-727-1/4		1/4" adapter for H-727	\$20 each	

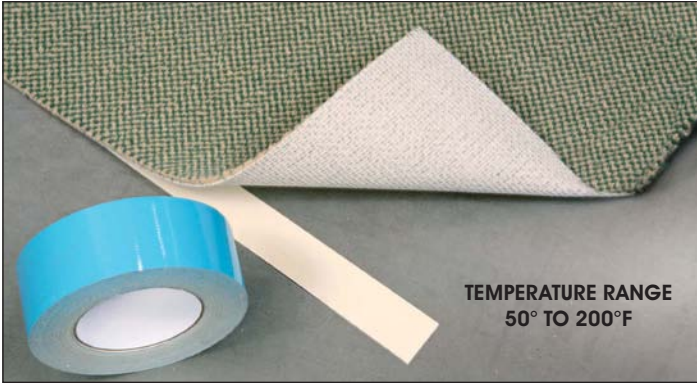

Holds carpet down. Use at convention sites, maintenance areas, office or home.

- Blue liner is silicone coated for easy unwind.
- Excellent adhesion. Leaves no residue.

### 3" CORE

MODEL NO.	SIZE	FILM THICKNESS	ROLLS/CASE	PRICE/ROLL (MIN. 3)		CASE PRICE
				3	12+	
S-14668	1" x 36 yds.	13.5 mil	48	\$12	\$11	\$480
S-12921	2" x 36 yds.		24	21	20	456
S-14669	3" x 36 yds.		16	29	28	432

## 3M DOUBLE-SIDED CARPET TAPE

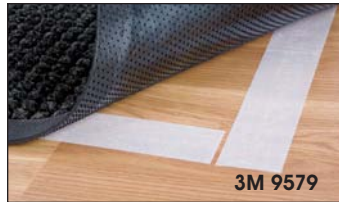

**3M 9589** – Tough enough to hold down carpet edges.

- Use for general mounting, joining and splicing.

**3M 9579** – Temporarily secure mats in trade show booths. Can also be used in warehouses and offices.

- Clean removal. Works on wood, concrete and linoleum.

## POLYETHYLENE FILM TAPE

### 3" CORE

MODEL NO.	DESC.	SIZE	MIL	ROLLS/CASE	PRICE/ROLL (MIN. 3)		CASE PRICE
					3	12+	
S-10086	3M 9589	1/2" x 36 yds.	9	72	\$24	\$23	\$1,584
S-10087		3/4" x 36 yds.		48	34	33	1,488
S-10088		1" x 36 yds.		36	42	40	1,404
S-12186		2" x 36 yds.		24	84	80	1,848
S-13952	3M 9579	1/2" x 36 yds.	9	72	14	13	864
S-13953		3/4" x 36 yds.		48	17	16	720
S-13954		1" x 36 yds.		36	21	20	684
S-13955		2" x 36 yds.		24	42	39	888

## WINDOW PROTECTION FILM



Saves energy. Filters light and solar heat.

**Window Tint** – For maximum reduction of sunlight.

**Mirror** – One-way viewing for storefronts and interview rooms.

**Privacy** – Frosted look for office partitions, bathrooms or laundry rooms.

**Security Film** – Holds shattered glass in place to prevent entry, injury or damage. Use in stores, offices and homes.

Accessories, see [uline.com](http://uline.com)

### WINDOW TINT – External Facing Windows

Dry Adhesive

MODEL NO.	DESC.	ROLL SIZE	MIL	% OF LIGHT BLOCKED	PRICE PER ROLL		
					1	2	4+
S-18272	Dark Tint	36" x 25'	1.7	78%	\$182	\$172	\$162
S-23615		48" x 25'			226	216	206
S-18273		60" x 25'			271	261	251

### MIRROR FILM – Windows and Glass Doors

Dry Adhesive

S-21803	One-Way Mirror	36" x 25'	2.3	95%	\$210	\$200	\$190
S-23616		48" x 25'			270	257	245
S-21804		60" x 25'			330	315	300

### PRIVACY FILM – Interior Windows

Pressure Sensitive Adhesive

S-18274	Frosted White	36" x 25'	2.8	25%	\$152	\$142	\$132
S-23617		48" x 25'			187	177	167
S-18275		60" x 25'			223	213	203

### SECURITY FILM

Pressure Sensitive Adhesive

MODEL NO.	COLOR	ROLL SIZE	MIL	% OF UV BLOCKED	PRICE PER ROLL		
					1	2	4+
S-18621	Clear	36" x 25'	2.5	95%	\$158	\$153	\$148
S-23619		48" x 25'			202	195	187
S-18622		60" x 25'			247	237	227
S-23189	Clear	36" x 25'	4.0	99%	185	180	175
S-23620		48" x 25'			230	222	215
S-23190		60" x 25'			275	265	255



## CARPET

Protect carpeting from damage while moving.



- Clear film with adhesive backing.
- Easy to remove. Leaves no residue.
- Applicator unrolls film onto carpet in one easy step.

MODEL NO.	ROLL SIZE	MIL	LBS./ROLL	PRICE PER ROLL		
				1	2	4+
S-7076	24" x 200'	2.5	7	\$59	\$55	\$50
S-12922	24" x 500'		16	116	107	97
S-19221	30" x 200'		8	75	69	62
S-7589	36" x 200'		9	\$74 per roll any qty.		
S-11726	36" x 500'		25	150	140	125
S-12923	48" x 200'	4.0	12	100	92	84
S-14522	48" x 500'		31	190	175	165
S-23540	24" x 200'		12	110	105	100
S-23541	36" x 200'	18	170	160	155	
H-3796	24, 30 and 36" Tape Applicator		\$159 each			
H-2187	48" Tape Applicator		\$149 each			

Order 5+ rolls and pay only \$135 for H-3796 applicator.



PROTECTS FOR UP TO 45 DAYS

## GLASS

Protect windows, mirrors and high gloss surfaces from moving damage and paint oversprays.

SPECIFY COLOR: Blue or Clear

- Peels away from the surface. Eliminates scraping and scratching.
- Use indoors and outdoors.
- Poly film with light adhesive leaves no residue.

MODEL NO.	ROLL SIZE	MIL	LBS./ROLL	PRICE PER ROLL		
				1	2	4+
S-19222	3" x 200'	1.6	1	N/A	N/A	\$12
S-19223	6" x 200'		1	N/A	\$21	17
S-12924	10" x 200'		3	\$26	23	18
S-10513	12" x 200'		3	30	26	20
S-7588	24" x 200'		5	41	37	32
S-9779	36" x 200'	8	8	52	48	41
S-14523	48" x 200'		10	61	57	52



PROTECTS FOR UP TO 45 DAYS

## HARD SURFACE

Protect floors from damage during maintenance and painting.

- Safely covers hardwood, laminate, marble and tile surfaces.
- Blue-tinted poly film with medium tack adhesive backing.
- Removes easily. Leaves no residue.

MODEL NO.	ROLL SIZE	MIL	LBS./ROLL	PRICE PER ROLL		
				1	2	4+
S-19224	12" x 200'	3.0	4	\$50	\$44	\$39
S-12213	24" x 200'		7	64	57	50
S-13762	24" x 500'		16	126	113	103
S-12214	36" x 200'		11	75	68	61
S-13763	36" x 500'		25	153	146	137
S-14524	48" x 200'		14	95	88	79



PROTECTS FOR UP TO 45 DAYS

## COUNTERTOP

Protect marble, granite and laminate surfaces during construction and remodeling.

- Guards against scratches, abrasion and paint overspray.
- Removes easily, leaves no residue.

MODEL NO.	ROLL SIZE	MIL	LBS./ROLL	PRICE PER ROLL		
				1	2	4+
S-14527	24" x 200'	3.0	6	\$59	\$52	\$44
S-14528	36" x 200'		9	85	75	64



PROTECTS FOR UP TO 30 DAYS

# VELCRO® TAPE

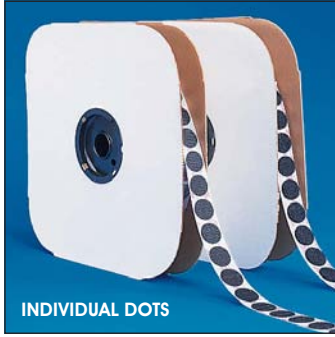

INDIVIDUAL DOTS



INDIVIDUAL STRIPS

Fasten and reattach products quickly and easily.

- Strong acrylic adhesive can be used outdoors.
- Hook and loop sold separately.

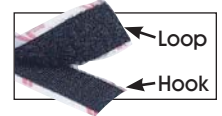

**Dots** – Hang, secure, organize items.

**Strips** – Recommended for putting up signs, holding tools and creating display boards.

## INDIVIDUAL DOTS

Hook and loop used in combination

SIZE	COLOR	MODEL NO./DESCRIPTION				PRICE EACH	
						1	3+
3/8" – 1800 ct.	Black	S-13655	Hook	S-13656	Loop	\$56	\$53
	White	S-13657	Hook	S-13658	Loop		
1/2" – 1440 ct.	Black	S-7846	Hook	S-7847	Loop	59	57
	White	S-7848	Hook	S-7849	Loop		
5/8" – 1200 ct.	Black	S-13659	Hook	S-13660	Loop	65	63
	White	S-13661	Hook	S-13662	Loop		
3/4" – 1028 ct.	Black	S-7850	Hook	S-7851	Loop	70	68
	White	S-10522	Hook	S-10523	Loop		
7/8" – 900 ct.	Black	S-7200	Hook	S-7201	Loop	71	69
	White	S-11700	Hook	S-11701	Loop		
1 3/8" – 600 ct.	Black	S-11702	Hook	S-11703	Loop	90	87
	White	S-11704	Hook	S-11705	Loop		
1 7/8" – 450 ct.	Black	S-17160	Hook	S-17161	Loop	102	98
	White	S-17162	Hook	S-17163	Loop		

## INDIVIDUAL STRIPS

Hook and loop used in combination

SIZE	COLOR	MODEL NO./DESCRIPTION				PRICE EACH	
						1	3+
1/2" x 75'	Black	S-13663	Hook	S-13664	Loop	\$29	\$26
	White	S-13665	Hook	S-13666	Loop		
5/8" x 75'	Black	S-11706	Hook	S-11707	Loop	37	33
	White	S-11708	Hook	S-11709	Loop		
3/4" x 75'	Black	S-7198	Hook	S-7199	Loop	42	39
	White	S-7861	Hook	S-7862	Loop		
1" x 75'	Black	S-11710	Hook	S-11711	Loop	48	45
	White	S-11712	Hook	S-11713	Loop		
1 1/2" x 75'	Black	S-17164	Hook	S-17165	Loop	72	67
	White	S-17166	Hook	S-17167	Loop		
2" x 75'	Black	S-11714	Hook	S-11715	Loop	86	81
	White	S-11716	Hook	S-11717	Loop		
4" x 75'	Black	S-13667	Hook	S-13668	Loop	152	139
	White	S-13669	Hook	S-13670	Loop		

# VELCRO® COMBO PACKS

Ideal for small-volume users. Contains both hook and loop.

**Industrial Strips** – Water resistant for indoor or outdoor use.



COMBO STRIPS



COMBO DOTS

## COMBO PACKS

SIZE	COLOR	MODEL NO./DESCRIPTION		PRICE EACH	
				1	3+
3/4" x 15'	Clear	S-17168	Strips	\$28	\$25
	Black	S-5750			
	White	S-6096			
2" x 15'	Black	S-5751	Industrial Strips	43	40
	White	S-6097			
3/4" – 200 ct.	Beige	S-6098	Dots	28	25
	Clear	S-17169			
	Black	S-17170			
	White	S-17171			



BULK COMBO STRIPS

## BULK COMBO PACKS

Full size rolls for large volume use.

- Contains 75 feet of hook and loop strips.

**High Strength** – 2x stronger than standard Velcro®.

## BULK COMBO PACKS

SPECIFY COLOR: Black or White

SIZE	COLOR	MODEL NO./DESCRIPTION		PRICE EACH	
				1	3+
1" x 75'	Specify	S-23101	Strips	\$110	\$100
		S-23102		193	183

## HIGH STRENGTH BULK COMBO PACKS

SPECIFY COLOR: Black or White

SIZE	COLOR	MODEL NO./DESCRIPTION		PRICE EACH	
				1	3+
1" x 75'	Specify	S-23646	High Strength Strips	\$145	\$135
		S-23647		250	240

# ULINE HOOK AND LOOP TAPE

Hang signs, secure drapery ends, mount display boards.

- Versatile. Dots or strips for different jobs.
- Hook and loop sold separately.
- Weather resistant.

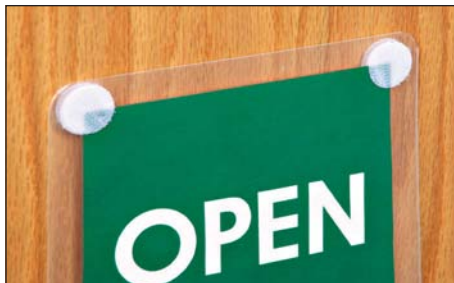

## INDIVIDUAL DOTS

Hook and loop used in combination

SIZE	COLOR	MODEL NO./DESCRIPTION		PRICE EACH	
				1	3+
3/8" - 1800 ct.	Black	S-13612 Hook	S-13613 Loop	\$36	\$34
	White	S-13614 Hook	S-13615 Loop		
1/2" - 1440 ct.	Black	S-12710 Hook	S-12711 Loop	41	39
	White	S-12712 Hook	S-12713 Loop		
5/8" - 1200 ct.	Black	S-14543 Hook	S-14544 Loop	47	45
	White	S-14545 Hook	S-14546 Loop		
3/4" - 1028 ct.	Black	S-12714 Hook	S-12715 Loop	51	48
	White	S-12716 Hook	S-12717 Loop		
7/8" - 900 ct.	Black	S-12718 Hook	S-12719 Loop	57	53
	White	S-12720 Hook	S-12721 Loop		
1 1/8" - 600 ct.	Black	S-14547 Hook	S-14548 Loop	72	68
	White	S-14549 Hook	S-14550 Loop		
1 1/2" - 450 ct.	Black	S-17136 Hook	S-17137 Loop	75	70
	White	S-17138 Hook	S-17139 Loop		

## INDIVIDUAL STRIPS

Hook and loop used in combination

SIZE	COLOR	MODEL NO./DESCRIPTION		PRICE EACH	
				1	3+
1/2" x 75'	Black	S-13616 Hook	S-13617 Loop	\$21	\$19
	White	S-13618 Hook	S-13619 Loop		
5/8" x 75'	Black	S-14551 Hook	S-14552 Loop	26	23
	White	S-14553 Hook	S-14554 Loop		
3/4" x 75'	Black	S-12722 Hook	S-12723 Loop	27	24
	White	S-12724 Hook	S-12725 Loop		
1" x 75'	Black	S-12726 Hook	S-12727 Loop	35	30
	White	S-12728 Hook	S-12729 Loop		
1 1/2" x 75'	Black	S-17140 Hook	S-17141 Loop	48	45
	White	S-17142 Hook	S-17143 Loop		
2" x 75'	Black	S-12730 Hook	S-12731 Loop	61	57
	White	S-12732 Hook	S-12733 Loop		
4" x 75'	Black	S-14555 Hook	S-14556 Loop	116	105
	White	S-14557 Hook	S-14558 Loop		

# ULINE HOOK AND LOOP COMBO PACKS

Convenient size for small jobs and low volume applications.

- Use in offices and maintenance departments.
- Includes both hook and loop.
- Strong adhesive backing.
- For indoor/outdoor use.
- Water resistant.

## PRECUT SQUARES AND STRIPS

Hook and loop pieces come attached for ease of use.

- Indoor or outdoor use.
- Weather resistant.



S-15761



S-15759

## COMBO PACKS

SIZE	COLOR	MODEL NO./DESCRIPTION		PRICE EACH	
				1	3+
1/2" - 200 sets	Black	S-17144	Dots	\$18	\$16
	White	S-17145			
3/4" - 200 sets	Black	S-15761	Dots	18	16
	White	S-15762			
1" x 15'	Black	S-15759	Strips	18	16
	White	S-15760			

## PRECUT SQUARES AND STRIPS

SIZE	COLOR	MODEL NO./DESCRIPTION		PRICE EACH	
				1	3+
1 x 1" - 200 sets	Black	S-17029	Squares	\$20	\$18
	White	S-19574			
1 x 3" - 200 sets	Black	S-17030	Strips	58	54
	White	S-19575			



# 3M DUAL LOCK™



## HEAVY DUTY

Fasten heavier items for a more permanent bond.

- Rigid plastic stems interlock.
- 75 ft. of usable product.
- 15 ft. of usable product – S-7202 and S-15826. 2 rolls per pack.



Rubber Adhesive – Use indoors up to 120°F.

Acrylic Adhesive – Outdoor use up to 200°F.

Low Profile – Flexible and invisible. For use up to 158°F.

## RUBBER ADHESIVE

MODEL NO.	DESCRIPTION	COLOR	SIZE	STEMS/INCH	PRICE EACH	
					1	2+
S-15824	3M SJ3542	Black	1" x 150'	170	\$406	\$383
S-14563	3M SJ3540	Black	1/2" x 150'	250	281	267
S-15908			3/4" x 150'		344	322
S-6762			1" x 150'		406	383
S-11739			2" x 150'		797	750
S-15825	3M SJ3541	Black	1" x 150'	400	407	384
S-15826	3M MP3541/42		1" x 15'	400/170	145	133

## ACRYLIC ADHESIVE

MODEL NO.	DESCRIPTION	COLOR	SIZE	STEMS/INCH	PRICE EACH	
					1	2+
S-23937	3M SJ3560	Clear	1/2" x 150'	250	\$325	\$308
S-11738	3M SJ3560		1" x 150'		655	614
S-7202	3M MP3560		1" x 15'		222	211

## LOW PROFILE ACRYLIC ADHESIVE

MODEL NO.	DESCRIPTION	COLOR	SIZE	STEMS/INCH	PRICE EACH	
					1	2+
S-17428	3M SJ4570	Clear	5/8" x 150'	705	\$154	\$145
S-23936			3/4" x 150'		171	161
S-17429			1" x 150'		225	214

# ULINE SEW-ON HOOK AND LOOP



## WASHABLE

Secure drapery liners, clothing, decorative furnishings.

- Gives fabrics and garments a tailored, custom look.
- Nylon. Sew on by hand or machine.

Hook and loop used in combination

SIZE	COLOR	MODEL NO./DESCRIPTION		PRICE EACH	
				1	3+
3/4" x 75'	Black	S-13620 Hook	S-13621 Loop	\$14	\$13
	White	S-13622 Hook	S-13623 Loop		
1" x 75'	Black	S-13624 Hook	S-13625 Loop	17	16
	White	S-13626 Hook	S-13627 Loop		
2" x 75'	Black	S-14559 Hook	S-14560 Loop	30	28
	White	S-14561 Hook	S-14562 Loop		
4" x 75'	Black	S-19442 Hook	S-19443 Loop	62	58

# GORILLA ADHESIVES

**Duct Tape** – Thick black 17 mil extreme grip for wood, stucco, brick and other rough surfaces.

**Repair Tape** – Crystal clear. Fix, patch and seal everything from tarps to leather seats.

**Glue** – 100% waterproof. Bonds wood, stone, metal, fiberglass and more.

**Super Glue** – Dries in 15-30 seconds. Bonds just about everything.

## DUCT TAPE – 17 MIL

\* SPECIFY COLOR: Black or Silver

MODEL NO.	SIZE	PRICE EACH		
		1	4	8+
S-13786*	2" x 30 yds.	\$15	\$14	\$13
S-19755	3" x 25 yds.	21	20	19

## CLEAR REPAIR TAPE – 7 MIL

MODEL NO.	SIZE	PRICE EACH
S-22087	2" x 27 ft.	N/A \$10 \$9

## GLUE

MODEL NO.	SIZE	PRICE EACH
S-13783	8 oz.	\$20 \$19 \$18
S-13784	18 oz.	29 28 27
S-13785	36 oz.	43 42 41

## SUPER GLUE

MODEL NO.	SIZE	PRICE EACH
S-17186	.5 oz.	N/A \$8 \$7
S-17187	16 oz.	\$175 170 165

The toughest adhesive on the planet!



# SELF-GRIP STRAPS

## ULINE

Wraps around anything and sticks to itself for fast, easy bundling.

- Reusable. Bundle cords, cable, wire, pipe and tubing.
- Hook on one side, loop on back.



MODEL NO.	DESCRIPTION	COLOR	SIZE	PRICE PER ROLL	
				1	3+
S-15756	ULINE Self-Grip Straps	Black	1/2" x 75'	\$20	\$17
S-15757			3/4" x 75'	29	25
S-15758			1" x 75'	39	35

## VELCRO®

Bundle wires and cords in one easy step.

- Hook on one side, loop on the other attaches back to itself for a secure closure.



\* SPECIFY COLOR: Black, Red, White or Orange

MODEL NO.	DESCRIPTION	COLOR	SIZE	PRICE PER ROLL	
				1	3+
S-13671*	VELCRO® Self-Grip Straps	Specify	1/2" x 75'	\$34	\$31
S-8136*			3/4" x 75'	38	35
S-13672*			1" x 75'	51	49
S-14449		Black	1 1/2" x 75'	65	61
S-14450			2" x 75'	80	75

## VELCRO® PERFORATED STRAPS

MODEL NO.	DESCRIPTION	COLOR	SIZE	STRAPS/ROLL	PRICE PER ROLL	
					1	3+
S-23591	Perforated Straps	Black	1/2 x 6"	150	\$42	\$37
S-23592			3/4 x 6"		52	47

Recommended for IT techs and electricians.

- Perforated every 6 inches to tear easily without scissors.



## VELCRO® CABLE TIES

MODEL NO.	DESCRIPTION	COLOR	SIZE	STRAPS/ROLL	PRICE PER ROLL		
					1	5+	
S-19436	Cable Ties	Black	1/2 x 8"	100	\$39	\$35	
S-17101			3/4 x 6"		32	28	
S-17102			3/4 x 8"		45	40	
S-17898			3/4 x 12"		50	32	28
S-19437			3/4 x 18"		25	29	25

Recommended for wires and cables.

- Pull narrow end through slotted end and cinch up tight.



## VELCRO® CINCH STRAPS

MODEL NO.	DESCRIPTION	COLOR	SIZE	STRAPS/BAG	PRICE PER BAG		
					1	3+	
S-17894	Cinch Straps	Black	1 x 12"	25	\$29	\$27	
S-17895			1 x 18"		36	34	
S-19446			2 x 18"		10	30	28
S-19447			2 x 36"		10	35	33

Provide extra holding power with hook and loop cinch straps.

- Bundle and hold hoses, tubes or extension cords.
- Adjustable and reusable.



## JUMBO VELCRO® STRAPS

Temporarily secure your pallet loads for internal transfers.

- Straps attach and release quickly, no tools required.
- Reusable 2" wide strap leaves barcodes visible.

Heavy Duty – 2x the break strength of standard straps. Secures bulky transfers and heavy loads.



### STANDARD

MODEL NO.	SIZE	BREAK STRENGTH	COLOR	PRICE EACH (MIN. 2)		
				2	4	8+
S-18396	2" x 16'	225 lbs.	Orange	\$15	\$14	\$13
S-18397	2" x 23'		Blue	18	17	16

### HEAVY DUTY

MODEL NO.	SIZE	BREAK STRENGTH	COLOR	PRICE EACH		
				1	3	5+
S-23594	2" x 16'	500 lbs.	Black	\$44	\$41	\$39
S-23595	2" x 23'			61	58	56

# KAPTON® TAPE



Max. Temp. 500°F

Maximum resistance to high temperatures.

- Recommended for masking circuit boards and splicing wires.
- Polyimide film with silicone adhesive for easy release.
- UL 510 flame retardant.

MODEL NO.	SIZE	FILM THICKNESS	TOTAL THICKNESS	PRICE PER ROLL (*MIN. 2)		
				1-2	4	8+
S-10518*	1/4" x 36 yds.	1 mil	2.5 mil	\$12	\$11	\$10
S-11729	3/8" x 36 yds.			16	15	14
S-7595	1/2" x 36 yds.			20	19	18
S-7596	3/4" x 36 yds.			30	29	28
S-11730	1" x 36 yds.			40	38	36
S-17210	1 1/4" x 36 yds.			53	50	47
S-17211	1 1/2" x 36 yds.			59	56	53
S-11731	2" x 36 yds.			77	74	71
S-14533	3" x 36 yds.			110	105	100
S-17212	1/2" x 36 yds.			2 mil	3.5 mil	35
S-17213	3/4" x 36 yds.	49	47			44
S-17214	1" x 36 yds.	65	61			57
S-17215	2" x 36 yds.	130	120			110
S-23596	1/2" x 36 yds.	5 mil	6.5 mil			90
S-23597	1" x 36 yds.			180	175	165

# FIBERGLASS TAPE



Max. Temp. 500°F

COATED WITH TEFLON® PTFE

Protect your poly bag and shrink wrap equipment.

- Acts as a protective barrier to hot wire contacts.
- Silicone adhesive. 3" core.
- 10 mil – Thicker tape withstands heat twice as long. Acrylic adhesive.

MODEL NO.	SIZE	FILM THICKNESS	TOTAL THICKNESS	PRICE PER ROLL		
				1	2	3+
S-17216	1/4" x 18 yds.	3 mil	5 mil	\$20	\$19	\$18
S-5331	3/8" x 36 yds.			40	37	35
S-10514	1/2" x 36 yds.			45	41	38
S-10515	3/4" x 36 yds.			49	46	43
S-7196	1" x 18 yds.			35	32	30
S-17217	1 1/2" x 18 yds.			47	44	41
S-7197	2" x 18 yds.			58	55	52
S-13673	3" x 18 yds.			83	78	73
S-17218	4" x 18 yds.			115	110	100
S-17219	1" x 18 yds.			5 mil	7 mil	46
S-17220	2" x 18 yds.	91	85			80
S-14529	1/2" x 36 yds.	10 mil	12 mil	57	54	50
S-14530	3/4" x 36 yds.			80	76	73
S-11728	1" x 18 yds.			57	54	50
S-14531	2" x 18 yds.			110	105	100

# GREEN PET TAPE

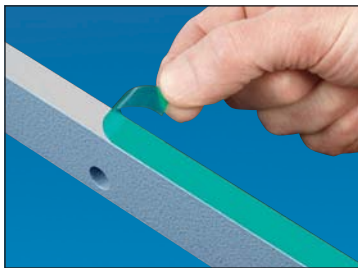

High temperature masking tape for powder coat painting and electroplating.

- Polyester film with silicone adhesive.
- No residue, easy removal.
- Temperature range up to 400°F.

MODEL NO.	SIZE	FILM THICKNESS	TOTAL THICKNESS	PRICE PER ROLL (*MIN. 2)		
				1-2	4	8+
S-10516*	1/2" x 72 yds.	2 mil	3.5 mil	\$8	\$7	\$6
S-10517	1" x 72 yds.			15	13	12
S-19435	2" x 72 yds.			30	26	24
S-22231	3" x 72 yds.			45	39	36

# ALUMINUM FOIL TAPE



Versatile heat-shielding tape to seal ducts.

- Waterproof, linerless tape.
- Deflects heat to prevent damage to parts.
- 3M tape is UL Listed.

## ULINE

MODEL NO.	SIZE	MIL	ROLLS/ CASE	PRICE PER ROLL	
				1	6+
S-15778	1" x 60 yds.	5.5	36	\$31	\$30
S-7166	2" x 60 yds.		24	50	48
S-15779	3" x 60 yds.		16	81	77

## 3M 425

S-10308	1/2" x 60 yds.	4.6	72	\$33	\$32
S-10309	3/4" x 60 yds.		48	40	39
S-10310	1" x 60 yds.		36	51	49
S-10311	2" x 60 yds.		24	101	97
S-14665	3" x 60 yds.		12	156	146



## ULINE GLUE GUNS/STICKS



**H-1078 Light Duty**

For small projects and repairs.

- Heats up to 375°F in 3 minutes.



**H-9304 Industrial**

Heavy duty, large volume.

- Heats up to 380°F in 3 minutes.



**H-3129 High Performance**

35% more output. Chubby 5/8" sticks.

- Heats up to 450°F in 3 minutes.



**H-1903 Heavy Duty**

High-volume projects.

Heats up to 450°F in 3 minutes.

### GLUE STICKS

MODEL NO.	SIZE	DESCRIPTION	COLOR	RECOMMENDED FOR	QTY./CTN.	PRICE PER CARTON		
						1	2	3+
S-13693	1/2 x 15"	Economy	Clear	Gen. Purpose Crafts	300	\$179	\$173	\$164
S-13694		Industrial	Amber	Carton Sealing	300	<b>\$154 per ctn. any qty.</b>		
S-509	1/2 x 15"	Heavy Duty	Amber	Hard-to-Bond Projects, Carton Sealing	50	59	54	51
S-3966					300	<b>\$215 per ctn. any qty.</b>		
S-17896*	5/8 x 10"	Industrial	Amber	Wood Assembly	265	173	169	163

\* Use with H-3129 Gun

### GLUE GUNS

MODEL NO.	USES STICKS	DESCRIPTION	WATTS	TEMP. RANGE	OUTPUT LBS./HOUR	PRICE EACH		
						1	2	3+
H-1078	1/2"	Light Duty	80	375°F	2-4	\$30	\$27	\$25
H-9304	1/2"	Industrial	180	380°F	4-6	75	69	62
H-1903	1/2"	Heavy Duty	300	250-450°F	5-8	119	108	98
H-3129	5/8"	High Performance	450	280-450°F	9-11	161	150	140

Lay down fast, precise beads of hot glue for sealing and assembly.

**SPECIAL OFFER!**  
Order 3 cartons of Glue Sticks and pay only \$80 for H-1903 Glue Gun.

## ULINE MOTORIZED GLUE GUN

Power and speed for repetitive high-volume assembly line packaging.

- Extra long 5/8 x 15" chubby sticks. Produces continuous glue flow.
- Features rubber trigger grip and built-in stand.
- Includes heavy-duty carrying case. • Heats up to 400°F in 10 minutes.

### GLUE STICKS

MODEL NO.	SIZE	DESCRIPTION	COLOR	RECOMMENDED FOR	QTY./CTN.	PRICE PER CARTON		
						1	2	3+
S-22333	5/8 x 15"	Industrial	Amber	High-Volume Packaging	175	\$175	\$170	\$165

### GLUE GUN

MODEL NO.	USES STICKS	DESCRIPTION	WATTS	TEMP. RANGE	OUTPUT LBS./HOUR	PRICE EACH		
						1	2	3+
H-7182	5/8"	Motorized High Output	500	400°F	8.4	\$440	\$425	\$415



**SPECIAL OFFER!**  
Order 3 cartons of Glue Sticks and pay only \$348 for H-7182 Glue Gun.

## 3M GLUE GUN/STICKS

Permanent hot melt adhesive for carton sealing and product assembly.

- Rugged, compact and lightweight. • Heats up to 400°F in 3 minutes.

### GLUE STICKS

MODEL NO.	SIZE	DESCRIPTION	COLOR	RECOMMENDED FOR	QTY./CTN.	PRICE PER CARTON		
						1	2	3+
S-16107	1/2 x 12"	3762 AE	Amber	Carton Sealing	125	\$222	\$212	\$206
S-16108		3792 AE	Clear			Wood, Fabric	228	222

### GLUE GUN

MODEL NO.	USES STICKS	DESCRIPTION	WATTS	TEMP. RANGE	OUTPUT LBS./HOUR	PRICE EACH		
						1	2	3+
H-2609	1/2"	3M AE II	100	400°F	4	\$154	\$145	\$140



# HI-VIS TARPS



Super bright tarps can't be missed on busy job sites.

- Recommended for construction zones, warehouses and outdoor storage areas.
- Super thick, UV-treated poly with rope reinforced hems. Both sides laminated. Plastic reinforced corners.
- Hi-vis lime on one side, orange on the other.

Grommets 18" apart

MODEL NO.	DESC.	SIZE W x L	MIL	LBS. EACH	PRICE EACH			
					1	2	4	10+
S-24683		16 x 20'		15	\$75	\$70	\$65	\$60
S-24684	Hi-Vis	20 x 30'	12	29	130	125	120	115
S-24685		40 x 60'		112	425	415	405	395

# KNAACK JOBSITE BOX

IN STOCK – SHIPS TODAY

The absolute best security for your tools and precious equipment.

- Built to last! All welded, 16-gauge steel with heavy-duty hinges.
- Recessed 3-point locking system resists prying and theft.
- 4-way forkliftable. Power cord access for charging tools.



MODEL NO.	DESCRIPTION	SIZE W x D x H	CAPACITY (CU. FT.)	WT. (LBS.)	PRICE EACH	
					1	2+
H-10011	Knaack Jobsite Box	48 x 24 x 29"	16	157	\$975	\$950

For Padlocks, see pages 514-515

SHIPS VIA MOTOR FREIGHT



# BARRICADE TAPE

NO ADHESIVE

- Reusable – Re-roll and store in dispenser box for later use.
- 2" letters are easy to read. • Weather-resistant poly.

SIZE	MODEL NO. / MESSAGE				MIL	ROLLS/ CASE	PRICE PER ROLL	
							2	8+
3" x 1,000'	S-2744	"Caution"	S-2746	"Danger"	3	8	\$19	\$18
	S-2745	"Caution Do Not Enter"	S-7863	Blank Yellow				
	S-14695	Blank Red	S-14696	Blank Orange				
	S-17224	Black/Yellow Striped	S-17867	"Caution/Cuidado"				

MIN. 2 ROLLS



# FLAGGING TAPE

NO ADHESIVE

Survey and mark boundaries, trees and hazardous areas with this high visibility tape.

- Standard colors are 300' in length. • Fluorescent colors are 150' in length.

SIZE	MODEL NO. / COLOR				MIL	ROLLS/ CASE	PRICE PER ROLL	
							12	24+
1 1/8" x 300'	S-6089BLU	Blue	S-6089Y	Yellow	2.1	12	\$2.20	\$2.10
	S-6089R	Red	S-6089W	White				
	S-6089PUR	Purple	S-6089BL	Black				
1 3/16" x 150'	S-6089FG	Fluor. Green	S-6089FP	Fluor. Pink	4.2	12	2.20	2.10
	S-6089FO	Fluor. Orange	S-6089FY	Fluor. Yellow				

SOLD IN CASE QUANTITIES

Tears and ties easily by hand.

# SAFETY MESSAGE MATS

Walk into the warehouse with safety on your mind.



H-10006



H-10007

- Recommended for loading docks and maintenance areas.
- Non-skid rubber backing. Long-lasting polyester fibers retain their shape.



H-10005

MODEL NO.	DESCRIPTION	SIZE	THICKNESS	PRICE EACH		
				1	3	6+
H-10005	"Caution Forklift Traffic"	3 x 5'	5/16"	\$160	\$153	\$145
H-10006	"Watch Your Step"					
H-10007	"Slippery When Wet"					

Complete line of Floor Mats, see pages 317-331.

## ANTI-SLIP TREADS



S-19961



S-24730



S-9778

Prevents slips, trips and falls with abrasive pre-cut strips.

- Sandpaper-like grit surface with adhesive back.
- Grease and water resistant.
- Indoor/outdoor use.



S-19962

MODEL NO.	DESCRIPTION	MIL	SIZE	STRIPS/CASE	PRICE PER CASE	
					1	4+
S-24729	Black	27	3/4 x 24"	50	\$65	\$60
S-24730	Gray		6 x 24"	50	119	109
S-9778	Black					
S-23685	Yellow/Black					
S-19961	"Caution"		6 x 24"	24	130	120
S-19962	"Watch Your Step"					

## ANTI-SLIP STAIR TREADS

Provide safe, sure footing on oil rig, factory and warehouse stairs.

- Heavy-duty grit prevents slips and falls in extreme conditions.
- Reinforced fiberglass is weather, chemical and rust resistant.

MODEL NO.	DESCRIPTION	SIZE	THICKNESS	PRICE EACH	
				1	5+
H-10008	Black/Yellow	36 x 9"	1/8"	\$110	\$105
H-10009		48 x 9"		140	130

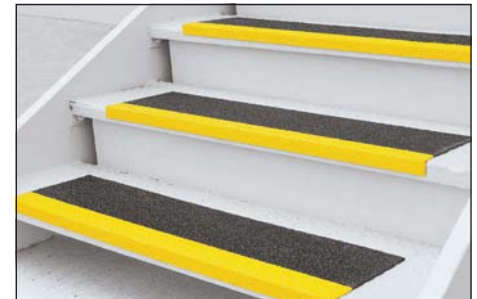
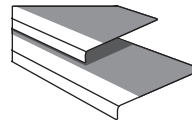

Easy install with Construction Adhesive, see [uline.com](http://uline.com)

## RUST-OLEUM® 5600 FLOOR PAINT

Refresh and protect warehouse floors. Mark boundaries and walkways.

- Impressive gloss finish and durability with premium acrylic urethane.
- Low odor, mildew resistant. • One gallon covers 270 sq. ft.
- Easy brush, spray or roller application. Dries in 24 hours.



INDOOR/OUTDOOR

SPECIFY COLOR: Yellow Gray Red White

MODEL NO.	DESCRIPTION	SIZE	WT. (LBS.)	QTY./CTN.	PRICE PER CAN		
					2	4	6+
S-22334	Acrylic Floor Paint	1 Gallon	10	2	\$76	\$74	\$72

SOLD IN CARTON QUANTITIES



Anti-Slip Paint Additive available, see [uline.com](http://uline.com)



# ULINE ANTI-SLIP TAPE



Help prevent injuries from slipping and falling.

- Grit sandpaper surface with adhesive back.
- Grease and water resistant.
- Temperature range -20° to 150°F.

**Heavy Duty** – Thicker, extra-coarse surface with aggressive adhesive. For muddy, greasy and oily areas.

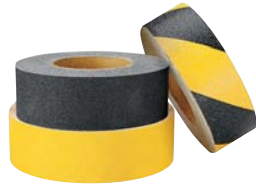

**"Caution Watch Your Step"** – Warn of slip and trip hazards. Use on stairs, ramps, walkways and uneven floors.



**Extra Wide** – Ideal for ramps and walkways. Up to 4' wide.



**Waterproof** – Stay safe walking on slippery tile or wet warehouse floors.



- Nonabrasive, textured PVC surface with strong adhesive backing.
- Temperature range -20° to 220°F.

**Anti-Slip Sheets** – Provide sure footing on ramps, walkways and wash-down areas.



- Fiberglass-reinforced plastic.
- Recommended for outdoor use.
- Install with construction adhesive or fasteners.

MODEL NO.	ROLL SIZE	MIL	COLOR	PRICE PER ROLL		
				1	3	6+
S-14681	1" x 60'	22	Black	\$22	\$21	\$19
S-7187	2" x 60'			39	37	35
S-19956	3" x 60'			55	53	51
S-7188	4" x 60'			69	67	65
S-14682	6" x 60'			104	101	97
S-23011	8" x 60'			140	135	130
S-17180	12" x 60'			207	201	195
S-21290	18" x 60'			243	235	227
S-19021	24" x 60'			280	270	260
S-13765	2" x 60'	27	Yellow	42	40	38
S-23012	3" x 60'			64	62	60
S-13767	4" x 60'			75	73	71
S-17181	6" x 60'			113	110	107
S-13764	2" x 60'	27	Yellow/Black	42	40	38
S-19957	3" x 60'			64	62	60
S-13766	4" x 60'			75	73	71
S-15798	6" x 60'			110	108	105
S-24768	2" x 60'	27	Gray	42	40	38
S-24769	4" x 60'			75	73	71
S-15799	2" x 60'	27	Clear	46	44	42
S-23626	4" x 60'			75	73	71
S-19023	2" x 60'	27	White	42	40	38
S-23627	3" x 60'			64	62	60

## HEAVY DUTY

S-21292	2" x 60'	35	Black	\$44	\$42	\$40
S-21293	4" x 60'			79	76	73
S-21294	6" x 60'			117	113	110
S-21295	12" x 60'			225	217	210
S-22260	24" x 60'			320	312	305
S-24770	2" x 60'	35	Yellow	47	45	43
S-24771	4" x 60'			85	82	78
S-23013	2" x 60'	35	Yellow/Black	47	45	43
S-22261	4" x 60'			85	82	78
S-22262	6" x 60'			124	119	115
S-23014	12" x 60'			235	227	220

## "CAUTION WATCH YOUR STEP"

S-23629	3" x 60'	34	Yellow	\$64	\$62	\$60
---------	----------	----	--------	------	------	------

## EXTRA WIDE

S-21291	36" x 60'	22	Black	\$427	\$412	\$397
S-23195	48" x 60'			550	525	500
S-23630	36" x 60'	35	Black	490	475	460

## WATERPROOF

SPECIFY COLOR: Black or Gray

S-24748	1" x 60'	22	Specify	\$22	\$21	\$19
S-24749	2" x 60'			39	37	35
S-24750	4" x 60'			69	67	65
S-24751	6" x 60'			104	101	97

## SAFESTEP® ANTI-SLIP SHEETS

SPECIFY COLOR: Yellow or Black

S-23727	47 x 47"	125	Specify	\$345	\$335	\$325
---------	----------	-----	---------	-------	-------	-------

# WAREHOUSE FLOOR SIGNS

Big, bold warning signs alert and inform employees from the ground up.

- Use on high-traffic walkways, stairways and doorways. Easy peel-and-stick acrylic adhesive stays put.
- Durable overlaminated vinyl with anti-slip surface.



S-22283



S-22284



S-20848



S-23150



S-19292



S-23153



S-23678



S-23679



S-23680



S-23681



S-23151



S-20847



S-24194



S-24196



S-19293



S-22282



S-23682



S-23152



S-19291



S-23683



S-23684

## SHAPES



S-24126



S-22285



S-20846

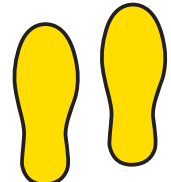

S-22286

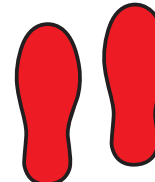

S-24192

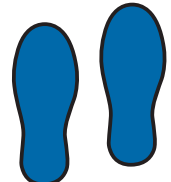

S-24193

## SIGNS

MODEL NO.	SIZE (DIAM.)	PRICE EACH		
		1	3	5+
S-19290 to S-24196	17"	\$28	\$26	\$24

## SHAPES

MODEL NO.	SIZE W x L	PAIRS/PACK	PRICE PER PACK		
			1	3	5+
S-22286 to S-24193	3½ x 9"	5	\$25	\$23	\$21

# REFLECTIVE TAPE

MIN. 2 ROLLS

SIZE	MODEL NO. / COLOR		MIL	ROLLS/ CASE	PRICE PER ROLL		
					2	6	1+ CS.
1" x 10 yds.	S-15789 White	S-15790 Yellow	5.5	48	\$9	\$8	\$7
	S-19004 Orange	S-17173 Red					
	S-17174 Red/White	S-17175 Black/Yellow			13	12	11
2" x 10 yds.	S-6730 White	S-6731 Yellow	5.5	24	19	17	15
	S-12905 Blue	S-6729 Red					
	S-12906 Green	S-14685 Orange					
	S-18174 Black				27	25	23
	S-6732 Red/White	S-13602 White/Orange					
	S-6733 Black/Yellow	S-14686 Black/White					
3" x 10 yds.	S-15791 White	S-15792 Yellow	5.5	16	29	26	24
	S-17176 Blue	S-17177 Red					
	S-19005 Green	S-18176 Black			40	37	36
	S-15793 Red/White	S-15794 Black/Yellow					
4" x 10 yds.	S-19006 White	S-19007 Yellow	5.5	12	38	35	32
	S-17178 Red/White	S-17179 Black/Yellow			53	49	45
6" x 10 yds.	S-19448 Yellow		5.5	8	57	51	47
	S-19449 Red/White	S-19450 Black/Yellow			80	74	70



Reduce accidental damage to poles, dock doors and racking.

- Lasts up to 7 years.
- Outstanding in low light or dark areas.

# OUTDOOR REFLECTIVE TAPE

7 times brighter than standard reflective tape.



- For rugged outdoor use on equipment, loading docks and barricades.
- Weather, impact, abrasion and solvent resistant.
- Lasts up to 5 years.

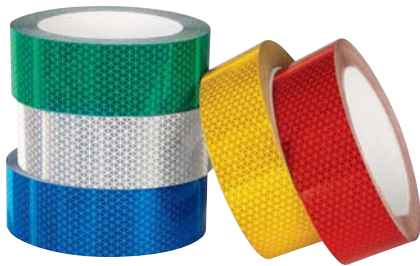

High-tack pressure sensitive acrylic adhesive

SIZE	MODEL NO.	COLOR	MIL	ROLLS/ CASE	PRICE PER ROLL		
					1	6	10+
1" x 50'	S-22329	Specify Color: White, Red, Yellow, Blue, Green or Orange	6.5	10	\$30	\$28	\$26
2" x 50'	S-22330				60	56	52
3" x 50'	S-23631			7	90	84	78
4" x 50'	S-23632			5	121	112	104
6" x 50'	S-24328			5	181	168	156

# DELUXE SAFETY TAPE

Continued from page 823

MIGHTY LINE®



SHAPES



FOOTPRINTS

Shapes – Mark lanes, divide pallet locations or outline equipment.

Footprints – Safely mark pedestrian walkways.

Label Protectors – Cover and extend the life of barcodes and floor signs.

Clear – Cover and extend the life of floor markings and painted lines.

SHAPES SPECIFY COLOR: Yellow, Blue, Green, White or Red

MODEL NO.	SIZE	COLOR	MIL	QTY./ BOX	PRICE PER BOX	
					1	2+
S-23655	6 x 6 x 2" T	Specify	45	24	\$36	\$32
S-23656	3 1/2" O				60	55
S-23870	5 1/2" U				95	90

FOOTPRINTS SPECIFY COLOR: Yellow, Blue, Green, White or Red

S-23755	3 3/8 x 9 1/4" U	Specify	45	50	\$130	\$120
---------	------------------	---------	----	----	-------	-------

LABEL PROTECTORS

S-24752	4 x 6"	Clear	50	50	\$65	\$60
S-23657	6 x 10"			50	150	145
S-24753	10 x 13"			24	160	155

CLEAR

MODEL NO.	SIZE	COLOR	MIL	LBS./ ROLL	PRICE PER ROLL	
					1	2+
S-23649	2" x 100'	Clear	50	5	\$165	\$155
S-23650	3" x 100'			8	175	165
S-23651	4" x 100'			10	185	175



LABEL PROTECTORS



# DELUXE SAFETY TAPE

MIGHTY LINE®



Guaranteed to withstand your roughest warehouse traffic.

- Beveled edges prevent tearing by forklift trucks or floor scrubbers.
- Easier to apply than paint.
- Heavy-duty PVC tape. Sticks tight, removes cleanly.

**Angles** – Precut corners indicate pallet location.

**Specialty** – Center stripe identifies walkways or pathways for AGVs.



**Glow** – Center stripe glows for 12 hours during power outages.

**Freezer** – Sticks tight when applied in temperatures down to -20°F.

**Traction** – Keep your guys on their feet. Diamond tread prevents slips.

**Reflective** – Center stripe reflects in the dark for late night drop-offs at the loading dock.

## TAPE APPLICATOR

**SPECIAL OFFER:  
SAVE \$100**

Order 3+ rolls of Deluxe Safety Tape and pay only \$300 for H-8719 applicator.



### TAPE SPECIFY COLOR: Yellow, Yellow/Blk, Blue, Green, White, Red, Red/White, Black/White, Black, Orange, Brown, Pink or Lime

MODEL NO.	SIZE	COLOR	MIL	LBS./ROLL	PRICE PER ROLL	
					1	2+
S-19801	2" x 100'	Specify	60	9	\$137	\$127
S-21259	3" x 100'				153	143
S-19125	4" x 100'				169	159
S-24725	6" x 100'	Yellow or Yellow/Blk	60	14	288	278

### ANGLES SPECIFY COLOR: Yellow, Yellow/Blk, Blue, Green, White, Red, Red/White, Black/White, Black, Orange or Lime

MODEL NO.	SIZE	COLOR	MIL	QTY./BOX	PRICE PER BOX	
					1	2+
S-19126	6 x 6 x 2"	Specify	45	24	\$36	\$32

### SPECIALTY SPECIFY COLOR: Yellow/Black or Orange/Blue

MODEL NO.	SIZE	COLOR	MIL	LBS./ROLL	PRICE PER ROLL	
					1	2+
S-22293	2" x 100'	Specify	60	6	\$165	\$155
S-22294	4" x 100'				185	175

### GLow

S-22295	2" x 100'	Yellow/Glow	60	6	\$165	\$155
S-22296	4" x 100'				185	175

### FREEZER SPECIFY COLOR: Yellow or Red

MODEL NO.	SIZE	COLOR	MIL	LBS./ROLL	PRICE PER ROLL	
					1	2+
S-23652	2" x 100'	Specify	50	9	\$170	\$160
S-23653	3" x 100'				185	175
S-23654	4" x 100'				200	190

### TRACTION SPECIFY COLOR: Yellow or Yellow/Black

S-24489	2" x 100'	Specify	50	6	\$150	\$140
S-24490	3" x 100'				165	155
S-24491	4" x 100'				180	170

### REFLECTIVE

S-24726	2 x 75'	Yellow/Reflective	60	7	\$155	\$145
S-24727	4 x 75'				175	165



MODEL NO.	HOLDS WIDTHS	PRICE EACH	
		1	2+
H-8719	2-4"	\$400	\$375

# 3M VINYL TAPE



"Do-it-all tape" color codes, masks, seals, splices and marks hazardous or restricted areas.

- Conforms to curved and irregular surfaces.
- Maintains color even with heavy abrasion.
- Aggressive adhesive. Residue-free removal.



## 3M 471

OSHA Safety Color Compliant

SIZE	MODEL NO.	COLOR	MIL	ROLLS/CASE	PRICE PER ROLL (MIN. 3)			
					3	6	12	24+
1/4" x 36 yds.*	S-10250	Specify Color: White, Red, Yellow, Blue, Orange, Green, Black or Clear	5.2	6	N/A	\$13	\$12	\$11
1/2" x 36 yds.	S-10251			72	\$21	20	19	18
3/4" x 36 yds.	S-10252			48	24	23	22	21
1" x 36 yds.	S-10253		5.2	36	27	26	24	23
2" x 36 yds.	S-10254			24	49	48	47	44
3" x 36 yds.▲	S-10255			12	73	72	71	70

\* Not available in Clear. ▲ Not available in Orange.

## 3M 5702

SIZE	MODEL NO.	COLOR	MIL	ROLLS/CASE	PRICE PER ROLL	PRICE PER ROLL	PRICE PER ROLL	PRICE PER ROLL
2" x 36 yds.	S-16012	Yellow/Black	5.4	24	\$73	\$72	\$71	\$70
3" x 36 yds.	S-16013			12	109	108	107	105

# ULINE VINYL MESSAGE TAPE

ADHESIVE

Easily mark off walls, floors or stairs in hazardous areas. For indoor use.

- Heavy-duty PVC tape with acrylic adhesive.



SIZE	MODEL NO. / MESSAGE	MIL	ROLLS/CASE	PRICE/ROLL	
				1	3+
3" x 60'	S-14687 "Caution" S-15781 "Restricted Area" S-15780 "Danger" S-15782 "Caution Do Not Enter"	5	20	\$21	\$20

# SAFETY CROWD CONTROL



TWO-TONE CHAIN

Two-tone chain and caution posts really drive home safety.

- Recommended for loading docks and entryways.
- Fill base with sand or gravel. Fill weight: 6.4 lbs.
- Plastic Chain – Easy to cut to size.

MODEL NO.	DESCRIPTION	HT.	POST DIAM.	BASE DIAM.	WT. (LBS.)	PRICE EACH	
						1	5+
H-8670	Yellow Post with Flat Base	40"	2 1/2"	14"	3	\$60	\$55
H-8671	Black/Yellow 100' Box of Chain – 2" Links				7	95	90

# RUBBER CORNER GUARD

Protect your walls and your customers' cars.

- Recommended for parking garages and warehouses.
- Heavy duty, high-impact 1/4" thick molded rubber.
- Yellow reflective stripes increase visibility.
- Securely installs with 6 lag bolts.



THICK MOLDED RUBBER

Hardware not included

MODEL NO.	SIZE L x W x D	PRICE EACH (MIN. 2)		
		2	10	20+
H-5175	32 x 4 x 4"	\$31	\$30	\$29

# ULINE VINYL SAFETY TAPE



## ULINE INDUSTRIAL TAPE – Unlaminated, general purpose.

SIZE	MODEL NO. / COLOR		MIL	ROLLS/ CASE	PRICE PER ROLL (MIN. 3)					
					3	6	12	24+		
1" x 36 yds.	S-7193	White	S-7189	Red	6	48	\$4.20	\$3.90	\$3.40	\$3.10
	S-7190	Yellow	S-7192	Blue						
	S-16861	Orange	S-7191	Green						
	S-16859	Purple	S-16860	Black						
	S-11641	Yellow/Black	S-16872	Red/White						
	S-16862	White/Black	S-16876	Green/White						
2" x 36 yds.	S-2230	White	S-385	Red	6	24	6.80	\$4.50 per roll		
	S-386	Yellow	S-7194	Blue						
	S-9665	Orange	S-7195	Green						
	S-13511	Purple	S-9732	Black						
	S-2183	Yellow/Black	S-16873	Red/White						
	S-13512	White/Black	S-16877	Green/White						
3" x 36 yds.	S-3359	White	S-3358	Red	6	16	12.10	11.50	9.60	8.30
	S-659	Yellow	S-11643	Blue						
	S-11644	Orange	S-9733	Green						
	S-13513	Purple	S-11642	Black						
	S-2184	Yellow/Black	S-16874	Red/White						
	S-13514	White/Black	S-16878	Green/White						
4" x 36 yds.	S-16863	White	S-7204	Red	6	12	16.60	15.50	13.20	10.40
	S-3054	Yellow	S-11646	Blue						
	S-16866	Orange	S-16865	Green						
	S-16867	Purple	S-16864	Black						
	S-11645	Yellow/Black	S-16875	Red/White						
	S-16868	White/Black	S-16879	Green/White						

## OSHA SAFETY COLOR CODES

**CAUTION** – Yellow/Black, Yellow  
Physical hazards, poles, stairs  
and corners.

**DANGER** – Red/White, Red  
Fire Protection equipment and  
obstructions.

**BOUNDARIES** – White/Black,  
Orange, White, Blue, Purple, Black  
Housekeeping and traffic  
markings.

**SAFETY** – White/Green, Green  
Safety and First Aid equipment.

Additional colors, see [uline.com](http://uline.com)

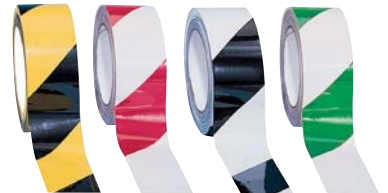

## TAPE APPLICATOR

**SPECIAL OFFER:**  
**SAVE \$78**

Order 24+ rolls of  
Uline Safety Tape  
and pay only \$55  
for H-418 applicator.

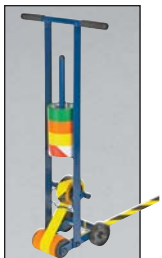

MODEL NO.	HOLDS WIDTHS	PRICE EACH	
		1	2+
H-418	1-4"	\$133	\$123

## ULINE HEAVY DUTY TAPE – Overlaminated, stays cleaner longer.

SIZE	MODEL NO. / COLOR		MIL	ROLLS/ CASE	PRICE PER ROLL (MIN. 3)					
					3	6	12	24+		
2" x 36 yds.	S-383	Yellow/Black	S-12877	Green/White	8.8	24	\$11.50	\$10.40	\$9.40	\$8.30
	S-395	White/Black	S-16869	Yellow						
	S-384	Red/White								
3" x 36 yds.	S-658	Yellow/Black	S-3356	Red/White	8.8	16	17.40	15.70	14.20	12.60
	S-3357	White/Black	S-16870	Yellow						
4" x 36 yds.	S-3565	Yellow/Black	S-13517	White/Black	8.8	12	23.00	20.90	18.80	16.70



# GAFFER'S TAPE



Works like duct tape but **leaves no residue**. Used extensively in the entertainment industry.

- Can be used outdoors, tolerates UV rays.
- Matte finish back reduces light reflection.
- Easy to hand tear.

**Economy** – Temperature range 40° to 200°F. Natural rubber adhesive. 29 oz./in. unwind adhesive.

**Standard** – Temperature range 50° to 200°F. Synthetic rubber adhesive. 25 oz./in. unwind adhesive.

**Deluxe** – Temperature range 50° to 200°F. Waterproof. Synthetic rubber adhesive. 38 oz./in. unwind adhesive.



Colors



Fluorescent Colors



## ECONOMY

SPECIFY COLOR: Black or White

MODEL NO.	COLOR	SIZE	MIL	TENSILE STRENGTH	RLS./CASE	PRICE PER ROLL (MIN. 3)			
						3	12	24	48+
S-21257	Specify	2" x 50 yds.	11	42 lbs./in.	24	<b>\$20 per roll</b>			
S-21258		3" x 50 yds.				16	\$33	\$32	\$31

## STANDARD

SPECIFY COLOR: White, Gray, Black, Purple, Blue, Electric Blue, Teal, Green, Olive, Burgundy, Red, Tan, Yellow or Brown

S-11640	Specify	1" x 60 yds.	11	45 lbs./in.	48	\$22	\$20	\$19	\$18
S-5118		2" x 60 yds.			24	34	33	32	31
S-7177		3" x 60 yds.			16	46	45	44	43
S-10519		4" x 60 yds.			12	60	59	58	56

## STANDARD FLUORESCENT

SPECIFY COLOR: Fl. Green, Fl. Pink, Fl. Yellow or Fl. Orange

S-24747	Specify	1" x 50 yds.	11	45 lbs./in.	48	\$21	\$20	\$19	\$18
S-12208		2" x 50 yds.			24	39	36	35	34

## DELUXE

S-14706	Black	2" x 50 yds.	14	69 lbs./in.	24	\$45	\$44	\$43	\$42
---------	-------	--------------	----	-------------	----	------	------	------	------

## "CABLE PATH"

MODEL NO.	COLOR	SIZE	MIL	TENSILE STRENGTH	RLS./CASE	PRICE PER ROLL			
						1	3	6	12+
S-9764	Yellow	4" x 30 yds.	11	45 lbs./in.	12	\$47	\$46	\$45	\$43

# ELECTRICAL TAPE



UL LISTED

**Uline Electrical** – Electrical tape for splicing and insulation. UL Listed.

- Rubber adhesive with soft polyvinyl chloride film backing. 1 1/4" core.

**3M 33+ Black Electrical Tape** – Splice and insulate wires up to 600V with premium grade all-weather vinyl tape.

## ULINE ELECTRICAL

SIZE	MODEL NO. / COLOR	MIL	ROLLS/CASE	LBS./CASE	PRICE PER ROLL (MIN. 10)		
					10	100	200+
3/4" x 20 yds.	S-5143 Black	7	100	18	\$1.00	\$0.90	\$0.80
	S-6752 Yellow						
	S-6750 Red						
	S-6921 Blue						
	S-6751 Green						
	S-7858 White						
1" x 20 yds. 2" x 20 yds.	S-10520 Orange	7	100	24	1.30	1.20	1.10
	S-10521 Brown						
	S-13516 Purple						
	S-13515 Gray				2.60	2.40	2.15

## 3M 33+

SIZE	MODEL NO. / COLOR	MIL	ROLLS/CASE	LBS./CASE	PRICE PER ROLL (MIN. 10)		
					10	100	200+
3/4" x 76 ft.	S-5745 Black	7	100	19	\$9.95	\$9.65	\$9.35

# ULINE DUCT TAPE

Meets UL 723

**Economy** – For general repair, bundling and patching of lightweight items.

**Industrial** – Ideal for weatherproofing, HVAC repair and ductwork.

**Heavy Duty** – High tack and tensile strength for heavy-duty sealing.

\*SPECIFY COLOR:

White Green Olive Brown Silver Black Red Yellow Blue Purple Beige Burgundy Fl. Pink Fl. Green Fl. Orange

▲SPECIFY COLOR:

MODEL NO.	DESCRIPTION	COLOR	SIZE	MIL	RLS./CASE	PRICE PER ROLL (MIN. 4)			
						4	1/2 CASE	1 CASE	2+ CASES
S-6519	Economy	Silver	2" x 60 yds.	8.5	24	\$5.25 per roll			
S-14703			3" x 60 yds.		16	10.05	\$9.60	\$9.10	\$8.60
S-377	Industrial	Specify*	2" x 60 yds.	10	24	9.85	9.40	9.00	8.60
S-7178			3" x 60 yds.		16	15.60	14.85	14.20	13.40
S-20808	Industrial Fluorescent	Specify▲	2" x 60 yds.	9	24	13.95	13.35	12.70	12.10
S-20809			3" x 60 yds.		16	20.85	19.85	18.90	18.00
S-9686	Heavy Duty	Silver	2" x 60 yds.	14.5	24	17.95	17.20	16.50	15.65



Everyone's favorite fix-all tape. Great for bundling, sealing and holding applications.

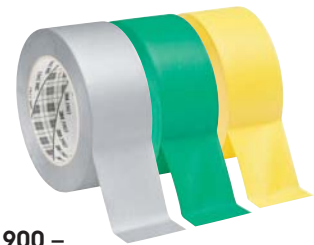

## 3M DUCT TAPE

▲SPECIFY COLOR: Gray Green Yellow Red White Blue Black

MODEL NO.	DESCRIPTION	COLOR	SIZE	MIL	RLS./CASE	PRICE PER ROLL (MIN. 3)			
						3	1/2 CASE	1 CASE	2+ CASES
S-16182	3M 1900	Silver	2" x 50 yds.	5.8	24	\$13.60	\$13.05	\$12.60	\$12.10
S-10327	3M 3903	Specify▲	2" x 50 yds.	6.2	24	13.25	12.60	12.25	11.50
S-10328		Gray	3" x 50 yds.		18	19.70	19.05	18.25	17.50
S-15993	3M 3900	Silver	2" x 60 yds.	7.7	24	20.60	19.85	19.10	18.40

\*SPECIFY COLOR: Silver Black Olive

S-2447	3M 3939	Silver	2" x 60 yds.	9.0	24	\$21.65	\$20.65	\$19.85	\$19.05
S-3763	3M 6969	Specify*	2" x 60 yds.	10.7	24	34.25	32.85	31.85	30.40

**3M 1900** – For light-duty sealing.

**3M 3903 Economy** – For color coding, labeling and bundling.

**3M 3900** – General maintenance. Wrap, seal and protect.

**3M 3939 Light Duty** – For packaging and general repairs.

**3M 6969 High Performance** – Seal ducts, insulate pipes, use for HVAC applications.

## NASHUA DUCT TAPE

Meets UL 723

**Nashua 394** – Utility grade for sealing, bundling and light repairs.

**Nashua 398** – Professional grade for HVAC repair, duct sealing and maintenance.

**Nashua 357** – Premium grade. Waterproof. For heavy-duty manufacturing.

\*SPECIFY COLOR: Silver or Black

MODEL NO.	DESCRIPTION	COLOR	SIZE	MIL	RLS./CASE	PRICE PER ROLL (MIN. 4)			
						4	1/2 CASE	1 CASE	2+ CASES
S-17235	Nashua 394	Silver	2" x 60 yds.	8.5	24	\$7.00	\$6.70	\$6.35	\$6.10
S-17236	Nashua 398	Specify*	2" x 60 yds.	11	24	12.30	11.75	11.15	10.65
S-21260			3" x 60 yds.		16	19.30	18.80	17.90	17.40
S-17237	Nashua 357	Specify*	2" x 60 yds.	13	24	20.75	19.75	18.95	18.10
S-19025			3" x 60 yds.		16	31.75	30.60	29.65	28.55



Known for its extra-tacky natural rubber adhesive that sticks to everything, even your mother-in-law.

# CRYSTAL CLEAR TAPE



TRANSPARENT

**ULINE –**  
Transparent acrylic adhesive won't yellow.

**3M –** Ideal for light-duty packaging applications.



REMOVABLE

**ULINE –** Matte poly film won't yellow.  
• Can be written on.

**3M –** Frosty finish turns invisible on paper.

## ULINE CRYSTAL CLEAR

MODEL NO.	SIZE	CORE SIZE	ROLLS/CASE	PRICE PER ROLL			
				1/2 CS.	1 CS.	2 CS.	4+ CS.
S-2747	1/2" x 72 yds.	3"	96	\$1.55	\$1.45	\$1.35	\$1.25
S-3274	3/4" x 72 yds.		96	1.65	\$1.35 per roll		
S-2306	1" x 72 yds.		72	2.10	2.00	1.90	1.80
S-14581	3/4" x 36 yds.	3"	144	1.55	1.45	1.35	1.25

				PRICE PER ROLL (MIN. 12)			
				12	48	96	144+
<b>3M 600 TRANSPARENT</b>							
S-10214	1/2" x 72 yds.	3"	72	\$8.05	\$7.70	\$7.60	\$7.40
S-6748	3/4" x 72 yds.		48	10.50	10.20	9.90	9.70
S-10215	1" x 72 yds.		36	15.00	14.75	14.60	14.25
S-9782	3/4" x 36 yds.	3"	144	3.95	3.85	3.70	3.55

				PRICE PER ROLL			
				1/2 CS.	1 CS.	2 CS.	4+ CS.
<b>ULINE REMOVABLE</b>							
S-7856	3/4" x 72 yds.	3"	96	\$1.75	\$1.65	\$1.55	\$1.45
S-14580	3/4" x 36 yds.		144	1.65	1.55	1.45	1.35

				PRICE PER ROLL (MIN. 12)			
				12	48	96	144+
<b>3M 810</b>							
S-6749	3/4" x 72 yds.	3"	48	\$7.95	\$7.70	\$7.60	\$7.45
S-10226	1" x 72 yds.		36	10.35	10.05	9.85	9.65
S-9783	3/4" x 36 yds.	3"	144	4.20	4.10	4.00	3.85

# ULINE TAPE DISPENSERS



PEARL 1" CORE

INDUSTRIAL 3" CORE

**Pearl –** Add a little glitz and glam to your desktop.  
**Industrial –** Multi-roll construction with slip-resistant base.

MODEL NO.	WIDTH	DESCRIPTION	WT. (LBS.)	PRICE EACH		
				1	3	5+
H-9305	3/4"	Pearl	1	\$7	\$6	\$5
H-440	2"	Industrial	3	16	15	14
H-462	3"	Industrial	4	18	17	16

# 3M 142 TAPE



Super strong for sealing moving boxes and heavy packages.

- Built-in dispenser keeps tape end from sticking back on roll.
- Clear backing with quick sticking rubber adhesive.

- Resists temperatures from subzero to 150°F.

## 40 LB. TENSILE STRENGTH

MODEL NO.	SIZE	MIL	ROLLS/CASE	PRICE PER ROLL (MIN. 12)			
				12	24	36	72+
S-10173	2" x 22 yds.	3.1	36	\$4.10	\$3.85	\$3.70	\$3.60

# 3M TAPE DISPENSERS



3M C25

H-2312



3M P52W

H-2314

**3M C25 Desktop –** For busy office and retail counters.

**3M P52W Heavy Duty –** Workhorse for your warehouse. 7 lb. weighted base for stability.

MODEL NO.	WIDTH	DESCRIPTION	WT. (LBS.)	PRICE EACH		
				1	3	5+
H-2312	1"	3M C25 Desktop	4	\$78	\$68	\$60
H-2314	2"	3M P52W Multi-Roll	7	177	169	164

H-2312-BLADE Replacement Blade for H-2312 and H-2315 3+/\$14.80 ea.

## 3" CORE



3M C23

H-2315



3M C22

H-2322

**3M C23 Heavy Duty –** Commercial grade for checkout counters and service desks.

**3M C22 Heavy Duty Multi-Roll –** Recommended for studios and frame shops. Holds two 1" tape rolls.

MODEL NO.	WIDTH	DESCRIPTION	WT. (LBS.)	PRICE EACH		
				1	3	5+
H-2315	1"	3M C23 Heavy Duty	4	\$111	\$99	\$91
H-2322	2"	3M C22 Multi-Roll	5	148	142	137

H-2322B Replacement Blade for H-2322 3+/\$12.60 ea.



# ULINE CLEAR CARTON SEALING TAPE

3" CORE MEETS USPS AND UPS REGULATIONS

MODEL NO.	SIZE	MIL	ROLLS/CASE	LBS./CASE	PRICE PER ROLL		
					1/2 CS.	1 CS.	2+ CS.
S-15575	2" x 110 yds.	2.0	36	25	\$4.75	\$4.50	\$4.25
S-15576	3" x 110 yds.		24	20	6.00	5.75	5.25
S-14564	2" x 55 yds.	2.6	36	18	3.75	3.50	3.00
S-16982	2" x 110 yds.		36	27	6.00	5.75	5.25
S-14565	3" x 55 yds.	2.6	24	16	5.25	5.00	4.50
S-16983	3" x 110 yds.		24	27	8.25	7.25	6.75
S-14566	2" x 55 yds.	3.1	36	19	4.50	4.25	4.00
S-14567	3" x 55 yds.		24	20	6.00	5.75	5.50

High performance crystal clear packaging tape seals mailroom shipments tight.

- Acrylic adhesive resists aging and works in cold temperatures.
- Polypropylene film resists tears and splits.



## 3M 3850 CARTON SEALING TAPE

3" CORE MEETS USPS AND UPS REGULATIONS

MODEL NO.	SIZE	MIL	ROLLS/CASE	LBS./CASE	PRICE PER ROLL		
					12	24	36+
S-12187	2" x 55 yds.	3.1	36	16	\$7.00	\$6.70	\$6.60

Crystal clear packaging tape.

- Pack moving boxes.
- Resists splitting or tearing.
- Quick stick hot melt tape.



## COMFORT GRIP TAPE DISPENSERS

Cushioned foam grip helps reduce operator fatigue and discomfort.

- Adjustable brake for tension control.
- Natural rubber roller.

MODEL NO.	DESCRIPTION	PRICE EACH				EXTRA BLADES
		1	2	6	10+	
H-324	2" Comfort Grip	\$16	\$15	\$14	\$12	H-324B \$15/PKG. OF 10
H-325	3" Comfort Grip	29	25	20	17	H-325B \$16/PKG. OF 10

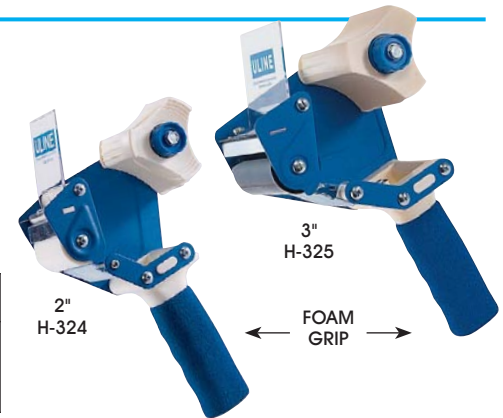

## TAPE DISPENSERS

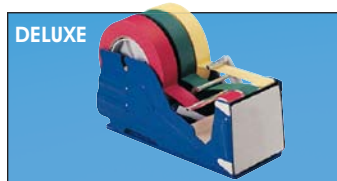

**Deluxe** – Tiered metal bars help guide and separate up to 3 rolls of 1" tape.



**Bench** – Quickly attaches to your packaging table or workbench. C-clamp included.

MODEL NO.	DESCRIPTION	CORE SIZE	PRICE EACH		
			1	3	5+
H-835	2" Deluxe		\$22	\$21	\$20
H-836	3" Deluxe		25	24	23
H-958	2" Bench		21	19	17
H-6479	3" Bench		24	22	20

## ULINE SURE GRIP COMBO



Extremely comfortable rubber knife handle and side-load tape dispenser.

Try them both out!

MODEL NO.	DESCRIPTION	PRICE EACH
H-1603	2" Dispenser and Knife	\$14
H-1822	3" Dispenser and Knife	21

# ULINE TAPE DISPENSERS



H-725  
MANUAL



H-1036 ELECTRONIC  
H-2243 BATTERY

**FREE OFFER**  
Order a Uline Tape Dispenser and receive a **FREE** case of S-2350 Uline Tape upon request.

**1 YEAR WARRANTY**

MODEL NO.	DESCRIPTION	FITS TAPE WIDTHS	SHPG. WT.	PRICE EACH		EXTRA BRUSH	EXTRA WATER BOTTLE
				1	2+		
H-725	Manual	1 1/2 - 4"	22 lbs.	\$289	\$279	H-725B \$71	H-725WB \$29
H-1036	Electronic		35 lbs.	924	899		
H-2243	Battery Operated		38 lbs.	1,249	1,199	H-2244 Battery \$299	H-2245 Charger \$279

## MANUAL

Seals carton after carton without breaking down.

- Sturdy, corrosion-resistant body with high-quality blades.
- Cuts tape lengths up to 43".
- 45 oz. water bottle.

## ELECTRONIC

One touch measures, moistens and cuts tape automatically.

- Dispenses 2 1/2 feet of tape per second.
- Cuts tape lengths up to 46". Switch adds extra 2" increments.
- 45 oz. water bottle.

## BATTERY OPERATED

Totally portable. Move anywhere in your warehouse.

- Approximately 7,000 cuts before 2-hr. charge is needed.
- Includes battery pack and charger. Battery lasts up to 2,000 charges.

# MARSH® TAPE DISPENSERS



H-1358  
MANUAL



H-1360  
ELECTRONIC

**18 MONTH WARRANTY**

MODEL NO.	DESCRIPTION	FITS TAPE WIDTHS	SHPG. WT.	PRICE EACH		EXTRA BRUSH	EXTRA WATER BOTTLE
				1	2+		
H-1358	Manual	1 - 3"	28 lbs.	\$445	\$435	H-1358B \$24	H-1358WB \$22
H-1359	Manual w/ Heater		28 lbs.	515	505		
H-1360	Electronic		36 lbs.	1,175	1,145		

New sleek design and added features.

- Now handles Jumbo 1,000' tape rolls.

## MANUAL

- Cuts tape lengths up to 36".
- Giant 70 oz. water bottle.
- H-1359 – Heated water bottle quickly activates glue.

## ELECTRONIC

Convenient keypad for fastest possible carton closure.

- Electronic circuit board eliminates adjustments. No mechanical parts.
- Pre-set 20 different lengths up to 96".
- Heated 70 oz. water bottle.

# AUTOMATIC TAPE DISPENSERS



H-99  
INDUSTRIAL

For repetitive taping. Cuts and dispenses exact lengths.



H-2590  
HEAVY DUTY

## INDUSTRIAL

- Sturdy, durable workhorse.
- Cuts exact lengths from 3/4 to 39 3/4".
- Works with strapping, poly and masking tape up to 2" wide.

## HEAVY DUTY

- High volume machine.
- Cuts exact lengths from 2 to 394".
- Works with the thickest tape, including duct, gaffer's and filament, up to 3" wide.

MODEL NO.	DESCRIPTION	SIZE	CORE SIZE	MAX. TAPE WIDTH	MAX. ROLL DIAM.	LBS. EACH	PRICE EACH	
							1	2+
H-99	Industrial	8 x 5 x 5"	3"	2"	7"	6	\$700	\$675
H-2590	Heavy Duty	9 x 7 x 12"		3"	9"	21	1,875	1,775

# CUSTOM PRINTED KRAFT TAPE

**REINFORCED**

Advertise your company and protect your packages.

- 1st-time orders ship 14 working days after proof approval. Repeat orders, 7 days.
- Ink colors: Red, Green, Blue or Black.
- With camera-ready artwork – No plate charge. Without camera-ready artwork – \$50 plate charge.

## ECONOMY #240 GRADE

**FREE SHIPPING**

MODEL NO.	SIZE	COLOR	GRADE	ROLLS/CASE	LBS./CASE	PRICE PER CASE (MIN. 6)		
						6	12	24+
S-7601	2.83" x 375'	Kraft		8	23	\$138	\$133	\$117
S-7583	2.83" x 450'	Kraft	#240	10	34	186	169	147
S-7584	2.83" x 450'	White		10	34	198	182	169

## INDUSTRIAL #260 GRADE

S-5039	3" x 375'	Kraft		8	24	\$144	\$140	\$123
S-5040	3" x 450'	Kraft	#260	10	35	198	182	167
S-5041	3" x 450'	White		10	35	216	198	187



# PRE-PRINTED KRAFT TAPE

**REINFORCED**

Give maximum attention to security and shipping directions.



S-1074

S-3324

S-15697

MODEL NO.	SIZE	DESCRIPTION	GRADE	ROLLS/CASE	LBS./CASE	PRICE PER CASE			
						1	3	6	10+
S-1074		Warning – Pilfer Proof							
S-3324	3" x 450'	Fragile – Handle with Care	#260	10	34	\$160	\$151	\$148	\$138
S-15697		Stop – If Seal Is Broken							



# KRAFT PAPER TAPE

**NON-REINFORCED**

Water-activated tape for low-volume packaging.

- 60 lb. kraft paper with water-activated gummed adhesive.
- H-801 patented design moistens tape with smooth, constant tension.

MODEL NO.	SIZE	COLOR	GRADE	ROLLS/CASE	LBS./CASE	PRICE PER CASE			
						1	3	6	10+
S-208		Kraft		14	36	\$93	\$91	\$87	\$85
S-3044	2" x 600'	White	#160			123	116	112	108
S-212		Kraft		10	38	96	93	91	87
S-11693	3" x 600'	White	#160			130	123	120	112
H-801	3" Dispenser for Reinforced and Non-Reinforced Tape					\$150 each	2+/\$145 each		



# PRESSURE SENSITIVE KRAFT TAPE

Stronger than masking tape and as easy to use.

- No dispenser or water required.
- Unroll desired length and tear by hand.

MODEL NO.	SIZE	COLOR	TENSILE STRENGTH	ROLLS/CASE	LBS./CASE	PRICE PER ROLL (MIN. 12)			
						12	24	48	96+
S-14419	1" x 60 yds.			36	18	\$4.80	\$4.55	\$4.35	\$4.25
S-909	2" x 60 yds.			24	25	9.15	8.70	8.30	8.00
S-2492	3" x 60 yds.	Kraft	42 lbs.	16	24	13.35	12.80	12.25	11.75
S-14420	4" x 60 yds.			12	24	17.70	16.95	16.30	15.60

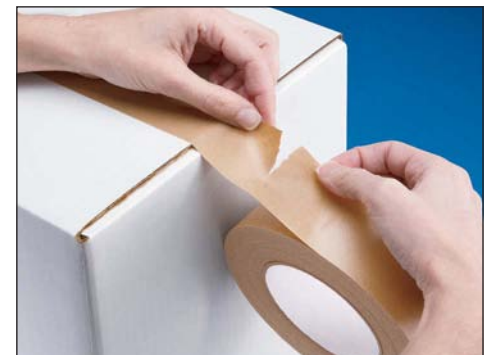



## MANUAL 333 PLUS

The #1 selling manual kraft tape machine in the U.S.

- Manual lever dispenses tape up to 30" long.
- Heavy-duty steel frame with minimal moving parts.
- Trouble free – Easy to clean.

H-669 – Heated water bottle activates glue quickly.

**1 YEAR WARRANTY**



H-35

MODEL NO.	DESCRIPTION	FITS TAPE WIDTHS	SHPG. WT.	PRICE EACH			EXTRA BRUSH	EXTRA WATER BOTTLE
				1	2	3+		
H-35	Manual 333 Plus	1½ - 3"	22 lbs.	\$450	\$440	\$430	H-35B	H-35WB
H-669	Manual w/ Heater	1½ - 3"	23 lbs.	550	540	520	Set of 2 \$48	\$23 each

## ELECTRONIC 555eS SERIES

The #1 selling electronic kraft tape machine in the U.S.

- Holds up to 1,000' tape rolls – Largest capacity in the industry.
- Electronic panel dispenses longer tape lengths – Up to 90".
- Top heater – For quick, strong application.
- Larger water bottle for fewer refills, less downtime.
- Automatic 555eSA – Advanced programmable features for repetitive carton sealing.

**2 YEAR WARRANTY**



H-800

UL LISTED

MODEL NO.	DESCRIPTION	FITS TAPE WIDTHS	SHPG. WT.	PRICE EACH			EXTRA BRUSH	EXTRA WATER BOTTLE
				1	2	3+		
H-800	Electronic 555eS	1½ - 3"	33 lbs.	\$1,320	\$1,305	\$1,290	H-800B	H-800WB
H-1037	Automatic 555eSA	1½ - 3"	33 lbs.	1,400	1,350	1,320	\$60 each	\$30 each

## CADILLAC 755e TAPE DISPENSER

The **quietest**, most **reliable** and **accurate** tape machine available.

- Quality construction with few moving parts – Low maintenance.
- Handles tape up to 4" wide; lengths to 75".
- Low profile fits in tight spaces.
- Smooth cutting heavy-duty blades.

**1 YEAR WARRANTY**



H-16

MODEL NO.	DESCRIPTION	FITS TAPE WIDTHS	SHPG. WT.	PRICE EACH		EXTRA BRUSH	EXTRA WATER BOTTLE
				1	2+		
H-16	Cadillac 755e	1½ - 4"	42 lbs.	\$1,830	\$1,780	H-16B Set of 2 \$57	H-16WB \$31 each



MANUAL

H-35

**FREE OFFER**  
**SAVE \$102**

Order an H-35 Dispenser and receive a **FREE** case of S-2350 Uline tape upon request.

MODEL NO.	DESCRIPTION	SHPG. WT.	PRICE EACH
H-565	Better Pack 333 Plus Special Offer	43 lbs.	\$450

**FREE OFFER**  
**SAVE \$139**

Order an H-800 Dispenser and receive a **FREE** case of S-6645 Uline Jumbo Reinforced Kraft Tape upon request.



H-800

JUMBO  
1,000 ft.



STANDARD  
450 ft.

ELECTRONIC

MODEL NO.	DESCRIPTION	SHPG. WT.	PRICE EACH
H-802	Better Pack 555eS Special Offer	65 lbs.	\$1,320



## ULINE

MODEL NO.	SIZE	COLOR	ROLLS/CASE	LBS./CASE	PRICE PER CASE			
					1	3	6	10+

**SAVE A BUCK** Recommended for boxes under 20 lbs.

S-7838	2.75" x 375'	Kraft	8	18	\$68	\$64	\$60	\$58
S-7839	2.75" x 450'		10	28	99	93	88	84

**ECONOMY** Stronger than paper for sealing 20-40 lb. boxes.

S-1947	3" x 375'	Kraft	8	23	\$77	\$75	\$71	\$68
S-1948	3" x 450'		10	34	113	103	98	96
S-2338	3" x 375'	White	8	28	101	94	87	86

**INDUSTRIAL** Save on our Uline house brand. For closing 40-60 lb. boxes.

S-2350	3" x 375'	Kraft	8	23	\$102	\$94	\$90	\$86
S-2351	3" x 450'		10	34	\$113 per case any quantity			
S-6582	3" x 600'		10	45	176	171	159	152
S-2352	3" x 450'	White	10	34	173	161	149	148

**DELUXE** Recommended for closing 60-80 lb. boxes.

S-5756	3" x 375'	Kraft	8	25	\$118	\$109	\$102	\$95
S-5757	3" x 450'		10	36	167	148	142	137
S-5758	3" x 450'	White	10	36	187	176	169	167

## JUMBO

MODEL NO.	SIZE	COLOR	GRADE	ROLLS/CASE	LBS./CASE	PRICE PER CASE		
						1	3	6+
S-6644	2.83" x 1,000'	Kraft	Economy #240	6	41	\$135	\$124	\$118
S-6645	3" x 900'		Industrial #260			139	135	124

## CENTRAL

MODEL NO.	SIZE	COLOR	ROLLS/CASE	LBS./CASE	PRICE PER CASE			
					1	3	6	10+

**ECONOMY** #240 grade. Recommended for closing 20-40 lb. boxes.

S-5759	2.83" x 375'	Kraft	8	23	\$95	\$93	\$88	\$86
S-5760	2.83" x 450'		10	30	139	129	122	119
S-5761	2.83" x 450'	White	10	30	164	149	147	146

**INDUSTRIAL** #260 grade. Recommended for closing 40-60 lb. boxes.

S-213	3" x 375'	Kraft	8	23	\$116	\$110	\$103	\$96
S-408	3" x 450'		10	34	166	149	139	138
S-112	3" x 450'	White	10	34	207	197	181	175

**DELUXE** #270 grade. Recommended for closing 60-80 lb. boxes.

S-3609	3" x 375'	Kraft	8	25	\$136	\$130	\$119	\$112
S-3610	3" x 450'		10	36	185	173	164	152
S-3611	3" x 450'	White	10	36	237	217	212	201

**HEAVY DUTY** #285 grade. Recommended for closing 80-100 lb. boxes.

S-9683	3" x 400'	Kraft	10	46	\$230	\$210	\$206	\$192
--------	-----------	-------	----	----	-------	-------	-------	-------

Save money with Uline's house brand.

- High grade kraft paper reinforced with **strong fiberglass** yarns.
- **Water-activated** adhesive bonds to corrugated even in dusty or dirty conditions.
- Reinforced tape seals boxes with one piece of tape.
- Jumbo – Recommended for large volume users. Over twice the length of standard rolls – Reduces downtime.

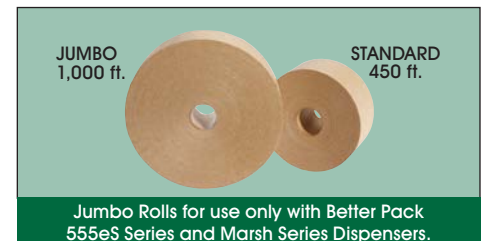

# SECURITY TAPE AND STRIPS

## INDUSTRIAL TAPE

Impossible to realign once your box has been opened.

- Easily identify pilferage at a glance. Easily identify tampered goods.

### ULINE

MODEL NO.	MESSAGE	SIZE	MIL	ROLLS/CASE	LBS./CASE	PRICE PER ROLL			
						12-18	36	72	180+
S-9926	"Tamper Evident"	2" x 110 yds.	2.5	36	26	\$7.90	\$7.40	\$6.30	\$6.10
S-11791		3" x 110 yds.		24	26	12.40	11.40	10.50	9.50
S-9927	"If Seal Has Been Broken, Check Contents"	2" x 110 yds.	2.5	36	26	7.90	7.40	6.30	6.10
S-15625		3" x 110 yds.		24	26	12.40	11.40	10.50	9.50
S-9928	"Security Tape"	2" x 110 yds.	2.5	36	26	7.90	7.40	6.30	6.10
S-15626		3" x 110 yds.		24	26	12.40	11.40	10.50	9.50

### ULINE MACHINE LENGTH

MODEL NO.	MESSAGE	SIZE	MIL	ROLLS/CASE	LBS./CASE	PRICE PER ROLL			
						6	12	24	48+
S-17148	"Tamper Evident"	2" x 1,000 yds.	1.9	6	26	\$54	\$51	\$48	\$46

### 3M 3779

MODEL NO.	MESSAGE	SIZE	MIL	ROLLS/CASE	LBS./CASE	12-18	36	72	180+
						S-15627	"Check Seal Before Accepting"	2" x 110 yds.	1.9
S-15628	3" x 110 yds.	24	18	22.90	20.90	19.90	17.35		



## DELUXE TAPE AND STRIPS

Stop theft of valuable or high-risk goods – Software, jewelry, laptops and CDs.

- If tape has been lifted or removed, a highly visible "OPENED" message appears on the box.
- Consecutively numbered every 9 inches – Makes every strip of tape different.
- Uline security strips turn plain envelopes into tamperproof envelopes.

### ULINE ROLLS

SPECIFY COLOR: Red or Blue

MODEL NO.	SIZE	MIL	ROLLS/CASE	LBS./CASE	PRICE PER ROLL			
					1	6	12	36+
S-6724	2" x 60 yds.	2.5	36	15	\$46	\$42	\$39	\$36
S-17149	3" x 60 yds.		24	16	74	68	62	56

### ULINE STRIPS

MODEL NO.	SIZE	MIL	STRIPS/PKG.	LBS./PKG.	PRICE PER PACKAGE			
					1	6	12	36+
S-7590	2 x 9"	2.5	100	1	\$42	\$39	\$35	\$32



## HIDDEN MESSAGE TAPE

Seal high value products, pharmaceuticals or electronics.

- Looks like plain tape until lifted or removed.
- Cannot be resealed.
- Message transfers completely to box surface when tampered with.

SPECIFY COLOR: Red, Blue or Green

MODEL NO.	SIZE	MIL	ROLLS/CASE	LBS./CASE	PRICE PER ROLL			
					1	6	24	48+
S-16880	1" x 55 yds.	3.9	48	17	\$13	\$12	\$11	\$10
S-15622	2" x 55 yds.		24	17	25	23	21	19
S-16881	3" x 55 yds.		16	17	42	39	35	32





# ULINE PAINTER'S MASKING TAPE

## INDOOR

ULINE – 21 lb. tensile strength.

10 day removal

MODEL NO.	SIZE	MIL	ROLLS/CASE	LBS./CASE	PRICE PER ROLL			
					1/2 CASE	1 CASE	2 CASES	4+ CASES
S-24181	1" x 60 yds.	5.3	36	12	\$4.00	\$3.50	\$3.25	\$2.75
S-24182	2" x 60 yds.		24	16	8.00	\$5.50 per roll		
S-24183	3" x 60 yds.		16	17	11.00	10.00	9.00	8.00



Uline Indoor – Mask walls, edges and trim. Holds up to 10 days with clean removal.

## OUTDOOR

ULINE – 23 lb. tensile strength.

14 day removal

MODEL NO.	SIZE	MIL	ROLLS/CASE	LBS./CASE	PRICE PER ROLL			
					1/2 CASE	1 CASE	2 CASES	4+ CASES
S-19018	1/2" x 60 yds.	5.5	72	14	\$3.30	\$3.15	\$2.75	\$2.45
S-14688	3/4" x 60 yds.		48	14	4.00	3.65	3.40	3.15
S-13752	1" x 60 yds.		36	15	5.30	4.95	4.45	3.95
S-14689	1 1/2" x 60 yds.	24	14	14	7.90	7.35	6.65	5.95
S-9759	2" x 60 yds.	24	17	17	9.95	\$7.95 per roll		
S-14697	3" x 60 yds.	16	16	16	15.00	13.90	12.75	11.75
S-19019	6" x 60 yds.	8	15	15	32.35	30.75	29.75	27.00



Uline and 3M Outdoor – Resists direct sunlight. Holds up to 14 days with clean removal.

# 3M PAINTER'S MASKING TAPE

## OUTDOOR

3M 2090 – 27 lb. tensile strength.

14 day removal

MODEL NO.	SIZE	MIL	ROLLS/CASE	LBS./CASE	PRICE PER ROLL			
					1/2 CASE	1 CASE	2 CASES	4+ CASES
S-6541	3/4" x 60 yds.	5.4	48	14	\$4.75	\$4.10	\$4.00	\$3.80
S-6542	1" x 60 yds.		36	15	6.20	5.55	5.35	5.05
S-10283	1 1/2" x 60 yds.		24	14	9.25	8.20	8.00	7.55
S-6543	2" x 60 yds.	36	23	23	12.30	\$9.95 per roll		
S-11664	3" x 60 yds.	12	12	12	18.50	16.30	15.85	14.90

# FROGTAPE® PAINTER'S TAPE

21 DAY TAPE

Stop paint from bleeding. PaintBlock® technology leaves razor sharp paint lines and a perfect finish.

- For unfinished trim, cured painted walls, woodwork, metal, glass and vinyl.
- Works with latex paints; also use with solvent and alkyd paints and stains.

FROGTAPE® – 22 lb. tensile strength.

MODEL NO.	SIZE	MIL	ROLLS/CASE	LBS./CASE	PRICE PER ROLL (MIN. 2)		
					2	6	12+
S-16109	1" x 60 yds.	5.7	36	12	\$7.35	\$7.10	\$6.85
S-16110	1 1/2" x 60 yds.		24	18	10.45	9.85	9.65
S-16111	2" x 60 yds.		20	17	14.55	12.55	12.00



- Clean removal up to 21 days or up to 7 days in sunlight.

# 3M 203 MASKING TAPE



Sticks instantly to round and irregular surfaces.

See [uline.com](http://uline.com) for more information.

# LIME GREEN COMBO

E-Z Glide Knife – Smoothest operation of any Uline knife. Retractable – 3 blade positions.

Heavy-Duty Tape Dispenser – Italian made with solid steel frame. Natural rubber roller.

MODEL NO.	DESCRIPTION	PRICE EACH
H-7076	2" Dispenser and Knife	\$21
H-7077	3" Dispenser and Knife	\$32



Everything is lime these days.



## 3M MASKING TAPE

### GENERAL PURPOSE

3M 200/201+ – Utility grade for holding and bundling. Withstands 200°F for up to 30 minutes.

3M 2307 – For industrial applications. Removes cleanly from stainless steel and powder coatings. Withstands 200°F for 1 hour.

### HIGH TEMPERATURE

3M 234 – Heavy-duty Scotch® brand. General purpose industrial applications. Withstands 250°F for up to 30 minutes.

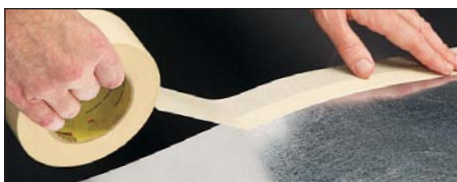

3M 232 – Tough high-performance professional grade for masking or bundling. Takes 250°F for up to 30 mins.

3M 231 – Excellent for reducing paint edge buildup. Leaves no adhesive residue. Can handle 300°F for 30 mins.



3M 233+/401+ – This automotive tape neatly conforms to curves. Clean removal. Withstands 250°F for 30 minutes.

### 3M 200/201+ – 19 lb. tensile strength.

MODEL NO.	SIZE	MIL	ROLLS/CASE	LBS./CASE	PRICE PER ROLL (MIN. 12)			
					12	36	72	144+
S-6537	1/2" x 60 yds.	4.4	72	12	\$2.85	\$2.75	\$2.55	\$2.40
S-6538	3/4" x 60 yds.		48	12	3.55	3.40	3.30	3.15
S-6539	1" x 60 yds.		36	12	4.50	4.30	4.15	3.80
S-6540	2" x 60 yds.		24	18	8.60		<b>\$7.30 per roll</b>	
S-10298	3" x 60 yds.		12	12	13.45	12.40	11.85	11.25
S-10299	4" x 60 yds.		8	10	18.45	16.85	16.10	15.00

### 3M 2307 – 23 lb. tensile strength.

MEETS MIL SPEC. ASTM-D6123

S-2279	1/2" x 60 yds.	5.2	72	14	\$4.25	\$4.05	\$3.60	\$3.50
S-1847	3/4" x 60 yds.		48	14	5.15	4.90	4.50	4.40
S-1848	1" x 60 yds.		36	14	6.30	5.95	5.60	5.40
S-3050	1 1/2" x 60 yds.		24	14	9.90	9.35	8.65	8.30
S-1849	2" x 60 yds.		24	19	12.50	11.80	11.25	10.55
S-3051	3" x 60 yds.		12	14	18.95	18.15	17.05	16.00

### 3M 234 – 27 lb. tensile strength.

MEETS MIL SPEC. ASTM-D6123

S-10277	1/2" x 60 yds.	5.9	72	15	\$9.55	\$9.20	\$9.10	\$8.75
S-5697	3/4" x 60 yds.		48	15	11.55	11.30	11.05	10.65
S-5698	1" x 60 yds.		36	16	13.90	13.60	13.05	12.60
S-10279	1 1/2" x 60 yds.		24	16	21.65	21.05	20.65	19.75
S-5699	2" x 60 yds.		24	20	27.70	26.90	26.20	25.20
S-5700	3" x 60 yds.		12	15	41.40	40.25	39.05	37.80

### 3M 232 – 27 lb. tensile strength.

MEETS MIL SPEC. ASTM-D6123

S-5123	3/4" x 60 yds.	6.3	48	16	\$14.70	\$14.25	\$13.75	\$13.50
S-5124	1" x 60 yds.		36	17	17.40	16.90	16.40	15.75
S-10282	1 1/2" x 60 yds.		24	16	28.65	27.75	27.00	26.25
S-5125	2" x 60 yds.		24	22	33.25	32.10	31.20	30.45
S-5126	3" x 60 yds.		12	16	56.05	54.55	53.05	51.45

### 3M 231 – 28 lb. tensile strength.

MEETS MIL SPEC. ASTM-D6123

S-10273	1/2" x 60 yds.	7.6	72	16	\$12.65	\$12.40	\$11.95	\$11.70
S-7830	3/4" x 60 yds.		48	16	14.85	14.35	13.95	13.70
S-7831	1" x 60 yds.		36	16	18.55	18.00	17.60	16.85
S-7832	2" x 60 yds.		24	22	35.75	34.80	34.00	32.90
S-10276	3" x 60 yds.		12	16	53.80	52.20	50.50	49.15

### 3M 233+/401+ – 25 lb. tensile strength.

S-15920	1/4" x 60 yds.	6.7	96	15	\$5.40	\$5.30	\$5.20	\$4.85
S-15007	1/2" x 60 yds.		48	11	5.95	5.80	5.65	5.30
S-7833	3/4" x 60 yds.		48	17	7.35	7.00	6.60	6.50
S-7834	1" x 60 yds.		24	11	9.50	9.30	9.00	8.80
S-10296	1 1/2" x 60 yds.		16	11	14.25	13.45	12.85	12.60
S-7835	2" x 60 yds.		12	11	19.50	18.90	18.20	17.60
S-10297	3" x 60 yds.	8	12	31.15	30.30	29.25	28.35	



**GENERAL PURPOSE – 18 lb. tensile strength.**

MEETS MIL SPEC. ASTM-D6123

MODEL NO.	SIZE	MIL	ROLLS/CASE	LBS./CASE	PRICE PER ROLL (MIN. 12)			
					12	36	72	144+
S-14726	1/2" x 60 yds.		72	13	\$1.30	\$1.25	\$1.20	\$1.15
S-11735	3/4" x 60 yds.		48	13	1.55	1.50	1.40	1.35
S-11736	1" x 60 yds.	4.8	36	12	2.05	\$1.70 per roll		
S-11737	2" x 60 yds.		24	15	3.90	\$3.35 per roll		
S-12880	3" x 60 yds.		16	15	5.85	5.55	5.30	4.95

**ULINE MASKING TAPE**

**GENERAL PURPOSE**

Use for packaging and everyday needs.

**INDUSTRIAL**

Resistant to water and oil. Designed for splicing and holding applications.

**INDUSTRIAL – 20 lb. tensile strength.**

MEETS MIL SPEC. ASTM-D6123

MODEL NO.	SIZE	MIL	ROLLS/CASE	LBS./CASE	PRICE PER ROLL (MIN. 12)			
					12	36	72	144+
S-3049	1/4" x 60 yds.		144	15	\$1.25	\$1.20	\$1.15	\$1.10
S-315	1/2" x 60 yds.		72	15	1.40	1.30	1.25	1.20
S-316	3/4" x 60 yds.		48	14	1.80	1.60	1.55	1.45
S-317	1" x 60 yds.	5.5	36	13	2.40	\$2.05 per roll		
S-1456	1 1/2" x 60 yds.		24	11	3.50	3.35	3.20	3.00
S-318	2" x 60 yds.		24	16	4.70	\$3.95 per roll		
S-349	3" x 60 yds.		16	16	7.05	6.70	6.30	5.95



Easy one-handed operation.

Free 1" SuperMask Dispenser with Uline 1" Masking Tape orders of 2+ cases.

**HEAVY DUTY – 21 lb. tensile strength.**

MEETS MIL SPEC. ASTM-D6123

MODEL NO.	SIZE	MIL	ROLLS/CASE	LBS./CASE	PRICE PER ROLL (MIN. 12)			
					12	36	72	144+
S-5730	1/2" x 60 yds.		72	15	\$1.60	\$1.55	\$1.45	\$1.40
S-5731	3/4" x 60 yds.		48	14	2.45	2.35	2.25	2.15
S-5732	1" x 60 yds.	5.9	36	13	3.15	2.90	2.75	2.60
S-5733	2" x 60 yds.		24	16	6.15	5.85	5.45	5.15
S-14727	3" x 60 yds.		16	16	9.05	8.60	8.05	7.60

**HEAVY DUTY**

Contractor's grade for painting and construction industries.



**CHART TAPE**

Create thin, precisely spaced lines on dry erase boards, walls, poster board and paper.

**BLACK CHART TAPE – 33 lb. tensile strength.**

MODEL NO.	SIZE	MIL	ROLLS/CASE	COLOR	PRICE PER ROLL (SOLD IN CASE QTYS.)		
					10-15	30	60+
S-15835	1/8" x 54'		15	Black	\$7.10	\$6.90	\$6.65
S-15836	1/4" x 54'	6.4	10	Black	7.30	7.10	6.90

**COLORED – 18 lb. tensile strength.**

SPECIFY COLOR: Red, Green, Yellow, Blue, Orange, Purple, White or Black

MODEL NO.	SIZE	MIL	ROLLS/CASE	LBS./CASE	PRICE PER ROLL (MIN. 12)			
					12	36	72	144+
S-15894	1/2" x 60 yds.		72	9	\$2.85	\$2.70	\$2.55	\$2.45
S-2489	3/4" x 60 yds.		48	14	3.70	3.50	3.35	3.15
S-2490	1" x 60 yds.	4.6	36	13	4.80	4.60	4.35	4.10
S-2491	2" x 60 yds.		24	16	9.30	8.85	8.40	7.95

**COLORED**

Ideal for color coding shipments and inventory.





# 3M STRAPPING TAPE



H-303 DISPENSER

**3M 8934** – Recommended for light-duty applications.

**3M 897** – Excellent for box sealing, bundling and unitizing pallets.

**3M 8915** – Secures parts inside appliances during shipping. Removes cleanly, leaves no residue.

**3M 893 and 3M 898** – Combines tough polypropylene backing with high-performance rubber adhesive.



**3M 890MSR** – Extra heavy duty. The strongest strapping tape Uline sells.



H-728 Deluxe 3M Filament Dispenser

- Applies "L" clips in one easy motion.
- Good for fast, repetitive packaging.
- Tape held in place with static pad.

## 3M 8934 ECONOMY – 100 LB. TENSILE STRENGTH

MODEL NO.	SIZE	ROLLS/CASE	LBS./CASE	PRICE PER ROLL (MIN. 12)				
				12	24	48	72	96+
S-3297	1/2" x 60 yds.	72	14	\$4.65	\$4.30	\$4.10	\$3.75	\$3.55
S-3298	3/4" x 60 yds.	48	15	6.55	6.10	5.80	5.55	5.20
S-3299	1" x 60 yds.	36	14	9.00	8.50	7.95	7.45	6.85
S-3300	2" x 60 yds.	24	18	17.45	16.50	15.30	14.20	13.45
S-7828	3" x 60 yds.	12	14	26.10	24.75	23.10	21.50	20.25

## 3M 897 STANDARD – 170 LB. TENSILE STRENGTH

MODEL NO.	SIZE	ROLLS/CASE	LBS./CASE	PRICE PER ROLL (MIN. 12)				
				12	24	48	72	96+
S-5567	1/2" x 60 yds.	72	17	\$6.70	\$6.15	\$5.95	\$5.55	\$5.40
S-5568	3/4" x 60 yds.	48	17	8.90	8.45	8.00	7.60	7.30
S-5569	1" x 60 yds.	36	17	12.20	11.60	11.10	10.60	9.90
S-5570	2" x 60 yds.	24	22	23.60	22.60	21.55	20.45	19.55

## 3M 8915 STANDARD – 170 LB. TENSILE STRENGTH

MODEL NO.	SIZE	ROLLS/CASE	LBS./CASE	PRICE PER ROLL (MIN. 12)				
				12	24	48	72	96+
S-11927	1" x 60 yds.	36	18	\$17.40	\$16.90	\$16.45	\$15.95	\$15.60
S-16086	2" x 60 yds.	24	22	35.25	34.25	33.35	32.45	31.55

## 3M 893 INDUSTRIAL – 300 LB. TENSILE STRENGTH

MODEL NO.	SIZE	ROLLS/CASE	LBS./CASE	PRICE PER ROLL (MIN. 12)				
				12	24	48	72	96+
S-574	1/2" x 60 yds.	72	18	\$10.80	\$10.35	\$9.95	\$9.40	\$9.10
S-575	3/4" x 60 yds.	48	19	15.30	14.85	14.20	13.50	12.75
S-576	1" x 60 yds.	36	19	19.80	19.20	18.30	17.50	16.65
S-1895	2" x 60 yds.	24	25	39.25	37.60	36.25	34.60	32.90

## 3M 898 SUPER STRENGTH – 380 LB. TENSILE STRENGTH

MEETS FED. SPEC. ASTM-D5330, TYPE II

MODEL NO.	SIZE	ROLLS/CASE	LBS./CASE	PRICE PER ROLL (MIN. 12)				
				12	24	48	72	96+
S-1837	1/2" x 60 yds.	72	22	\$16.90	\$16.55	\$16.05	\$15.40	\$15.05
S-1838	3/4" x 60 yds.	48	22	23.70	22.95	22.35	21.70	21.10
S-1839	1" x 60 yds.	36	22	29.45	28.65	27.85	27.05	26.00
S-1896	2" x 60 yds.	24	28	61.70	59.95	58.10	56.40	54.65
S-10195	3" x 60 yds.	12	22	92.70	90.10	87.40	85.00	82.30

## 3M 890MSR SUPER STRENGTH – 600 LB. TENSILE STRENGTH

\*Black

MODEL NO.	SIZE	ROLLS/CASE	LBS./CASE	PRICE PER ROLL (MIN. 12)				
				12	24	48	72	96+
S-10190	3/4" x 60 yds.	48	29	\$33.60	\$32.55	\$31.70	\$30.55	\$29.40
S-10191	1" x 60 yds.	36	29	49.45	48.20	46.15	44.95	43.65
S-10192	2" x 60 yds.	24	39	88.20	85.55	82.65	79.90	77.15
S-11906*	1" x 60 yds.	36	29	54.10	52.50	50.90	49.30	47.65

## 3M FILAMENT TAPE DISPENSERS

MODEL NO.	DESCRIPTION	FITS TAPE WIDTHS	PRICE EACH	
			1	2+
H-303	3M Filament Dispenser	1/2", 3/4" and 1"	\$54	\$51
H-728	3M Deluxe Filament Dispenser	1/2" and 3/4"	144	135

# ULINE STRAPPING TAPE

FREE Metal Dispenser with  
1 or more cases of Uline Strapping Tape.



## ECONOMY – 100 LB. TENSILE STRENGTH

MODEL NO.	SIZE	ROLLS/CASE	LBS./CASE	PRICE PER ROLL (MIN. 12)				
				12	24	48	72	96+
S-5734	1/2" x 60 yds.	72	14	\$3.00	\$2.50	\$2.05	\$1.95	\$1.80
S-5735	3/4" x 60 yds.	48	15	3.85	3.45	3.05	2.65	2.45
S-5736	1" x 60 yds.	36	14	4.65	4.15	\$3.20 per roll		
S-5737	2" x 60 yds.	24	18	8.55	7.90	6.95	6.65	5.80
S-7180	3" x 60 yds.	12	14	12.25	11.20	10.20	9.60	8.95

**CALL FOR VOLUME PRICING**

**Versatile** – Bundle odd-shaped materials, unitize and seal packages. Secure loose parts during shipment.

## INDUSTRIAL – 170 LB. TENSILE STRENGTH

MODEL NO.	SIZE	ROLLS/CASE	LBS./CASE	PRICE PER ROLL (MIN. 12)				
				12	24	48	72	96+
S-202	1/2" x 60 yds.	72	17	\$3.90	\$3.50	\$2.90	\$2.60	\$2.40
S-203	3/4" x 60 yds.	48	17	4.40	4.00	3.75	3.65	3.25
S-204	1" x 60 yds.	36	17	5.20	4.95	4.50	4.40	4.25
S-511	2" x 60 yds.	24	22	10.00	9.45	\$7.85 per roll		
S-11787	3" x 60 yds.	12	17	15.85	14.75	13.65	13.15	12.30

**Strong** – Glass filaments reinforce tape to give super strength. Superior holding power over twine or glue closures.

## HEAVY DUTY – 300 LB. TENSILE STRENGTH

MODEL NO.	SIZE	ROLLS/CASE	LBS./CASE	PRICE PER ROLL (MIN. 12)				
				12	24	48	72	96+
S-504	1/2" x 60 yds.	72	18	\$5.05	\$4.80	\$4.50	\$4.10	\$3.90
S-505	3/4" x 60 yds.	48	19	6.60	6.25	5.80	5.15	4.85
S-506	1" x 60 yds.	36	19	8.55	7.70	7.25	6.60	6.25
S-513	2" x 60 yds.	24	25	15.60	14.35	13.40	12.70	12.20
S-15777	3" x 60 yds.	12	19	23.55	21.90	20.40	19.15	18.15

**Economy** – Ideal for light-duty applications.

**Industrial** – An economical alternative to plastic or metal strapping.

## AMERICAN RG16

### HEAVY DUTY – 330 LB. TENSILE STRENGTH

MEETS FED. SPEC. ASTM-D5330, TYPE II

MODEL NO.	SIZE	ROLLS/CASE	LBS./CASE	PRICE PER ROLL (MIN. 12)				
				12	24	48	72	96+
S-3302	3/4" x 60 yds.	48	23	\$10.05	\$9.40	\$8.95	\$8.50	\$7.95
S-3303	1" x 60 yds.	36	23	13.05	12.35	11.75	11.20	10.55
S-3304	2" x 60 yds.	24	30	26.10	24.75	23.65	22.35	20.95
S-23593	3" x 60 yds.	16	29	39.15	37.05	35.05	33.30	31.60

**Heavy Duty** – Superior palletizing, bundling and carton sealing strength for your heaviest loads.

## DISPENSERS

- Durable plastic or lifetime guaranteed metal.

MODEL NO.	DESCRIPTION	PRICE EACH	EXTRA BLADES	
H-149	1" Plastic	\$9	H-149B	10 Blades \$20/PKG.
H-108	1" Metal	10	H-108B	20 Blades 22/PKG.
H-380	2" Metal	11	H-380B	10 Blades 20/PKG.
H-1162	3" Metal	15	H-1162B	10 Blades 22/PKG.







# ULINE LABEL PROTECTION TAPE

## LABEL PROTECTION TAPE

MODEL NO.	ROLL SIZE	MIL	ROLLS/CASE	LBS./CASE	PRICE PER ROLL (MIN. 6)				
					6	18	36	72	144+
S-5119	4" x 72 yds.	1.8	18	15	\$4.15	\$3.85	\$3.75	\$3.25	\$3.15
S-216	4" x 72 yds.		18	15	5.30	5.05	4.80	4.55	4.30
S-510	5" x 72 yds.	2.0	12	14	5.80	5.55	5.05	4.80	4.30
S-616	6" x 72 yds.		12	17	7.05	6.55	6.05	5.55	5.30

Securely attaches labels and documents to paper, wood, metal or plastic.

- Crystal clear non-yellowing acrylic adhesive.
- Covers approximately 400 labels per roll.

## DISPENSERS

MODEL NO.	DESCRIPTION	WT. (LBS.)	PRICE EACH			
			1	2	6	10+
H-102	4" Table Model	2	\$27	\$26	\$24	\$22
H-98	6" Table Model	3	33	31	28	26

## ULINE POUCH TAPE



Attach packing lists to shipments for less.

- Protect against moisture, tearing and smudging.
- Adhesive on all four edges with an adhesive-free center.

MODEL NO.	DESCRIPTION	COLOR	OUTSIDE DIM.	MIL	ROLLS/CASE	QTY./ROLL	PRICE PER ROLL		
							1	8	24+
S-2278 S-3057	Packing List Enclosed	Orange Blue	5 x 6"	2.0	12	500	\$30	\$27	\$25

## 3M POUCH TAPE

3M 828 Rolls – See-through pouch with red adhesive border attaches in one step.

3M 8240 and 3M 827 Rolls – "Super Stick" orange border features quality 3M adhesive.



MODEL NO.	STYLE	DESCRIPTION	OUTSIDE DIM.	MIL	ROLLS/CASE	QTY./ROLL	PRICE PER ROLL		
							1	8	24+
S-1840	3M 828	Packing List Encl.	5 x 6"		8	666	\$100	\$94	\$90
S-493 S-571	3M 8240 3M 827	Documents Enclosed	5 x 6" 5 x 8"	2.5	8	500	73 94	68 90	63 83

## BIG DADDY/BIG MAMA



MULTI-CORE DISPENSER



BIG MAMA – 1.5" CORE



BIG DADDY – 3" CORE

Use with Big Daddy or Big Mama. Holds 1½" core rolls or use 3" core attachment.

**FREE H-813 MULTI-CORE DISPENSER WITH 36+ ROLLS**

Same amount of tape as Uline's Big Daddy, but **less bulky**.

- Compact 1½" core allows for easier handling.
- Quality solvent acrylic adhesive.

Seals four times as much as 55-yd. rolls. Reduces downtime caused by changing rolls.

- Solvent acrylic adhesive.



BIG DADDY    BIG MAMA    REGULAR

MODEL NO.	DESCRIPTION	COLOR	SIZE	MIL	LBS./CASE	PRICE PER ROLL (36 ROLLS PER CASE)			
						18	36	72	144+
S-472 S-471	Big Daddy	Clear Tan	2" x 220 yds.	2.0	42	\$6.30	\$5.55	\$4.90	\$4.45
S-5355	Big Mama	Clear	2" x 220 yds.	2.0	46	6.55	5.80	5.30	4.80
H-813	2-in-1 Dispenser		\$15 each		H-813B	Extra Blades \$13/pkg. of 10			



# ULINE QUIET TAPE

MODEL NO.	SIZE	MIL	ROLLS/CASE	PRICE PER ROLL		
				1/2 CS.	1 CS.	2+ CS.
S-15564	2" x 110 yds.	2.0	36	\$5.25	\$5.00	\$4.75
S-15565	3" x 110 yds.			6.50	6.25	6.00
S-14576	2" x 55 yds.	2.6	36	4.00	3.75	3.25
S-16984	2" x 110 yds.			6.25	6.00	5.50
S-14577	3" x 55 yds.	2.6	24	5.75	5.50	5.00
S-16985	3" x 110 yds.			9.00	7.75	7.25
S-14578	2" x 55 yds.	3.1	36	5.00	4.50	4.25
S-14579	3" x 55 yds.			7.00	6.50	6.00



A true noiseless tape for offices and mailrooms.

- Unwinds like butter. • Meets USPS and UPS regulations.
- Solvent acrylic adhesive with easy-release coating.

## QUIET TAPE WITH DISPENSER



Compact, all-in-one solution for mailrooms and department store stockrooms.

- Built-in dispenser for smooth sealing. Resists tearing.
- Solvent acrylic adhesive with easy-release coating.
- Noiseless. Unwinds like butter.

26 LB. TENSILE STRENGTH

SOLD IN CASE QUANTITIES

MODEL NO.	SIZE	MIL	ROLLS/CASE	PRICE PER ROLL			
				12	24	36	72+
S-25180	2" x 22 yds.	2.6	12	\$3.10	\$2.85	\$2.70	\$2.60

## MAGNETIC TAPE DISPENSER

Magnetic mount. This tape dispenser is a shipper's best friend.

- Adjustable brake for tension control.
- Retractable safety blade protects from cuts.
- Extra blades, see uline.com



MODEL NO.	DESCRIPTION	PRICE EACH			
		1	2	6	10+
H-8648	2" Dispenser with Magnet	\$28	\$26	\$24	\$22
H-9433	3" Dispenser with Magnet	36	34	32	30

## TESA STRAPPING TAPE

NO FILAMENTS

Secure your pallets or packages with heavy-duty polypropylene tape.

- Stretches over 35% before breaking, yet snaps back to hold shifting loads tightly. Natural rubber adhesive.

**4288/4092** – Use for banding, bundling and palletizing.

**4298** – Secure appliances and furniture. Removes cleanly.

**4289** – Bundle and secure heavy steel pipes. Removes cleanly.



4288/4092 – 145 LB. TENSILE STRENGTH

MODEL NO.	SIZE	MIL	ROLLS/CASE	LBS./CASE	PRICE PER ROLL (MIN. 12)		
					12	36	72+
S-2056	3/8" x 60 yds.		192	24	\$1.75	\$1.60	\$1.50
S-375	1/2" x 60 yds.		144	25	2.15	1.85	1.75
S-376	3/4" x 60 yds.	4.0	96	24	3.00	2.90	2.60
S-382	1" x 60 yds.		72	25	3.85	3.50	3.25
S-19029	2" x 60 yds.		36	24	8.25	7.50	6.85

4298 – 163 LB. TENSILE STRENGTH

SPECIFY COLOR: Blue or Ivory

MODEL NO.	SIZE	MIL	ROLLS/CASE	LBS./CASE	PRICE PER ROLL (MIN. 6)		
					6	12	36+
S-19030	3/4" x 60 yds.		96	27	\$7.90	\$7.25	\$6.45
S-19031	1" x 60 yds.	4.5	72	28	10.45	9.50	8.65
S-19032	2" x 60 yds.		36	28	20.70	19.65	18.50

4289 – 214 LB. TENSILE STRENGTH

MODEL NO.	SIZE	MIL	ROLLS/CASE	LBS./CASE	PRICE PER ROLL (MIN. 6)		
					6	12	36+
S-23642	1/2" x 60 yds.		144	32	\$6.05	\$5.75	\$5.35
S-23643	1" x 60 yds.	5.9	72	31	13.15	12.50	11.80

# DOUBLE DUTY TAPE

Get your message across as you seal your packages.

- Strong, waterproof 2.2 mil polypropylene tape.
- Reduce downtime with 110 yard rolls.
- 3" tape seals cartons in one pass.



2" x 55 yds. S-3786    2" x 110 yds. S-14465    3" x 110 yds. S-5728



2" x 55 yds. S-735    2" x 110 yds. S-5144    3" x 110 yds. S-14466



2" x 55 yds. S-732    2" x 110 yds. S-14467    3" x 110 yds. S-9777



2" x 55 yds. S-2218    2" x 110 yds. S-9776    3" x 110 yds. S-14468



2" x 55 yds. S-9864    3" x 110 yds. S-13482



2" x 55 yds. S-3340    2" x 110 yds. S-14469    3" x 110 yds. S-14470



2" x 55 yds. S-731    3" x 110 yds. S-5729



2" x 110 yds. S-18986



2" x 55 yds. S-730



2" x 55 yds. S-3343



2" x 110 yds. S-1843



2" x 55 yds. S-3787



2" x 110 yds. S-18987



2" x 55 yds. S-11662



2" x 55 yds. S-11663

ROLL SIZE	MIL	ROLLS/CTN.	LBS./CTN.	PRICE PER ROLL (MIN. 18)			
				18	36	72	180+
2" x 55 yds.	2.2	36	14	\$3.30	\$3.10	\$2.95	\$2.75
2" x 110 yds.		36	23	6.05	5.80	5.55	5.05

ROLL SIZE	MIL	ROLLS/CTN.	LBS./CTN.	PRICE PER ROLL (MIN. 24)			
				24	48	72	144+
3" x 110 yds.	2.2	24	23	\$8.55	\$8.05	\$7.55	\$7.05



2" x 110 yds. S-1921



2" x 55 yds. S-3342

# CUSTOM PRINTED SEALING TAPE

Advertise your company name and protect your packages with custom printed tape. Most messages repeat every 6" for over 300 messages per roll.

## PVC TAPE

- Quiet release and smooth unwind.
- For bold graphics and solid colors.

## POLYPROPYLENE TAPE

- Save up to 25% with custom poly.
- Crisp, clear imprints for detailed logos.
- 110 yd. rolls reduce downtime caused by changing rolls.

### ORDERING INFORMATION:

- Choose tape and color.
- Choose ink color: Black, Blue, Red, Brown or Green.
- Design online and upload or email your artwork, see [uline.com](http://uline.com)
- One-time \$50 plate charge per order.
- Please allow 3 weeks for delivery.
- 2-color printing – Add 15% to cost of rolls. 2 case minimum. \$65 plate charge.



### PVC

\* Minimum 24 rolls

MODEL NO.	TAPE COLOR	SIZE	MIL	ROLLS/CASE	PRICE PER ROLL				
					18-24	36	72	180	360+
S-2585	Tan, White and Clear	2" x 55 yds.	2.2	36	\$10.00	\$8.95	\$8.00	\$7.10	\$6.15
S-5260		2" x 110 yds.		36	15.15	14.00	12.85	11.10	9.55
S-2587*		3" x 55 yds.		24	13.25	11.95	11.00	9.30	8.05
S-14535	Yellow, Orange, Blue, Red, Green	2" x 55 yds.	3.2	36	N/A	12.30	11.00	9.80	8.80
S-14536		2" x 110 yds.		36	N/A	17.50	16.10	15.65	14.00
S-14537*		3" x 55 yds.		24	18.15	17.15	15.75	14.10	12.70
S-2586	Yellow, Orange, Blue, Red, Green	2" x 55 yds.	2.2	36	10.85	9.45	8.40	7.40	6.55
S-5261		2" x 110 yds.		36	18.20	16.95	15.85	13.70	12.50
S-2588*		3" x 55 yds.		24	15.20	14.10	12.85	11.50	10.15

### POLYPROPYLENE

MODEL NO.	TAPE COLOR	SIZE	MIL	ROLLS/CASE	PRICE PER ROLL				
					24	36	72	180	360+
S-3360	Tan, White and Clear	2" x 55 yds.	2.0	36	N/A	\$5.95	\$4.95	\$4.40	\$3.75
S-3361		2" x 110 yds.		36	N/A	8.75	7.75	6.95	6.05
S-3362		3" x 55 yds.		24	\$8.75	N/A	7.20	6.45	5.20
S-5162		3" x 110 yds.		24	12.30	N/A	10.75	9.70	8.45
S-14539		2" x 110 yds.		36	N/A	10.30	8.90	7.90	7.00
S-8299	Red, Yellow	2" x 110 yds.	2.0	36	N/A	9.05	7.95	7.15	6.30

# COLOR CODED CARTON SEALING TAPE

2.2 MIL

Prevent mix-ups and keep your packages clearly identified for shipment or delivery.

- Mark 2nd Day UPS cartons with Blue; Federal Express packages with Red; Green identifies First Class Mail; etc.
- Strong solvent acrylic adhesive sticks to virtually any surface.
- Ideal for dating inventory, product coding and warehouse location.
- Machine length rolls available, see page 845.



Specify Green, Red, Purple, Orange, Yellow, Blue, White or Black when ordering. Colors combinable within one size.



Minimum 18 rolls

MODEL NO.	SIZE	MIL	ROLLS/CASE	PRICE PER ROLL			
				18	36	72	144+
S-700	2" x 55 yds.	2.2	36	\$3.15	\$2.85	\$2.65	\$2.40
S-3757	2" x 110 yds.		36	5.05	\$3.60 per roll		
S-2051	3" x 55 yds.		24	4.15	3.70	3.45	3.20



# NATURAL RUBBER ADHESIVE TAPE



## POLYPROPYLENE

**INDUSTRIAL**

Handles your most difficult "problem cartons."

- Economical polypropylene backing with natural rubber adhesive.
- Instantly grips recycled, used or rough surface corrugated.
- Withstands extreme temperatures of 0° to 150°F.

MODEL NO.	COLOR	SIZE	MIL	RLS./CASE	LBS./CASE	PRICE PER ROLL			
						24-36	72	144	288+
S-6531	Clear	2" x 110 yds.	1.7	36	20	\$3.95	\$3.55	\$3.05	\$2.80
S-6532		3" x 110 yds.		24		6.00	5.55	4.60	4.35
S-6533	Clear	2" x 110 yds.	2.0	36	22	<b>\$3.05 per roll any case qty.</b>			
S-6534		3" x 110 yds.		24					
S-6535	Clear	2" x 110 yds.	2.5	36	26	4.70	4.25	3.60	3.45
S-6536		3" x 110 yds.		24		7.15	6.60	5.55	5.15
S-12878	Clear	2" x 55 yds.	3.0	36	16	4.55	4.10	3.45	3.20
S-12879		3" x 55 yds.		24		6.75	6.20	5.10	4.75



## PVC

**DELUXE**

**No annoying tape chatter.** Smooth, quiet, even application.

- Strong polyvinyl chloride film backing – Less stretch, maximum tear and puncture resistance.
- Natural rubber-based adhesive grips instantly, even in cold or humid conditions 0° to 150°F.
- Meets UPS, U.S. Postal Service, Freight Rule 222 and RR Carload requirements.

MODEL NO.	COLOR	SIZE	MIL	RLS./CASE	LBS./CASE	PRICE PER ROLL (MIN. 18)			
						18	36	72	180+
S-660	Clear Tan	2" x 55 yds.	2.2	36	10	\$4.20	<b>\$3.15 per roll</b>		
S-661									
S-662	Clear Tan	2" x 110 yds.	2.2	36	25	7.85	6.90	6.10	5.50
S-663									
S-664	Clear Tan	3" x 110 yds.	2.2	24	25	11.25	10.40	10.00	9.40
S-665									



## SILENT POLYPROPYLENE

**LOW NOISE**

Eliminate the warehouse racket.

- Natural rubber adhesive with special release coat provides exceptionally smooth, low noise unwind.
- Reliable, all temperature performance. • Works with any tape dispenser.

MODEL NO.	COLOR	SIZE	MIL	RLS./CASE	LBS./CASE	PRICE PER ROLL (MIN. 18)			
						18	36	72	180+
S-7593	Clear	2" x 110 yds.	2.2	36	22	\$4.70	\$4.40	\$4.15	\$4.00
S-7842		3" x 110 yds.				24	7.05	6.75	6.45

## SECURITY STRIPS ON A ROLL



Guards against theft and provides clear evidence of tampering.

- Sequentially numbered to identify, track packages.
- "OPENED VOID" message appears if tape is lifted.



Security Tape, see page 834.

SPECIFY COLOR: Red or Blue

MODEL NO.	SIZE	MIL	STRIPS/ROLL	LBS./CASE	PRICE PER ROLL (24 ROLLS/CASE)			
					1	6	24	48+
S-16981	2 x 5 3/4"	3.9	330	17	\$44	\$41	\$38	\$36

## ULINE FOLDING KNIFE



Compact utility knife safely folds to fit in your pocket.

- Quick blade changes – Push-button release.
- Includes 1 blade.

SPECIFY COLOR: Red, Blue, Black or Silver

MODEL NO.	PRICE EACH (MIN. 6)				H-64B EXTRA BLADES
	6	12	24	48+	
H-2755	\$8.00	\$7.75	\$7.50	\$7.20	\$18 100/pk.

# ULINE MACHINE LENGTH TAPE

MODEL NO.	DESCRIPTION	SIZE	MIL	ROLLS/CASE	LBS./CASE	PRICE PER ROLL (MIN. 1 CASE)			
						4-6	12	24	48+
S-7818	Clear	2" x 1,000 yds.	1.7	6	24	\$22	\$19	\$18	CALL FOR QUOTE
S-5566		2" x 1,000 yds.	2.0	6	30	\$19/roll any case qty.			
S-12914		2" x 1,500 yds.		6	42	33	31	29	
S-14732		2" x 2,000 yds.		4	36	43	41	37	
S-7203		3" x 1,000 yds.		4	28	33	31	29	
S-7819		2" x 1,000 yds.	2.5	6	36	35	33	31	
S-14733		3" x 1,000 yds.		4	36	55	51	46	
S-14734		2" x 1,000 yds.	3.0	6	42	51	47	43	



Tough polypropylene backing resists tears and splits. Smooth, easy release.

- Hot melt adhesive.

**Cold Temp** – Sticks tight in cold, damp conditions down to -40°F.

## COLD TEMP

MODEL NO.	DESCRIPTION	SIZE	MIL	ROLLS/CASE	LBS./CASE	PRICE PER ROLL (MIN. 1 CASE)			
						6	12	24	48+
S-24397	Clear	2" x 1,000 yds.	1.7	6	24	\$34	\$32	\$30	CALL
S-24398			2.0			37	34	32	

## COLOR CODED

SPECIFY COLOR: Red, Blue, White, Green, Yellow or Orange

MODEL NO.	DESCRIPTION	SIZE	MIL	ROLLS/CASE	LBS./CASE	PRICE PER ROLL (MIN. 1 CASE)			
						6	12	24	48+
S-17270	Specify	2" x 1,000 yds.	1.9	6	27	\$48	\$46	\$43	CALL

**Color Coded** – Identify packages for delivery or inventory. Available in 6 hot colors.



## 3M DISPENSERS

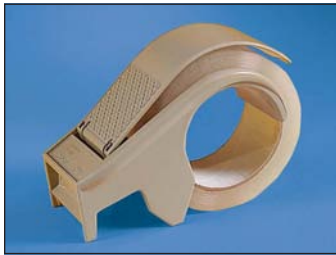

H-304 LIGHTWEIGHT



H-399 ERGONOMIC



H-2960 RETRACTABLE BLADE



H-729, H-730 PISTOL GRIP

MODEL NO.	DISPENSER	DESCRIPTION	PRICE EACH		
			1	2	5+
H-304	3M H122	2" Lightweight	\$68	\$67	\$66
H-399	3M H190	3" Ergonomic	31	29	27
H-2960	3M HR933	3" Retractable Blade	59	58	57
H-729	3M H180	2" Pistol Grip	59	58	57
H-730	3M H183	3" Pistol Grip	103	98	96

**Lightweight** – Half the weight of other dispensers.

**Ergonomic** – Designed to minimize wrist fatigue.

**Retractable Blade** – Prevents accidental cuts. 3" wide.

**Pistol Grip** – Convenient side loader with adjustable tape brake.

## SPECIALTY DISPENSERS

MODEL NO.	DISPENSER	DESCRIPTION	PRICE EACH			
			1	2	3	5+
H-567	Economy	2" Spring-Loaded	\$14	\$13	\$12	\$11
H-3975		3" Spring-Loaded	24	23	22	21
H-466	Light Duty	2" Lightweight	17	16	15	14
H-674	Safety	2" Retractable Blade	20	19	18	17
H-932		3" Retractable Blade	26	25	23	22

**Economy** – Lightweight. Fits 1-3" cores.

**Light Duty** – Holds 3" core tape.

**Safety** – Prevents nicks and cuts.



H-674, H-932 RETRACTABLE SAFETY BLADE



RETRACTABLE BLADE



H-466 LIGHT DUTY



H-567, H-3975 ECONOMY



## 3M 371 CARTON SEALING TAPE

**BEST SELLER**

The best-selling tape in the U.S.

- Known for its **consistent hot melt adhesive**. Won't peel, crack or dry out.
- Waterproof and weatherproof. • 22 lb. tensile strength.

MODEL NO.	COLOR	SIZE	MIL	ROLLS/CASE	LBS./CASE	PRICE PER ROLL (MIN. 18)				
						18	36	72	144	288+
S-746	Clear	2" x 55 yds.	1.8	36	11	\$4.45	\$3.90	\$3.70	\$3.15	\$2.90
S-1871	Clear	3" x 55 yds.		24	11	7.60	7.10	6.45	5.45	4.90
S-749	Clear	2" x 110 yds.		36	21	5.85	\$3.10 per roll			
S-1873	Clear	3" x 110 yds.		24	21	6.95	6.45	5.80	4.80	4.35



## 3M 373

**SUPER DUTY**

Thick and strong. Seals boxes in one pass.

- Saves time and money. • Eliminates use of multiple pieces of tape.
- Tough Scotchpro™ backing won't tear or split. • 30 lb. tensile strength.

MEETS FED. SPEC. CID A-A-1684B

MODEL NO.	COLOR	SIZE	MIL	ROLLS/CASE	LBS./CASE	PRICE PER ROLL (MIN. 1 CASE)			
						24	36	72	144+
S-5741	Clear	2" x 55 yds.	2.5	36	14	N/A	\$10.45	\$9.95	\$9.20
S-5743		3" x 55 yds.		24	13	\$16.00	14.75	13.90	13.05
S-5742	Clear	2" x 110 yds.		36	24	N/A	18.00	16.45	16.05
S-5744		3" x 110 yds.		24	24	27.85	26.45	25.05	24.05



## 3M MACHINE LENGTH TAPE

**HIGH VOLUME**

Tough poly backing resists tears and splits.

- Hot melt adhesive. • Smooth, easy release.
- For machine use only. Not compatible with handheld dispensers.

MODEL NO.	DESC.	SIZE	MIL	ROLLS/CASE	LBS./CASE	PRICE PER ROLL (MIN. 1 CASE)			
						4-6	12	24	48+
S-1833		2" x 1,000 yds.	1.8	6	27	\$28	\$26	\$25	CALL FOR QUOTE
S-11910	3M 371	2" x 1,640 yds.		6	45	53	50	49	
S-11909		3" x 1,000 yds.		4	28	47	46	44	
S-23027	3M 371+	2" x 1,000 yds.	1.9	6	30	34	31	30	
S-10153	3M 373	2" x 1,000 yds.	2.5	6	35	126	118	112	
S-10154		3" x 1,000 yds.		4	37	199	184	176	
S-7821	3M 375	2" x 1,000 yds.	3.0	6	42	202	196	192	
S-15005		3" x 1,000 yds.		4	43	317	310	300	

MODEL NO.	DESC.	SIZE	MIL	ROLLS/CASE	LBS./CASE	PRICE PER ROLL (MIN. 1 CASE)			
						2-4	8	12+	48+
S-10174	3M 355	2" x 1,000 yds.	3.5	4	43	\$298	\$284	\$273	CALL FOR QUOTE
S-15952		3" x 1,000 yds.		2	32	428	414	387	

**3M 371** – The best-selling tape in the U.S.

**3M 371+** – Bonds instantly to recycled corrugated cartons.

**3M 373** – Thick and strong. Seal boxes in one pass.

**3M 375** – You'll never have to worry about your packages being absolutely, positively sealed tight.

**3M 355** – Recommended for international shipments.



## 3M 375

### TOP OF THE LINE

Top-of-the-line 3M carton sealing tape. You'll never have to worry about your packages being **absolutely, positively sealed tight**.

- Quality backing resists splitting and guarantees long-term durability.
- 35 lb. tensile strength.

MODEL NO.	COLOR	SIZE	MIL	ROLLS/CASE	LBS./CASE	PRICE PER ROLL			
						18-24	36	72	144+
S-1034	Clear	2" x 55 yds.	3.1	36	20	\$12.20	\$9.80 per roll		
S-1836	Clear	3" x 55 yds.		24	15	18.00	16.90	16.15	15.30



## 3M 355

### TOUGHEST GUY ON THE BLOCK

Recommended for international shipments and extra-heavy packages.

- Tough polyester backing protects your valuable packages.
- Secures cartons weighing up to 150 lbs. • 67 lb. tensile strength.

MEETS MIL SPEC. ASTM D5486 TYPE I AND II

MODEL NO.	COLOR	SIZE	MIL	ROLLS/CASE	LBS./CASE	PRICE PER ROLL (MIN. 6)			
						6	18	36	72+
S-7591	Clear	2" x 55 yds.	3.5	36	24	\$20.80	\$20.05	\$19.65	\$18.70
S-7655	Clear	3" x 55 yds.		24		30.55	29.25	28.85	27.55



## 3M 371+

### RECYCLED CARTONS

Bonds instantly to **recycled corrugated cartons**.

- Strong, conformable backing resists splitting or tearing. Unwinds easily.
- S-23027 Machine Length – For use with automated case sealers.

3M 371+ – 22 lb. tensile strength.

MODEL NO.	COLOR	SIZE	MIL	ROLLS/CASE	LBS./CASE	PRICE PER ROLL				
						24	36	72	144	288+
S-23026	Clear	2" x 110 yds.	1.9	36	18	\$5.55	\$3.10 per roll			
						6	12	24	48	96+
S-23027	Clear	2" x 1,000 yds.	1.9	6	30	\$34.00	\$31.00	\$30.00 per roll		



## 3M 305, 311+, 313

### ACRYLIC ADHESIVE

Acrylic adhesive performs in a wide temperature range: 32° to 120°F.

- Resists UV rays without yellowing. • Crystal clear appearance keeps packages looking nice.
- Instantly sticks to corrugated.

3M 305 – 21 lb. tensile strength.

MODEL NO.	COLOR	SIZE	MIL	ROLLS/CASE	LBS./CASE	PRICE PER ROLL			
						24-36	72	144	288+
S-6725	Clear	2" x 110 yds.	1.8	36	19	\$3.35	\$2.30 per roll		
S-6726		3" x 110 yds.		24		4.65	4.25	4.05	3.95

3M 311+ – 25 lb. tensile strength.

MODEL NO.	COLOR	SIZE	MIL	ROLLS/CASE	LBS./CASE	PRICE PER ROLL			
						24-36	72	144	288+
S-6727	Clear	2" x 110 yds.	2.0	36	21	\$4.00	\$2.50 per roll		
S-6728		3" x 110 yds.		24		7.75	6.45	5.35	4.70

3M 313 – 35 lb. tensile strength.

MODEL NO.	COLOR	SIZE	MIL	ROLLS/CASE	LBS./CASE	PRICE PER ROLL			
						24-36	72	144	288+
S-7844	Clear	2" x 110 yds.	2.5	36	27	\$7.70	\$6.45	\$5.35	\$4.70
S-7845		3" x 110 yds.		24		11.75	9.90	8.10	7.05



3M 305



3M 313



3M 311+

# ULINE TAPE DISPENSERS

## TOP GUN

Truly the Cadillac of tape dispensers.

- More than **1/2 lb. lighter** than ordinary dispensers.
- **Side loading** makes changing rolls quick and easy.
- Adjustable brake provides the tension you need.
- Handles are specially designed with extra comfortable grips.

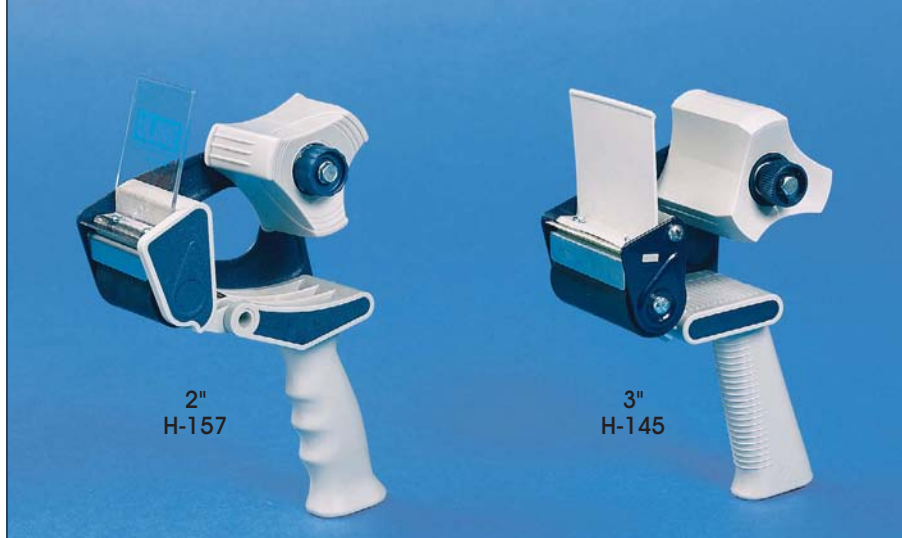

MODEL NO.	DESCRIPTION	PRICE EACH				EXTRA BLADES	
		1	2	6	10+		
H-157	2" Top Gun	<b>\$12 each any quantity</b>				H-157B	\$13/PKG. OF 10
H-145	3" Top Gun	\$33	\$29	\$24	\$21	H-145B	\$16/PKG. OF 10

## HEAVY DUTY

Durable, solid steel frame withstands even the roughest abuse.

- **Natural rubber roller** holds tape in place when dispensing.
- Italian made, superior construction.
- Adjustable brake for tension control.

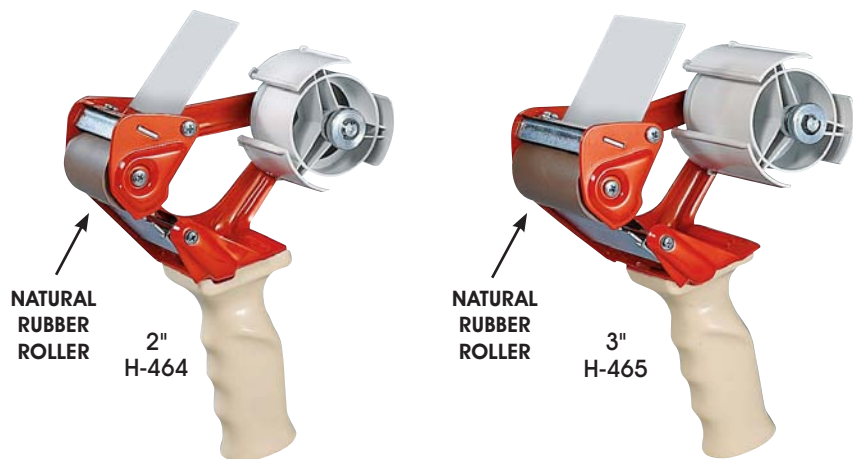

MODEL NO.	DESCRIPTION	PRICE EACH				EXTRA BLADES	
		1	2	6	10+		
H-464	2" Heavy Duty	\$19	\$18	\$16	\$14	H-464B	\$19/PKG. OF 5
H-465	3" Heavy Duty	30	27	25	22	H-465B	\$24/PKG. OF 5



SPECIFY COLOR: Orange Lime Green

## INDUSTRIAL

### SIDE LOADER

- Quick side loading dispenser.
- Adjustable brake to control tension.

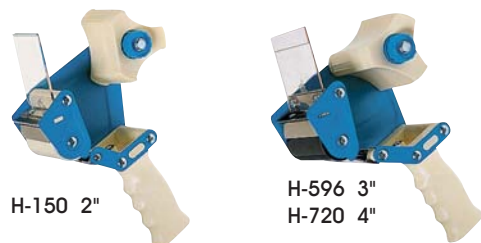

MODEL NO.	DESCRIPTION	PRICE EACH				EXTRA BLADES	
		1	2	6	10+		
H-150	2" Side Loader	\$12	\$11	\$10	\$9	H-150B	\$13/PKG. OF 10
H-596	3" Side Loader	20	19	17	15	H-596B	\$16/PKG. OF 10
H-720	4" Side Loader	31	29	26	22	H-720B	\$20/PKG. OF 10

### TOP LOADER

- Sturdy side plates protect from abuse.
- Smooth tape application.

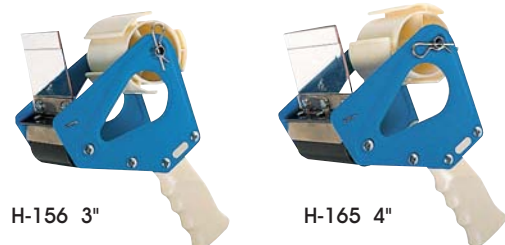

MODEL NO.	DESCRIPTION	PRICE EACH				EXTRA BLADES	
		1	2	6	10+		
H-156	3" Top Loader	\$22	\$21	\$19	\$17	H-156B	\$16/PKG. OF 10
H-165	4" Top Loader	35	32	29	26	H-165B	\$20/PKG. OF 10



**1.7 MIL**

MODEL NO.	COLOR	SIZE	ROLLS/CASE	LBS./CASE	PRICE PER ROLL (MIN. 1 CASE)				
					24-36	72	144	360	
S-2785 S-3257	Clear Tan	2" x 55 yds.	36	10	\$2.05	\$1.95	\$1.80	\$1.55	CALL FOR QUOTE
S-2786 S-5342	Clear Tan	2" x 110 yds.	36	18	3.00	\$2.35 per roll			
S-2788	Clear	3" x 110 yds.	24	22	4.30	4.10	3.80	3.50	

**2.0 MIL**

S-3258 S-3266	Clear Tan	2" x 55 yds.	36	12	\$2.15	\$2.05	\$1.95	\$1.65	CALL FOR QUOTE
S-3267 S-5343	Clear Tan	2" x 110 yds.	36	22	3.05	\$2.60 per roll			
S-3268	Clear	3" x 110 yds.	24	22	5.45	4.95	4.50	3.95	

**2.5 MIL**

S-3827 S-5738	Clear Tan	2" x 55 yds.	36	14	\$3.90	\$3.25	\$2.65	\$2.25	CALL FOR QUOTE
S-2789 S-5739	Clear Tan	2" x 110 yds.	36	26	6.60	5.50	4.70	3.85	
S-3269	Clear	3" x 110 yds.	24	26	7.90	6.60	6.05	5.35	

**3.0 MIL**

S-2790 S-5740	Clear	2" x 55 yds. 3" x 55 yds.	36 24	16 16	\$4.50 6.80	\$4.20 6.25	\$3.55 5.20	\$2.75 4.10	CALL
------------------	-------	------------------------------	----------	----------	----------------	----------------	----------------	----------------	------

**3.5 MIL**

S-9735 S-9736	Clear	2" x 55 yds. 3" x 55 yds.	36 24	20 20	\$5.05 7.45	\$4.65 6.80	\$4.15 6.10	\$3.45 5.10	CALL
------------------	-------	------------------------------	----------	----------	----------------	----------------	----------------	----------------	------

As low as \$1.55 per roll

**SAVE UP TO 50%  
OVER BRAND NAME TAPES**

**QUICK STICK:** Aggressive hot melt adhesive instantly sticks to corrugated cartons.

**BURST PROOF:** Seals tight so your packages stay protected.

**EASY RELEASE:** Dispenses quickly. Seal more cartons in less time.

**VERSATILE:** Performs in temperatures of 30° to 140°F.

**ULINE WAREHOUSE WORK BELT**

High quality, durable nylon work belt includes tape gun holster and knife/pen pouch.

- Knife Utility Pouch – Three elastic pockets for small tools.
- All-in-One Pouch – Three pockets hold tape gun, knives, pens, labels and packing lists.

MODEL NO.	DESCRIPTION	PRICE EACH		
		1	12	24+
H-463	Warehouse Work Belt	\$49	\$47	\$45
H-724	Knife Utility Pouch	19	18	17
H-1367	All-in-One Pouch	41	39	38

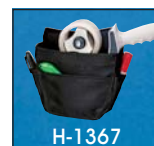
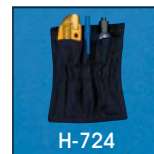

Waist adjustable up to 50"



# ULINE INDUSTRIAL TAPE



## 1.8 MIL

- Quality acrylic adhesive tape for **as low as \$1.35 per roll.**
- Recommended for lightweight packages under 40 lbs.
- 16 lbs. per inch tensile strength.

## ECONOMY

MODEL NO.	COLOR	MIL	SIZE	ROLLS/CASE	LBS./CASE	PRICE PER ROLL (SOLD IN CASE QUANTITIES)				
						1 CASE	2 CASES	4 CASES	10 CASES	20+ CS.
S-117	Clear	1.8	2" x 55 yds.	36	12	\$1.60	\$1.55	\$1.45	\$1.35	CALL FOR QUOTE
S-116	Tan									
S-119	Clear	1.8	2" x 110 yds.	36	22	2.55	\$1.90 per roll			
S-118	Tan									
S-2325	Clear	1.8	3" x 110 yds.	24	22	3.80	3.55	3.35	3.05	
S-2324	Tan									

## 2.6 MIL

- Tough solvent acrylic adhesive for a secure hold.
- Recommended for use on shipments **over 40 lbs.**
- 26 lbs. per inch tensile strength.
- Free Uline side load dispenser with an order of one case or more.

## INDUSTRIAL PLUS

HIGHLY RECOMMENDED

MODEL NO.	COLOR	MIL	SIZE	ROLLS/CASE	LBS./CASE	PRICE PER ROLL				
						18-24	36	72	144	288+
S-672	Clear	2.6	2" x 55 yds.	36	16	\$3.30	\$3.10	\$2.70	\$2.35	\$2.00
S-673	Tan									
S-743	Clear	2.6	2" x 110 yds.	36	26	5.60	5.40	4.55	4.10	3.45
S-1766	Tan									
S-1893	Clear	2.6	3" x 55 yds.	24	16	4.65	4.50	4.10	3.70	3.30
S-1894	Tan									
S-5332	Clear	2.6	3" x 110 yds.	24	26	7.55	6.55	6.30	6.05	5.55
S-5333	Tan									

## 3.5 MIL



## HEAVY DUTY

- Thickest, strongest Uline brand tape.
- For UPS oversize shipments and packages **over 60 lbs.**
- 40 lbs. per inch tensile strength.
- Free Uline side load dispenser with an order of one case or more.

MODEL NO.	COLOR	MIL	SIZE	ROLLS/CASE	LBS./CASE	PRICE PER ROLL				
						18-24	36	72	144	288+
S-447	Clear	3.5	2" x 55 yds.	36	20	\$4.20	\$3.85	\$3.55	\$3.25	\$2.70
S-448	Tan									
S-1850	Clear	3.5	3" x 55 yds.	24	19	5.70	5.55	5.30	4.80	4.10
S-1851	Tan									



## ULINE INDUSTRIAL TAPE

**2.0 MIL**

Our best-selling tape. Strong solvent acrylic adhesive sticks to virtually any surface.

**DURABLE:** Industrial Tape stands up to heat, humidity and cold. Application range 0° to 140°F.

**RELIABLE:** Long shelf life. Meets UPS and U.S. Postal Regulations.

**APPEARANCE:** Crystal clear – Won't yellow. Makes packages look their best.

*"We don't mess with cheaper tape because in the end you use more tape and it's more work."*

Alex Schmidt – Uline UPS Line Manager

20 LBS. PER INCH TENSILE STRENGTH

MODEL NO.	COLOR	MIL	SIZE	ROLLS/CASE	LBS./CASE	PRICE PER ROLL				
						18	36	72	144	288+
S-200	Clear	2.0	2" x 55 yds.	36	12	\$2.35	\$2.05	\$1.85	\$1.65	\$1.45
S-201	Tan									
S-423	Clear	2.0	2" x 110 yds.	36	22	3.95	<b>\$2.20 per roll</b>			
S-422	Tan									
S-472	Clear	2.0	2" x 220 yds.	36	42	6.30	5.55	4.90	4.45	4.25
S-471	Tan									
						24	48	72	144	288+
S-445	Clear	2.0	3" x 110 yds.	24	22	\$4.90	<b>\$3.45 per roll</b>			
S-444	Tan									
S-216	Clear	2.0	4" x 72 yds.	18	15	5.05	4.80	4.55	4.30	4.05



FREE ULINE SIDE LOAD DISPENSER WITH ORDER OF 1 CASE OR MORE

## 3" INDUSTRIAL TAPE

Uline packages your shipments with 3" tape.

- Seal a carton in one pass with 3" extra-wide industrial rolls.
- Strong solvent acrylic adhesive sticks to virtually every surface.
- Free H-596 dispenser with 24+ rolls.

MODEL NO.	COLOR	MIL	SIZE	ROLLS/CASE	LBS./CASE	PRICE PER ROLL (MIN. 24)										
						24	48	72	144	288+						
S-445	Clear	2.0	3" x 110 yds.	24	22	\$4.90	<b>\$3.45 per roll</b>									
S-1893		2.6	3" x 55 yds.								16	4.65	\$4.50	\$4.10	\$3.70	\$3.30
S-1850		3.5	3" x 55 yds.													

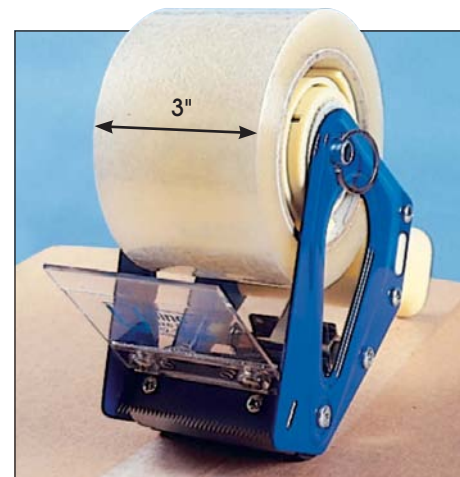

## 1. SOLD TO:

Uline Cust. # \_\_\_\_\_ (Yellow Box / Back Cover)  
 P.O. Number \_\_\_\_\_  
 Company Name \_\_\_\_\_  
 Buyer's Name/Title \_\_\_\_\_  
 Street Address \_\_\_\_\_  
 City/State/Zip \_\_\_\_\_  
 Phone \_\_\_\_\_ Fax \_\_\_\_\_  
 Email \_\_\_\_\_

## 2. SHIP TO: If different than "Sold To"

Company Name \_\_\_\_\_  
 Contact/Title \_\_\_\_\_  
 Street Address \_\_\_\_\_  
 City/State/Zip \_\_\_\_\_

**PHONE** 1-800-295-5510 FAX: 1-800-295-5571

**EMAIL** [customer.service@uline.com](mailto:customer.service@uline.com)

**WEBSITE** [uline.com](http://uline.com). Order, check monthly specials and review your purchase history online.

**FREE OFFERS** See pages 864-867, 862.

**HOURS** 24 hours a day, 7 days per week – call us to place an order.

## 3. ORDER INFORMATION:

QTY.	MODEL NUMBER	DESCRIPTION (Include size/color if applicable)	UNIT PRICE	TOTAL PRICE	
				Dollars	Cents
SUBTOTAL					
TAX*					
TOTAL AMOUNT					

TEAR ALONG FOLD

We will ship prepaid and invoice you for the charges.

\$1.50 handling fee will be added to shipping charges.

\*Applicable sales tax will be added to your order.

## 4. METHOD OF PAYMENT:

Uline Account. **Bill me net 30 days.**  Check enclosed.  
 Visa  MC  Discover  AmEx  GSA Smartpay  
 Card # \_\_\_\_\_ Exp. Date \_\_\_\_\_  
 Signature \_\_\_\_\_ CVV \_\_\_\_\_  
 Remit to: ULINE, P.O. Box 88741, Chicago, IL 60680-1741

## 5. NEW CUSTOMERS:

**Qualified new buyers:**  
 Your first order ships right away with our **Instant Credit** program.  
 Receive up to \$1,000 in instant credit. No order hassles.  
 Government agencies, schools and hospitals shipped open account.

## RUSH SHIPMENTS/SPECIAL INSTRUCTIONS



Please request FedEx®, UPS Air; Next Day or 2nd Day, preferred truck line, [liftgate service](#) or special instructions. We will promptly take care of your needs.

## SHIPPING POLICY

Your order is shipped from the nearest Uline location.

- UPS is used whenever possible. However, should your order exceed UPS size or weight limits, "Common Carrier" will be selected to speed delivery to you.

## LIFTGATE SERVICE

Specify Liftgate Service if you need your shipment unloaded off the truck. Recommended for residential motor freight and businesses without a dock. Extra charge for this service varies by carrier.

## RETURNS

Complete the form on the back of packing list and return merchandise **within 30 days**. No authorization number necessary.

## TERMS

Occasionally, prices change without notice due to circumstances beyond our control. All sales are subject to the terms and conditions found on [uline.com](http://uline.com)



A	B	B	B
<b>A-Frame</b>	<b>Back Supports/Belts</b> . . . . . 687	<b>Batteries</b> . . . . . 636, 593	<b>Bogus Paper</b> . . . . . 786
Panel Trucks . . . . . 443, 632	<b>Backpack Vacuums</b> . . . . . 344	<b>Battery Shippers/Labels</b> . . . . . 60,	<b>Bollards/Accessories</b> . . . . . 578-579
Signs . . . . . 201	<b>Badge Holders</b> . . . . . 110	272, 274	<b>Bolt Cutters</b> . . . . . 277
<b>Absorbent Pads</b> . . . . . 332-335, 330,	<b>Badge Printers</b> . . . . . 109, 240	<b>Beakers</b> . . . . . 628	<b>Boltless Shelving</b> . . . . . 470-485, 69
371	<b>Bag Sealers</b> . . . . . 150-155, 190, 230	<b>Beard Nets</b> . . . . . 711	<b>Bookcases</b> . . . . . 558, 553, 542
<b>Access Control Cabinets</b> . . . . . 506	<b>Bag Stands</b> . . . . . 166, 204	<b>Bedding</b> . . . . . 368	<b>Boot-Boy® Boot Cleaner</b> . . . . . 330
<b>Acetate Labels</b> . . . . . 237, 270, 219	<b>Bag Tape/Tapers/Ties</b> . . . . . 138-139	<b>Beer Carriers</b> . . . . . 164, 56, 48	<b>Boot/Shoe Covers</b> . . . . . 704-705,
<b>Acetone</b> . . . . . 376	<b>Bags</b>	<b>Belts</b> . . . . . 687, 849	709, 713, 729, 757
<b>Acoustic Foam</b> . . . . . 789	<b>Anti-Static</b> . . . . . 740-747	<b>Benadryl®</b> . . . . . 824	<b>Boot/Shoe Scrapers</b> . . . . . 330
<b>ADA</b>	<b>Bubble</b> . . . . . 768-770, 740, 744	<b>Benches</b> . . . . . 407, 409, 411-413,	<b>Boot Trays</b> . . . . . 326, 328
<b>Parking Lot Stencil</b> . . . . . 728	<b>Bulk</b> . . . . . 145, 142-143, 747	510, 536, 757	<b>Bootie Butler™/Supplies</b> . . . . . 704
<b>Picnic Tables</b> . . . . . 406	<b>Burlap/Cloth</b> . . . . . 144-147, 168,	<b>Bike Racks</b> . . . . . 411	<b>Boots</b> . . . . . 729, 713
<b>Signs</b> . . . . . 654, 731	181, 184, 778	<b>Bills of Lading/Labels</b> . . . . . 270, 258	<b>Bottle Brushes</b> . . . . . 369
<b>Adhesive Bubble Rolls</b> . . . . . 763	<b>Dog Waste</b> . . . . . 412-413	<b>Bin Carts</b> . . . . . 436, 448, 458, 464,	<b>Bottle Carriers</b> . . . . . 55-56, 164, 170
<b>Adhesive Foam Core Board</b> . . . . .	<b>Dunnage</b> . . . . . 316	496, 750	<b>Bottles</b> . . . . . 622-626, 628-629, 370
792-793	<b>Food Service</b> . . . . . 186-193, 197-199,	<b>Bin Organizers</b> . . . . . 492-499, 656,	<b>Bouffants/Hairnets</b> . . . . . 711, 757
<b>Adhesive Foam Rolls</b> . . . . . 786, 779	54, 144, 146, 152, 164-165	436, 458, 460, 464	<b>Bounce® Dryer Sheets</b> . . . . . 379
<b>Adhesive Transfer Tape</b> . . . . . 808-809,	<b>Garment</b> . . . . . 140, 216	<b>Bin Storage Cabinets</b> . . . . . 493-495,	<b>Bowls</b> . . . . . 196, 382, 389
803, 806	<b>Grocery</b> . . . . . 165-170, 198, 54, 146	506, 656, 516	<b>Bows/Ribbon</b> . . . . . 180, 182
<b>Adhesives</b> . . . . . 800-802, 814, 817	<b>Lawn/Leaf</b> . . . . . 417	<b>Binders/Binder Clips</b> . . . . . 634-635	<b>Box Cutters</b> . . . . . 642-645, 51, 88,
<b>Adirondack Chairs</b> . . . . . 412	<b>Newspaper</b> . . . . . 141	<b>Bins</b>	107, 229, 785, 829, 835, 844
<b>Adjustable Height</b>	<b>On a Roll</b> . . . . . 152-153, 141, 768	<b>Anti-Static/Conductive</b> . . . . . 750-751	<b>Box Liners</b> . . . . . 50-51, 54, 31
<b>Desks</b> . . . . . 555-557, 547, 551	<b>Paper</b> . . . . . 160-165, 188-193, 199	<b>Corrugated</b> . . . . . 488-489, 42, 65	<b>Box Trucks</b> . . . . . 432, 440, 430
<b>Workbenches</b> . . . . . 522, 534	<b>Poly</b> . . . . . 112-199, 218-219, 613,	<b>Divider</b> . . . . . 503, 750-751	<b>Boxes</b>
<b>Advil®/Aleve®</b> . . . . . 724	746-747, 797	<b>Food</b> . . . . . 194-195	<b>Bulk Cargo</b> . . . . . 42-48, 422-425, 337
<b>Aerial Work Platforms</b> . . . . . 565	<b>Reclosable</b> . . . . . 112-123, 168,	<b>Outdoor Storage</b> . . . . . 337, 494	<b>Chipboard</b> . . . . . 72, 172-177,
<b>Aerosol Shippers</b> . . . . . 60	187-192, 216, 743-746, 768, 797	<b>Recycling</b> . . . . . 405, 403	179, 184
<b>Aerosols</b> . . . . . 800-801, 798	<b>Retail/Shopping</b> . . . . . 160-171, 181,	<b>Shelf/Stackable</b> . . . . . 488-492,	<b>Corrugated</b> . . . . . 4-37, 43-45, 53,
<b>Air</b>	184, 204, 216-219, 144-147, 778	498-503, 750	55-72, 74-85, 176-177, 388
<b>Conditioners</b> . . . . . 572-573	<b>Sand</b> . . . . . 146	<b>Slatwall</b> . . . . . 211	<b>Divider</b> . . . . . 503, 750-751
<b>Curtains</b> . . . . . 575	<b>Take-Out</b> . . . . . 198-199, 164-168	<b>Sterilite®</b> . . . . . 470, 177, 220,	<b>File Storage</b> . . . . . 70-73, 65, 471, 666
<b>Cushion Machines</b> . . . . . 771, 778	<b>Trash Liners</b> . . . . . 392-399, 403,	266, 516	<b>Food</b> . . . . . 192-195, 72, 179, 388-389
<b>Duster/Air in a Can</b> . . . . . 801	405, 410-413, 613	<b>Tip-Out</b> . . . . . 516	<b>Gaylord</b> . . . . . 42-45, 48
<b>Filters</b> . . . . . 574	<b>VCI</b> . . . . . 797	<b>Totes</b> . . . . . 498-503, 508-509, 516	<b>Gift/Retail</b> . . . . . 172-179, 182-185, 102
<b>Fresheners</b> . . . . . 362, 365, 375	<b>Bakery Bags/Boxes</b> . . . . . 188-193	<b>Wire</b> . . . . . 206, 424, 498	<b>Hazardous Materials</b> . . . . . 58-61
<b>Guns</b> . . . . . 316	<b>Baking Pans/Racks</b> . . . . . 196	<b>Biohazard Bags/Cans</b> . . . . . 395, 404	<b>Insulated</b> . . . . . 50-55
<b>Horn/Bullhorns</b> . . . . . 730	<b>Balaclava</b> . . . . . 714, 716	<b>Blade Disposal Container</b> . . . . . 645	<b>Mailers/Shippers</b> . . . . . 74-85
<b>Hose Reels</b> . . . . . 638	<b>Baling Wire</b> . . . . . 303	<b>Blades</b> . . . . . 642-645, 51, 88, 107,	<b>Moving</b> . . . . . 62-68
<b>Pillow Machines</b> . . . . . 771, 778	<b>Ballot Boxes</b> . . . . . 203	229, 785, 829, 835, 844	<b>Plastic</b> . . . . . 494, 503, 508, 516, 73,
<b>Purifiers</b> . . . . . 575	<b>Ballpoint Pens</b> . . . . . 635	<b>Blankets</b>	177, 220, 470-471, 102
<b>Aisle Signs</b> . . . . . 652-653, 821	<b>Bandages</b> . . . . . 725, 722-723	<b>Drum/Tank Heating</b> . . . . . 612, 608	<b>Take-Out</b> . . . . . 388-389
<b>Alcohol, Isopropyl</b> . . . . . 725	<b>Bandanas, Cooling</b> . . . . . 718	<b>Emergency</b> . . . . . 722-723	<b>Brake Cleaners</b> . . . . . 800
<b>Aluminum Foil Wrap/Pans</b> . . . . . 389	<b>Banding</b> . . . . . 299, 302-303, 305,	<b>Ice</b> . . . . . 55	<b>Breakroom Supplies</b> . . . . . 380-391,
<b>Amber Bottles/Jars</b> . . . . . 626-629	307-311, 392, 228, 109	<b>Insulated</b> . . . . . 49	398-399, 405
<b>Amber UV Bags</b> . . . . . 120	<b>Bankers Box®</b> . . . . . 70	<b>Moving</b> . . . . . 65	<b>Brochure Holders</b> . . . . . 202-203,
<b>American Flags</b> . . . . . 414	<b>Bar and Pipe Racks</b> . . . . . 486-487	<b>Bleach</b> . . . . . 378	205-206, 208, 210, 656, 283
<b>Angle Brooms</b> . . . . . 380, 342	<b>Bar Mop Towels</b> . . . . . 349	<b>Bleachers</b> . . . . . 415	<b>Broom/Mop Holders</b> . . . . . 371, 373-374
<b>Announcement Envelopes</b> . . . . . 108	<b>Barcode Printers/Supplies</b> . . . . .	<b>Block Pallet</b> . . . . . 420	<b>Brooms</b> . . . . . 342-343, 369, 373, 380
<b>Ansell Gloves</b> . . . . . 670, 672-673,	240-251	<b>Bloodborne Pathogen Kits</b> . . . . . 723	<b>Brother® Label Printers</b> . . . . . 240
676-678, 684-685, 756	<b>Barcode Scanners</b> . . . . . 250	<b>Blowers, Portable</b> . . . . . 346	<b>Brushes</b>
<b>Anti-Fatigue Mats</b> . . . . . 318-323,	<b>Barricade Tape</b> . . . . . 818	<b>Boards</b>	<b>Boot/Shoe</b> . . . . . 330
328-329, 331, 755	<b>Barriers</b>	<b>5S</b> . . . . . 373	<b>Bottle</b> . . . . . 369
<b>Anti-Slip</b>	<b>Crowd Control</b> . . . . . 204-205, 208,	<b>Bulletin</b> . . . . . 630, 632, 413, 555	<b>Floor/Counter</b> . . . . . 342-343
<b>Floor Signs</b> . . . . . 819-821, 371	416, 824, 582-583, 734-736	<b>Calendar</b> . . . . . 631	<b>Paint</b> . . . . . 638
<b>Pallet Paper</b> . . . . . 40	<b>Dust</b> . . . . . 148	<b>Chalk</b> . . . . . 201	<b>Scrub</b> . . . . . 369
<b>Tape/Treads</b> . . . . . 819-821, 823	<b>Flood/Spill Control</b> . . . . . 146, 604-608	<b>Clipboard</b> . . . . . 637	<b>Snow/Vehicle</b> . . . . . 372
<b>Anti-Static Supplies</b> . . . . . 740-753,	<b>Guards/Rails</b> . . . . . 576-583	<b>Cork</b> . . . . . 631, 413	<b>Toilet</b> . . . . . 366
755, 781, 84, 260, 288	<b>Magnetic Retractable</b> . . . . . 582	<b>Cutting</b> . . . . . 197	<b>Wire</b> . . . . . 374
<b>Apparel Boxes</b> . . . . . 176-177,	<b>Plastic Fence</b> . . . . . 737	<b>Dock</b> . . . . . 598-599	<b>Brute® Containers/Dollies</b> . . . . . 397,
172-174, 184	<b>Security Gates</b> . . . . . 580-585, 577	<b>Dry Erase</b> . . . . . 630-632, 634, 201	195, 404-405, 508
<b>Aprons</b> . . . . . 710	<b>Traffic</b> . . . . . 730, 732-739, 583	<b>Foam/Poster</b> . . . . . 792-793	<b>Bubble</b>
<b>Artwork Shippers/Boxes</b> . . . . . 68-69,	<b>Basket Trucks</b> . . . . . 433, 352, 430	<b>Gridwall</b> . . . . . 209	<b>Bags</b> . . . . . 768-770, 740, 744
74-76, 773	<b>Baskets, Shopping</b> . . . . . 220	<b>Message</b> . . . . . 199-201, 413	<b>Cushioning</b> . . . . . 763-772, 740-744,
<b>Asphalt Repair Compound</b> . . . . . 728	<b>Bath Towels</b> . . . . . 368	<b>Pegboard</b> . . . . . 632-633	50-51
<b>Assembly Tables</b> . . . . . 518-535, 753	<b>Bathroom Signs</b> . . . . . 654, 371	<b>Shadow</b> . . . . . 373	<b>Dispensers/Stands</b> . . . . . 770
<b>Asset Labels</b> . . . . . 260	<b>Bathroom Supplies</b> . . . . . 355-368,	<b>Slatwall</b> . . . . . 211-212, 638	<b>Machines</b> . . . . . 771, 778
<b>AV/Computer Carts</b> . . . . . 438-439, 556	375, 416	<b>White</b> . . . . . 630-632, 634, 201	<b>Mailers</b> . . . . . 93-94, 96, 103-104, 51

## B

Buckets/Pails . . . 616-618, 340-341, 614, 380, 194  
 Buckets/Wringers . . . 371, 331, 340  
 Buckles, Strapping . . . . 308-309  
 Bug Spray . . . . . 374  
 Bulbs, Light . . . . . 658-659  
 Bulk Bags . . . . . 145, 142-143, 747  
 Bulk Cargo Boxes . . . . . 42-48  
 Bulk Containers . . . . . 422-425, 337, 494  
 Bulk Storage Lockers . . . . . 510, 581  
 Bulk Trucks . . . . . 430-433  
 Bulletin Boards . . . . . 630-632, 413, 555  
 Bullhorns/Air Horn . . . . . 730  
 Bumper Guards . . . . . 579-581, 599  
 Bundle Wrap . . . . . 292-293  
 Bung Wrench . . . . . 614  
 Bungee Cords . . . . . 594  
 Burlap Bags/Rolls . . . . . 147  
 Butcher Paper . . . . . 785

## C

Cabinet Workbenches . . . . . 520, 525-526, 531-532

**Cabinets**

Access Control . . . . . 506  
 Bin Storage . . . . . 493-495, 506, 656, 516  
 Breakroom . . . . . 386  
 Charging . . . . . 438, 505  
 File . . . . . 558-559, 542-553  
 Fire Extinguisher . . . . . 602  
 Flammable/Corrosive . . . . . 600-605  
 Gas Cylinder . . . . . 603  
 Key . . . . . 517, 509  
 Mobile . . . . . 494-495, 509  
 Parts . . . . . 516, 493-495, 506, 656  
 Storage/Supply . . . . . 504-509, 632, 348, 493-495, 656  
 Tool . . . . . 494, 632, 639  
 Wardrobe . . . . . 507, 348

Cable/Cord Protectors . . . . . 738-739, 569, 826

Cable Cutters . . . . . 277-278

Cable Locks . . . . . 514, 276, 278

Cable Seals . . . . . 276, 278

Cable Tie Mounts . . . . . 159

Cable Ties/Guns . . . . . 156-159

Cable Ties, Velcro® . . . . . 815

Café/Cafeteria Tables . . . . . 543, 546, 560, 410, 412, 539

Cake/Candy Boxes . . . . . 192-193

Calculator . . . . . 635

Calendars . . . . . 631, 635

Calibration Weights . . . . . 662

Can Carriers . . . . . 56, 48

Candle Tins . . . . . 182

Canning Jars/Boxes . . . . . 625, 72

Canopies . . . . . 414-416, 406

Cans . . . . . 618, 59

Cantilever Racks . . . . . 487

Caps

Headwear . . . . . 718, 711  
 Tubes . . . . . 90, 97

Car Shelter . . . . . 414

Carboy Jugs/Racks . . . . . 619

## C

Cardboard Sheets . . . . . 38-42, 192

**Cargo Containers**

Bags . . . . . 145, 142-143, 747  
 Boxes, Rubbermaid® . . . . . 494  
 Bulk . . . . . 42-48, 422-425, 337

**Cargo/Load Bars** . . . . . 594

**Cargo Net** . . . . . 591

**Carpet/Floor Protection** . . . . . 810-811, 788, 148, 704-705

**Carpet Mats** . . . . . 324-327, 329-330, 819, 317

**Carpet Tape** . . . . . 810-811

**Carrying Cases** . . . . . 80, 164, 170, 66, 49, 55-56

**Carton Sealing Tape** . . . . . 850-851, 841-849, 828-834

**Carton Sizer** . . . . . 31

**Carton Stands** . . . . . 31

**Carton Staples/Staplers** . . . . . 666-669

**Carts**

Basket . . . . . 432-433, 462, 464, 352, 97, 216, 220  
 Bin . . . . . 436, 448, 458, 464, 496, 750  
 Computer/AV . . . . . 438-439, 556  
 Divider Box . . . . . 458, 750  
 Drawer . . . . . 220, 435-436, 458, 97, 750  
 Drywall . . . . . 442-443  
 ESD . . . . . 748, 750  
 Flat Shelf . . . . . 434-437, 441, 468  
 Folding . . . . . 444, 263, 447-448, 241, 374, 352  
 Handi-Movers . . . . . 444, 241  
 Janitor . . . . . 370, 368, 352, 430-433  
 Luggage . . . . . 200  
 Mail . . . . . 462  
 Organizer . . . . . 97  
 Panel . . . . . 442-443  
 Pegboard . . . . . 632  
 Picking . . . . . 440, 448, 458, 374  
 Platform . . . . . 442-445, 440, 450-451, 241, 431, 468  
 Receiving . . . . . 437  
 Retail . . . . . 208, 216, 220, 263  
 Security . . . . . 458, 465, 584, 438-440  
 Service . . . . . 467-468, 448, 434-441, 526, 368  
 Shopping . . . . . 220  
 Stainless Steel . . . . . 441, 444, 465, 467-468  
 Strapping . . . . . 298-301, 304-306  
 Tool . . . . . 639, 584, 632, 436, 593  
 Traffic Cone . . . . . 735  
 Utility . . . . . 434-448, 457-468, 584, 208, 241, 368  
 Wire . . . . . 457-468, 438, 748, 31, 97, 220, 464

**Cases, Equipment** . . . . . 49

**Cash Register Paper** . . . . . 198, 241

**Casters** . . . . . 446, 457, 518, 423

**Ceiling Fan** . . . . . 570

**Cello/Polypropylene Rolls** . . . . . 185

**Cellophane Bags** . . . . . 190

**Cellulose Wadding** . . . . . 790-791

**Chains** . . . . . 204, 578, 588-589, 824

**Chair Mats** . . . . . 317

## C

**Chair/Table Dollies** . . . . . 538-539

**Chairs/Stools** . . . . . 518-560, 410, 412, 414, 470, 753

**Chalkboard** . . . . . 201

**Channelizer Cones** . . . . . 733

**Charging Cabinets** . . . . . 438, 505

**Chart Tape** . . . . . 837

**Chicken Wire** . . . . . 728

**Chipboard Boxes** . . . . . 72, 172-177, 179, 184

**Chipboard Pads** . . . . . 41

**Chocks** . . . . . 589

**Chrome Shelving** . . . . . 452-453, 456-464

**Cigarette Receptacles** . . . . . 402-403

**Circuit Breaker Lockouts** . . . . . 726

**Clean Mats** . . . . . 755

**Cleaners and Chemicals** . . . . . 374-379, 800-801

**Cleaning Supplies** . . . . . 331-381, 392-405, 754-755, 800-801

**Cleanroom Supplies** . . . . . 752-757, 352, 628

**Clearance Bar** . . . . . 739

**Clipboards** . . . . . 637

**Clocks** . . . . . 637

**Clorox®** . . . . . 375, 378, 381

**Clothing**

Cleanroom . . . . . 756-757  
 Cooling . . . . . 718  
 Disposable . . . . . 704-713, 756-757  
 Flame Retardant/Resistant . . . . . 706, 716, 710  
 Insulated . . . . . 714, 716  
 Reflective . . . . . 712-718

**Clothing/Coat Racks** . . . . . 208-215, 206-207

**Clothing Hangers** . . . . . 217

**Coat Hooks** . . . . . 206-207

**Cocktail Table** . . . . . 539

**Coffee Bags** . . . . . 188, 193

**Coffee/Tea Supplies** . . . . . 384-386

**Coin Envelopes** . . . . . 106

**Cold Packs** . . . . . 52-55, 722

**Collapsible Carts** . . . . . 444, 447, 241, 263, 352, 374

**Column Protectors** . . . . . 579

**Combination Locks** . . . . . 514-515

**Command™ Adhesive Strips** . . . . . 804

**Compliance Centers, SDS** . . . . . 726

**Compressed Air Hose** . . . . . 638

**Computer Carts** . . . . . 438-439, 556

**Computer Monitor Mounts** . . . . . 548, 523

**Concrete Cleaner** . . . . . 376

**Concrete Repair Compound** . . . . . 728

**Condiment Organizers** . . . . . 386

**Cones**

Inventory Control . . . . . 311-312  
 Pallet . . . . . 314, 311-312  
 Traffic . . . . . 732-735

**Conference Tables** . . . . . 543-552

**Containers**

Bottles . . . . . 622-626, 628-629, 370  
 Bulk . . . . . 42-48, 422-425, 337, 494  
 Collapsible . . . . . 424-425, 471, 499

## C

**Containers (cont.)**

Food . . . . . 388-389, 194-197, 619-627, 178-179  
 Stack and Nest . . . . . 500, 502, 498  
 Storage . . . . . 177, 220, 266, 337, 470-471, 516  
 Take-Out . . . . . 388-389

**Contractor's Trash Bags** . . . . . 394

**Conveyors** . . . . . 595-597

**Convuluted Foam** . . . . . 773, 749, 789

**Cookie Tins** . . . . . 178

**Cool Shield Bubble** . . . . . 50-51

**Coolers** . . . . . 391, 383, 573, 53-55

**Cooling Apparel** . . . . . 718

**Cord Protectors** . . . . . 569, 738-739, 826

**Cord Reels** . . . . . 568-569

**Cord Strapping** . . . . . 308

**Cork Boards** . . . . . 631, 413

**Corner Guard Rails** . . . . . 576

**Corner Protectors** . . . . . 312-315, 763, 770, 776, 824, 581

**Corner Wall Guard** . . . . . 824

**Corrosive Storage Cabinets** . . . . . 600

**Corrugated**

Bins . . . . . 488-489, 42, 65  
 Boxes . . . . . 4-37, 43-45, 53, 55-72, 74-85, 176-177, 388  
 Cohesive Wrap . . . . . 791  
 Fanfold Sheets . . . . . 40  
 Mailers/Shippers . . . . . 74-85, 53, 55-68, 173, 748-749, 773, 778  
 Pads . . . . . 38-42, 192  
 Plastic . . . . . 38  
 Protectors . . . . . 312  
 Receptacles . . . . . 403  
 Totes . . . . . 65  
 Trays . . . . . 48, 38  
 Tubes . . . . . 90  
 Wrap . . . . . 791

**Cotton Balls** . . . . . 725

**Cotton Gloves** . . . . . 681

**Cotton Inserts** . . . . . 174

**Cotton Pouches** . . . . . 168, 144

**Cotton Tipped Applicators** . . . . . 724

**Counter Displays** . . . . . 202-203

**Coveralls** . . . . . 706-709, 714, 716, 757

**Covers**

Bollard . . . . . 578-579  
 Drain . . . . . 604  
 Pallet . . . . . 142-143, 49, 51, 232, 747  
 Protective . . . . . 64-65, 148, 140  
 Rack . . . . . 196, 215  
 Shelving . . . . . 460, 456  
 Shoe/Toe . . . . . 704-713, 729, 757  
 Table . . . . . 390, 539  
 Tarps . . . . . 145, 818  
 Toilet Seat . . . . . 362

**Cranes** . . . . . 588

**Crates**

Plastic Milk Style . . . . . 471, 499  
 Wood . . . . . 46-47

**Creamer, Coffee** . . . . . 386

**Credenzas** . . . . . 542, 547, 550

**Crinkle Paper** . . . . . 185

**Crosswalk Sign** . . . . . 733

**Crowd Control** . . . . . 204-205, 208, 416, 824, 582-583, 734-736

C	
Cube Trucks	432
Cubicles	547
Cup Dispensers	386, 382
Cupcake Containers	192
Cups	382-385, 195
Curbs	738-739, 580
Curtain Walls	587, 584
<b>Cushioning</b>	
Anti-Static	740-742, 744, 748-749
Bubble	763-772, 50-51, 778
Cellulose Wadding	790-791
Corrugated Wrap	791
Foam	772-779, 770, 786, 763, 742, 748-749
Insulated	49-55, 31
Pads	781
Paper	782-791, 780
Peanuts	781
Tissue/Crinkle Paper	182-183, 185, 787
Vermiculite	780
Cushioning Systems	771, 778-779
<b>Cutters</b>	
Bolt	277
Box	642-645, 51, 88, 107, 229, 785, 829, 835, 844
Cable/Wire	277-278
Edge Protector	312
Foam	776
Paper	782, 785, 789, 180
Safety	644, 107, 180, 286, 642
Cutting Boards	197
Cylinder Cabinets	603

D	
Damage Indicators	798-799
Decking, Pallet Racks	478, 481-482
Degreasers	376-377, 800-801
Dehumidifiers	575
Deli Containers	388-389, 195
Delineator Posts	732-733
Depository Safes	517
Desiccants	794-795
Desks	542-561, 531, 524-526
Desktop Accessories	97, 637
Desktop Risers	556
Detergent	378-379
DeWalt® Vacuums	344, 348
Digital Safes	517
Direct Thermal Labels	247-251, 241
Dish Pack Boxes	64
Dish Soap	378-379
<b>Disinfectants</b>	
Cleaners	375-379, 381, 353
Hand Sanitizer	365-367, 381
Isopropyl Alcohol	725
Soap	362-366, 356
Wipes	365-367, 375, 377, 381, 348, 353
<b>Dispensers</b>	
Bubble/Foam	770
Food Service	194-197, 386-391, 382
Hand Sanitizer	367
Label	271, 237
Paper Cushioning	780-791

D	
<b>Dispensers (cont.)</b>	
Paper Towel	355-359, 353
Peanut	780
Safety Wear	690-697, 704-705, 674-675
Shrink Film	232
Soap	362-366, 356
Stretch Wrap	286, 293-295
Tape	808-811, 823-848, 271
Toilet Tissue	361-362, 366
Utensil	387
<b>Display</b>	
Boxes	174-185, 192, 202-203
Racks	206-217, 202, 656
Strips	221
Tables/Shelves	206-208, 211-214
Trays	185, 196
<b>"Do Not Stack"</b>	
Cones	314
Labels	252-255, 258-259, 261
<b>Dock Boards/Plates</b>	598-599
<b>Dock Bumpers</b>	599
<b>Dock Door Signs</b>	652
<b>Dock Equipment</b>	586-599, 576-585, 652
<b>Dock Lights</b>	582, 656
<b>Dog Waste Bags/Systems</b>	412-413
<b>Dollies</b>	
Bar/Pipe	486-487
Bulk Container	425
Cabinet	505, 559, 601
Chair/Table	538-539
Drum/Pail	606, 610, 613
Hand Trucks	447-451, 656, 442, 610
Hardwood	447
Heavy Duty Steel	447
Plastic	447, 396-397, 404, 501
Tote	501
Trash Can	396-397, 404
<b>Door Kick Plates</b>	331
<b>Door Track Protectors</b>	583
<b>Doorknob Bags</b>	141
<b>Doorstops</b>	221
<b>D.O.T. Labels/Placards</b>	272-275
<b>Double Wall Boxes</b>	31-33, 43-44, 56-71
<b>Double Wall Dome Jars</b>	620
<b>Drain Seals</b>	604
<b>Drainage Mats</b>	322-323, 328
<b>Drawer Cabinets</b>	494, 516
<b>Drawer Carts</b>	220, 435-436, 458, 97, 750
<b>Drawer Organizers</b>	637, 639
<b>Drawing Bags</b>	
Burlap	147
Cloth Parts/Mailing	144, 147
Gift/Favor	147, 168, 181, 184
Ice Cube	144
Mesh Produce	146
Poly	119
Shopping	169
Trash Liners	394, 398-399, 405
<b>Dri-Shield® Bags</b>	744
<b>Drop Boxes</b>	509
<b>Drop Cloths</b>	148
<b>Drop-N-Tell® Indicators</b>	799

D	
<b>Dropper Bottles</b>	629
<b>Droppers</b>	628
<b>Drum Equipment</b>	
Covers	613
Cradles	610
Faucets	611, 614-615
Flammable Storage	601
Funnels	615
Grabbers	612
Heaters	612
Label, Overpack	272
Liners	613
Opener	614
Overpacks	607, 605
Pallets/Workstations	607-608, 418-420
Pumps	614-615, 608
Shed	606
Spill Containment	604-608
Trucks/Dollies	610, 613, 606
Vacuum Top	345
<b>Drum Fans</b>	570-571, 573
<b>Drums</b>	609-612, 658, 734
<b>Dry Erase Boards/Accessories</b>	630-632, 634, 201
<b>Dryer Sheets</b>	379
<b>Drywall Carts</b>	442-443
<b>Dual Lock™</b>	814
<b>Duct Tape</b>	827, 814
<b>Dump Bins</b>	206, 352, 216, 424
<b>Dumping Hoppers</b>	423, 431
<b>Dunnage Bags</b>	316
<b>Dunnage Racks</b>	466, 470
<b>Dust Cloths</b>	369, 348-349
<b>Dust Masks</b>	696-701
<b>Dust Mops</b>	338, 340, 372, 375, 754
<b>Dust Pans</b>	342-343, 369, 380
<b>Dusters</b>	348, 372, 375, 754, 801
<b>Dymo® Label Printers</b>	251, 241
<b>Dyneema® Gloves</b>	685

E	
<b>E-Track</b>	
Beams	594
Rails	591
Tie-Downs	590-592
<b>E-Z Floor Guards™</b>	704
<b>Earmuffs</b>	694
<b>Earplugs</b>	694-695
<b>Easels/Easel Backs</b>	634, 203
<b>Easy-Fold Mailers</b>	74-76
<b>Econo-Wrapper®</b>	291
<b>Edge Protector Cutter</b>	312
<b>Edge Protectors</b>	312-315, 763, 770, 776, 824, 581
<b>Egg Filler Flats</b>	503
<b>Elastic Bands/Cords</b>	109-110, 180, 280, 297, 392, 594
<b>Electric Pallet Trucks</b>	428, 426
<b>Electrical Lockouts</b>	726-727
<b>Electrical Tape</b>	826
<b>Emergency Lights</b>	657, 730, 732
<b>Emergency Blankets</b>	722-723
<b>Envelopes</b>	92-108, 89, 646-649, 757-762, 840
<b>Epoxy Wire Shelving</b>	465-466
<b>ESD Supplies</b>	740-755

E	
<b>Evaporative Coolers</b>	573
<b>Event Tents</b>	414-416
<b>Excelsior Cushioning</b>	185
<b>Exit Signs</b>	655, 657, 821, 205
<b>Extension Cords</b>	568-569
<b>Extension Ladders</b>	566-567
<b>Eye Protection</b>	688-693, 700
<b>Eyewash Stations</b>	719-721

F	
<b>F-Style Jugs/Shippers</b>	619, 59-60
<b>Face Masks</b>	697, 700, 718
<b>Face Shields</b>	692, 699-701, 711, 716, 718
<b>Facial Tissue</b>	357
<b>Fall Protection</b>	702-703
<b>Fanfold Corrugated</b>	40
<b>Fans</b>	570-575, 416, 582, 346, 523, 535, 568, 34
<b>Faucets, Drum</b>	611, 614-615
<b>Fencing</b>	730, 734-737, 728, 576-585
<b>FIBC</b>	145
<b>Filament Tape</b>	838-839
<b>File Boxes</b>	70-73, 65, 471, 666
<b>File Cabinets</b>	558-559, 542-553
<b>File Folders</b>	108, 96
<b>Filters, HVAC</b>	574
<b>Finger Cots</b>	675
<b>Finger Tape</b>	722
<b>Fire Extinguishers</b>	
Accessories	602
Emergency Road Kit	730
Signs	602, 654-655, 657, 652
<b>Fire-Resistant File Cabinets</b>	559
<b>Fire Retardant Poly Sheeting</b>	148
<b>First Aid</b>	722-725, 719-721
<b>Flagging Tape</b>	818
<b>Flags</b>	414, 737
<b>Flame Retardant/Resistant Clothing</b>	706, 716, 710
<b>Flammable Storage</b>	600-605
<b>Flares</b>	730, 732
<b>Flashlights</b>	638, 729
<b>Flatware, Stainless Steel</b>	387
<b>Fleet Safety Kit</b>	730
<b>Flood Barriers</b>	146, 604-605
<b>Floor/Carpet Protection</b>	788, 811, 148, 704-705
<b>Floor Cleaners</b>	347, 340, 375-379, 336
<b>Floor Crane</b>	588
<b>Floor Fans</b>	570-573, 568, 346
<b>Floor Mats</b>	317-331, 755, 819
<b>Floor Paint</b>	819
<b>Floor Scales</b>	662-663
<b>Floor Scrapers</b>	338
<b>Floor Scrubbers</b>	347
<b>Floor Signs</b>	819-823, 371
<b>Floor Sweep</b>	336, 342-348, 369, 373, 375, 380
<b>Floor Tiles</b>	329, 322, 328
<b>Floor/Window Squeegees</b>	347, 340-341, 372
<b>Fluorinated F-Style Jugs</b>	619
<b>Fly Trap Bag</b>	374
<b>Foam Bumper Guards</b>	581



**F**

Foam Coolers . . . . . 53-55  
 Foam Core Board . . . . . 792-793  
 Foam Cups . . . . . 385  
**Foam Cushioning**  
 Anti-Static . . . . . 742, 748-749  
 Corner Guards . . . . . 312, 770, 776  
 Cutters . . . . . 776, 785  
 Dispensers . . . . . 770  
 Instapack Quick® . . . . . 779  
 Pick and Pack . . . . . 772, 778  
 Tubing . . . . . 763  
 Foam Floor Tiles . . . . . 329  
 Foam Shippers . . . . . 53-59, 68, 84,  
 748-749, 773, 778  
 Foil Pans . . . . . 389  
 Foil Tape . . . . . 816  
 Folders . . . . . 96, 108  
 Folding Carts . . . . . 444, 263,  
 447-448, 241, 374, 352  
 Folding Chairs/Tables . . . . . 536-539,  
 534, 557, 546, 560, 263, 526  
 Folding Hand Trucks . . . . . 447-451  
**Food Service**  
 Equipment . . . . . 194-197, 192, 146  
 Gloves . . . . . 675  
 Retail Packaging . . . . . 185-199,  
 144, 178-179, 72  
 Serveware/Utensils . . . . . 382-388  
 Storage . . . . . 194-197, 619-627  
 Take-Out Bags/Boxes . . . . . 198-199,  
 160-168, 388-389  
 Transport . . . . . 52-56, 50, 388-389  
 Vacuum Bags . . . . . 152, 197  
 Worktables . . . . . 532-535  
 FoodSaver® . . . . . 197, 152  
 Forced Air Heaters . . . . . 575  
 Forklift  
 Aerial Platforms . . . . . 565  
 Fork Extension Rack . . . . . 486  
 Fork Extensions . . . . . 598  
 Safety Light . . . . . 582  
 "Fragile" Labels . . . . . 252-254,  
 258-259, 261  
 Frame Protectors . . . . . 312, 763,  
 770, 776  
 Frames . . . . . 198-202  
**Free Offers** . . . . . 862-867  
 Freeze Indicator . . . . . 798  
 Freezer  
 Bags . . . . . 118  
 Clothing . . . . . 716, 714, 676-683  
 Paper . . . . . 785  
 Tape . . . . . 823  
 Fromm Strapping Tools . . . . . 308  
 Frosty Shoppers . . . . . 170-171, 166  
 Funnels . . . . . 615, 604  
 Furniture  
 Office . . . . . 536-561, 630-634  
 Outdoor . . . . . 406-417, 403  
 Furniture Covers . . . . . 140, 64-65, 148  
 Furniture Dollies . . . . . 447, 505,  
 538-539, 559

**G**

Gable Boxes . . . . . 179, 170  
 Gaffer's Tape . . . . . 826  
 Galvanizing Spray . . . . . 728

**G**

Gantry Cranes . . . . . 588  
 Garage Floor Mats . . . . . 330-331  
 Garbage Bags . . . . . 392-399, 403,  
 405, 410-413, 417, 613  
 Garbage Cans . . . . . 395-416, 372,  
 386, 366  
 Garment Bags . . . . . 140, 216  
 Garment Racks . . . . . 208-215,  
 206-207  
 Garment Steamers . . . . . 216  
 Garment Tags . . . . . 221-225, 219  
 Gas Cans . . . . . 604  
 Gas Cylinder  
 Cabinets/Racks . . . . . 603-604  
 Hand Trucks . . . . . 449  
 Gates . . . . . 584-585, 577-583  
 Gatorade® . . . . . 391  
 Gatorfoam® Board . . . . . 792  
 Gaylord Boxes . . . . . 42-45, 48  
 Gear Lockers . . . . . 510  
 Gel Pens . . . . . 635  
 GHS Labels . . . . . 274, 273  
 Gift Bags . . . . . 160-171, 181, 184  
 Gift Boxes . . . . . 172-179, 182-185, 102  
 Gift Wrap/Supplies . . . . . 180-185,  
 787, 792  
 Glad® Trash Bags . . . . . 398  
 Glass Bottles/Jars . . . . . 625-629  
 Glass Cleaners . . . . . 376-379, 341  
 Glass Dry Erase Boards . . . . . 630, 634  
 Glasses, Safety . . . . . 688-693, 700  
 Glassine Bags . . . . . 193  
 Glassine Envelopes . . . . . 102  
 Glassine Paper . . . . . 792  
 Glove Dispensers . . . . . 674-675  
**Gloves**  
 Butcher . . . . . 675  
 Cleanroom . . . . . 756, 752  
 Cut Resistant . . . . . 684-687, 752  
 Disposable . . . . . 670-676, 756  
 ESD . . . . . 752  
 Food Service . . . . . 675  
 High Grip . . . . . 676-683  
 Inspection . . . . . 681, 677, 752, 756  
 Lifting . . . . . 702  
 Puncture Resistant . . . . . 676, 684  
 Glue . . . . . 814, 817, 800-802  
 Glue Dots® . . . . . 802  
 Glue Guns/Sticks . . . . . 817  
 Goggles . . . . . 691, 693, 688  
 Gojo® Hand Towels . . . . . 354  
 Gojo® Soap/Dispensers . . . . . 363-365  
 Gondola Shelving . . . . . 206-207, 211  
 Goo Gone® . . . . . 376  
 Goodwrappers® . . . . . 290, 292, 288  
 Goof Off® . . . . . 801  
 Gorilla Adhesives/Tape . . . . . 814  
 Gowning Benches . . . . . 757  
 Gowns, Protective . . . . . 707-708, 757  
 Gravity Conveyors . . . . . 595-597  
 Gravity Shelving . . . . . 460, 496  
 Grease Spray . . . . . 798, 800-801  
 Green Sweep . . . . . 336  
 Gridwall Panels/Accessories . . . . .  
 208-209  
 Grocery Bags . . . . . 165-170, 198,  
 54, 146

**G**

Grosgrain Ribbon . . . . . 180  
 Grounders . . . . . 752-753, 755  
 Guard Rails . . . . . 576-580, 582-583  
 Guitar Boxes . . . . . 66  
 Gun Case . . . . . 49  
 Gusseted Bags . . . . . 136-143,  
 160-171, 184-193, 747, 797, 119  
 Gym Mats . . . . . 329  
 Gym Wipes . . . . . 353

**H**

Hairnets/Bouffants . . . . . 711, 754  
 Hammer . . . . . 592  
 Hammer Tackers . . . . . 666  
 Hand Dryers . . . . . 357  
 Hand Sanitizer . . . . . 365, 367, 381  
 Hand Sealers . . . . . 150, 152-155,  
 190, 230, 232, 197  
 Hand Soap . . . . . 362-366, 356  
 Hand Tools . . . . . 592, 639, 277-278  
 Hand Towels . . . . . 368, 354-359,  
 380-381  
 Hand Trucks . . . . . 447-451, 656,  
 442, 610  
 Hand Wash Station . . . . . 416  
 Hand Wipes . . . . . 354, 365, 367, 390  
 Handwrappers . . . . . 286, 290,  
 292-293  
 Hang Hole Bags . . . . . 121-123, 187,  
 190-191, 141  
 Hang Hole Envelopes . . . . . 646-648  
 Hang Tabs . . . . . 221  
 Hanger Racks . . . . . 217, 208, 213-215  
 Hangers . . . . . 217, 206-207  
 Hard Hats . . . . . 729  
 Hardboard Sheets . . . . . 788  
 Hardware Bags . . . . . 164  
 Harnesses . . . . . 702-703  
 Hat Boxes . . . . . 173  
 Hats . . . . . 718, 729, 714  
 Hazmat Labels/Placards . . . . . 272-275  
 Hazmat Packaging . . . . . 58-61  
 Headgear . . . . . 718, 729, 692,  
 709, 711, 714, 754  
 Headlamp . . . . . 729  
 Hearing Protection . . . . . 694-695  
 Heat Guns . . . . . 230, 232  
 Heat/Humidity Indicators . . . . . 798  
 Heat Sealers . . . . . 150-155, 190,  
 230, 232, 197  
 Heaters . . . . . 574-575, 608, 612,  
 410, 568  
 Helmets . . . . . 729  
 Hi-Vis Apparel . . . . . 712-718, 679  
 Hi-Vis Canopies/Trash Cans . . . . . 416  
 High Access Cleaning Tools . . . . .  
 372, 340-341  
 Highway Warning Kits . . . . . 730, 732  
 Hole Punch . . . . . 666  
 Honey Bottles . . . . . 624  
 Honeycomb Pads/Runners . . . . . 42  
 Hook and Loop Tape . . . . . 812-815  
 Hooks . . . . . 206-210, 632-633,  
 653, 222  
 Hoppers . . . . . 423, 431, 502  
 Horns . . . . . 730  
 Hose/Reels, Air . . . . . 638

**H**

Hot Knife . . . . . 776  
 Huck Towels . . . . . 349  
 Hull Tape . . . . . 233  
 HyFlex® Gloves . . . . . 677-678, 684-685

**I**

IBC Tanks/Accessories . . . . . 608-609  
 Ice Blankets . . . . . 55  
 Ice Chests . . . . . 383, 391  
 Ice Cube Bags . . . . . 144  
 Ice Melt/Spreaders . . . . . 336-337  
 Ice Packs . . . . . 52-55, 722  
 Ice Totes . . . . . 194  
 ID Cards/Printers . . . . . 109, 240  
 Indented Kraft Paper . . . . . 789  
 Indestructo Mailers . . . . . 82-85  
 Indicators . . . . . 798-799  
 Inflator Guns . . . . . 316  
 Ingredient Bins . . . . . 195  
 Insect Killer/Repellent . . . . . 374  
 Insert Cards . . . . . 649, 206, 491  
 Inspection  
 Gloves . . . . . 681, 677, 752, 756  
 Labels . . . . . 264-267  
 Lights/Magnifiers . . . . . 753  
 Tags . . . . . 283, 285, 602, 719  
 Instapack Quick® Foam . . . . . 779  
 Insulated  
 Box Liners . . . . . 50-51, 54, 31  
 Clothing . . . . . 714, 716  
 Shippers/Supplies . . . . . 49-55, 31  
 Integrated Labels . . . . . 238  
 Inventory Control Cones . . . . . 311-312  
 Inventory Labels . . . . . 262-267, 270  
 Inventory Tags . . . . . 284-285  
 Isopropyl Alcohol . . . . . 725

**J**

Jackets . . . . . 706-709, 712-716, 752  
 Jacks  
 Pallet . . . . . 424, 426-429, 663  
 Trailer . . . . . 598  
 Vehicle . . . . . 592  
 Janitor Carts . . . . . 370, 368, 352,  
 430-433  
**Janitorial Supplies** . . . . . 317-417,  
 754-755  
 Jars . . . . . 620-627  
 Jerricans . . . . . 616, 59  
 Jewelry Boxes . . . . . 174-175, 179  
 Jiffy Mailers . . . . . 100  
 Job Jackets . . . . . 647  
**Job Ticket Holders/Racks** . . . . .  
 646-648, 656, 279  
 Jug/Pail Shippers . . . . . 59-61  
 Jugs/Pails . . . . . 616-619, 614, 626, 380  
 Juice Bottles . . . . . 622, 625

**K**

Kaizen Foam . . . . . 639  
 Kapton® Tape . . . . . 816  
 Keurig® Compatible Coffee  
 Cups . . . . . 384  
 Kevlar® Gloves . . . . . 686  
 Key Cabinets . . . . . 517, 509  
 Key Lock Boxes . . . . . 514  
 Kick Plates . . . . . 331

## K

- Kimberly-Clark®
  - Bathroom Supplies . . . 355-362
  - Gloves . . . . . 672
  - Wipers . . . . . 350-352
- King Pin Locks . . . . . 272
- Kleenex® Tissue/Towels . . 357-359, 355
- Kleiver Safety Cutters . . . 642, 180
- Knaack Jobsite Box . . . . . 818
- Knives
  - Ceramic Blade . . . . . 88, 107
  - Foam Hot Knife . . . . . 776
  - Folding . . . . . 88, 643, 844
  - Food Service . . . . . 387
  - Snap-Blade . . . . . 642, 229
  - Utility . . . . . 642-645, 51, 88, 107, 229, 785, 829, 835, 844
  - X-Acto® . . . . . 644
- Korrvu® Shipper . . . . . 63
- Kraft
  - Bags . . 160-165, 188-193, 199, 417
  - Labels . . . . . 263
  - Paper . . . . . 780-791, 796
  - Take-Out Boxes . . . . . 388
  - Tape/Dispensers . . . . . 830-833
  - Tubes . . . . . 86-90

## L

- Lab Coats . . . . . 706-709, 752, 757
- Lab Workbenches . . . . . 528
- Label
  - Dispensers . . . . . 271, 237
  - Guns . . . . . 223-225
  - Holders . . 238, 649-653, 456, 491
  - Makers/Printers . . 240-241, 246, 248, 250-251, 223-225
  - Protection Tape . . . . . 840, 822
  - Remover . . . . . 800-801, 376
- Labels
  - Anti-Static . . . . . 260
  - Asset . . . . . 260
  - Barcode . . . . . 240-251
  - Bill of Lading . . . . . 270, 258
  - Blockout . . . . . 238, 244, 263
  - Brother® . . . . . 240
  - Choking Hazard . . . . . 273
  - Cleanroom . . . . . 756
  - Clear . . 236-237, 239, 270, 219
  - Consecutive Numbers . . . 265
  - Core . . . . . 257
  - Custom Printed . . . 267-270, 260
  - Direct Thermal . . . 247-251, 241
  - "Do Not..." . . . 252-255, 258-261
  - D.O.T./Regulated . . . . 272-275
  - Dymo® Compatible . . . . 251
  - Fanfold . . . . . 245, 247
  - "Fragile" . . 252-254, 258-259, 261
  - Hazardous Waste . . . . 272-275
  - Inspection . . . . . 264-267
  - Integrated . . . . . 238
  - International Handling . . . 252
  - Inventory . . . . . 262-267, 270
  - Laser . . . . . 234-239
  - "Made In USA" . . . . . 266
  - Magnetic . . . . . 650-651, 653
  - Mailing . . . . . 237-239, 263
  - Monarch® . . . . . 223-225

## L

- Labels (cont.)
  - Number/Letter . . . . . 264-265, 652-653
  - Pallet Protection . . 255-259, 261
  - Production . . . . . 267
  - Prop 65 . . . . . 273
  - Quality Control . . . . . 262, 267
  - Receiving . . . . . 252-261, 266
  - "Refrigerate" . . . . . 254, 258, 252
  - Removable . . . . . 236, 245-251, 262, 652, 223-225
  - Retail . . . . . 218-219, 223-225, 236-239, 241, 266
  - Security/Warning . . 260, 283, 844
  - Shipping . . . . . 252-275, 238
  - Size (XS-XXXL) . . . . . 218-219
  - Special Handling . . . . 252-261
  - Suffocation Warning . . . . 273
  - Tamper Resistant . . . . 260, 844
  - Thermal Transfer . . . . . 243-246
  - Trash . . . . . 266
  - Warehouse . . . 649-653, 262-267
  - "Warranty" . . . . . 266
  - Weatherproof . . 239, 244, 251, 270
- Labware . . . . . 628-629
- Ladders . . . . . 562-567
- Laminators/Supplies . . . . . 111
- Lanyards . . . . . 110, 702-703
- Laptop Carts . . . . . 438-439, 556
- Laptop Mailers . . 84, 63, 748-749
- Laser Labels . . . . . 234-239
- Latex Gloves . . . . . 670-686, 756
- Laundry Carts . . 432-433, 352, 216
- Laundry Detergent . . . . 378-379
- Lawn/Leaf Bags . . . . . 417
- Leak Diverters . . . . . 604-605, 146
- Leakproof Bags . . . . . 122
- Leather Gloves . . . . . 680, 702
- Letter Opener . . . . . 107
- Lift Tables/Trucks . . 428-429, 444, 420-421
- Lifting Equipment . . 588, 592, 598, 420-429, 444
- Lighting
  - Bulbs/Accessories . . . . 658-659
  - Dock . . . . . 582, 656
  - Emergency . . . . . 657, 730, 732
  - Flashlights . . . . . 638, 729
  - Magnifiers . . . . . 753
  - Outdoor . . . . . 656
  - Retail . . . . . 211
  - Work . . 521, 523, 528, 574, 582, 729
- Line Stripers/Paint . . . . . 736-737
- Lint Rollers . . . . . 804
- Literature/Brochure Holders . . . 202-210, 656, 283
- Literature Mailers . . . . . 77-81
- Load Bars . . . . . 594
- Lock Boxes . . . . . 514, 517, 509
- Locker Room Benches . . 510, 757
- Lockers . . . . . 510-513
- Lockout/Tagout Stations . . 726-727
- Locks
  - Lockout/Tagout . . . . . 726-727
  - Padlocks . . . . . 514-515
  - Trailer . . . . . 272
  - Truck Seals . . . . . 276-278

## L

- Logistick® Load Bar . . . . . 594
- Low-Lint Wipers . . . . . 352-353, 754
- Lubricants . . . . . 798, 800-801
- Luggage Carts . . . . . 200
- Lysol® . . . . . 375, 379

## M

- Machine Guards . . . . . 576-583
- Machine Length
  - Strapping . . . . . 303
  - Stretch Film . . . . . 295-297, 288
  - Tape . . . . . 845-846
- Machine Tables . . 530, 528, 524
- Machines
  - Air Cushion . . . . . 771, 778
  - Shrink Wrap . . . . . 230, 232
  - Strapping . . . . . 303, 306, 308
  - Stretch Wrap . . . . . 294
  - Tape . . . . . 830, 832
- Magazine File Box . . . . . 666
- Magazine Racks . . . . . 202, 656
- Magic Eraser® . . . . . 374, 376
- Magliner® Hand Trucks . . 450, 656
- Magnetic
  - Badge Holders . . . . . 110
  - Clips . . . . . 635
  - Dry Erase Boards . . . . 630-634
  - Gift Boxes . . . . . 184
  - Hooks . . . . . 653
  - Labels . . . . . 650-651, 653
  - Push Pins/Discs . . . . . 634
  - Retractable Barriers . . . . 582
  - Stop Sign . . . . . 652
  - Sweeper . . . . . 373
  - Tape Dispenser . . . . . 841
  - Tape/Sheets . . . . . 650
- Magnifier Lights . . . . . 753
- Magnum Hopper Bins . . . . . 502
- Mail Carts . . . . . 462
- Mail Sorters/Workstations . . 561
- Mailboxes . . . . . 509
- Mailers . . . . . 74-108, 173, 748-749, 773, 778, 50-68
- Mailing Labels . . . . . 237-239, 263
- Mailing Tubes . . . . . 86-91, 97
- Manila Envelopes . . . . . 104-106
- Manila Folders . . . . . 108
- Manila Tags . . . . . 281-282, 285
- Marine Shrink Film/Supplies . . . 232-233
- Markers . . 640-641, 630-631, 650
- Market/Display Trays . . . 185, 196
- Marking Paint/Machine . . 736-737
- Masking Tape . . . . . 835-837, 804
- Maskout Paint . . . . . 801
- Masks . . . . . 692, 696-701, 711, 714, 716, 718
- Material Handling . . 418-645, 656
- Mats
  - Anti-Fatigue . . . . . 318-323, 328-329, 331, 755
  - Anti-Static . . . . . 755
  - Artificial Grass . . . . . 330
  - Carpet . . . . . 324-327, 329-330, 819, 317
  - Chair . . . . . 317
  - Clean . . . . . 755

## M

- Mats (cont.)
  - Drainage . . . . . 322-323, 328
  - Footbath . . . . . 328
  - Garage . . . . . 330-331
  - Gym . . . . . 329
  - Scraper . . 322, 324-327, 329-331
  - Urinal . . . . . 360
  - Waterhog™ . . . . . 325-326
  - Workbench . . . . . 523, 752, 526
- Mattress Bags . . . . . 140
- Mattress Boxes . . . . . 67
- MaxiFlex® Gloves . . . . . 678, 685
- Measuring Cups . . . . . 195
- Mechanix® Gloves . . . . . 682
- Medication . . . . . 722-725
- Merchandise Bags . . . . 160-171, 184, 198
- Merchandise Tags . . 221-225, 219
- Mesh Bags . . . . . 146, 181
- Message Boards . . . 199-201, 413
- Message Centers, Outdoor . . . . 413, 202
- Metal Detectable
  - Cable Ties . . . . . 158
  - Earplugs . . . . . 695
- Metal Stools . . . . . 414, 527
- Metal Tags . . . . . 285
- Metal Tins . . . . . 178, 182
- Metallic
  - Bags . . . . . 743-745, 54, 163, 181, 191
  - Box Liners . . . . . 50-51
  - Mailers . . . . . 103, 50-51
  - Pallet Covers . . . . . 51
  - Pouches . . . . . 188-191, 181, 184
- Microfiber
  - Mats . . . . . 326
  - Mops . . . . . 338-340, 331
  - Towels/Wipes . . 369, 348-349, 754
- Microflex® Gloves . . . . . 670
- Microwave . . . . . 386
- Milk Crates . . . . . 471, 499
- Milk Jugs . . . . . 619
- Milwaukee®
  - Backpack . . . . . 430
  - Packout™ Storage . . . 593, 430
  - Power Tools . . . . . 593
- Mini Pak'r™ Air Cushion Machine . . 771
- Minigrip® Bags . . . . . 122-123
- Mirror Window Film . . . . . 810
- Mirrors
  - Bathroom . . . . . 366
  - Safety . . . . . 586
- Misting Fans . . . . . 416, 573
- Mixing
  - Bowls . . . . . 196
  - Containers . . . . . 195-196, 618
  - Paddles . . . . . 197
  - Sticks . . . . . 386, 724
- Mobile Furniture
  - Cabinets . . . . . 494-495, 509
  - Shelving . . . . . 458-467, 483, 31
  - Tables . . . . . 524-535, 556-557, 546, 560, 263
  - Workstations . . . . . 436-439, 525-535, 556, 584

## M

Modular Drawer Cabinets . . . 494  
 Modular Seating . . . . . 549  
 Monarch® Guns/Labels . . 223-225  
 Monitor Mounts . . . . . 548, 523  
 Mops/Supplies . . 338-341, 371-375,  
 331, 380, 754  
 Moving Supplies  
 Blankets/Pads . . 64-65, 49, 788  
 Boxes/Kits . . . . . 62-68  
 Dollies/Trucks . . . . . 447-451  
 Multi-Depth Boxes . . . . . 36-37

## N

Nail Gun . . . . . 668  
 Name Badges/Lanyards . . 109-110,  
 240, 251  
 Napkins/Dispensers . . . . . 390  
 Neoprene Gloves . . . . . 676  
 Neosporin® . . . . . 725  
 Netting . . . . . 296, 480  
 Newsprint Paper . . . . . 787  
 Nitrile Gloves . . . . . 670-678,  
 684-686, 756  
 North® Respirators/Accessories . .  
 701  
 Notepads . . . . . 634-635, 97  
 Number/Letter Labels . . 264-265,  
 652-653  
 Nylon Rope . . . . . 310

## O

Office Chairs . . . . . 540-556, 560  
**Office Furniture** . . . . . 536-561,  
 630-634  
 Office Supplies . . 96-111, 630-637,  
 237, 260, 666-667, 789, 828  
 Ohaus Scales . . 661-662, 664-665  
 Oil-Dri® . . . . . 336  
 Oil/Gas Cans . . . . . 603-604  
 Olfa® Knives . . . . . 642, 644  
 Organza Ribbon/Bags . . 180-181  
 Orgapack Strapping Tools . . . . .  
 306-307, 301  
 Outdoor Furniture . . 406-417, 403  
 Outdoor Storage  
 Bins . . . . . 337, 494  
 Drop Boxes . . . . . 509  
 Flammable . . . . . 605  
 Sheds . . . . . 402, 417, 606  
 Overhead Door Track Protectors . .  
 583  
 Oxygen-Absorbing Packets . . 798

## P

Packer Bottles . . . . . 629  
**Packing List Envelopes** . . 757-762,  
 840  
 Packing Racks . . . . . 770  
 Packing Tables . . . . . 518-535, 753  
 Pad Loc™ Cushioning Pads . . 781  
 Paddles . . . . . 197  
 Padlock Seals . . . . . 278  
 Padlocks . . . . . 514-515, 726-727  
 Pads  
 Cake/Candy . . . . . 192-193  
 Chipboard . . . . . 41  
 Cleaning . . 347, 374, 376, 381, 371

## P

**Pads (cont.)**  
 Corrugated . . . . . 38-42, 192  
 Honeycomb . . . . . 42  
 Paper Moving . . . . . 64  
 Plastic Corrugated . . . . . 38  
**Pail Pumps** . . . . . 614  
**Pail Shippers** . . . . . 59-61  
**Pails/Cans** . . . . . 614-618, 59-61,  
 603-604, 380, 194  
**Pain Relievers** . . . . . 722-724

## Paint

Floor . . . . . 819  
 Maskout . . . . . 801  
 Spray . . . . . 417, 728, 736-737  
 Striping . . . . . 736-737  
**Paint Brushes** . . . . . 638  
**Paint Can Shippers** . . . . . 58-59  
**Paint Cans/Clips** . . . . . 618, 59  
**Paint Markers** . . . . . 640-641  
**Paint Rollers/Trays** . . . . . 638  
**Painter's Masking Tape** . . 835-837  
**Pallets** . . . . . 418-422, 607, 42

## Pallet

Bands . . . . . 297  
 Collars . . . . . 46  
 Cones . . . . . 314, 311-312  
 Covers . . . . . 142-143, 49, 51,  
 232, 747  
 Markers . . . . . 641  
 Pads . . . . . 38-42  
 Paper . . . . . 40  
 Positioners . . . . . 420-421, 294  
 Pullers . . . . . 588, 594  
 Roll Cradles . . . . . 780  
 Runners . . . . . 42  
 Sign Holder . . . . . 198  
 Trays . . . . . 38  
 Wrap . . . . . 286-297, 798  
**Pallet Racks** . . . . . 478-482  
 Enclosures/Netting . . . . . 480  
 Protectors . . . . . 579-580  
**Pallet Truck Scales** . . . . . 663  
**Pallet Truck Stop** . . . . . 424  
**Pallet Trucks** . . . . . 426-429, 424,  
 663, 298  
**Pamphlet Holders** . . . . . 202-210,  
 656, 283  
**Pan Racks** . . . . . 196  
**Panel Racks** . . . . . 486, 492, 496  
**Panel Trucks** . . . . . 442-443, 440  
**Pans** . . . . . 196-197, 389  
**Pants** . . . . . 708-709, 712-715

## Paper

Anti-Rust . . . . . 796  
 Anti-Slip Pallet . . . . . 40  
 Bogus . . . . . 786  
 Butcher . . . . . 785  
 Cash Register/Receipt . . 198, 241  
 Cellulose Wadding . . . 790-791  
 Crinkle . . . . . 185  
 Cushion Wrap . . . . . 789  
 Flame Retardant . . . . . 784  
 Freezer . . . . . 785  
 Gift Wrap . . . . . 182  
 Glassine . . . . . 792  
 Indented Kraft . . . . . 789  
 Kraft Rolls/Sheets . . 780-791, 796

## P

**Paper (cont.)**  
 Moving Pads . . . . . 64  
 Newsprint . . . . . 787  
 Parchment . . . . . 192  
 Plotter . . . . . 789  
 Poly Coated . . . . . 784  
 Tissue . . . . . 182-183, 787, 792  
 Toilet . . . . . 360-362, 366  
 VCI . . . . . 796  
 Waxed . . . . . 784  
**Paper Cutters** . . 782, 785, 789, 180  
**Paper Plates/Cups** . . 382-385, 389  
**Paper Shredders** . . . . . 237  
**Paper Tape** . . . . . 831-833  
**Paper Towels/Dispensers**  
 C-Fold . . . . . 355  
 Center Pull . . . . . 358, 353  
 Multi-Fold . . . . . 355-358  
 Wipers . . . . . 350-354, 380-381

## Paper Wrap . . . 780-796, 182-183

## PAPR Respirator . . . . . 700

## Parchment Paper . . . . . 192

## Parkas . . . . . 713-715

Parking Lot Repair Compounds . .  
 728

## Parking Lot Safety . . 728-739, 583

## Parking Lot Stencils . . . . . 728

## Parking Stops . . . . . 738-739, 589

## Parking/Traffic Signs . . . 730-739

Partitions . . . . . 545-549, 555, 561,  
 632, 580-581, 737

## Parts Bags . . . . . 121, 144, 147

Parts Cabinets . . . . . 516, 493-495,  
 506, 656

## Patio Furniture . . . . . 406-417, 403

## Patio Heaters . . . . . 410

## PCB Racks . . . . . 751

## Peanuts/Dispensers . . . . . 780-781

## Pedestal Fans . . . . . 571, 573, 416

Pedestal File Cabinets . . . . . 558,  
 542-553

## Pedestal Sign Holders . . 199, 201

## Pedestrian Safety Light . . . . . 582

## Pedestrian Signs . . . . . 733, 819, 821

Pegboards/Accessories . . 632-633,  
 521, 531

## Pelican™ Cases . . . . . 49

## Pens . . . . . 635

## Pest Control . . . . . 374

## Picnic Tables . . . . . 406-410, 412

## Picture Hanging Strips . . . . . 804

## Pillow Boxes . . . . . 179

Pipe Clothing Racks/Shelves . .  
 213, 208

## Pipettes . . . . . 628

## Placard Label Holders . . . . . 238

## Placards, D.O.T. . . . . 275

## Plank Foam . . . . . 776, 770

Plastic Bins . . . . . 490-509, 516, 177,  
 220, 266, 470-471, 750-751Plastic Bottles/Jars/Jugs . . 618-624,  
 629, 370

## Plastic Corrugated Pads . . . . . 38

Plastic Label Holders . . . . . 238,  
 649-650, 456, 491

## Plastic Pails . . . . . 616-618, 380, 194

## Plastic Pallets . . . . . 419-422, 607

## P

Plastic Sheets . . . . . 148-149, 38,  
 294, 746, 788, 797  
 Plastic Shelving/Racks . . 470, 465  
 Plastic Storage Boxes . . . 48, 73,  
 177, 194-197, 220, 337, 470-516  
 Plastic Tubes . . . . . 97  
 Plastic Utensils . . . . . 387, 194, 197  
 Plates, Paper . . . . . 382, 388  
 Platform Trucks . . . . . 442-445, 440,  
 450-451, 241, 431, 468  
 Plexiglas® Sheets . . . . . 788  
 Pliers . . . . . 592  
 Plotter Paper . . . . . 789  
 Plunger . . . . . 366  
 Podiums . . . . . 556, 439  
 Poly Bag Sealers . . . . . 150-155, 190  
 Poly Bags . . 112-199, 218-219, 613,  
 746-747, 797  
 Poly Box Trucks . . . . . 432, 430  
 Poly Cord Strapping . . . . . 308  
 Poly Covers . . . . . 140-145, 747  
 Poly-Dolly® . . . . . 606  
 Poly Gloves . . . . . 675  
 Poly Mailers . . . . . 94-96, 89, 100  
 Poly Sheeting . . . . . 148-149, 294,  
 746, 797  
 Poly Tubing . . . . . 150-151, 746,  
 756, 797  
 Polyester Strapping . . . . . 307-308  
 PolyJohn® Hand Wash Station . . .  
 416  
 Polyolefin Shrink Film . . 226-227  
 Polypropylene Bags . . . . . 186-190  
 Polypropylene/Cello Rolls . . 185  
 Polypropylene Strapping . . . 305,  
 309, 303  
 Ponchos/Rainwear . . 712-713, 715  
 Portable Blowers . . . . . 346  
 Portable Garage . . . . . 414  
 Portable Hand Wash Station . . 416  
 Portable Stack Racks . . . . . 483  
 Portacool® Coolers . . . . . 573  
 Portion Cups . . . . . 383  
 Post-It® Notes/Pads . . . . . 97, 634  
**Postal Approved**  
 Bags . . . . . 129  
 Strapping . . . . . 309  
**Poster Board** . . . . . 792-793  
 Posts . . . . . 730-737, 204-208, 416,  
 457, 576-581, 824  
**Pouch Tape** . . . . . 840  
**Pouches**  
 Fabric . . 144, 147, 168, 181, 778  
 Food . . . . . 186-197  
 Packing List . . . . . 757-762, 840  
**Power Breezer® Misting Fan** . . 573  
**Power Strips** . . . . . 568-569, 518, 521  
**Power Tools** . . . . . 593  
**PPE** . . 670-725, 729, 752, 756-757  
**Pressure Washer** . . . . . 417  
**Printing Guns/Fasteners** . . 222-225  
**Printers**  
 ID Card/Badge . . . . . 109, 240  
 Label/Barcode . . . . . 240-241,  
 246-251  
 Receipt . . . . . 241  
 Scale . . . . . 663



P	
Privacy Panels . . .	545-561, 632, 737
Privacy Window Film . . . . .	810
Produce Boxes . . . . .	72
Produce Mesh Bags . . . . .	146
Projecting Signs . . . . .	652-654, 602
Protection Tape . . . . .	810-811
Protective Clothing . . . . .	670-718, 729, 752-757
Protective Netting . . . . .	296, 480
Pumps . . . . .	614-615, 608
Purell®/Sanitizer . . . . .	365, 367, 381
Push Brooms . . . . .	342-343, 369
Push Carts . . . . .	434-468, 584, 241
Push Sweepers . . . . .	373, 369
PVC Shrink Film/Bags . . . . .	226-233

## Q

Quick Dam™ Flood Barriers . . 146

## R

Rack Protectors . . . . .	579-581, 480
Racks	
Baking . . . . .	196
Bar and Pipe . . . . .	486-487
Bike . . . . .	411
Cantilever . . . . .	487
Carboy Jug . . . . .	619
Clothing . . . . .	208-216, 206-207
Display . . . . .	206-217, 202-203, 656
Dunnage . . . . .	466, 470
Fork Extension . . . . .	486
Gas Cylinder . . . . .	604
Job Ticket . . . . .	656
Packing . . . . .	770
Pallet . . . . .	478-482
Panel . . . . .	486, 492, 496
PCB . . . . .	751
Reel . . . . .	486-487
Stack . . . . .	483, 609
Storage, Wide Span . . . . .	472-477, 483, 69
Test Tube . . . . .	628
Tire . . . . .	485
Tool . . . . .	417, 632-633, 638, 371-374
Raffia Ribbon . . . . .	180
Rags . . . . .	348-354, 369
Raid® Pest Control . . . . .	374
Railings . . . . .	576-583
Rain Gear . . . . .	712-713, 715, 729
Ram Board® . . . . .	788
Ramps . . . . .	449, 588, 598-599
Rapid Fill® . . . . .	778
Ratchet Tie-Downs . . . . .	590-592
Receipt Printers/Paper . . . . .	198, 241
Receiving Carts . . . . .	437
Receptacles . . . . .	395-416, 366, 372, 386
Reception Furniture . . . . .	548
Reclosable Zipper Bags . . . . .	112-123, 168, 187-192, 216, 743-746, 768, 797
Record Storage Racks . . . . .	69
Recycled Paper Bags . . . . .	160, 165
Recycling	
Containers . . . . .	403-405, 396
Light Bulb Kits . . . . .	659
Liners . . . . .	394, 405

R	
Red Rosin Paper . . . . .	788
Reel Racks . . . . .	486-487
Reflective Tape . . . . .	822-823, 276
RefrigiWear®	
Clothing . . . . .	716
Thermal Covers . . . . .	49
Rescue Blankets . . . . .	722-723
Resealable Adhesive Bags . . . . .	119, 129, 190, 187, 218-219
Respirators/Supplies . . . . .	696-701
Restocking Carts . . . . .	440, 448, 458, 374, 750
Restroom Signs . . . . .	654, 371
Retail Displays/Tables . . . . .	199-216
<b>Retail Packaging/Supplies . . . . .</b>	<b>160-225, 778</b>

## Retractable

Belt Barriers . . . . .	204-208, 416, 582
Cord Reels, Electrical . . . . .	568
Lanyards . . . . .	702-703, 110
Reusable Bulk Containers . . . . .	48, 422-425
Reusable Shopping Bags . . . . .	168, 170, 184, 54
Reverse Tuck Cartons . . . . .	73
Ribbon, Gift . . . . .	180, 182
Ribbons, Thermal Transfer . . . . .	242, 246
Road Flares . . . . .	730, 732
Roll Cradles . . . . .	780
Roll-Up Traffic Signs . . . . .	736
Roller Conveyors . . . . .	595-597
Room Dividers . . . . .	545-549, 555, 561, 632, 580-581
Rope/Twine . . . . .	310-311
Round Trip Totes . . . . .	501
Rubber Bands . . . . .	109, 297, 392
Rubber Mallet . . . . .	472
Rubbermaid®	
Bins/Totes . . . . .	194-195, 494, 503, 508
Carts/Trucks . . . . .	430-437, 352, 368
Digital Scales . . . . .	661
Janitorial Supplies . . . . .	368-375, 340, 362
Safety Barrier . . . . .	582
Smoker's Receptacles . . . . .	402
Trash Cans . . . . .	396-401, 403-405
Rugs . . . . .	324-327, 819, 317, 330

## S

S-Hooks . . . . .	204
Safes . . . . .	517
<b>Safety</b>	
Apparel . . . . .	670-718, 729, 757
Barriers . . . . .	576-585, 730-739, 146, 204-205, 208, 416, 824
Bollards . . . . .	578-579
Cabinets . . . . .	600-605, 726
Compliance Centers . . . . .	726
Cones . . . . .	732-735, 371
Curbs . . . . .	580, 738-739
Ear Protection . . . . .	694-695
Eyewash . . . . .	719-721
Fences . . . . .	730, 737, 584-585
Fire/Flammable . . . . .	600-605
First Aid . . . . .	722-725, 719-721

S	
Safety (cont.)	
Glasses/Wipes . . . . .	688-693, 700
Gloves . . . . .	670-687, 702, 752, 51
Harnesses . . . . .	702-703
Knives . . . . .	644, 107, 180, 286, 642
Lights . . . . .	582, 657, 730-734, 729
Locks/Seals . . . . .	726-727, 272, 276-278
Mirrors . . . . .	586
Tape . . . . .	818-826, 276
Toe Covers . . . . .	729
Vests . . . . .	714-718
Wash Bottles . . . . .	628
Saline Solution . . . . .	720-721
Salvage Drums . . . . .	605, 607
Sandbags . . . . .	146
Sanding Hand Pads . . . . .	374
Sanitary Napkin Receptacles . . . . .	366
Sanitizer . . . . .	365-367, 375-379, 381, 353
Satin Bags/Ribbon . . . . .	181-182
Sauce Bottles . . . . .	623-626
<b>Scales . . . . .</b>	<b>660-665, 294</b>
Scanners, Barcode . . . . .	250
Scissor Lift Trucks . . . . .	428-429
Scissors . . . . .	635, 642
Scoops . . . . .	146, 194, 337
Scotch-Brite™ Pads/Sponges . . . . .	381
Scotch® Tape . . . . .	828-829, 846-847, 836
Scraper Mats . . . . .	322-331
Scrapers	
Boot/Shoe . . . . .	330
Floor . . . . .	338
Food Service . . . . .	194
Knife . . . . .	88, 643
Window . . . . .	341, 372
Screens	
Fence/Privacy . . . . .	737, 730
Partitions . . . . .	545-549, 555, 561, 632, 580-581, 737
Urinal . . . . .	360
Welding . . . . .	686
Screwdrivers . . . . .	592
Scrubs . . . . .	708
SDS Compliance Centers . . . . .	726
Sealers	
Poly Bag . . . . .	150-155, 190
Shrink Wrap . . . . .	230, 232
Strapping . . . . .	298-308
Vacuum/FoodSaver® . . . . .	197, 152
Seals, Security . . . . .	276-278, 272
Security	
Cages . . . . .	458, 464-465, 480
Carts . . . . .	458, 465, 584, 438-440
Gates . . . . .	584-585, 577, 580-583
Labels . . . . .	260, 844
Locks . . . . .	514-515, 726-727
Rooms . . . . .	580-581
Seals . . . . .	276-278, 272
Tape . . . . .	834, 842, 844
Ties . . . . .	158
Service Carts . . . . .	467-468, 434-441, 526, 368
Shadow Boards . . . . .	373
Sharpie® Markers . . . . .	640-641

S	
Sharps Containers . . . . .	724
Sheds . . . . .	402, 417, 606
Sheet Rack . . . . .	486
Sheets	
Bed . . . . .	368
Corrugated . . . . .	38-41
Foam . . . . .	770-776, 639
Hardboard . . . . .	788
Honeycomb . . . . .	42
Plastic . . . . .	148-149, 38, 294, 746, 797
Plexiglas® . . . . .	788
Shelf Liners . . . . .	456
Shelters . . . . .	414-416
Shelving	
Bathroom . . . . .	366
Bin Organizers . . . . .	492-499, 656, 458, 460, 464
Boltless . . . . .	470-485, 69
Carton Stands . . . . .	31
Epoxy Wire . . . . .	465-466
Laminate . . . . .	474
Mobile . . . . .	458-467, 483, 494-495, 31
Pallet Racks . . . . .	478-482
Plastic . . . . .	470, 465
Portable Stack Racks . . . . .	483
Retail . . . . .	206-215
Sliding . . . . .	463
Stainless Steel . . . . .	467-469
Steel . . . . .	471-485, 69
Tire Racks . . . . .	485
Tool Racks . . . . .	417, 632-633, 638, 371-374
Wall-Mount . . . . .	464, 467, 208-215, 638
Wide Span . . . . .	472-477, 483, 69
Wire . . . . .	452-469, 495-498
Shelving Accessories . . . . .	456-460, 206-212
Shippers	
Anti-Static . . . . .	742-749, 84
Artwork . . . . .	68-69, 74-76, 773
Foam . . . . .	53-59, 68, 84, 748-749, 773, 778
Hazmat . . . . .	58-61
Insulated . . . . .	49-55, 31
Pail/Can . . . . .	58-61
Wine . . . . .	55-56
Shipping Forms/Tabs . . . . .	270, 272
<b>Shipping Indicators . . . . .</b>	<b>798-799</b>
Shipping Labels . . . . .	252-275, 238
Shirts . . . . .	708-709, 714-715
Shockwatch® Indicators . . . . .	799
Shoe/Boot	
Boxes . . . . .	176-177
Covers . . . . .	704-713, 729, 757
Scrapers . . . . .	330
Toe Covers . . . . .	729
Trays . . . . .	326, 328
Shop Desks . . . . .	531, 524-525
Shop Stools . . . . .	526-534, 518, 522
Shop Towels . . . . .	348-354, 369
Shopping Bags . . . . .	160-171, 184, 198-199
Shopping Carts/Baskets . . . . .	220
Shovels . . . . .	337

**S**

Shower Cap . . . . . 711  
**Shrink Wrap** . . . . . 226-233, 798  
 Shrink Wrap Sealers . . . 230, 232  
 Sign Holders . . . 198-210, 222, 653  
 Sign Posts/Bases . . . 728-731, 736  
**Signs**  
 A-Frame/Sidewalk. . . . 199-201  
 AED . . . . . 654  
 Aisle . . . . . 652-653, 821  
 Crowd Control . . . 205, 824, 821  
 Dock Door . . . . . 652  
 Exit . . . . . 655, 657, 821, 205  
 Eyewash . . . . . 719, 654  
 Fire Extinguisher . . . . 602,  
 654-655, 657, 652  
 Floor . . . . . 819-823, 371  
 Glow in the Dark. . . . . 657  
 Message Center/Trail Sign . . 413  
 Parking . . . . . 730-736, 739  
 Pedestrian . . . . . 733, 819, 821  
 Restroom . . . . . 654, 371  
 Spill Kit . . . . . 654  
 Stop . . . . . 730-731, 733, 652, 821  
 Traffic . . . . . 730-736, 819-821  
 Warehouse . . . 652-657, 821, 371  
 Wet Floor. . . . . 371  
**Silica Packets** . . . . . 794-795  
**Silver Saver**® . . . . . 796  
**Simple Green**® . . . . . 376-377, 379  
**Simplehuman**® . . . . . 398-401  
**Sink Worktables** . . . . . 532, 535  
**Sit/Stand**  
 Desks/Risers . . . 555-557, 547, 551  
 Stools . . . . . 522  
 Workbenches . . . . . 522  
**Size Labels/Markers** . . . . 218-219  
**Slatwall Supplies** . . . 210-212, 638  
**Sleeves** . . . . . 675-676, 684, 686,  
 706-707, 709, 718  
**Slice**® Cutters. . . . . 88, 107  
**Slim Jim**® Containers. . . 396, 405  
**Slip Sheets** . . . . . 38-41  
**Smoker's Receptacles** . . . 402-403  
**Snap Edge Signs** . . . . . 200-201  
**Snow Brush** . . . . . 372  
**Snow Shovels** . . . . . 337  
**Soap/Dispensers** . . . 362-366, 356  
**Software, Barcode** . . . . . 246  
**Solder Wire** . . . . . 750  
**Sorbents** . . . . . 332-336, 330  
**Soundproofing Foam** . . . . . 789  
**Soup Containers** . . . . . 389  
**Space Age Totes** . . . . . 501  
**Specimen Bags** . . . . . 122-123  
**Speed Bumps** . . . . . 738-739, 732  
**Speed Pack Box** . . . . . 63  
**Spice Jars** . . . . . 622  
**Spill Containment** . . . . 332-336,  
 604-608, 146, 371  
**Spin Mop** . . . . . 331  
**Sponges** . . . . . 374, 381, 376, 380  
**Spray Adhesives** . . . . . 800-801  
**Spray Bottles** . . . . . 370, 623, 629  
**Spray Paint** . . . . . 417, 736-737, 728  
**Spray Sock** . . . . . 711  
**Squeegees** . . . . . 340-341, 347, 372  
**Stack and Nest Totes** . . . 498-502

**S**

**Stack Racks** . . . . . 483, 609  
**Stackable Chairs** . . . . . 539, 543,  
 549, 554, 556  
**Stackable/Shelf Bins** . . . 488-492,  
 498-503, 750  
**Stackers, Straddle** . . . . . 428  
**Stainless Steel**  
 Benches, Gowning . . . . . 757  
 Bowls . . . . . 196  
 Cabinets. . . . . 508, 742  
 Carts . . . . . 441, 465-468  
 Cleaners . . . . . 376  
 Dolly . . . . . 613  
 Drums/Pumps . . . 610, 609, 615  
 IBC Tank . . . . . 609  
 Lift Tables . . . . . 444  
 Paddles . . . . . 197  
 Padlocks . . . . . 514  
 Pallet Truck . . . . . 424  
 Scales . . . . . 660-665  
 Shelving . . . . . 467-469  
 Strapping . . . . . 302  
 Tables . . . . . 532-535, 519,  
 529-530, 444  
 Trash Cans . . . 400-401, 399, 353  
 Utility Sink . . . . . 535  
**Stair Climbers/Hand Trucks** . . . . 447-451, 442, 656  
**Stair Treads** . . . . . 328, 819-820  
**Stake Flags** . . . . . 737  
**Stand-Up Pouches** . . . . . 188-193  
**Staplers/Supplies** . . . . . 666-669, 144  
**Static Control** . . . . . 740-755  
**Stationery Boxes** . . . . . 177, 72  
**StayFlats**® . . . . . 98-100  
**Steamers, Garment** . . . . . 216  
**Steel Mesh Glove** . . . . . 675  
**Steel Strapping** . . . 298-302, 309  
**Steel Toe Shoe Covers** . . . . . 729  
**Stencils, Parking Lot** . . . . . 728  
**Step Ladders/Stools** . . . 562-567,  
 373  
**Sterilite**® . . . 470, 177, 220, 266, 516  
**Sticky Notes** . . . . . 97, 634  
**Stock Picker Carts** . . . . 440, 448,  
 458, 374  
**Stools/Chairs** . . . . . 518-560, 410,  
 412, 414, 470, 753  
**Stop Signs** . . . 730-731, 733, 652, 821  
**Storage**  
 Bins . . . 488-516, 656, 194-197, 220  
 Cabinets. . . 504-509, 632, 348,  
 493-495, 656  
 Flammable/Corrosive. . . 600-605  
 Food . . . . . 186-199  
 Sheds . . . . . 402, 417, 606  
**Straddle Stackers** . . . . . 428  
**Straight Wall Containers** . . 499, 484  
**Strapping**  
 Carts . . . . . 298-301, 304-306  
 Guards/Protectors. . . . . 313  
 Machines . . . . . 303, 306, 308  
 Materials. . . . . 299-311  
 Tape . . . . . 838-839, 841  
 Tools . . . . . 298, 300-309  
**Stretch Loops, Retail** . . . . . 180  
**Stretch Netting** . . . . . 296

**S**

**Stretch Wrap**  
 Dispensers . . . . . 286, 293-295  
 Machines/Turntables . . . . . 294  
 Wrap . . . . . 286-297, 798  
**String Lights** . . . . . 574  
**String Ties** . . . . . 280-281  
**Strip Doors** . . . . . 587, 584  
**Stripping Paint/Machine** . . 736-737  
**Suction Cups** . . . . . 222  
**Suffocation Warning Bags/**  
**Labels** . . . . . 219, 273, 140  
**Sugar** . . . . . 386  
**Sunscreen** . . . . . 722  
**Supply Cabinets** . . . 504-509, 632,  
 348, 493-495, 656  
**Surge Protectors** . . . . . 568-569  
**Swabs, Cleanroom** . . . . . 754  
**Swamp Coolers** . . . . . 573  
**Sweeping Brooms** . . . . 342-343,  
 369, 380  
**Sweeping Compounds** . . . . 336  
**Swiffer**® . . . . . 340, 375  
**Swing Gates** . . . . . 580-585, 577

**T**

**T-Shirt Bags** . . . . . 166-170, 198  
**T-Shirt Rags** . . . . . 348-349  
**Table Dollies** . . . . . 538-539  
**Tablecloths** . . . . . 390, 539  
**Tables**  
 Café/Cafeteria . . . . . 543, 546,  
 560, 410, 412, 539  
 Conference . . . . . 543-552  
 Display . . . . . 206, 213  
 ESD . . . . . 753  
 Folding . . . . . 536-539, 534, 557,  
 546, 560, 263, 526  
 Lifting . . . . . 429, 444, 420-421  
 Mobile . . . . . 524-535, 556-557,  
 546, 560, 263  
 Office . . . . . 543-560  
 Picnic . . . . . 406-412  
 Stainless Steel. . . 532-535, 519,  
 529-530, 444  
 Training/Seminar. . . 557, 539, 546  
 Workbenches . . . . 518-535, 753  
**Tagging Guns** . . . . . 222-225  
**Tags** . . . . . 279-285, 158, 221, 244,  
 602, 719, 727  
**Take-Out Bags/Boxes** . . 198-199,  
 160-168, 388-389

**Tape**  
 3M . . . 803-816, 824-829, 834-847  
 Adhesive Transfer/ATG. . . . .  
 808-809, 803, 806  
 Aisle Marking . . . . . 821-825, 819  
 Aluminum Foil . . . . . 816  
 Anti-Slip . . . . . 819-821, 823  
 Anti-Static . . . . . 748  
 Bag . . . . . 138  
 Barricade . . . . . 818  
 Carpet/Protection. . . . 810-811  
 Carton Sealing . . . . . 850-851,  
 841-849, 828-834  
 "Caution" . . . . . 818-825  
 Cleanroom . . . . . 756  
 Colored . . . . . 818-843, 138

**T**

**Tape (cont.)**  
 Conspicuity . . . . . 276, 822  
 Crystal Clear. . . . . 828-829, 841  
 Custom Printed . . . . . 843  
 Double-Sided. . . . . 803-810  
 Dual Lock™ . . . . . 814  
 Duct . . . . . 827, 814  
 Electrical. . . . . 826  
 ESD . . . . . 748  
 Fiberglass . . . . . 816, 154  
 Filament . . . . . 838-839  
 Flagging . . . . . 818  
 Foam . . . . . 804-807  
 Freezer . . . . . 823  
 FrogTape® . . . . . 835  
 Gaffer's . . . . . 826  
 Glow in the Dark. . 822-823, 276  
 Gorilla . . . . . 814  
 Hook and Loop . . . . . 812-815  
 Hull . . . . . 233  
 Kapton® . . . . . 816  
 Kraft . . . . . 831-833  
 Label Protection . . . . . 840, 822  
 Machine Length. . . . . 845-846  
 Magnetic . . . . . 650  
 Masking . . . . . 835-837, 804  
 Message. . . . . 818-824, 831, 834,  
 842-844, 826  
 Nashua . . . . . 827  
 Office . . . . . 828, 837  
 Painter's . . . . . 835-837  
 PET . . . . . 816  
 Polypropylene . . . . . 842-846  
 Pouch . . . . . 840  
 Protection . . . . . 810-811, 822  
 PVC . . . . . 822-823, 843-844  
 Quiet. . . . . 841, 844  
 Reflective . . . . . 822-823, 276  
 Safety . . . . . 818-826, 276  
 Scotch® . . . 828-829, 846-847, 836  
 Security. . . . . 834, 842, 844  
 Shapes . . . . . 821-823  
 Shrink . . . . . 233  
 Silent. . . . . 841, 844  
 Strapping . . . . . 838-839, 841  
 Teflon® . . . . . 816, 154  
 Velcro® . . . . . 812-815  
 VHB™ . . . . . 806-807  
 Window Protection . . . . 810-811  
**Tape Dispensers** . . . . . 808-848  
**Tape Floor Applicators** . . . . 823,  
 825, 811  
**Tape Machines** . . . . . 830, 832  
**Tape Measures** . . . . . 636  
**Tarps** . . . . . 145, 818, 148-149, 604  
**Task Lights** . . . . . 753, 528  
**Temperature Indicators** . . . . 798  
**Tensabarrier**® . . . . . 205  
**Tents** . . . . . 414-416  
**Test Tubes and Racks** . . . . . 628  
**"Thank You" Bags** . . . 167-168, 198  
**Thermal Clothing** . . . . . 714, 716,  
 676, 683  
**Thermal Food Bags** . . . . . 54  
**Thermal Pallet Covers** . . . . 49, 51  
**Thermal Printers** . . . . . 241-251  
**Thermal Shippers** . . . . . 49-55, 31

<b>T</b>	<b>T</b>	<b>V</b>	<b>W</b>
Thermal Transfer Labels/ Ribbons . . . . . 241-251	Trash Cans (cont.) Countertop . . . . . 386 Drive-Thru . . . . . 372 Dumping Hoppers . . . 423, 431 Mobile . . . . . 404-405, 399, 430-433 Office . . . . . 399-401, 396-398 Oily Waste . . . . . 603 Outdoor . . . . . 402-416, 396-399, 372 Recycling . . . . . 403-405, 396 Simplehuman® . . . . . 399-401 Smoker's Receptacles . . 402-403 Stainless Steel . . . . . 400-401, 399, 353	Vacuum Sealer/Bags . . . 197, 152 Vacuums . . . . . 344-348, 372-373, 369 Vaseline® . . . . . 725 VCI Products . . . . . 796-798 Velcro® Tape/Straps. . . . . 812-815 Velvet Pouches . . . . . 181 Velvet Rope Crowd Control . . 205 Vent Hole Bags . . . . . 116, 218-219 Vermiculite . . . . . 780 Versaflo™ PAPR Respirator . . 700	Window Protection Film . . 810-811 Window Washers . . . . . 340-341, 372 Windsock . . . . . 737 Wine Bags . . . . . 170-171, 181, 160-163, 165 Carriers . . . . . 55-56, 164, 170 Shippers . . . . . 55-56 Wipers . . . . . 348-369, 374-381, 390, 754
Tissue Facial . . . . . 357 Packing . . . . . 787, 792 Retail . . . . . 182-183, 787, 792 Toilet . . . . . 360-362, 366	Trash Liners . . . . . 392-399, 403, 405, 410-413, 417, 613	Vests Cooling . . . . . 718 Safety . . . . . 714-718	Wire Baling . . . . . 303 Bins . . . . . 206, 424, 498 Brushes . . . . . 374 Carts . . . . . 457-468, 438, 748, 31, 97, 220, 464 Containers . . . . . 424, 206 Cutters . . . . . 277-278 Decking . . . . . 476-478, 481-482 Machine Guards . . . . . 580 Security Rooms . . . . . 580-581 Shelving . . . . . 452-469, 495-498 Solder . . . . . 750 Ties . . . . . 280-281, 138-139
Toe Covers . . . . . 729	Trash Pickers . . . . . 417	VHB™ Tape . . . . . 806-807	Wine Baling . . . . . 303 Bins . . . . . 206, 424, 498 Brushes . . . . . 374 Carts . . . . . 457-468, 438, 748, 31, 97, 220, 464 Containers . . . . . 424, 206 Cutters . . . . . 277-278 Decking . . . . . 476-478, 481-482 Machine Guards . . . . . 580 Security Rooms . . . . . 580-581 Shelving . . . . . 452-469, 495-498 Solder . . . . . 750 Ties . . . . . 280-281, 138-139
Toilet Brush . . . . . 366	Trauma Kits . . . . . 722-723	Vials . . . . . 628	Wood Crates . . . . . 46-47
Toilet Seat Covers/Dispensers . . 362	Trays Corrugated . . . . . 48, 12, 38, 185 ESD/Kitting . . . . . 751 Food Service . . . . . 196 Spill Containment . . . . 606-608	Vinegar, Cleaning . . . . . 378	Wood Pallets . . . . . 418, 420
Tongue Depressors . . . . . 724	Triple Wall Boxes . . . . . 45, 42, 48, 61, 63	Vinyl Envelopes . . . . . 648 Gloves . . . . . 675 Job Ticket Holders . . . . 646-648 Labels/Signs . . . . . 651-655, 270 Strip Door Kits . . . . . 587, 584 Tag Protectors . . . . . 279 Tape . . . . . 824-826 Zipper Bags . . . . . 216, 648	Woozy Bottles . . . . . 625
Tool Storage Bag/Backpack . . . . . 636, 430 Cabinets . . . . . 494, 632, 639 Carts . . . . . 639, 584, 632, 436, 593 Drawer Organizers . . . . . 639 Racks . . . . . 417, 592, 632-633, 638, 371-374 Toolboxes . . . . . 593, 639, 818, 470 Work Belt . . . . . 849	Truck Placards . . . . . 275	Void Fill . . . . . 763-791, 182-185	Work Belt . . . . . 849 Boots . . . . . 729, 713 Gloves . . . . . 670-687, 702, 756, 752 Lights . . . . . 521, 523, 528, 574, 582, 729, 753 Platforms . . . . . 562-565
Tools . . . . . 592-593, 636-639, 277-278, 298-309	Truck Seals . . . . . 276-278, 272	Vornado® Fans . . . . . 535, 568, 571, 34	Work Height Platform Trucks . . 442
Top Sheeting . . . . . 294	Trucks, Warehouse . . . . . 424-433, 440-451, 468, 610, 656, 663	Vornado® Heater . . . . . 568	Workbench Mats . . . . . 523, 752, 526
Tork® Systems Bath Tissue . . . . . 361, 366 Napkin . . . . . 390 Soap . . . . . 356 Towel . . . . . 356-358	Tubes . . . . . 86-91, 97		Workbenches . . . . . 518-535, 753
Tote Bags . . . . . 168, 184	Tubing Anti-Static . . . . . 746 Cleanroom . . . . . 756 Cushioning . . . . . 770, 763 Poly . . . . . 150-151 Shrink . . . . . 229 VCI . . . . . 797	<b>W</b>	Workplace Signs . . . . . 652-657, 819-824, 371
Tote Dollies . . . . . 501	Turntables . . . . . 294, 420-421	Wafer Seals . . . . . 237, 239	Workstations Carts . . . . . 436-439, 526, 584 Office . . . . . 542-555, 561 Spill Containment . . . . . 607 Warehouse . . . . . 518-535, 753
Tote Picking Cart . . . . . 448	TV Boxes . . . . . 63	Walk Ramps . . . . . 449	Wrapping Paper/Supplies . . . . . 180-185, 787, 792
Totes . . . . . 498-509, 516, 65, 177, 220, 266, 470-471, 484	TV Stand, Mobile . . . . . 439	Wall Clocks . . . . . 637	Wreath Boxes . . . . . 173
Towels/Wipes . . . . . 348-369, 374-381, 390, 718, 754	Tweezers, ESD . . . . . 750	Wall Mount Cabinets . . . . . 508 Fans . . . . . 570, 573, 582 Shelving . . . . . 464, 467, 208-215, 638 Workbenches . . . . . 531, 526	Wrenches Drum Plug . . . . . 614 IBC Tank . . . . . 608 Pail . . . . . 617 Tool Sets . . . . . 639, 592
Traffic Safety Apparel . . . . . 712-718, 729 Barricades . . . . . 730-739, 583 Baton . . . . . 732 Cones . . . . . 732-735 Fleet Safety Kit . . . . . 730 Parking Stops . . . . . 738-739, 589 Signs . . . . . 730-736, 739 Speed Bumps . . . . . 738-739, 732 Striping Paint/Machine . . 736-737 Tape . . . . . 818-826, 276 Warning Triangles . . . . . 730	Tylenol® . . . . . 724	Wall Pack Lights . . . . . 656	Wristbands, Tyvek® . . . . . 285
Trailer Jacks . . . . . 598	Tyvek® Envelopes . . . . . 101 Liner Rolls . . . . . 786 Protective Clothing . . . . 709 Tags . . . . . 279, 282 Wristbands . . . . . 285	Wardrobe Boxes . . . . . 62, 64	WypAll® Wipers . . . . . 350-352, 354
Trailer Locks . . . . . 272	TZe P-Touch® Label Tape . . . 240	Warehouse Cabinets . . . . . 507, 348	
Training Tables . . . . . 557, 539, 546		Warehouse Signs . . . . . 652-655, 657, 819-821, 371	
Trash Can Bands . . . . . 392	<b>U</b>	Waste Receptacles . . . . . 395-416, 372, 386, 366	
Trash Can Dollies . . . . . 396-397, 404	U-Boat Platform Trucks . . 442, 444	Water Bottle . . . . . 391	
<b>Trash Cans</b> Biohazard . . . . . 395, 404 Brute® . . . . . 397, 404-405 Bulk Trucks . . . . . 430-433, 423 Corrugated . . . . . 403	Umbrella Bags . . . . . 204	Water-Wall™ Barriers . . . 734, 730	
	Umbrellas, Patio . . . . . 406	Waterhog™ Mats . . . . . 325-326	
	Urinal Supplies . . . . . 360	Waxed Paper . . . . . 784	
	Utensil Dispensers . . . . . 387	WD-40® . . . . . 801	
	Utensils . . . . . 387, 194, 197	Weatherproof Labels . . . 239, 244, 251, 270	
	Utility Carts . . . . . 434-448, 457-468, 584, 208, 241, 368	Welding Screens . . . . . 686	
	Utility Knives . . . . . 642-645, 51, 88, 107, 229, 785, 829, 835, 844	Wet Erase Markers . . . . . 650	
	Utility Totes . . . . . 509	Wet Floor Signs . . . . . 371	
	Utility Trays . . . . . 606	Wet Mops . . . . . 339-340, 331, 375, 380	
	Uvex® Safety Glasses . . . . . 691	Wheel Chocks . . . . . 589	
	UVI Pallet Covers . . . . . 142, 818	Wheel Riser Ramps . . . . . 588	
	UVI Shrink Film . . . . . 232-233	Wheels . . . . . 446, 450-451, 457	
	UVI Stretch Wrap . . . . . 288, 290	Whirl-Pak® Bags . . . . . 122	
		Whiteboards . . . . . 630-632, 634, 201	
		Wide-Mouth Jars . . . . . 620-621, 625, 627	
		Wide Span Storage Racks . . . . . 472-477, 483, 69	
		Windex® . . . . . 379	



**TOOLS FOR HIM**



**TAPE MEASURE**

Extra-wide tape extends 25' without assistance.

- Magnetic tip and bright LED. Lithium-ion battery.

**CORDLESS DRILL AND DRIVER KIT**

Quick charge lithium-ion battery has 40% more runtime.

- Lightweight and rugged with built-in LED light.

Kit Includes: M18™ compact 1/2" drill driver, M18™ 1/4" hex impact driver, two M18™ compact REDLITHIUM™ batteries, M18™ and M12™ multi-voltage charger and one belt hook.

**JOB SITE RADIO**

The most advanced radio built for the job site.

- 10 speakers for 360° detailed sound.
- Bluetooth® compatible up to 100 feet away.

\* Fits Packout™ Storage System, page 593

MODEL NO.	DESCRIPTION	PRICE EACH	Free with a Uline order of
H-10897	Tape Measure	\$40	\$750+
H-6113	Cordless Drill and Driver Kit	265	\$5,000+
H-10896*	Job Site Radio	440	\$10,000+

**STANLEY® CLASSIC BOTTLES**



Rugged style that keeps coffee, tea or soup piping hot.

- Stays hot for 40 hours, cold for 35 hours.
- Double-wall insulated stainless steel.
- Lid doubles as a cup. Collapsible handle.

Dishwasher safe SPECIFY COLOR: Black or Orange

MODEL NO.	DESCRIPTION	SIZE	PRICE EACH	Free with a Uline order of
S-24857	Classic Bottle	48 oz.	\$50	\$750+

**YETI® KNIT HATS**

Stay warm on the job or your next winter getaway!

- Ultra comfortable fabric. 100% stretch acrylic.
- Large front patch Yeti® logo. Unisex.
- Machine washable.



SPECIFY COLOR: Black or Gold

MODEL NO.	DESCRIPTION	SIZE	PRICE EACH	Free with a Uline order of
S-25021	Knit Hat	One Size	\$30	\$500+

**PORTABLE LED WORK LIGHT**



Shine this light right where you need it. Cordless and rechargeable.

- Two brightness settings.
- Adjustable stand and built-in magnets.

Lithium-ion battery Includes USB cable

MODEL NO.	DESCRIPTION	SIZE L x W x H	LUMENS	WT. (LBS.)	PRICE EACH	Free with a Uline order of
H-10115	Portable Light	2 x 8 x 5"	500	1	\$40	\$500+

**JUMPER CABLES**

Essential equipment for truck drivers, couriers and moms.

- Thick, 2-gauge wires.
- Inline voltmeter checks battery life.



MODEL NO.	DESCRIPTION	CABLE LENGTH	WT. (LBS.)	PRICE EACH	Free with a Uline order of
H-9514	Jumper Cables	20'	9	\$45	\$750+

# THE DIFFERENCE BETWEEN THE AMERICAN DREAM AND AMERICAN VALUES



What is the American Dream? Most people say it's a spouse, kids, a good job and a nice house with a big yard. It's a belief that if you work hard, you can build a better life for your family. That dream is the reason people around the world have always come to America.

What are American Values? Uh oh...ask people what American values we can agree on, and it falls apart. Today, we are a very splintered country. Seemingly, we have four political groups: far left, center left, center right and far right.

## WHAT – IF ANYTHING – CAN WE AGREE ON?

**FREEDOM** – Life, liberty and the pursuit of happiness. Equal opportunity for everyone. Freedom. We seem to pretty much agree on.

**CRIME** – Violent crime is a serious issue. The best cultural, academic institutions and medical facilities are usually in our big cities. Businesses are leaving due to constant, large-scale theft and crime. Will these all deteriorate?

**HOMELESS** – Should they be allowed to live on the streets or not? If so, where?

**DRUGS** – Marijuana was illegal for many years. We were told it was a gateway drug. Today, almost 45% of our population is using marijuana in some form or another. Marijuana impairs your ability to think quickly, weakens your motor skills and can affect your memory.

**GAMBLING** – It seems now anything goes. You can gamble at the casino, on your phone and online. You can bet on any football game right from your couch. Is this what we want for our children?

**IMMIGRATION REFORM** – This country was built on legal immigration. Immigrants are an asset. Open border policy with no legality is causing untold issues in our country.

**ENERGY POLICIES** – Full speed ahead on solar power and electric vehicles? Or can we be smarter? If we are not careful, we will be having rolling blackouts. In addition, China is building 136 coal plants and manufacturing 97% of solar wafers. Meanwhile, American politicians are talking about banning gas stoves.

**ELECTIONS** – Yet another election! The candidate you like best in the primary might not be the one that can win in the general election. Voting in primary elections deserves much more thought.

What a mess. Stay calm, take a deep breath and try to do the best you can.



*Liz Uihlein*

## OUR PEOPLE MAKE THE DIFFERENCE





# FREE OFFERS

# FREE UPON REQUEST WITH ANY ULINE ORDER OF...

## T-SHIRTS



Good choice for a cookout or tailgate party.

- Comfortable 100% cotton.
- Vibrant screen-printed graphics.
- Machine washable.

MODEL NO.	DESCRIPTION	TEAM	SIZE	PRICE EACH	Free with a Uline order of
S-24721	NFL T-Shirt	All Teams	M - 2XL	\$30	\$300+
S-24472	MLB T-Shirt	All Teams	M - 2XL	\$30	\$300+

Specify team. Styles may vary. Imported.

## SPORTS CAPS



Toss on your favorite team cap. Adjustable closure.

- All NFL and MLB teams available.

MODEL NO.	DESCRIPTION	TEAM	SIZE	PRICE EACH	Free with a Uline order of
S-24705	NFL Sports Cap	All Teams	M - 2XL	\$30	\$300+
S-24478	MLB Sports Cap	All Teams	M - 2XL	\$30	\$300+

Specify team. Styles may vary.

## NFL HENLEYS



Add a warm layer for those cold night games.

- Textured waffle weave with button closure.
- Lightweight, cotton/polyester blend.
- Machine washable.

MODEL NO.	DESCRIPTION	TEAM	SIZE	PRICE EACH	Free with a Uline order of
S-25077	NFL Henley	All Teams	M - 2XL	\$50	\$750+

Specify team. Styles may vary. Imported.

## NFL HOODIES

Easy to throw on for game day.

- Drawstring hood with pass-through pocket.
- Heavyweight, 100% polyester.
- Machine washable.



MODEL NO.	DESCRIPTION	TEAM	SIZE	PRICE EACH	Free with a Uline order of
S-21215	NFL Hoodie	All Teams	M - 2XL	\$50	\$750+

Specify team. Styles may vary. Imported.

## NFL ROLLING COOLERS



Nothing's cooler than showing off your favorite team.

- Holds up to 30 cans.
- Two mesh side pockets and one zippered front pocket.
- Telescopic handle and durable roller wheels.

MODEL NO.	DESCRIPTION	TEAM	SIZE L x W x H	PRICE EACH	Free with a Uline order of
S-20421	NFL Rolling Cooler	All Teams	14 x 16 x 21"	\$60	\$750+

Specify team. Styles may vary.

## NFL CLASSICS

NFL Blanket – Stay warm in the stands or at home.

- Extra large and cozy.

NFL Football – Go deep! Play catch with friends.

- Composite leather with synthetic laces.



HUGE 60 x 80"

MODEL NO.	DESCRIPTION	TEAM	SIZE	PRICE EACH	Free with a Uline order of
S-25490	NFL Football	All Teams	Official	\$35	\$300+
S-25475*	NFL Blanket	All Teams	60 x 80"	50	\$500+

Specify team. Styles may vary.

\* Imported. Machine washable.



## ADVENTURE AWAITS



**Backpack** – Holds a 16" laptop and 10" tablet.

- 5 zippered compartments and 15 pockets.

**Hardside Carry-On** – Extra secure with 3-digit lock.

- Lightweight and tough, polycarbonate construction.

**Business Case** – Padded laptop and tablet compartment.

- Rugged polyester exterior. 2 in-line wheels.



**WENGER/SWISSGEAR®**

MODEL NO.	DESCRIPTION	SIZE W x H x D	WT. (LBS.)	PRICE EACH	Free with a Uline order of
S-20987	Laptop Backpack	14 x 19 x 12"	3	\$90	\$1,500+
H-8805	Hardside Carry-On	14 x 24 x 10"	7	150	\$2,500+
H-10881	Business Case	17 x 14 x 9"	9	155	\$2,500+

## WEEKENDER TOTES



Roomy carryall for work, travel and overnight trips.

- Thick polyester fabric. Zip closure with 1 exterior pocket.
- 4 interior pockets. Keep small items organized.
- Attaches easily to your rolling suitcase handle.

SPECIFY COLOR: Red/Navy or Black/Gray

MODEL NO.	DESCRIPTION	SIZE L x W x H	PRICE EACH	Free with a Uline order of
S-24968	Weekender Tote	19 x 9 x 14"	\$45	\$500+

## JUMBO OUTDOOR BLANKETS

Your go-to blanket for outdoor concerts, fireworks and picnics.

- **Waterproof** polyester exterior with soft fleece interior.
- Rolls up and secures with straps. Convenient built-in handle.
- Machine washable.



HUGE 72 x 80"

SPECIFY COLOR: Red or Green

MODEL NO.	DESCRIPTION	SIZE	PRICE EACH	Free with a Uline order of
S-24374	Jumbo Outdoor Blanket	72 x 80"	\$50	\$500+

Imported

## HYDRO FLASK® BOTTLES



Stay hydrated as you hike, camp or enjoy a beachside picnic.

- Carry it everywhere with a 5/8" soft silicone handle.
- Drinks stay cold for 24 hours or hot for 12.
- Extra-wide mouth for easy sipping, filling and cleaning.

Dishwasher safe

SPECIFY COLOR: Black or White

MODEL NO.	DESCRIPTION	SIZE	PRICE EACH	Free with a Uline order of
S-24372	Wide-Mouth Bottle	32 oz.	\$55	\$1,000+

## UE WONDERBOOM SPEAKERS

Miniature boom box rocks the house or outdoor party.

- Floats. Submersible up to 30 minutes.
- Big, bold 360° sound with plenty of bass.
- Connects to Bluetooth®-enabled devices up to 100 feet away.



BLUETOOTH®

SPECIFY COLOR: Black or Blue

MODEL NO.	DESCRIPTION	SIZE L x W x H	PRICE EACH	Free with a Uline order of
S-22526	UE Wonderboom	3 x 3 x 4"	\$100	\$1,500+



ENJOY CHILLY FALL NIGHTS

**GET OUTDOORS**

**BIG DADDY PLUSH CHAIR**

Luxurious outdoor chair fit for a king.

- 20" wide cushioned seat. **500 lb. capacity.**
- Water-resistant fabric. Side pocket and cup holder.

**BONFIRE FIRE PIT**

**SOLO STOVE®**

360° Airflow Design™ provides an instant flame.

- Produces less ash and virtually no smoke.
- Bottom and top vents circulate air efficiently.

MODEL NO.	DESCRIPTION	SIZE L x W x H	PRICE EACH	Free with a Uline order of
S-24376	Big Daddy Plush Chair	28 x 35 x 39"	\$120	<b>\$1,500+</b>
H-9277	Bonfire Fire Pit	20 x 20 x 14"	600	<b>\$10,000+</b>

**TABLETOP GRIDDLE**

**BLACKSTONE**



Feed the whole crew breakfast, lunch and dinner.

- Steel flat-top cooking surface. 2 independent burners.
- Powder-coated steel exterior. Portable and easy to clean.
- 8-piece professional cleaning kit included.

ETL/C-ETL Listed

MODEL NO.	GRILLING SURFACE	OVERALL SIZE L x W x H	BTU	WT. (LBS.)	PRICE EACH	Free with a Uline order of
H-10884	22"	23 x 21 x 9"	24,000	38	\$230	<b>\$5,000+</b>

Runs on 1 lb. propane cylinder (not included)

SHIPS VIA UPS

**AIR FRYER**

**GOURMIA®**

Enjoy crispy onion rings without frying in oil.

- Air fry, bake, roast, reheat and more.
- Elegant design with stainless steel accents.
- Simple touch screen with 12 cooking presets.
- Dishwasher safe 8-quart basket and crisper tray.



ETL/C-ETL Listed

MODEL NO.	DESCRIPTION	SIZE L x W x H	CAP. (QT.)	PRICE EACH	Free with a Uline order of
H-10898	Air Fryer	13 x 14 x 15"	8	\$120	<b>\$2,500+</b>

**DELUXE STEAK KNIFE SET**



Slice right through juicy T-bone and tomahawk steaks.

- High-carbon stainless steel blade with finger notch.
- Razor-sharp edge with 1½" serrated tip.
- Triple-riveted handle design for extra stability.

MODEL NO.	DESCRIPTION	PRICE PER SET	Free with a Uline order of
H-10105	Deluxe Steak Knife Set of 4	\$50	<b>\$750+</b>

**COUNTRY COMBO**

Lodge Cast Iron Skillet – Seasoned and ready to use.

- Provides even heat and great sear.
- Triple-wall insulated. Slider lid. Non-slip bottom.



MODEL NO.	DESCRIPTION	PRICE EACH	Free with a Uline order of
H-10908	Combo – 1 Skillet, 1 Yellowstone™ Tumbler	\$110	<b>\$1,500+</b>



**YETI® OUTDOOR ESSENTIALS**



20 OZ. RAMBLER®

30 OZ. RAMBLER® – SET OF 2

SOFT-SIDED COOLER

Rambler® – Drinks stay hot or cold longer. Double-wall insulated stainless steel.

Rambler® Set – 50% larger for all-day sipping. Double-wall insulated stainless steel.

Soft-Sided Cooler – Keep the duck you shot cold all weekend. Holds 20 12-oz. cans and ice.

MODEL NO.	DESCRIPTION	SIZE	PRICE EACH	Free with a Uline order of
S-22057	Rambler®	20 oz.	\$45	\$750+
S-23179	Rambler® Set of 2	30 oz.	100	\$1,500+
S-25466	Soft-Sided Cooler	24 qt.	325	\$7,500+

**FLANNEL SHIRT JACKETS**



Cozy up to cold weather in style and comfort.

- Soft flannel with warm, Sherpa fleece lining.
- Buttoned front. 2 chest and 2 side pockets.
- Machine washable.

COLEMAN® SPECIFY COLOR: Red Plaid, Gray Plaid or Green Plaid

MODEL NO.	DESCRIPTION	SIZE	PRICE EACH	Free with a Uline order of
S-24264	Flannel Shirt Jacket	L - 2XL	\$60	\$750+

Imported

**LAMB'S WOOL THROWS**

A customer favorite. For home or your cabin in the woods.

- Reversible microfur with super soft faux lamb's wool.
- A living room essential.
- Machine washable.



SPECIFY COLOR: Blue Check, Red Check, Brown Plaid, Gray-Red, Camo, White, Navy or Gray

MODEL NO.	DESCRIPTION	SIZE	PRICE EACH	Free with a Uline order of
S-15965	Lamb's Wool Throw	50 x 60"	\$45	\$500+

Imported

**UTILITY WAGONS**



The ultimate pack and play wagon for adults.

- Folds to 15% of its size.
- Polyester with steel frame.
- Large 7" wheels. 180 lb. capacity.

SPECIFY COLOR: Red or Blue

MODEL NO.	DESCRIPTION	SIZE L x W x H	WT. (LBS.)	PRICE EACH	Free with a Uline order of
S-21433	Utility Wagon	36 x 19 x 22"	26	\$85	\$1,000+

**WEBER® GRILL**

The brand that sets the barbecue standard.

- Traditional backyard charcoal grill.
- Porcelain enamel bowl and lid.
- Aluminum vent and ash catcher.



MODEL NO.	DESCRIPTION	GRILLING SURFACE	PRICE EACH	Free with a Uline order of
H-3554	Original Kettle™ Grill	22"	\$175	\$2,500+

SHIPS UNASSEMBLED VIA UPS



**ULINE**12575 Uline Drive  
Pleasant Prairie, WI 53158**THREE WAYS TO ORDER****Phone** 1-800-295-5510**Fax** 1-800-295-5571**Online** uline.comPRSRTP BPM  
U.S. POSTAGE  
PAID  
**ULINE**

OR CURRENT OCCUPANT

CUSTOMER #

PRIORITY CODE

**HUGE INVENTORY IN STOCK IN 13 LOCATIONS****SAME DAY SHIPPING****1-800-295-5510**

uline.com

Bags 112-199, 740-747, 797

Boxes 4-85, 172-184, 192-193

Bubble 763-772, 740-744, 50-51

Foam 772-789, 742, 748-749

**Free Offers 862-867****Index 853-861**

Janitorial 317-417

Labels 234-275, 219, 223-225

Mailers 74-108, 173, 748-749

Material Handling 418-645, 656

Office Furniture 536-561, 630-634

Paper Cushioning 782-791, 780, 796

Peanuts 780-781

Retail 160-225

Safety/Gloves 670-739, 576-605

Strapping 298-313

Stretch Wrap 286-297, 798

Tape 803-851, 138, 276

Tubes 86-91, 97

©2023 Uline

**CAST STRETCH WRAP**Our best-selling stretch film.  
We tested many cast films before  
choosing our Uline house film.

- Comes off the roll smoothly and quietly.

**IN STOCK – SHIPS TODAY****80 GAUGE** – For loads up to 2,500 lbs.

MODEL NO.	SIZE	PRICE PER ROLL (4 ROLLS/CASE)			
		4	8	16	24+
S-2189	15" x 1,500'	\$23	\$22	\$21	\$20
S-2190	18" x 1,500'	\$21 per roll any case quantity			

ORDER IN CASE QUANTITIES



POLY BAGS



STRAPPING



TAPE